



Implementation Guide

to the

Postsecondary Electronic Standards Council

XML Standard Format

for the

High School Transcript

Version 1.0.2

December 5, 2007

Send corrections and comments to:

Tom Stewart
stewartj@aol.com

Table of Contents

<u>Page</u>	
v	Introduction
v	Organization and Format
ix	Development History and Acknowledgments
1	High School Transcript
2	TransmissionData
5 Source
6---- Organization
9----- LocalOrganizationID
10----- Contacts
12----- Address
15----- Phone
16----- Email
17----- URL
18 Destination
19---- Organization
23----- LocalOrganizationID
24----- Contacts
26----- Address
29----- Phone
30----- Email
31----- URL
32	Student
34 Person
37---- Birth
39---- Name
41---- AlternateName
43---- ParentGuardianName
45---- Contacts
47----- Address
50----- Phone
51----- Email
52----- URL
53---- Gender
54---- RaceEthnicity
55---- Deceased
56 AcademicRecord
58---- School
61----- LocalOrganizationID
62----- Contacts
64----- Address
67----- Phone
68----- Email

Table of Contents

<u>Page</u>	
69 ---- --- URL
70 ---- StudentLevel
71 ---- AcademicAward
74 ---- AcademicHonors
75 ---- AcademicAwardProgram
77 ---- --- ProgramSummary
80 ---- --- GPA
82 ---- --- AcademicHonors
83 ---- AcademicDegreeRequirement
84 ---- AcademicSummary
87 ---- --- GPA
89 ---- --- AcademicHonors
90 ---- --- AcademicProgram
92 ---- AcademicSummary
95 ---- GPA
97 ---- AcademicHonors
98 ---- AcademicProgram
100 ---- AcademicSession
102 ---- AcademicSessionDetail
104 ---- School
108 ---- ---- LocalOrganizationID
109 ---- --- Contacts
111 ---- --- Address
114 ---- --- Phone
115 ---- --- Email
116 ---- --- URL
117 ---- StudentLevel
118 ---- AcademicProgram
120 ---- --- ProgramSummary
124 ---- --- GPA
126 ---- --- AcademicHonors
127 ---- AcademicAward
130 ---- --- AcademicHonors
131 ---- --- AcademicAwardProgram
133 ---- --- ProgramSummary
136 ---- --- --- GPA
138 ---- --- --- AcademicHonors
139 ---- --- AcademicDegreeRequirement
140 ---- --- AcademicSummary
143 ---- --- GPA
145 ---- --- AcademicHonors
146 ---- --- AcademicProgram

Table of Contents

Page

148 ---- **Course**

156 ---- --- CourseOverrideSchool

160 ---- ---- LocalOrganizationID

161 ---- --- Contacts

163 ---- --- --- Address

166 ---- --- --- Phone

167 ---- --- --- Email

168 ---- --- --- URL

169 ---- --- Requirement

171 ---- --- Attribute

173 ---- --- Proficiency

175 ---- --- Licensure

176 ---- --- LanguageOfInstruction

177 ---- **AcademicSummary**

181 ---- --- GPA

183 ---- --- AcademicHonors

184 ---- --- AcademicProgram

186 ---- **Course**

194 ---- **CourseOverrideSchool**

197 ---- ---- LocalOrganizationID

198 ---- --- Contacts

199 ---- --- Address

202 ---- --- Phone

203 ---- --- Email

204 ---- --- URL

205 ---- **Requirement**

207 ---- **Attribute**

209 ---- **Proficiency**

211 ---- **Licensure**

212 ---- **LanguageOfInstruction**

213 ---- **AdditionalStudentAchievements**

215 ---- **Requirement**

217 ---- **Attribute**

219 ---- **Proficiency**

221 ---- **Language**

222 ---- **Licensure**

223 **Health**

224 ---- **Immunizations**

225 **Tests**

227 ---- **StudentLevel**

228 ---- **Subtest**

229 ---- **TestScores**

Table of Contents

<u>Page</u>	
231	<i>Appendix A – State and Province Codes</i>
233	<i>Appendix B – Country Codes</i>
247	<i>Appendix C – Test Codes and Test Names</i>
248	<i>Appendix D – Subtest Codes and Subtest Names</i>
256	<i>Appendix E – Course Academic Grade Scale Codes</i>
261	<i>Appendix F – Sample XML High School Transcript</i>
274	<i>Appendix G – Language Codes (ISO)</i>
308	<i>Appendix H – History of Changes to High School Transcript Schemas and Guides</i>
309	<i>Appendix J – Members of the PESC XML High School Transcript Workgroup</i>

Introduction

For the secondary and higher education communities to achieve the timely, uniform, accurate, and secure exchange of academic records for current or previous secondary students, the Postsecondary Electronic Standards Council (PESC) has developed and seeks approval for a standard format in eXtensible Markup Language (XML) for the High School Transcript. This Draft Implementation Guide proposes a format for electronically exchangeable high school records and can help non-technical users to implement the electronic records exchange process.

Besides its obvious use for secondary and postsecondary educational institutions, this Guide should also be useful for software vendors and state and federal education agencies.

Secondary educational institutions use high school transcripts to transmit current and historical student academic records to postsecondary educational institutions. When a student intends to transfer from a secondary school to a postsecondary school, it is essential that the student’s academic record be made available to the receiving school as quickly as possible so that the receiving institution can make a faster admissions decision. In addition, the prompt transmission of the secondary school academic record allows the receiving institution to evaluate the record in a more timely fashion and thereby to advise the student on the applicability of past courses to current program requirements.

The secondary student transcript contains personal history and identifying information about the student, the current academic status, dates of attendance, courses completed with grades earned, diplomas and certificates awarded, and selected test scores.

This Implementation Guide is based on the Approved PESC XML High School Transcript Schema version 1.0.0. It uses the Academic Record Sector Library Version 1.1.0 and Core Main Version 1.2.0. For the electronic exchange of these student records to be completely automated, it is essential that all users adhere strictly to the requirements of this Schema and understand and comply with the requirements outlined in this Guide. Although not required in the Schema, this Implementation Guide also makes recommendations for acceptable practice based on “The Academic Record and Transcript Guide,” a publication by the American Association of Collegiate Registrars and Admissions Officers (AACRAO).

Organization and Format

The schema for the High School Transcript is made up of four main parts:

- 1. Transmission Data
- 2. Student
- 3. Note Message
- 4. User Defined Extensions

However, three of these main parts branch to form other parts, which in turn branch out further. This Guide is organized so that each level of branching is documented in the order as follows:

- Transmission Data Level I
 - Sub-level IA
 - Sub-level IA1
 - Sub-level IA1a
 - Sub-level IA1b
 - Sub-level IA2
 - Sub-level IA2a
 - Sub-level IA2b
 - Sub-level IB
 - Sub-level IB1
 - Sub-level IB1a
- Student Data Level I
- (Etc.)

The heading for each level and sub-level indicates the position of the subsequent diagram in the larger Schema.

Following the heading, the diagram serves to illustrate its relationship with the preceding branch. All diagrams in this Guide were copied from a graphical representation of the High School Transcript Schema using a software package from Altova Corporation called XMLSpy.

Example:

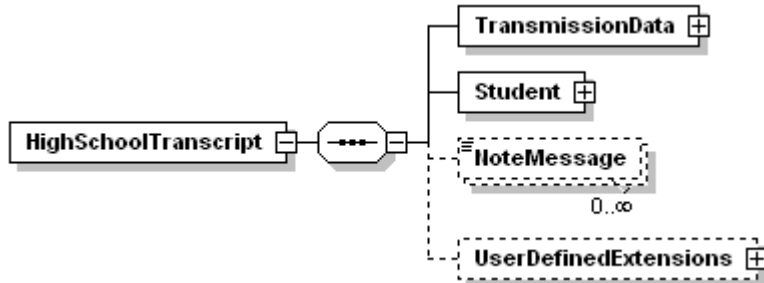

The boxes in the diagrams can illustrate two separate components of the Schema: first, certain boxes show data element groupings which branch out to form either lower-level element groupings, or the Schema’s other primary component, the fields that contain actual data. A box with a solid border indicates that that particular data element or field is required. A box with a dotted line indicates an optional data element or field. Likewise, a solid line connecting two or more boxes indicates that the boxes to the right in the diagram are required fields and a dotted line indicates the fields in the boxes to the right are optional. A plus (+) sign at the right of a box indicates that the element grouping or field branches beyond the scope of a given diagram. The Schema displays such branching in subsequent diagrams.

Each diagram includes a representation of a field or data element’s repeatability. Under a given box, for example, “0...∞” would indicate an optional data element or field (with a minimum number of occurrences of zero) that can be repeated an infinite number of times. On the other hand, “1...3” would indicate a mandatory field (with at least one required instance) that can be repeated up to 3 times.

Although most data elements that could theoretically be included an infinite number of times in the schema, would typically only be included once or perhaps a few times. Including a high number of occurrences of a field would present problems for the receiving agency or institution.

Under each diagram, a table will appear with five columns:

Tag Name: This is the name of the data element grouping or field that will appear in the Schema and in the instance document. (“Instance document” refers to a transcript with real data for an actual student that institutions would exchange.) The format for the tag name is Upper Camel Case which takes a name such as “Transmission Data” and eliminates the space between the two words, retaining the capital letters of each word making up the tag name.

Schema Use: This column indicates whether the data element or field is required or optional in the instance document. If a required field is not included in the instance document, the transcript will normally be rejected by the receiving institution or agency’s computer program (XML Parser). This column will also include a notation if a field can be sent multiple times.

Description: This is a brief description of the data included with a particular XML tag name. The description normally comes from the description in the Core Main Schema for data elements.

Recommended Use: This column reflects recommendations from the developers of the High School Transcript Schema, standards of good practice as defined by the AACRAO Transcript Guide, and generally recommended practices for exchanging electronic transcripts. Reaching consensus on the recommended use of data elements and fields has grown into an additional task for the PESC Workgroup.

Recommendations in this column generally match the standards in Schema Use, especially if Schema Use shows an element or field as “Required.” However, a component listed as “Optional” in Schema Use may be listed as “Recommended” in Recommended Use if the Workgroup regards the element or field as essential and in keeping with good practices in the AACRAO community.

Required: Indicates that a sending institution must include the data element or field in its transmission.

Recommended: If the information for a field is available at the sending school, then ‘Recommended’ indicates that the field should be sent.

Conditional: This recommended use does not occur often in this Guide, but it may occur when the recommendation (recommended, optional or not recommended) is dependent on another data element being sent, or even on the value of another data element that is sent.

Optional: Indicates that it is generally up to the sender to include the data or not. If a paper transcript normally includes the element or field, then the sender should probably include it. In addition, within certain states, items marked as “Optional” may be essential for intrastate exchanges. Finally, it may be the case that a destination school receives all data at a single location; in such a case, the sender may need to provide optional elements to identify the specific intended recipient.

Not Recommended: Indicates that, in the view of the Workgroup, such a data element or field should not form part of a transmission. In general, the Workgroup recommends that institutions not send notes or comments, since most Student Information System programs cannot automatically process them. Sending these elements could thereby slow or impede automatic processing by the receiving school. However, exceptions to this rule-of-thumb may lie in the needs of individual states, as certain intrastate transmissions may require information that only a note or comment field can accommodate. In such cases, the Workgroup recommends that institutions in the state develop a protocol for maintaining and transmitting the element or field. In other cases, common practice may be to include data that is not recommended by the Workgroup.

In many cases, because of the reusability of complex data elements in XML, there are data elements included in this schema that may not be appropriate for use in the High School Transcript. In these cases, the recommended use may be designated as “Not Recommended.”

Format: This column shows the minimum and maximum number of occurrences of the data element. It also shows the minimum and maximum length allowable for a field, if that field does not have enumerated values and is not a special type of field, such a date field.

“**minOcc 1**” indicates a required field, since it must have at least one occurrence in the instance document. “**minOcc 0**” indicates an optional field.

“**maxOcc**” followed by a number or symbol specifies the maximum number of times that an element can recur in an instance document at a particular position. For example, “maxOcc 5” would indicate that the field may occur no more than 5 times in a given position of the instance document. “maxOcc ∞” indicates that a field may recur an unlimited number of times in the instance document. However, the use of an excessive number of occurrences puts a burden on the receiving agency or institution, so they should always be limited to the fewest number possible.

“**minLength**” indicates the minimum number of characters that a field must contain, while “**maxLength**” indicates the maximum number of characters that a field may contain.

“**Enumeration**” is used to list the allowable values that may be used in the instance document. They must be used exactly as shown in this column. When the values are enumerated in this column, “minLength” and “maxLength” will not be indicated and are not appropriate.

“**DateTime**” always uses the same format: ccyymm-ddThh:ii:ss(+GMT). An example would be “2005-11-20T08:15:36(+7)”. Likewise, “Date” always uses the format “ccyy-mm-dd”. An example would be “2005-11-20”. If either DateTime or Date is used, then “minLength” and “maxLength” will not be indicated.

“**xs:decimal**” indicates a numeric field. It has a maximum length of 18 characters including a decimal if is explicitly included. Typical values would be (1) a grade point average of “3.250”; (2) credits earned of “24”; or (3) credits included in GPA of “16”.

“**minInclusive**” indicates the lowest value of a decimal type field that can be included, while “**maxInclusive**” indicates the maximum value that can be included in a decimal type field. “**totalDigits**” indicates the maximum number of digits that can be used in the specified field.

Comments: The Guide may include comments beneath the rows of a given table and/or at the end of the table. The Workgroup intends for these comments to provide further explanation for the items displayed.

Code Illustration: Below each table, the Guide includes a snippet of what that portion of an instance document might look like in XML format. If the data element is a required data element for the schema, then that data element will be in **bold** type.

If the code is illustrating a complex data element that will be further explained on a subsequent page, then only the opening and closing tags will be included. For example:

<Course>

</Course>

If the code is illustrating a simple data element that is not recommended for inclusion, then an empty tag will be included. For example:

<NoteMessage/>

Appendix F shows an example of an XML Schema for a high school transcript. This example is not intended to match the Code Illustrations throughout the Guide, since a typical transcript would not include many of the optional sections of the Schema.

Order of Including Data Elements: Although the Schema includes many optional data elements and you may choose not to include them in an instance document, if you do include data elements, they must appear in the same order they appear in the Schema.

NoteMessage: You will find “NoteMessage” appearing throughout the Schema. This Guide almost always recommends against the routine use of note messages. Unless there is an agreed upon format for a note message between the sender and the receiver, notes cannot be interpreted and automatically processed by the receiver’s computer.

UserDefinedExtensions: The user-defined extension (UDE) design pattern is intended to address situations in which the current Schema does not accommodate sender-specific data. The Schema has to allow for additional elements that may be defined and used at a later date. The user-defined extensions pattern serves as a placeholder for these to-be-defined fields and elements. However, it can require that these fields be defined in a Schema by the organization that wants to use the extensions area. Senders should take care not to use the user-defined extensions as a fall-back for doing appropriate research and design. They should only use the extension when in actuality, the organization defining the base Schema cannot define the additional elements that other organizations may need. Furthermore, other recipients not interested in the data these specific organizations want to exchange in the user-defined area, may then just ignore the UDE.

User-defined extensions are beneficial when both the sending and receiving institutions agree on their use. For best work practice, the Workgroup recommends the use of user-defined extensions in the following scope:

- Mutually defined sub-schemas: For the transmittal and receipt of data agreed upon by both sending and receiving institutions;
- State systems: In the California CSU system, this would be the General Education requirements; For the University of California system, this would be the UC requirements;
- Regional requirements

The benefit of using the user-defined extensions stems primarily from the open nature of the XML design. Institutions may take advantage of XML’s openness, use the user-defined extensions to accommodate data for which the original Schema has not accounted, and standardize the use of the extensions among themselves. Such institution-to-institution agreements allow for the following:

- Strict standardization among institutions through design and implementation agreements,
- Ability of users outside of the agreement to ignore the data contained in the user-defined extensions.

Because the Schema recommends that institutions develop their own agreements for the use of user-defined extensions, the Workgroup also recommends against the development of national standards.

Example Code:

```
<UserDefinedExtensions>
  <YearTerm>20042</YearTerm>
  <CourseAbbrev>ENG</CourseAbbrev>
  <CourseNum>0114</CourseNum>
  <SectNum>02</SectNum>
</UserDefinedExtensions>
```

Please reference Excerpt from PESC Guidelines for XML Architecture and Data Modeling page 46 (<http://www.pesc.org/info/policies/PESC-Guidelines-for-XML-Architecture-and-Data-Modeling-v3-0.doc>) for a full explanation on the usage of user-defined extensions.

Development History and Acknowledgments

The American Association of Collegiate Registrars and Admissions Officers (AACRAO) Committee on the Standardization of Postsecondary Education Electronic Data Exchange (SPEEDE) began working on a national standard format for the electronic exchange of postsecondary student records in 1989. Initially the work of the committee was funded by AACRAO. At about the same time, the US Department of Education’s National Center for Education Statistics (NCES) began developing a national standard format for the electronic exchange of student records for kindergarten through high school students. The K12 community was primarily represented by the Council of Chief State School Officers (CCSSO). To gain more credibility in the creation and widespread adoption of the standards, the

two groups (AACRAO and NCES) approached the American National Standards Institute's (ANSI) Accredited Standards Committee (ASC) X12 for assistance in developing and approving the two standard formats.

ASC X12 reviewed the two proposals and insisted that only one standard be developed and approved. That standard would be the Kindergarten through Postsecondary Education Student Record. At that time, NCES decided to fund the travel of the AACRAO SPEEDE Committee as well as those working on the K-12 standard. The ASC X12 Standard in the Electronic Data Interchange (EDI) format was approved in the early 1990's as ANSI ASC X12 Transaction Set 130 for the Student Educational Record (Transcript).

During this time period (before the Internet was widely available), the format stressed the transmission of as much data as possible using the fewest characters. This emphasis emerged because transmission costs were based on the number of characters or bytes being sent over the Value Added Electronic Networks (VANs).

The ASC X12 Standard is now in use by a significant number of postsecondary institutions in the United States and Canada. Approximately 500,000 postsecondary transcripts are exchanged electronically in the EDI format through the University of Texas at Austin Internet Server in the ASC X12 EDI format each year. At the secondary level, Florida schools exchange a significant number of electronic high school transcripts, because the state mandates the exchange in its proprietary format. Iowa and Maryland also have significant exchange. Overall, however, the number of electronic transcript exchanges remains small for secondary schools.

The number of transcripts exchanged electronically in the ASC X12 EDI format grows significantly each year. However, the education community felt that an alternative format should be explored. In the view of many, the perceived complexity of implementing the EDI standards was one of the reasons that many high schools did not use the EDI format.

The Postsecondary Electronic Standards Council (PESC) commissioned this exploration by creating the XML Forum. The Forum had as its purpose to determine if an XML format might result in significantly increased electronic exchange of high school student educational records.

The wide and inexpensive availability of XML software tools and the already existing and pervasive use of XML by many schools' information technology staffs made the XML process appear to have a much better chance of rapid acceptance and implementation by postsecondary educational institutions.

The early efforts of the XML Forum emphasized the creation of standard reusable core components. Once the Forum made significant progress with this work, PESC agreed to develop an XML Standard Format for the College Transcript to demonstrate that this could be done.

Bruce Marton from the University of Texas at Austin headed this effort and received the bulk of his support from the AACRAO SPEEDE Committee that had developed the earlier EDI standard.

PESC approved the XML standard for the College Transcript in May 2004.

The approval of the XML College Transcript generated considerable interest in the creation of an XML High School Transcript. Bruce Marton reviewed the ANSI ASC X12 EDI version of the transcript, which included both the College Transcript and the High School Transcript and noted many similarities.

Under Bruce's leadership, the AACRAO SPEEDE Committee created a very rough draft of a proposed schema for an XML High School Transcript in late summer of 2004.

The October 2004 PESC Meeting in Newport Beach, California, included a session on the draft XML High School Transcript Schema. Attendees expressed significant interest, and some formed an informal PESC Workgroup to review the draft and determine if it could be used to accelerate the development of a PESC XML High School Transcript.

The Workgroup began holding weekly conference calls and enhanced the rough draft from the end of 2004 through May 2005. PESC then sent out a press release to the wider educational community and invited anyone interested to participate in a special conference call on May 26, 2005. There were thirty-nine participants on that call. Many agreed to join the Workgroup and participate in future calls.

The Workgroup decided to continue the weekly calls at least through 2005 and subsequently to post the XML Schema on the PESC web site for review by a wider audience. To assist in that review, the Workgroup has prepared this draft of an Implementation Guide.

The Workgroup completed its work in January 2006 and submitted a request for approval to the PESC Change Control Board. The PESC CCB approved the request and PESC posted the proposed schema and the draft Implementation Guide on the PESC web site for a 30 day comment review. As a result of the review, eight comments were received. These comments were addressed by the Workgroup and the responses by the Workgroup were submitted to the PESC CCB for approval. These responses were approved by the PESC CCB on May 15, 2006 and the CCB requested that the PESC membership vote to approve the XML High School Transcript Schema as a PESC national standard.

This vote was held and the PESC voting membership approved the XML High School Transcript as a PESC Standard on June 9, 2006.

This revision of the Implementation Guide was created primarily to correct the sample instance document in Attachment F which had multiple errors. It also corrects some of the schema diagrams throughout the document. Other cosmetic changes were made as well.

High School Transcript

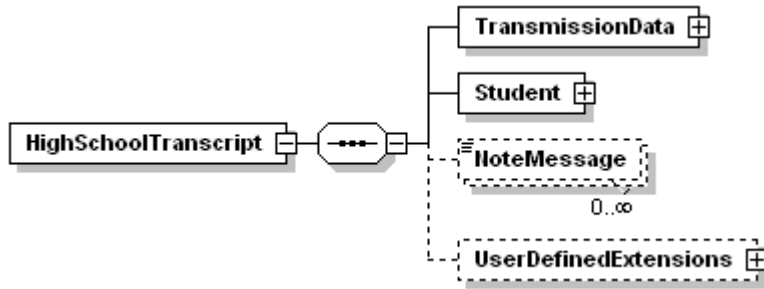

Tag Name	Schema Use	Description	Recommended Use	Format
TransmissionData	Required	Routing and header information	Required	minOcc 1 maxOcc 1
Student	Required	Body of document. One segment per student	Required	minOcc 1 maxOcc 1
NoteMessage	Optional Repeatable	Additional information about transcript	Not recommended	minOcc 0 maxOcc ∞ minLength 1 maxLength 80
UserDefinedExtensions	Optional	Additional structured information. Requires mutually defined XML schema.	Optional	minOcc 0 maxOcc 1

Comment: The High School Transcript Schema can only contain information about one student. However, you can include instance documents for multiple students by using the PESC Schema for Batch Submittal which is available on the PESC web site at www.PESC.org.

Code illustration:

```

<HSTrn:HighSchoolTranscript
  XMLNs:HSTrn="urn:org:pecs:message:HighSchoolTranscript:v1.0.0"
  XMLNs:AcRec="urn:org:pecs:sector:AcademicRecord:v1.0.0"
  XMLNs:core="urn:org:pecs:core:CoreMain:v1.0.0"
  XMLNs:xsi="http://www.w3.org/2001/XMLSchema-instance"
  xsi:schemaLocation="urn:org:pecs:message:HighSchoolTranscript:v1.0.0
/HighSchoolTranscript_v1.0.0.xsd">
  <TransmissionData>

  </TransmissionData>
  <Student>

  </Student>
  <NoteMessage />
  <UserDefinedExtensions />
</HSTrn:HighSchoolTranscript>
    
```

TransmissionData

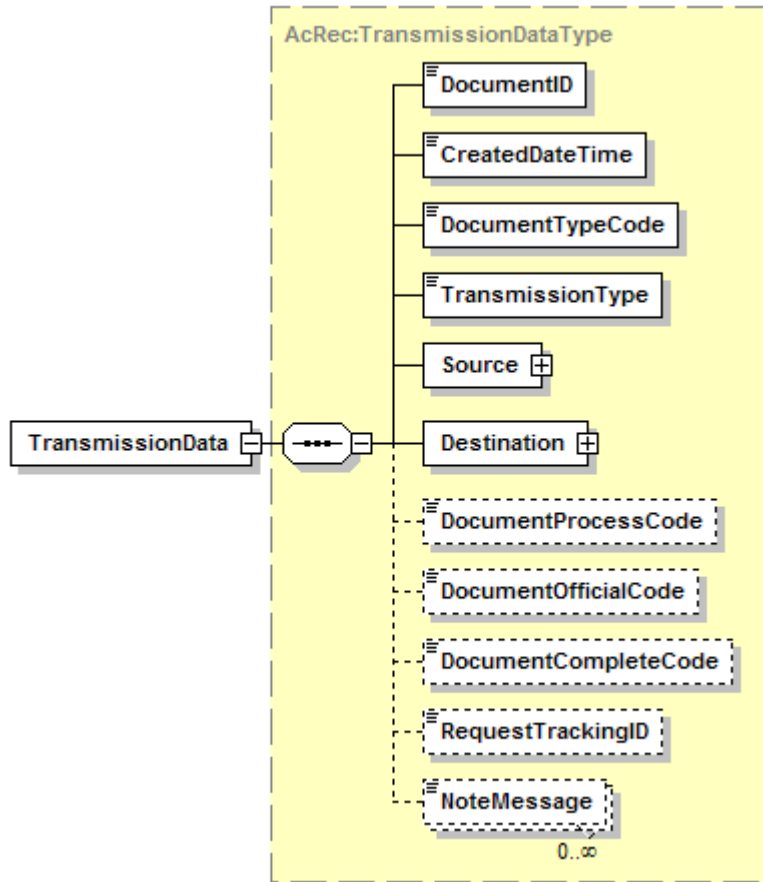

Tag Name	Schema Use	Description	Recommended Use	Format
DocumentID	Required	The File Transmission Date and Time stamp with additional unique qualifying characters	Required	minOcc 1 maxOcc 1 minLength 1 maxLength 35
CreatedDateTime	Required	The Date and Time stamp when the document was created	Required	minOcc 1 maxOcc 1 xs:datetime cyy-mm-ddThh:ii:ss{+-GMT}
DocumentTypeCode	Required	Type and purpose of document being transmitted	Required	minOcc 1 maxOcc 1 Enumerations: Change InstitutionRequest RequestedRecord StudentRequest TermEnroll TermGrade ThirdPartyRequest

Comment: "Change" would be an appropriate value if the transcript had previously been sent and this is a corrected or updated transcript. "Institution Request" would be appropriate if this transcript is being sent at the request of a postsecondary institution to which the student has applied for admission. "Term Enroll" and "Term Grade" would not be typical values for this data element.

Tag Name	Schema Use	Description	Recommended Use	Format
TransmissionType	Required	The nature of the Transmission	Required	minOcc 1 maxOcc 1 Enumerations: Original Replace Duplicate Resubmission Reissue MutuallyDefined
Source	Required	This field is required and essential to indicate the source of the High School Transcript being sent. It is normally the sending high school where the student enrolled for courses.	Required	minOcc 1 maxOcc 1
Comment: This complex data element will be expanded on page 5 which follows.				
Destination	Required	This field is mandatory and essential to indicate the destination or recipient of the high school transcript being sent.	Required	minOcc 1 maxOcc 1
Comment: This complex data element will be expanded on page XXX which follows.				
DocumentProcessCode	Optional	This element indicates a TEST or PRODUCTION document	Required if "TEST"; "PRODUCTION" implied, not recommended	minOcc 0 maxOcc 1 Enumerations: TEST PRODUCTION
DocumentOfficialCode	Optional	This element indicates if the document is unofficial. Unofficial documents may be produced for reference purpose but may not be binding.	Required if Unofficial; "Official" implied, not recommended	minOcc 0 maxOcc 1 Enumerations: Official Unofficial
Comment: With paper transcripts, it is normal practice for the recipient to decide if the transcript received is to be considered official or unofficial. With electronic transcripts exchanged through a secure process such as the University of Texas at Austin SPEEDE Server, most recipients would consider them official. In some states, based on a prior agreement, some optional data elements that are not sent for official transcripts may be included in unofficial transcripts.				
DocumentCompleteCode	Optional	This element indicates whether the document conveys a complete record. Partial documents may be produced for information that is recorded in multiple media or formats. If the student is still enrolled at the high school, but the record being sent includes all the available information to date for that student, then the record would be considered complete, and this data element would not be included in the transcript. A value of Partial generally means that the remainder will be sent in hard copy.	Required if not complete; "Complete" is implied, not recommended	minOcc 0 maxOcc 1 Enumerations: Partial Complete
RequestTrackingID	Optional	The unique ID associated with a request action that is returned to the requestor for document matching and tracking.	Optional	minOcc 0 maxOcc 1 minLength 1 maxLength 35
NoteMessage	Optional Repeatable	Additional information about transmission	Not recommended	minOcc 0 maxOcc ∞ minLength 1 maxLength 80

Code illustration:

```
<TransmissionData>
  <DocumentID>2316139</DocumentID>
  <CreatedDateTime>2004-04-04T09:30:47-05:00</CreatedDateTime>
  <DocumentTypeCode>Requeste</DocumentTypeCode>
  <TransmissionType>Original</TransmissionType>
  <Source>

  </Source>
  <Destination>

  </Destination>
  <DocumentProcessCode />
  <DocumentOfficialCode />
  <DocumentCompleteCode />
  <RequestTrackingID />
  <NoteMessage />
</TransmissionData>
```

TransmissionData.Source

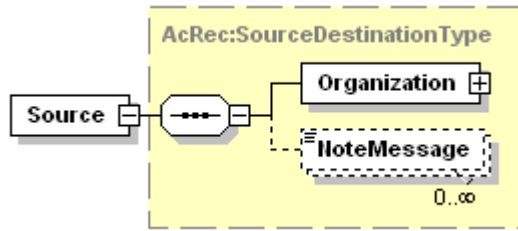

Tag Name	Schema Use	Description	Recommended Use	Format
Organization	Required	Non-person entity such as Organization, Institution, Agency or Business.	Required	minOcc 1 maxOcc 1
Comment: This complex data element will be expanded on page 6 which follows.				
NoteMessage	Optional Repeatable	Additional information about Organization	Not recommended	minOcc 0 maxOcc ∞ minLength 1 maxLength 80
Comment: This gives information about the sending or source high school.				

Code illustration:

```

<Source>
  <Organization>

  </Organization>
  <NoteMessage />
</Source>
    
```

TransmissionData.Source.Organization

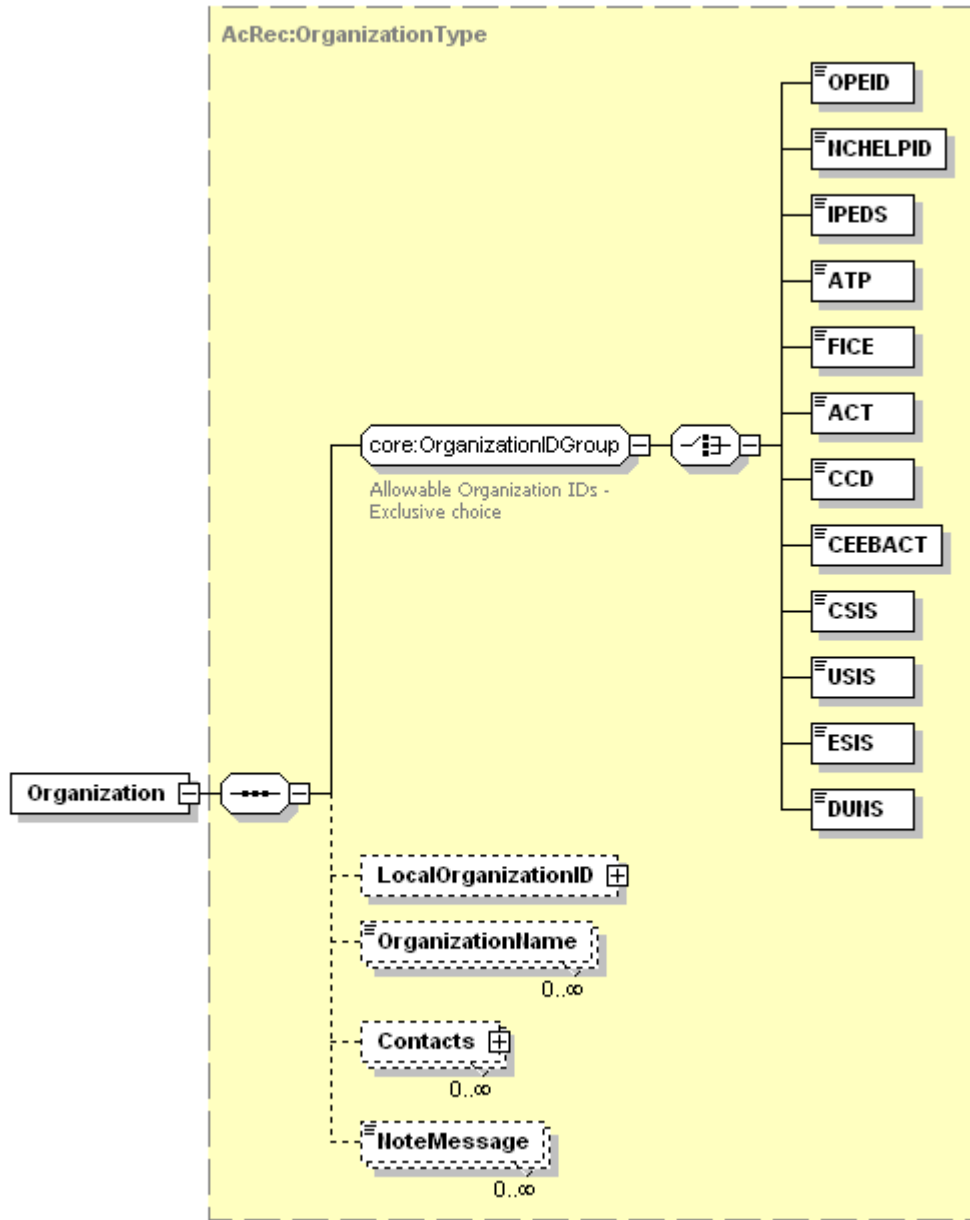

Tag Name	Schema Use	Description	Recommended Use	Format
[OrganizationIDGroup]	Required	Allowable Organization IDs - Exclusive choice	Required	minOcc 1 maxOcc 1
Comment: [OrganizationIDGroup] is not an XML tag and does not appear in an instance document. It requires the choice of one and only one of the following code set tags to identify the institution/organization.				
OPEID	Required choice	The unique identifier assigned by the Office of Postsecondary Education for each data exchange partner.	Not Recommended	minOcc 0 maxOcc 1 minLength 3 maxLength 8
Comment: The OPEID would not normally be an appropriate choice in this case since high school transcripts are not normally generated by postsecondary institutions.				

Tag Name	Schema Use	Description	Recommended Use	Format
NCHELPID	Required choice	The unique identifier assigned by National Council on Higher Education Loan Programs for each data exchange partner.	Not Recommended	minOcc 0 maxOcc 1 minLength 3 maxLength 8
Comment: The NCHELPID would not normally be an appropriate choice in this case since high school transcripts are not normally generated by the financial aid world.				
IPEDS	Required choice	The unique identifier for Integrated Postsecondary Education Data System assigned by the National Center for Education Statistics for each postsecondary data exchange partner.	Not Recommended	minOcc 0 maxOcc 1 minLength 6 maxLength 6
Comment: The IPEDS would not normally be an appropriate choice in this case since high school transcripts are not normally generated by postsecondary institutions.				
ATP	Required choice	The unique identifier for the Admissions Testing Program assigned by the College Board for each data exchange partner.	Not Recommended	minOcc 0 maxOcc 1 minLength 6 maxLength 6
Comment: Since ATP codes are normally issued only to postsecondary institutions, the use of this code to identify a secondary school is not recommended.				
FICE	Required choice	The unique identifier once maintained for the Federal Interagency Committee on Education by the National Center for Education Statistics for each postsecondary data exchange partner.	Not Recommended	minOcc 0 maxOcc 1 minLength 6 maxLength 6
Comment: Although the FICE code set is still widely used by many postsecondary institutions, it has not been maintained by NCES or anyone else since late in the last century. Therefore, codes for new institutions created since then, have been locally assigned and cannot be relied upon. Since FICE codes were normally issued only to postsecondary institutions, the use of this code to identify a secondary school is not recommended.				
ACT	Required choice	The unique identifier for postsecondary educational institutions assigned by American College Testing available at www.act.org	Not Recommended	minOcc 0 maxOcc 1 minLength 4 maxLength 4
Comment: Since ACT codes are normally issued only to postsecondary institutions, the use of this code to identify a secondary school is not recommended.				
CCD	Required choice	The unique identifier assigned by National Center for Education Statistics as the Common Core of Data for each data exchange partner.	Required choice Recommended	minOcc 0 maxOcc 1 minLength 12 maxLength 12
Comment: The CCD is a recommended choice to identify secondary school senders.				
CEEBACT	Required choice	The unique identifier assigned by the College Entrance Examining Board and ACT for each K-12 data exchange partner.	Required choice Recommended	minOcc 0 maxOcc 1 minLength 6 maxLength 6
Comment: The CEEBACT code set is a preferred choice to identify secondary school senders.				
CSIS	Required choice	The unique identifier assigned by the Statistics Canada Canadian College Student Information System for each postsecondary data exchange partner.	Not Recommended	minOcc 0 maxOcc 1 minLength 6 maxLength 6
Comment: Since this code set is used to identify postsecondary schools in Canada, it is not a recommended choice for high schools in the United States. It would be an appropriate choice for high schools in Canada.				

Tag Name	Schema Use	Description	Recommended Use	Format
USIS	Required choice	The unique identifier assigned by the Statistics Canada University Student Information System for each data postsecondary exchange partner.	Not Recommended	minOcc 0 maxOcc 1 minLength 6 maxLength 6
Comment: Since this code set is used to identify postsecondary schools in Canada, it is not a recommended choice for high schools in the United States. It would, however, be an appropriate choice for high schools in Canada.				
ESIS	Required choice	The unique identifier assigned by the Statistics Canada Enhanced Student Information System for each data postsecondary exchange partner.	Not Recommended	minOcc 0 maxOcc 1 minLength 8 maxLength 8
Comment: The ESIS number would not be a normal choice to identify the sending high school that created a High School Transcript in Canada. Neither would it be an appropriate choice for a high school in the United States.				
DUNS	Required choice	Data Universal Numbering System (DUNS), unique nine character company identification number issued by Dun and Bradstreet Corporation.	Not Recommended	minOcc 0 maxOcc 1 minLength 9 maxLength 9
Comment: The DUNS number would not be a normal choice to identify the sending school that created a High School Transcript.				
Comment: End of OrganizationIDGroup choice set tags				
LocalOrganizationID	Optional	A code set typically used by a state, province or region to further identify the sending school.	Optional	minOcc 0 maxOcc 1
Comment: This complex data element will be expanded on page XXX which follows.				
OrganizationName	Optional Repeatable	Name of Non-person entity such as Organization, Institution, Agency or Business.	Recommended	minOcc 0 maxOcc ∞ minLength 1 maxLength 60
Comment: This is the name of the sending high school.				
Contacts	Optional Repeatable	To identify a person or an office at the sending school to which administrative communications should be directed	Recommended	minOcc 0 maxOcc ∞
NoteMessage	Optional Repeatable	Additional information about the organization	Not recommended	minOcc 0 maxOcc ∞ minLength 1 maxLength 80

Code illustration:

```

<Organization>
  <CEEBACT>440320</CEEBACT>
    <LocalOrganizationID>

      </LocalOrganizationID>
    <OrganizationName>Austin High School</OrganizationName>
    <OrganizationName>Austin Independent School District</OrganizationName>
  <Contacts>

    </Contacts>
  <NoteMessage />
</Organization>

```

TransmissionData.Source.Organization.LocalOrganizationID

Note: Although the complex data element LocalOrganizationID is an optional data element, if you choose to send LocalOrganizationID, then you must send both LocalOrganizationIDCode and also LocalOrganizationIDQualifier.

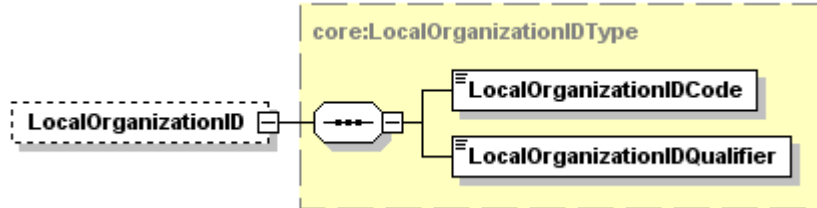

Tag Name	Schema Use	Description	Recommended Use	Format
LocalOrganizationIDCode	Required	The code assigned for the sending school by the state, province or other mutually defined agency specified in the LocalIDQualifier that follows.	Required	minOcc 1 maxOcc 1 minLength 1 maxLength 35
<p>Comment: This is a required data element only if the Local Organization ID complex data element is sent. This is typically the administrative school code assigned by a state or province to specifically identify the sending school in that state. If it is not assigned by a state or province, then code ZZ should be used in the Local ID Qualifier that follows.</p>				
LocalOrganizationIDQualifier	Required	This is the state, province or other mutually defined agency that assigned the Local D Code above.	Required	minOcc 1 maxOcc 1 Enumerations: See Code Set in Appendix A
<p>Comment: This is a required data element only if the Local Organization ID data element is sent. This is typically the state or province that assigned the code to specifically identify the sending school in that state. If it is not assigned by a state or province, then code ZZ should be used in this data element.</p>				

Code illustration:

```
<LocalOrganizationID>
  <LocalOrganizationIDCode>2237901002</LocalOrganizationIDCode>
  <LocalOrganizationIDQualifier>TX</LocalOrganizationIDQualifier>
</LocalOrganizationID>
```

TransmissionData.Source.Organization.Contacts

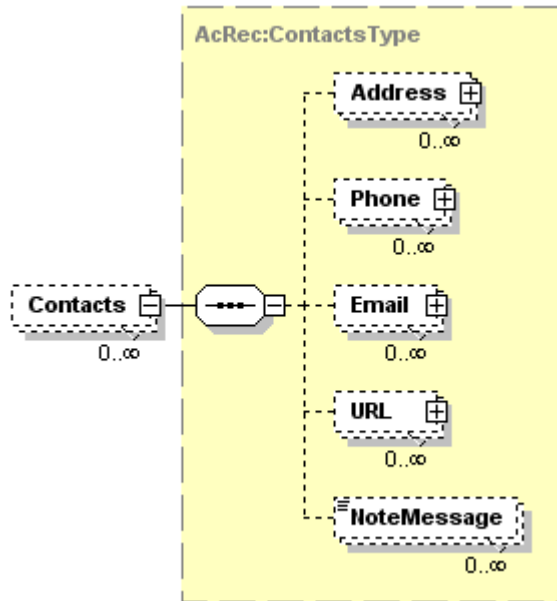

Tag Name	Schema Use	Description	Recommended Use	Format
Address	Optional Repeatable	This is a combined Address Group for a choice between Domestic or International	Recommended	minOcc 0 maxOcc ∞
Comment: This complex data element will be expanded on page XXX which follows.				
Phone	Optional Repeatable	Phone number of source institution contact	Recommended	minOcc 0 maxOcc ∞
Comment: This complex data element will be expanded on page XXX which follows.				
Email	Optional Repeatable	Email address of source institution contact	Recommended	minOcc 0 maxOcc ∞
Comment: This complex data element will be expanded on page XXX which follows.				
URL	Optional Repeatable	The Uniform Resource Locator of source institution	Optional	minOcc 0 maxOcc ∞
Comment: This complex data element will be expanded on page XXX which follows.				
NoteMessage	Optional Repeatable	Additional information about the contacts at the source institution	Not recommended	minOcc 0 maxOcc ∞ minLength 1 maxLength 80
Comment: This is contact information included by the sending high school to indicate the preferred means for the receiving school to contact the sending school in case there is a need for further communication. This is the only place in the instance document to include the name, address and contact information about the school that is sending the transcript.				

TransmissionData.Source.Organization.Contacts (Continued)

Code illustration:

```
<Contacts>  
  <Address>  
  
    </Address>  
    <Phone>  
  
    </Phone>  
    <Email>  
  
    </Email>  
    <URL>  
  
    </URL>  
  <NoteMessage />  
</Contacts>
```

TransmissionData.Source.Organization.Contacts.Address

Note: Although the complex data element Address is an optional data element, if you choose to send the Address of Contacts at the Source Institution, then you must send AddressLine and City and also StateProvinceCode, and PostalCode OR CountryCode.

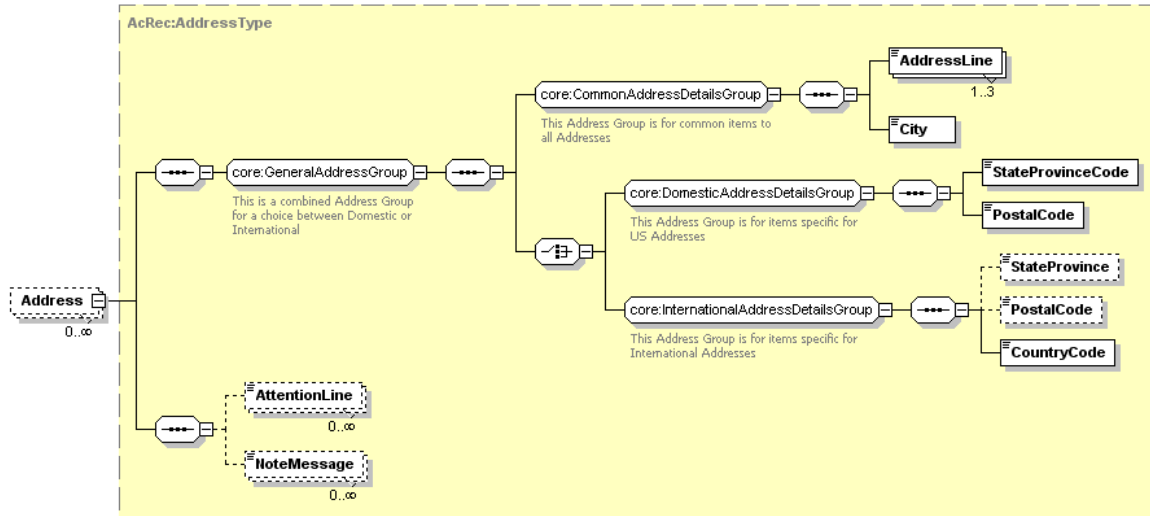

Tag Name	Schema Use	Description	Recommended Use	Format
<i>GeneralAddressGroup</i>	Required	This Address Group is for items common to all Addresses	Required	minOcc 1 maxOcc 1
Comment: [<i>GeneralAddressGroup</i>] does not appear in the instance document. It requires the use of <i>CommonAddressDetailsGroup</i> and the choice of one of either <i>DomesticAddressDetailsGroup</i> or <i>InternationalAddressDetailsGroup</i> . This group is required in the schema only if you choose to send the address of the contact.				
<i>CommonAddressDetailsGroup</i>	Required	This Address Group is for items common to all Addresses	Required	minOcc 1 maxOcc 1
Comment: [<i>CommonAddressDetailsGroup</i>] does not appear in the instance document. If the address of a contact is included in the transcript, then this must be sent. It is required and must be paired with one of either <i>DomesticAddressDetailsGroup</i> or <i>InternationalAddressDetailsGroup</i> .				
<i>AddressLine</i>	Required Repeatable	Local delivery information such as street, building number, PO box, or apartment portion of a postal address of a Contact at the Sending (Source) High School.	Required	minOcc 1 maxOcc 3 minLength 1 maxLength 40
<i>City</i>	Required	The city portion of the Address of a Contact at the Sending (Source) High School.	Required	minOcc 1 maxOcc 1 minLength 2 maxLength 30
<i>DomesticAddressDetailsGroup</i>	Required choice	This Address Group is for items specific for US and Canadian Addresses	Required for domestic addresses	minOcc 1 maxOcc 1
Comment: [<i>DomesticAddressDetailsGroup</i>] does not appear in the instance document. If the complex data element address has a United States or Canadian Postal Code and a US State or Canadian Province Code, then this should be the required choice.				

Tag Name	Schema Use	Description	Recommended Use	Format
StateProvinceCode	Required	Code for US states, etc., and Canadian provinces.	Required	minOcc 1 maxOcc 1 Enumerations: See Appendix A
PostalCode	Required	The postal code portion of the Address.	Required	minOcc 1 maxOcc 1 minLength 1 maxLength 17
<i>InternationalAddressDetailsGroup</i>	Required choice	This Address Group is for items specific for International Addresses	Required for international addresses	minOcc 1 maxOcc 1
Comment: [InternationalAddressDetailsGroup] does not appear in the instance document. This choice is for addresses that do not have a US or Canadian postal code.				
StateProvince	Optional	The literal name of the state, province or territory of a postal address of the source of this document. Use for addresses outside US or Canada.	Recommended Refer to common postal practices of the source country	minOcc 0 maxOcc 1 minLength 2 maxLength 30
Comment: For an internet resource of states or other geographical subdivisions in countries other than the US and Canada, you might choose to refer to the website of the Universal Postal Union at http://www.upu.int				
PostalCode	Optional	The postal code portion of the Address.	Recommended Refer to common postal practices of the source country	minOcc 0 maxOcc 1 minLength 1 maxLength 17
Comment: For an internet resource of states or other geographical subdivisions in countries other than the US and Canada, you might choose to refer to the website of the Universal Postal Union at http://www.upu.int				
CountryCode	Required	Code indicating Country. Use ISO 3166-1 alpha-2 standard.	Required	minOcc 1 maxOcc 1 Enumerations: See Appendix B
AttentionLine	Optional	The individual or office name within the postal address where inquiries should be directed.	Optional	minOcc 1 maxOcc ∞ minLength 1 maxLength 45
Comment: This might be used to indicate where questions about the record should be sent. For example, <i>Principal, Guidance Counselor, Headmaster, etc.</i>				
NoteMessage	Optional Repeatable	Additional information about the addresses of the contacts at the source school	Not recommended	minOcc 0 maxOcc ∞ minLength 1 maxLength 80

TransmissionData.Source.Organization.Contacts.Address (Continued)

Code illustration 1 (Domestic Address):

```
<Address>
  <AddressLine>1715 W Cesar Chavez</AddressLine>
  <City>Austin</City>
  <StateProvinceCode>TX</StateProvinceCode>
  <PostalCode>78703</PostalCode>
  <AttentionLine>Jane Doe</AttentionLine>
    <AttentionLine>GuidanceCounselor</AttentionLine>
  <NoteMessage />
</Address>
```

Code illustration 2 (International Address):

```
<Address>
  <AddressLine>Altova Corporation</AddressLine>
  <AddressLine>Rudolfsplatz 13a/9</AddressLine>
  <City>Wien</City>
  <StateProvince/>
  <PostalCode>A-1010</PostalCode>
  <CountryCode>AT</CountryCode>
</Address>
```

TransmissionData.Source.Organization.Contacts.Phone

Note: Although the complex data element Phone is an optional data element, if you choose to send the Phone of a Contact at the Sending Institution, then you must send a phone number.

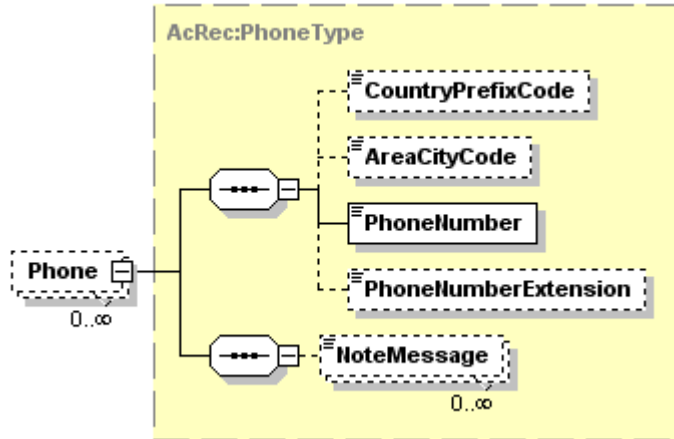

Tag Name	Schema Use	Description	Recommended Use	Format
CountryPrefixCode	Optional	International dialing code	Recommended	minOcc 0 maxOcc 1 minLength 1 maxLength 3
AreaCityCode	Optional	Regional dialing code	Recommended	minOcc 0 maxOcc 1 minLength 1 maxLength 5
PhoneNumber	Required	Telephone number	Required	minOcc 1 maxOcc 1 minLength 1 maxLength 11
Comment: The phone number will typically be sent as a string of numbers with no spaces, periods or dashes.				
PhoneNumberExtension	Optional	The extended telephone addressing information used in addition to phone number such as a PBX extension, a pager PIN, or FAX sub-address	Optional	minOcc 0 maxOcc 1 minLength 1 maxLength 5
NoteMessage	Optional Repeatable	Additional information about the phone number of the contact at the source institution	Not recommended	minOcc 0 maxOcc ∞ minLength 1 maxLength 80

Code illustration:

```

<Phone>
  <CountryPrefixCode/>
  <AreaCityCode>512</AreaCityCode>
  <PhoneNumber>4142505</PhoneNumber>
  <PhoneNumberExtension />
</Phone>

  <Phone>
  <CountryPrefixCode/>
  <AreaCityCode>512</AreaCityCode>
  <PhoneNumber>4747935</PhoneNumber>
  <PhoneNumberExtension/>
  <NoteMessage>Fax</NoteMessage>
</Phone>
    
```

TransmissionData.Source.Organization.Contacts.Email

Note: Although the complex data element Email is an optional data element, if you choose to send the Email of a Contact at the Sending Institution, then you must send the data element EmailAddress.

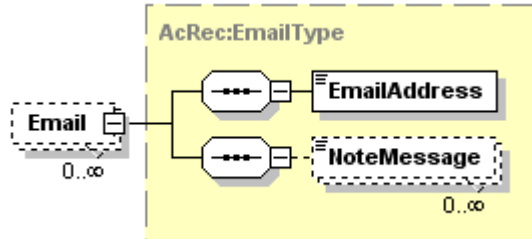

Tag Name	Schema Use	Description	Recommended Use	Format
EmailAddress	Required	The numbers, letters, and symbols used to identify an electronic mail (Email) user within a network.	Required	minOcc 1 maxOc 1 minLength 1 maxLength 128
NoteMessage	Optional Repeatable	Additional information about the email address of the contact at the sending high school	Not recommended	minOcc 0 maxOc ∞ minLength 1 maxLength 80

Code illustration:

```
<Email>
  <EmailAddress>registrar@anyhighschool.edu</EmailAddress>
  <NoteMessage />
</Email>
```

TransmissionData.Source.Organization.Contacts.URL

Note: Although the complex data element URL is an optional data element, if you choose to send the URL of the Sending Institution, then you must send the URLAddress.

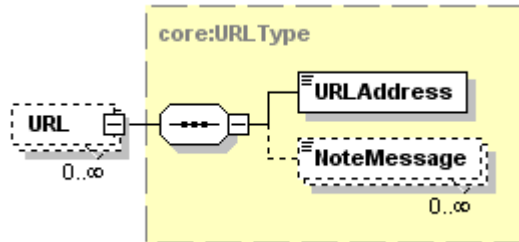

Tag Name	Schema Use	Description	Recommended Use	Format
URLAddress	Required	The Uniform Resource Locator (URL) address of the sending high school or of a contact at the sending high school	Required	minOcc 1 maxOcc 1 minLength 1 maxLength 512
NoteMessage	Optional Repeatable	Additional information about the URL address of the source institution	Not recommended	minOcc 0 maxOcc ∞ minLength 1 maxLength 80

Code illustration:

```
<URL>
  <URLAddress>www.anyhighschool.edu</URLAddress>
  <NoteMessage />
</URL>
```

TransmissionData.Destination

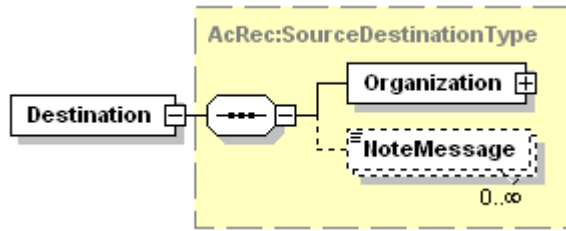

Tag Name	Schema Use	Description	Recommended Use	Format
Organization	Required	Non-person entity such as Organization, Institution, Agency or Business.	Required	minOcc 1 maxOcc 1
Comment: This complex data element will be expanded on page XXX which follows.				
NoteMessage	Optional Repeatable	Additional information about destination organization or school.	Not Recommended	minOcc 0 maxOcc ∞ minLength 1 maxLength 80
Comment: This is the postsecondary school or other agency to which this student's transcript is being sent.				

Code illustration:

```

<Destination>
  <Organization>

  </Organization>
  <NoteMessage />
</Destination>
    
```

TransmissionData.Destination.Organization

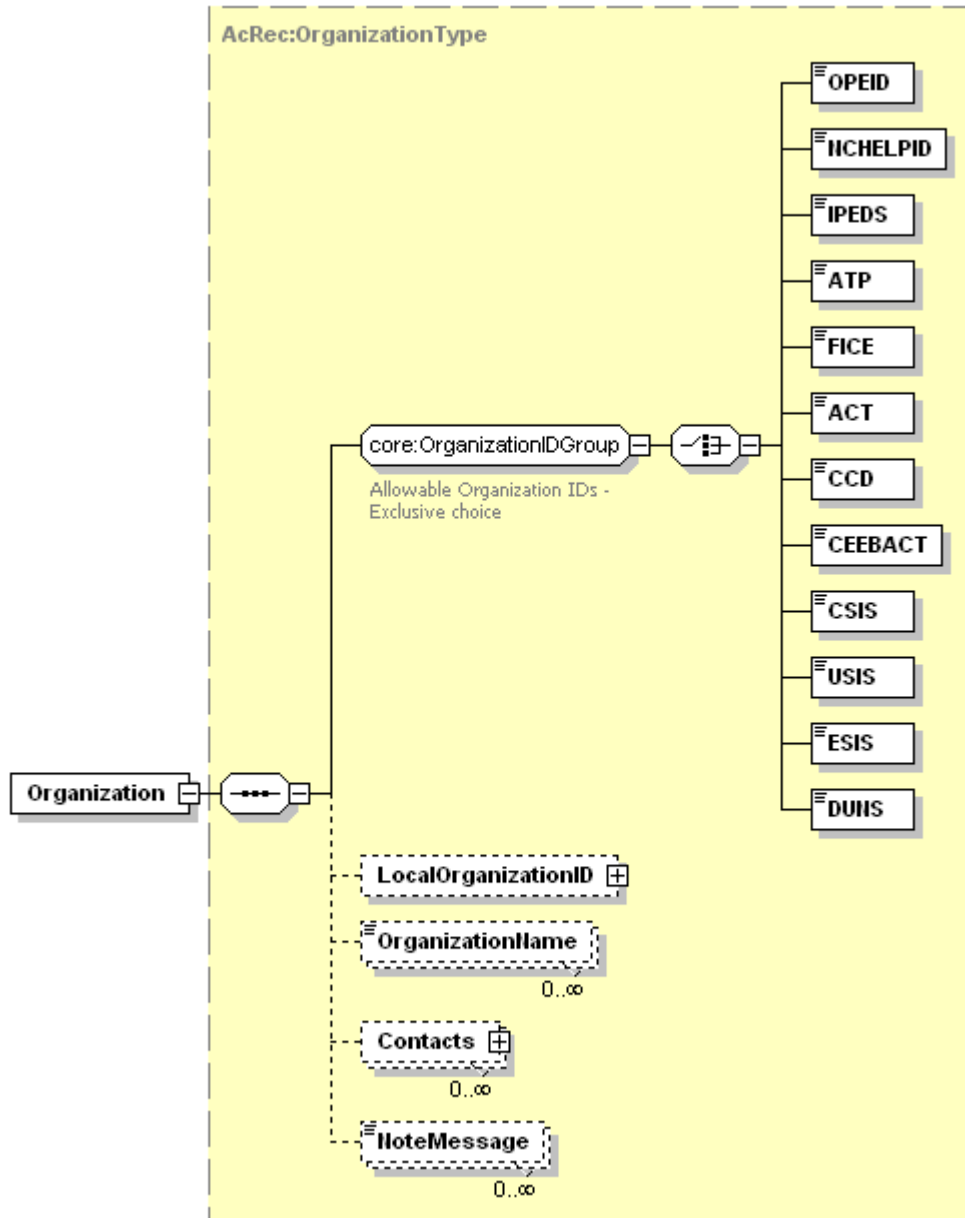

Tag Name	Schema Use	Description	Recommended Use	Format
[OrganizationIDGroup]	Required	Allowable Organization IDs - Exclusive choice	Required	minOcc 1 maxOcc 1
Comment: [OrganizationIDGroup] is not a tag and does not appear in the instance document. It requires the choice of one and only one of the following code set tags to identify the institution/organization.				
OPEID	Required choice	The unique identifier assigned by the Office of Postsecondary Education for each data exchange partner.	Required choice Recommended	minOcc 0 maxOcc 1 minLength 3 maxLength 8
Comment: The OPEID would be an appropriate choice if this high school transcript is being sent to a postsecondary institution and the OPEID is known.				

Tag Name	Schema Use	Description	Recommended Use	Format
NCHELPID	Required choice	The unique identifier assigned by National Council on Higher Education Loan Programs for each data exchange partner.	Not Recommended	minOcc 0 maxOcc 1 minLength 3 maxLength 8
Comment: The NCHELPID would not be an appropriate choice in this case since high school transcripts are not normally sent to the financial aid world.				
IPEDS	Required choice	The unique identifier for Integrated Postsecondary Education Data System assigned by the National Center for Education Statistics for postsecondary data exchange partners	Required choice Recommended	minOcc 0 maxOcc 1 minLength 6 maxLength 6
Comment: The IPEDS would be an appropriate choice if this high school transcript is being sent to a postsecondary institution and the IPEDS number for that institution is known.				
ATP	Required choice	The unique identifier for the Admissions Testing Program assigned by the College Board for each data exchange partner.	Required choice Recommended	minOcc 0 maxOcc 1 minLength 6 maxLength 6
Comment: The ATP would be an appropriate choice if this high school transcript is being sent to a postsecondary institution and the ATP number for that institution is known.				
FICE	Required choice	The unique identifier once maintained for the Federal Interagency Committee on Education by the National Center for Education Statistics for each postsecondary data exchange partner.	Required choice Recommended	minOcc 0 maxOcc 1 minLength 6 maxLength 6
Comment: Although the FICE code set is still widely used by many postsecondary institutions, it has not been maintained by NCES or anyone else since late in the last century. Therefore, codes for new institutions created since then, have been locally assigned and cannot be relied upon. However, if you do know the actual FICE code for the postsecondary institution to which this high school transcript is being sent, this is a recommended choice.				
ACT	Required choice	The unique identifier for postsecondary educational institutions assigned by American College Testing available at www.act.org	Required choice Recommended	minOcc 0 maxOcc 1 minLength 4 maxLength 4
Comment: The ACT would be an appropriate choice if this high school transcript is being sent to a postsecondary institution and the ACT number for that institution is known.				
CCD	Required choice	The unique identifier assigned by the United States Department of Education's National Center for Education Statistics as the Common Core of Data for each data exchange partner.	Not Recommended	minOcc 0 maxOcc 1 minLength 12 maxLength 12
Comment: The CCD was primarily a code set used by K12 and would not be a option for this choice as a destination postsecondary school or agency.				
CEEBACT	Required choice	The unique identifier assigned by the College Entrance Examining Board and ACT for each K-12 data exchange partner.	Not Recommended	minOcc 0 maxOcc 1 minLength 6 maxLength 6
Comment: The CEEBACT code set primarily includes K12 institutions and would not be an option for this choice as a destination postsecondary school or agency.				

Tag Name	Schema Use	Description	Recommended Use	Format
CSIS	Required choice	The unique identifier assigned by the Statistics Canada Canadian College Student Information System for each postsecondary data exchange partner.	Required choice Recommended	minOcc 0 maxOcc 1 minLength 6 maxLength 6
Comment: The CSIS would be an appropriate choice if this high school transcript is being sent to a postsecondary institution in Canada and the CSIS number for that school is known.				
USIS	Required choice	The unique identifier assigned by the Statistics Canada University Student Information System for each data postsecondary exchange partner.	Required choice Recommended	minOcc 0 maxOcc 1 minLength 6 maxLength 6
Comment: The USIS would be an appropriate choice if this high school transcript is being sent to a postsecondary institution in Canada.				
ESIS	Required choice	The unique identifier assigned by the Statistics Canada Enhanced Student Information System for each data postsecondary exchange partner.	Required choice Recommended	minOcc 0 maxOcc 1 minLength 8 maxLength 8
Comment: The ESIS would be an appropriate choice if this high school transcript is being sent to a postsecondary institution in Canada.				
DUNS	Required choice	Data Universal Numbering System (DUNS), unique nine character company identification number issued by Dun and Bradstreet Corporation.	Not Recommended	minOcc 0 maxOcc 1 minLength 9 maxLength 9
Comment: The DUNS number would not be a normal choice to identify the recipient postsecondary institution for a High School Transcript. However, it could be used if this electronic high school transcript is being sent to a company or agency that can receive XML transcripts and that company or agency has a DUNS number that is known to the sending high school.				
Comment: End of OrganizationIDGroup choice set tags				
LocalOrganizationID	Optional	An identification number typically used by a state, province or region to further identify the receiving school or agency	Optional	minOcc 0 maxOcc 1
Comment: This complex data element will be expanded on page XXX which follows.				
OrganizationName	Optional Repeatable	Name of Non-person entity such as Organization, Institution, Agency or Business.	Recommended	minOcc 0 maxOcc ∞ minLength 1 maxLength 60
Comment: You may use repeated OrganizationName to include alternate routing destination (e.g.Human Resources, Graduate School) or you may include this information the Contacts data element which follows.				
Contacts	Optional Repeatable	To identify a person or an office at the receiving school or agency to which administrative communications should be directed	Optional	minOcc 0 maxOcc ∞
Comment: Use Contacts for additional routing instructions and information for the receiving school or agency. This complex data element will be expanded on page XXX which follows.				
NoteMessage	Optional Repeatable	Additional information about the organization	Not recommended	minOcc 0 maxOcc ∞ minLength 1 maxLength 80

TransmissionData.Destination.Organization (Continued)

Code illustration:

```
<Organization>  
  <ATP>006882</ATP>  
  <LocalOrganizationID>  
  
    </LocalOrganizationID>  
    <OrganizationName>THE UNIVERSITY OF TEXAS AT AUSTIN</OrganizationName>  
    <Contacts>  
  
      </Contacts>  
    <NoteMessage />  
</Organization>
```

TransmissionData.Destination.Organization.LocalOrganizationID

Note: Although the complex data element LocalOrganizationID is an optional data element, if you choose to send LocalOrganizationID, then you must also send both LocalOrganizationIDCode and also LocalOrganizationIDQualifier.

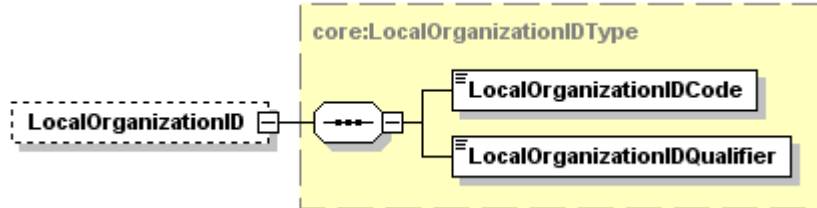

Tag Name	Schema Use	Description	Recommended Use	Format
LocalOrganizationIDCode	Required	The code assigned for the receiving school by the state, province or other mutually defined agency specified in the LocalIDQualifier that follows.	Required	minOcc 1 maxOcc 1 minLength 1 maxLength 35
Comment: This is a required data element only if the Local Organization ID complex data element is sent. This is typically the administrative school code assigned by a state or province to specifically identify the receiving school in that state. If it is not assigned by a state or province, then code ZZ should be used in the Local ID Qualifier that follows.				
LocalIDQualifier	Required	This is the state, province or other mutually defined agency that assigned the Local D Code above.	Required	minOcc 1 maxOcc 1 Enumerations: Sec Appendix A
Comment: This is a required data element only if the Local Organization ID complex data element is sent. This is typically the state or province that assigned the code to specifically identify the receiving school in that state. If it is not assigned by a state or province, then code ZZ should be used in this data element				

Code illustration:

```
<LocalOrganizationID>
  <LocalOrganizationIDCode>012587</LocalOrganizationIDCode>
  <LocalOrganizationIDQualifier>TX</LocalOrganizationIDQualifier>
</LocalOrganizationID>
```

TransmissionData.Destination.Organization.Contacts

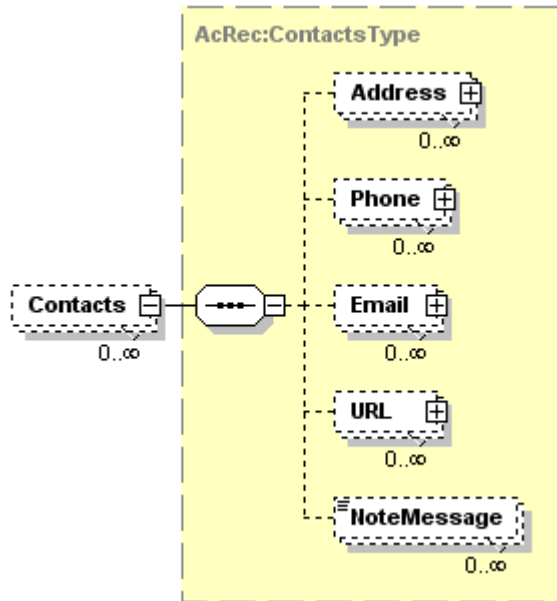

Tag Name	Schema Use	Description	Recommended Use	Format
Address	Optional Repeatable	This is a combined Address Group for a choice between Domestic or International	Optional	minOcc 0 maxOcc ∞
Comment: This address of the recipient postsecondary school or agency is not often used, but it may be helpful to identify the specific recipient of the document. This complex data element will be expanded on page XXX which follows.				
Phone	Optional Repeatable	This is the phone number of the contact at the destination school or agency.	Optional	minOcc 0 maxOcc ∞
Comment: The phone number at the recipient postsecondary school or agency is not often used, but it may be helpful to identify the specific recipient of the document. This complex data element will be expanded on page XXX which follows.				
Email	Optional Repeatable	This is the email address of the contact at the destination school or agency.	Optional	minOcc 0 maxOcc ∞
Comment: The email address at the recipient postsecondary school or agency is not often used, but it may be helpful to identify the specific recipient of the document. This complex data element will be expanded on page XXX which follows.				
URL	Optional Repeatable	This is the Uniform Resource Locator of the destination school or agency.	Not Recommended	minOcc 0 maxOcc ∞
Comment: The URL at the recipient postsecondary school or agency is not often used. This complex data element will be expanded on page XXX which follows.				
NoteMessage	Optional Repeatable	Additional information about the contact at the destination school or agency	Not Recommended	minOcc 0 maxOcc ∞ minLength 1 maxLength 80

TransmissionData.Destination.Organization.Contacts (Continued)

Code illustration:

```
<Contacts>
  <Address>

    </Address>
    <Phone>

      </Phone>
      <Email>

        </Email>
        <URL>

          </URL>
          <NoteMessage />
</Contacts>
```

TransmissionData.Destination.Organization.Contacts.Address

Note: Although the complex data element Address is an optional data element, if you choose to send the Address of Contacts at the Destination Institution or Agency, then you must send AddressLine and City and also StateProvinceCode, and PostalCode OR CountryCode.

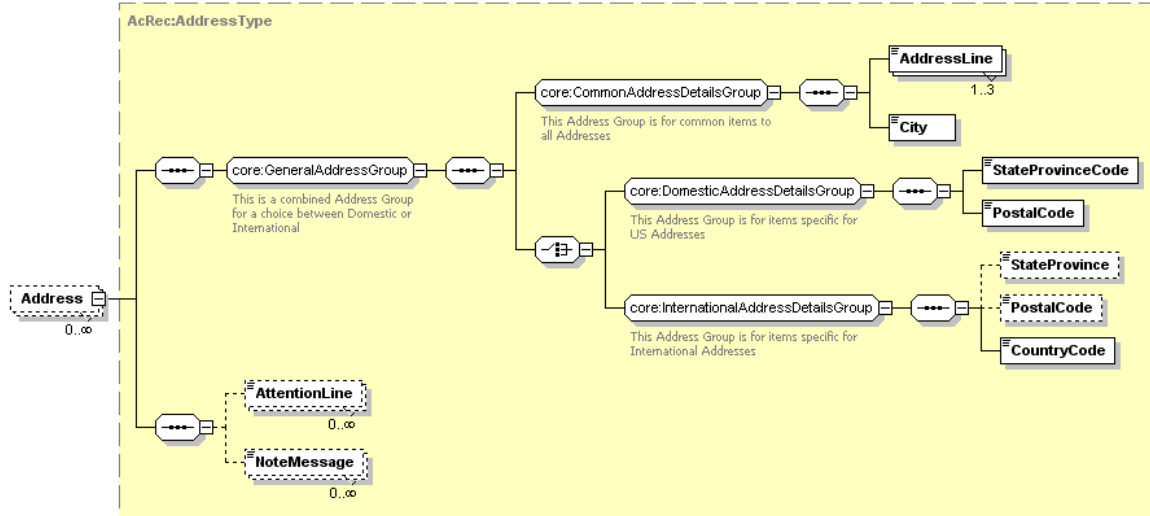

Tag Name	Schema Use	Description	Recommended Use	Format
<i>GeneralAddressGroup</i>	Required	This Address Group is for items common to all Addresses	Required	minOcc 1 maxOcc 1
Comment: [<i>GeneralAddressGroup</i>] does not appear in the instance document. It requires the use of <i>CommonAddressDetailsGroup</i> and the choice of one of either <i>DomesticAddressDetailsGroup</i> or <i>InternationalAddressDetailsGroup</i> . This group is required in the schema only if you choose to send the address of the contact or school.				
<i>CommonAddressDetailsGroup</i>	Required	This Address Group is for items common to all Addresses	Required	minOcc 1 maxOcc 1
Comment: [<i>CommonAddressDetailsGroup</i>] does not appear in the instance document. If the address of a contact is included in the transcript, then this must be sent. It is required and must be paired with one of either <i>DomesticAddressDetailsGroup</i> or <i>InternationalAddressDetailsGroup</i> .				
<i>AddressLine</i>	Required Repeatable	Local delivery information such as street, building number, PO box, or apartment portion of a postal address of a Contact at the Receiving (Destination) High School.	Required	minOcc 1 maxOcc 3 minLength 1 maxLength 40
<i>City</i>	Required	The city portion of the Address of a Contact at the Receiving (Destination) High School.	Required	minOcc 1 maxOcc 1 minLength 2 maxLength 30
<i>DomesticAddressDetailsGroup</i>	Required choice	This Address Group is for items specific for US and Canadian Addresses	Required for domestic addresses	minOcc 1 maxOcc 1
Comment: [<i>DomesticAddressDetailsGroup</i>] does not appear in the instance document. If the complex data element address has a United States or Canadian Postal Code and a US State or Canadian Province Code, then this should be the required choice.				

Tag Name	Schema Use	Description	Recommended Use	Format
StateProvinceCode	Required	Code for US states, etc. and Canadian provinces.	Required	minOcc 1 maxOcc 1 Enumerations: See Appendix A
PostalCode	Required	The postal code portion of the Address.	Required	minOcc 1 maxOcc 1 minLength 1 maxLength 17
<i>InternationalAddressDetailsGroup</i>	Required choice	This Address Group is for items specific for International Addresses	Required for international addresses	minOcc 1 maxOcc 1
Comment: [InternationalAddressDetailsGroup] does not appear in the instance document. This choice is for addresses that do not have a US or Canadian postal code.				
StateProvince	Optional	The literal name of the state, province or territory of a postal address of the source of this document. Use for addresses outside US or Canada.	Recommended Refer to common postal practices of the destination country	minOcc 0 maxOcc 1 minLength 2 maxLength 30
Comment: For an internet resource of states or other geographical subdivisions in countries other than the US and Canada, you might choose to refer to the website of the Universal Postal Union at http://www.upu.int				
PostalCode	Optional	The postal code portion of the Address.	Recommended Refer to common postal practices of the destination country	minOcc 0 maxOcc 1 minLength 1 maxLength 17
Comment: For an internet resource of states or other geographical subdivisions in countries other than the US and Canada, you might choose to refer to the website of the Universal Postal Union at http://www.upu.int				
CountryCode	Required	Code indicating Country. Use ISO 3166-1 alpha-2 standard.	Required	minOcc 1 maxOcc 1 Enumerations: See Appendix B
AttentionLine	Optional Repeatable	The individual or office name within the postal address where inquiries should be directed.	Optional	minOcc 0 maxOcc ∞ minLength 1 maxLength 45
NoteMessage	Optional Repeatable	Additional information about the addresses of the contacts at the destination school	Not recommended	minOcc 0 maxOcc ∞ minLength 1 maxLength 80

TransmissionData.Destination.Organization.Contacts.Address (Continued)

Code illustration 1 (Domestic Address):

```
<Address>
  <AddressLine>1715 W Cesar Chavez</AddressLine>
  <City>Austin</City>
  <StateProvinceCode>TX</StateProvinceCode>
  <PostalCode>78703</PostalCode>
  <AttentionLine>Jane Doe</AttentionLine>
    <AttentionLine>Guidance Counselor</AttentionLine>
  <NoteMessage />
</Address>
```

Code illustration 2 (International Address):

```
<Address>
  <AddressLine>Altova Corporation</AddressLine>
  <AddressLine>Rudolfsplatz 13a/9</AddressLine>
  <City>Wien</City>
  <StateProvince/>
  <PostalCode>A-1010</PostalCode>
  <CountryCode>AT</CountryCode>
</Address>
```

TransmissionData.Destination.Organization.Contacts.Phone

Note: Although the complex data element Phone is an optional data element, if you choose to send the Phone of a Contact at the Receiving Institution, then you must send a phone number.

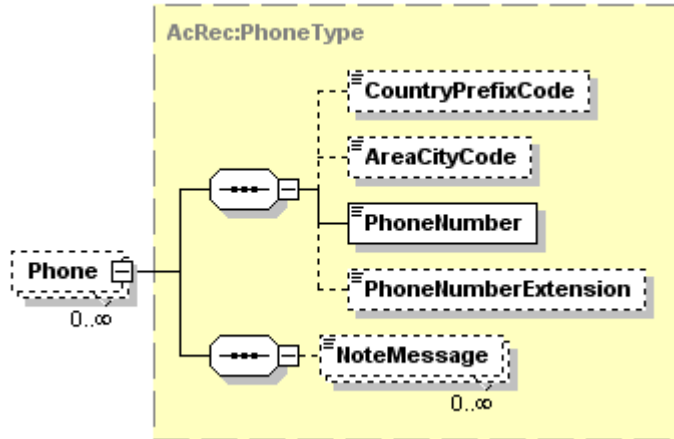

Tag Name	Schema Use	Description	Recommended Use	Format
CountryPrefixCode	Optional	International dialing code	Optional	minOcc 0 maxOcc 1 minLength 1 maxLength 3
AreaCityCode	Optional	Regional dialing code	Recommended	minOcc 0 maxOcc 1 minLength 1 maxLength 5
PhoneNumber	Required	Telephone number	Required	minOcc 1 maxOcc 1 minLength 1 maxLength 11
PhoneNumberExtension	Optional	The extended telephone addressing information used in addition to phone number such as a PBX extension, a pager PIN, or FAX sub-address.	Optional	minOcc 0 maxOcc 1 minLength 1 maxLength 5
NoteMessage	Optional Repeatable	Additional information about the phone number of the contact at the destination school or agency	Not recommended	minOcc 0 maxOcc ∞ minLength 1 maxLength 80

Code illustration:

```

<Phone>
  <CountryPrefixCode />
  <AreaCityCode>512</AreaCityCode>
  <PhoneNumber>4757638</PhoneNumber>
  <PhoneNumberExtension>4589</PhoneNumberExtension>
</Phone>
    
```

TransmissionData.Destination.Organization.Contacts.Email

Note: Although the complex data element Email is an optional data element, if you choose to send the Email of a Contact at the Receiving Institution or Agency, then you must send the data element EmailAddress.

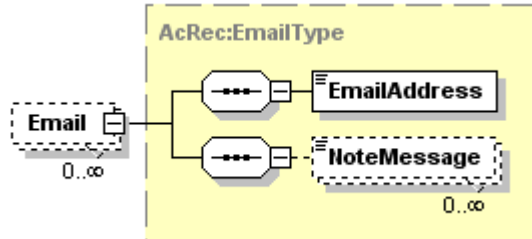

Tag Name	Schema Use	Description	Recommended Use	Format
EmailAddress	Required	The numbers, letters, and symbols used to identify an electronic mail (Email) user within a network.	Required	minOcc 1 maxOcc 1 minLength 1 maxLength 128
NoteMessage	Optional Repeatable	Additional information about the email address of the contact at the destination school or agency	Not recommended	minOcc 0 maxOcc ∞ minLength 1 maxLength 80

Code illustration:

```

<Email>
  <EmailAddress>AdmissionsDirector@UTAustin.edu</EmailAddress>
  <NoteMessage />
</Email>
    
```

TransmissionData.Destination.Organization.Contacts.URL

Note: Although the complex data element URL is an optional data element, if you choose to send the URL of a Contact at the Receiving Institution or Agency, then you must send the URLAddress.

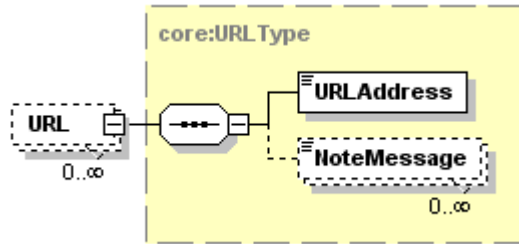

Tag Name	Schema Use	Description	Recommended Use	Format
URLAddress	Required	The Uniform Resource Locator (URL) address associated with a product, deliverable or contact.	Required	minOcc 1 maxOcc 1 minLength 0 maxLength 512
NoteMessage	Optional Repeatable	Additional information about the URL of the contact at the destination school or agency	Not Recommended	minOcc 0 maxOcc ∞ minLength 1 maxLength 80

Code illustration:

```
<URL>
  <URLAddress>www.anyuniversity.edu</URLAddress>
  <NoteMessage />
</URL>
```

Student

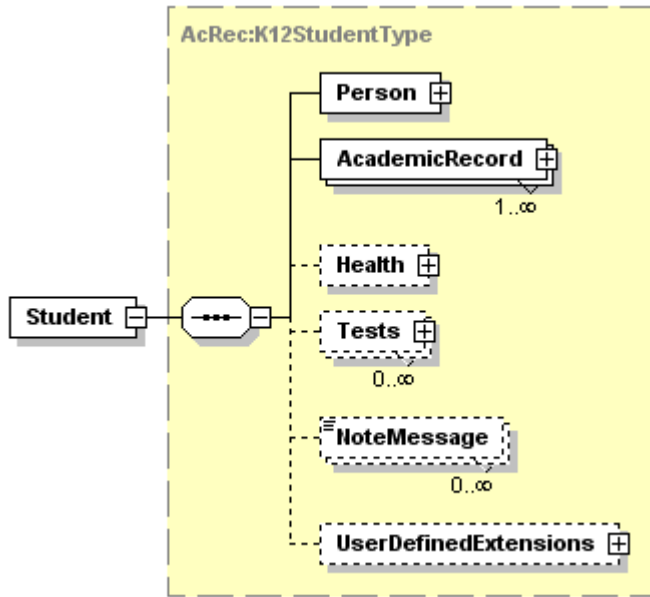

Tag Name	Schema Use	Description	Recommended Use	Format
Person	Required	Biographical and demographic information about the student.	Required	minOcc 1 maxOcc 1
Comment: This complex data element will be expanded on page XXX which follows.				
AcademicRecord	Required Repeatable	Information concerning the academic achievement or status of the student.	Required	minOcc 1 maxOcc ∞
Comment: The AcademicRecord complex data element may be repeated. There must be at least one occurrence which normally represents the record from the sending institution; additional occurrences may be included for transferred work. This complex data element will be expanded on page XXX which follows.				
Health	Optional	Immunization, vaccinations and health screenings	Optional	minOcc 0 maxOcc 1
Comment: This complex data element will be expanded on page XXX which follows.				
Tests	Optional Repeatable	Academic and achievement test data	Optional	minOcc 0 maxOcc ∞
Comment: Tests administered by national testing agencies are recommended to come directly from the agency and should not normally be included with the transcript. Use this section for state and local test data as required. This complex data element will be expanded on page XXX which follows.				
NoteMessage	Optional Repeatable	Additional information about the student	Not Recommended	minOcc 0 maxOcc ∞ minLength 1 maxLength 80
UserDefinedExtensions	Optional	Additional structured information. Requires mutually defined XML schema.	Optional	minOcc 0 maxOcc 1

Student (Continued)

Code illustration:

```
<Student>  
  <Person>  
  
    </Person>  
    <AcademicRecord>  
  
      </AcademicRecord>  
      <Health>  
  
        </Health>  
        <Tests>  
  
          </Tests>  
          <NoteMessage />  
          <UserDefinedExtensions />  
</Student>
```

Student.Person

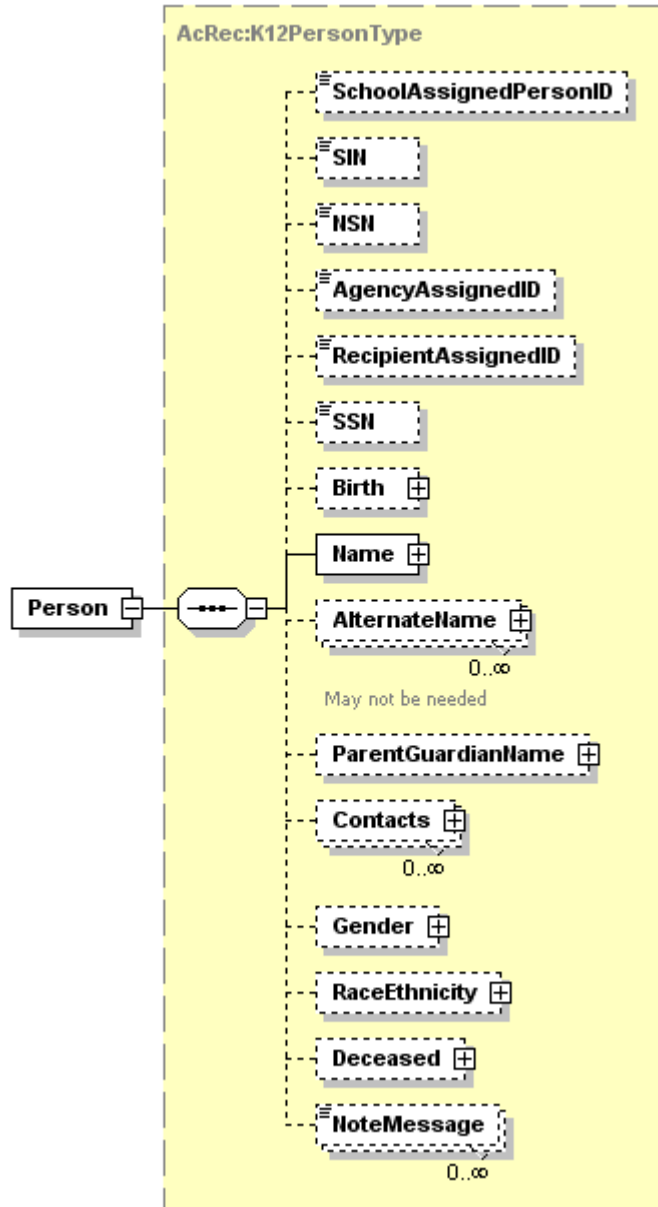

Tag Name	Schema Use	Description	Recommended Use	Format
SchoolAssignedPersonID	Optional	School Assigned Identifier Type	Recommended	minOcc 0 maxOcc 1 minLength 1 maxLength 20

Comment: This is the student's ID at the source or sending school. It is recommended that this ID number be included, even if the student ID number used is an Agency Assigned ID.

Tag Name	Schema Use	Description	Recommended Use	Format
SIN	Optional	The person's Canadian Social Insurance Number	Not Recommended	minOcc 0 maxOcc 1 minLength 9 maxLength 9
Comment: This is a Canadian student's Social Insurance Number assigned by the Canadian government. It is not appropriate for the High School Transcript sent by a US high school. It is not recommended in Canada for use to identify students on education records.				
NSN	Optional	Canadian National Student Identifier Type	Not Recommended	minOcc 0 maxOcc 1 minLength 1 maxLength 30
Comment: This is a postsecondary Canadian student's National Student Number assigned by postsecondary schools using the format used by Statistics Canada. It is not appropriate for the High School Transcript.				
AgencyAssignedID	Optional	The ID assigned by the state or province or an agency, to the person (student).	Optional	minOcc 0 maxOcc 1 minLength 1 maxLength 30
RecipientAssignedID	Optional	RecipientAssigned Identifier Type	Optional	minOcc 0 maxOcc 1 minLength 1 maxLength 20
Comment: If this transcript is being sent in response to a request for the transcript from another institution, then this is the student's ID number at the school that requested the record.				
SSN	Optional	The person's U.S. Social Security Number	Recommended	pattern \d{9} minOcc 0 maxOcc 1
Comment: If included, this number must be sent as a string of nine numbers with no dashes. While the SSN is no longer appropriate for use as a student identifier, it is extremely helpful for the receiving school or agency to match the student's record there.				
Birth	Optional	Identifying information related to a person's birth	Recommended	minOcc 0 maxOcc 1
Comment: This complex data element will be expanded on page XXX which follows. This information is very helpful in matching the transcript with the student's record at the receiving institution. It is almost essential if the SSN is not included.				
Name	Required	The name of record at the sending institution	Required	minOcc 1 maxOcc 1
Comment: This should be the full legal name of the student as recorded at the sending institution. This complex data element will be expanded on page XXX which follows.				
AlternateName	Optional Repeatable	Any other names by which the person may be known	Optional	minOcc 0 maxOcc ∞
Comment: Includes former name(s), nicknames, or other names by which the student may be known. This complex data element will be expanded on page XXX which follows.				
ParentGuardianName	Optional	This is the name of the primary parent or guardian responsible for the high school student.	Optional	minOcc 0 maxOcc 1
Comment: Useful for matching; it does not contain any academic information for the student. This complex data element will be expanded on page XXX which follows.				
Contacts	Optional Repeatable	Contact information for the student as recorded by the sending institution	Recommended	minOcc 0 maxOcc ∞
Comment: This is helpful for creating a record when the receiving institution has not previously been contacted by the student. It may also help to match this transcript with the student's record at the receiving school, especially if the SSN is not included. This complex data element will be expanded on page XXX which follows.				

Tag Name	Schema Use	Description	Recommended Use	Format
Gender	Optional	Gender of the student	Recommended	minOcc 0 maxOcc 1 minLength 9 maxLength 9
Comment: Useful for matching. Although AACRAO does not recommend including this information on the paper transcript, it is recommended to be included on the XML electronic transcript if the destination is to a postsecondary institution or other governmental agency. This complex data element will be expanded on page XXX which follows.				
RaceEthnicity	Optional	The student's race and ethnicity code as recorded in the sending school's records.	Optional	minOcc 0 maxOcc 1
Comment: May be helpful for receiving institution to identify the student. This complex data element will be expanded on page XXX which follows.				
Deceased	Optional	Information related a student's death	Optional	minOcc 0 maxOcc 1
Comment: Recommended if the student is deceased; useful for fraud prevention. This complex data element will be expanded on page XXX which follows.				
NoteMessage	Optional Repeatable	Additional information about the person	Not Recommended	minOcc 0 maxOcc ∞ minLength 1 maxLength 80

Code illustration:

```

<Person>
  <SchoolAssignedPersonID>5555555</SchoolAssignedPersonID>
  <SIN/>
  <NSN/>
  <AgencyAssignedID>FL130123456789</AgencyAssignedID>
  <RecipientAssignedID/>
  <SSN>555555555</SSN>
  <Birth>

  </Birth>
  <Name>

  </Name>
  <AlternateName>

  </AlternateName>
  <ParentGuardianName>

  </ParentGuardianName>
  <Contacts>

  </Contacts>
  <Gender>

  </Gender>

  <RaceEthnicity>

  </RaceEthnicity>
  <Deceased>

  </Deceased>
  <NoteMessage />
</Person>
    
```

Student.Person.Birth

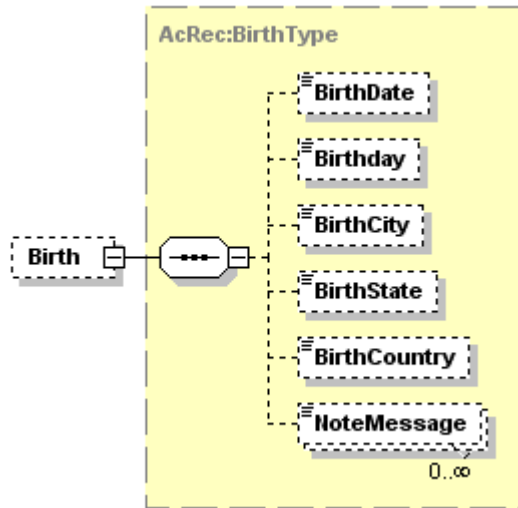

Tag Name	Schema Use	Description	Recommended Use	Format
BirthDate	Optional	Date of Birth	Recommended	minOcc 0 maxOcc 1 xs:date Format is ccyy-mm-dd
Birthday	Optional	Month and Day of Birth	Optional	minOcc 0 maxOcc 1 xs:gMonthDay Format is mm-dd
Comment: Use instead of BirthDate when it is desirable to withhold the student's age.				
BirthCity	Optional	The city in which the person was born.	Optional	minOcc 0 maxOcc 1 minLength 2 maxLength 30
Comment: This may be useful in identifying the student at the receiving institution, especially if the SSN and the Date of Birth are not included.				
BirthState	Optional	The state (within the United States) or extra-state jurisdiction in which the person was born	Optional	minOcc 0 maxOcc 1 Enumerations: See Appendix A
Comment: This may be useful in identifying the student at the receiving institution, especially if the SSN and the Date of Birth are not included.				
BirthCountry	Optional	The name of the country in which the person was born. Use ISO 3 155-1 alpha-2 standard.	Optional	minOcc 0 maxOcc 1 Enumerations: See Appendix B
Comment: This may be useful in identifying the student at the receiving institution, especially if the SSN and the Date of Birth are not included.				
NoteMessage	Optional Repeatable	Additional information about Birth	Not Recommended	minOcc 0 maxOcc ∞ minLength 1 maxLength 80

Student.Person.Birth (Continued)

Code illustration:

```
<Birth>  
  <BirthDate>1987-07-20</BirthDate>  
  <Birthday/>  
  <BirthCity>Miami</BirthCity>  
  <BirthState>FL</BirthState>  
  <BirthCountry>US</BirthCountry>  
  <NoteMessage />  
</Birth>
```

Student.Person.Name

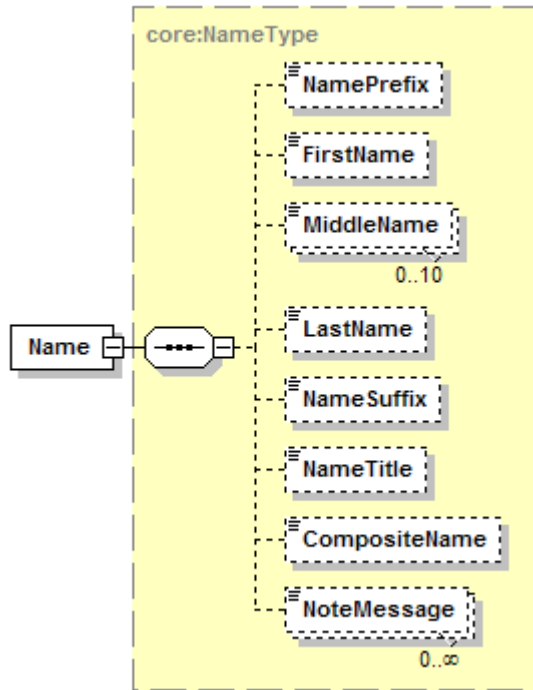

Tag Name	Schema Use	Description	Recommended Use	Format
NamePrefix	Optional	An honorific, title or form of address that precedes the name.	Not Recommended	minOcc 0 maxOcc 1 minLength 1 maxLength 30
FirstName	Optional	The first name of the person, usually given at birth, baptism, or during, another ceremony, or through legal change	Recommended	minOcc 0 maxOcc 1 minLength 1 maxLength 35
MiddleName	Optional Repeatable	A secondary name of the person, usually given at birth, baptism, or during another naming ceremony or through legal change	Recommended	minOcc 0 maxOcc 10 minLength 1 maxLength 35
LastName	Optional	The last name or surname by which a person is legally known	Recommended	minOcc 0 maxOcc 1 minLength 1 maxLength 35
NameSuffix	Optional	The expression of an individual's generation within a family.	Recommended	minOcc 0 maxOcc 1 Enumerations: JR SR I II III IV
NameTitle	Optional	An honorific, title or credential that follows the name.	Not Recommended	minOcc 0 maxOcc 1 minLength 1 maxLength 30

Tag Name	Schema Use	Description	Recommended Use	Format
CompositeName	Optional	The full name of the person in Last NameSuffix, First Middle order; comma after last name or NameSuffix	Not Recommended	minOcc 0 maxOcc 1 minLength 1 maxLength 45
<p>Comment: The use of the Composite Name, while it is allowed, is not recommended. It is felt that the storing of a person's name in schools' student information systems as individual components is becoming more common. And it should be easier for the sending school to break up a composite name into its individual components, than for the receiving school to do so.</p>				
NoteMessage	Optional Repeatable	Additional information about the student name	Not Recommended	minOcc 0 maxOcc ∞ minLength 1 maxLength 80

Code illustration:

```

<Name>
  <NamePrefix />
  <FirstName>John</FirstName>
  <MiddleName>Billy</MiddleName>
  <MiddleName>Bob</MiddleName>
  <LastName>Thornton</LastName>
  <NameSuffix>JR</NameSuffix>
  <NameTitle />
  <CompositeName />
  <NoteMessage />
</Name>
    
```

Student.Person.AlternateName

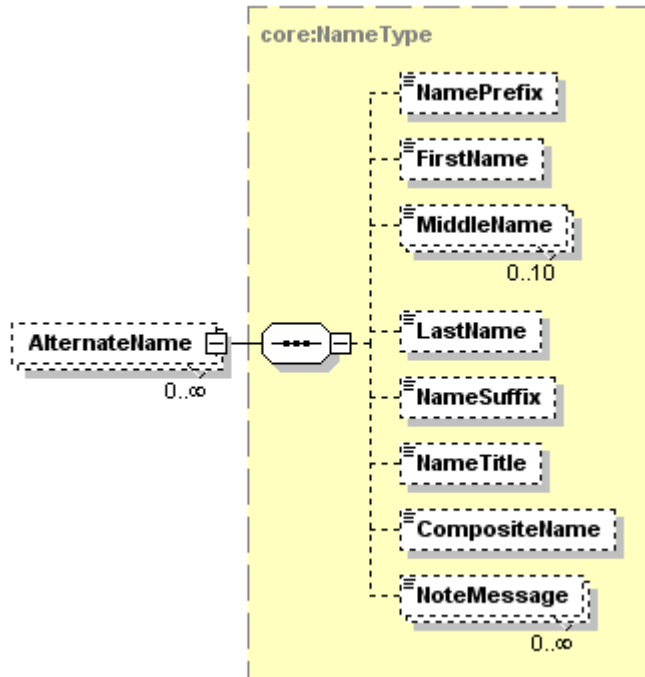

Tag Name	Schema Use	Description	Recommended Use	Format
NamePrefix	Optional	An honorific, title or form of address that precedes the name.	Not Recommended	minOcc 0 maxOcc 1 minLength 1 maxLength 30
FirstName	Optional	The first name of the person, usually given at birth, baptism, or during another ceremony, or through legal change	Recommended	minOcc 0 maxOcc 1 minLength 1 maxLength 35
MiddleName	Optional Repeatable	A secondary name of the person, usually given at birth, baptism, or during another naming ceremony or through legal change	Recommended	minOcc 0 maxOcc 10 minLength 1 maxLength 35
LastName	Optional	The last name or surname by which a person is legally known	Recommended	minOcc 0 maxOcc 1 minLength 1 maxLength 35
NameSuffix	Optional	The expression of an individual's generation within a family.	Recommended	minOcc 0 maxOcc 1 Enumerations: JR SR I II III IV
NameTitle	Optional	An honorific, title or credential that follows the name.	Not Recommended	minOcc 0 maxOcc 1 minLength 1 maxLength 30

Tag Name	Schema Use	Description	Recommended Use	Format
CompositeName	Optional	The full name of the person in Last, First Middle order, comma after last name	Not Recommended	minOcc 0 maxOcc 1 minLength 1 maxLength 45
<p>Comment: The use of the Composite Name, while it is allowed, is not recommended. It is felt that the storing of a person's name in schools' student information systems as individual components is becoming more common. And it should be easier for the sending school to break up a composite name into its individual components, than for the receiving school to do so.</p>				
NoteMessage	Optional Repeatable	Additional information about the alternate name	Not Recommended	minOcc 0 maxOcc ∞ minLength 1 maxLength 80
<p>Comment: Sending of alternate names may sometimes help in the matching of this transcript with the student's record at the receiving institution.</p>				

Code illustration:

```

<AlternateName>
  <NamePrefix />
  <FirstName>Test</FirstName>
  <MiddleName>Record</MiddleName>
  <MiddleName>Test</MiddleName>
  <LastName>Speede</LastName>
  <NameSuffix />
  <NameTitle />
  <CompositeName />
  <NoteMessage />
</AlternateName>

```

Student.Person.ParentGuardianName

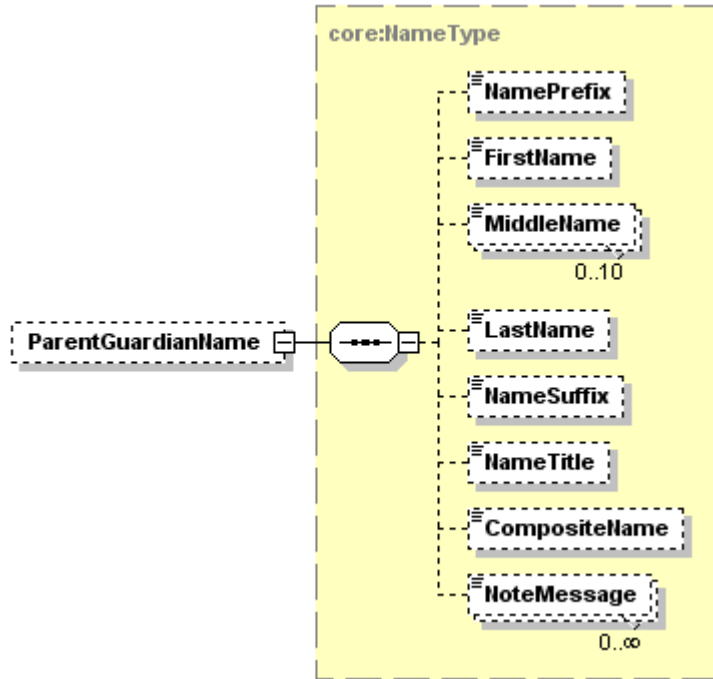

Tag Name	Schema Use	Description	Recommended Use	Format
NamePrefix	Optional	An honorific, title or form of address that precedes the name.	Not Recommended	minOcc 0 maxOcc 1 minLength 1 maxLength 30
FirstName	Optional	The first name of the person, usually given at birth, baptism, or during another ceremony, or through legal change	Recommended	minOcc 0 maxOcc 1 minLength 1 maxLength 35
MiddleName	Optional Repeatable	A secondary Name of the person, usually given at birth, baptism, or during another naming ceremony or through legal change	Recommended	minOcc 0 maxOcc 10 minLength 1 maxLength 35
LastName	Optional	The last name or surname by which a person is legally known	Recommended	minOcc 0 maxOcc 1 minLength 1 maxLength 35
NameSuffix	Optional	The expression of an individual's generation within a family.	Recommended	minOcc 0 maxOcc 1 Enumerations: JR SR I II III IV
NameTitle	Optional	An honorific, title or credential that follows the name.	Not Recommended	minOcc 0 maxOcc 1 minLength 1 maxLength 30

Tag Name	Schema Use	Description	Recommended Use	Format
CompositeName	Optional	The full name of the person in Last, First Middle order, comma after last name	Not Recommended	minOcc 0 maxOcc 1 minLength 1 maxLength 45
<p>Comment: The use of the Composite Name, while it is allowed, is not recommended. It is felt that the storing of a person's name in schools' student information systems as individual components is becoming more common. And it should be easier for the sending school to break up a composite name into its individual components, than for the receiving school to do so.</p>				
NoteMessage	Optional Repeatable	Additional information about the alternate name	Not Recommended	minOcc 0 maxOcc ∞ minLength 1 maxLength 80
<p>Comment: Sending of this information about the responsible parent or guardian may assist in identifying the student and also in contacting the student.</p>				

Code illustration:

```

<ParentGuardianName>
  <NamePrefix />
  <FirstName>Russell</FirstName>
  <MiddleName />
  <LastName>Crowe</LastName>
  <NameSuffix />
  <NameTitle />
  <CompositeName />
  <NoteMessage />
</ParentGuardianName>
    
```

Student.Person.Contacts

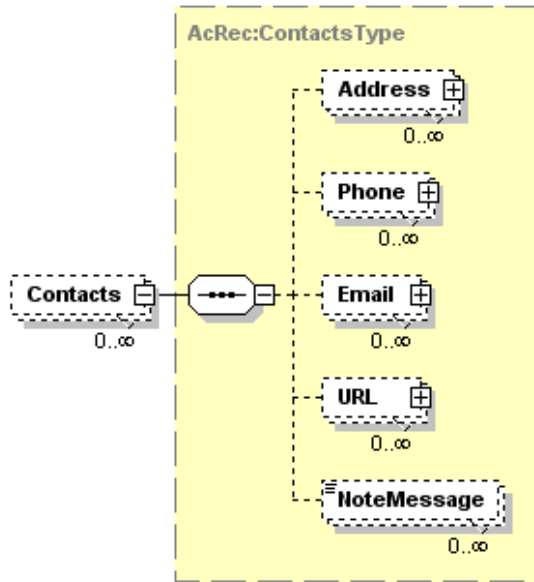

Tag Name	Schema Use	Description	Recommended Use	Format
Address	Optional Repeatable	This is a combined Address Group for a choice between Domestic or International	Recommended	minOcc 0 maxOcc ∞
Comment: This complex data element will be expanded on page XXX which follows.				
Phone	Optional Repeatable	Phone number(s) for the student	Recommended	minOcc 0 maxOcc ∞
Comment: This complex data element will be expanded on page XXX which follows.				
Email	Optional Repeatable	Email address(es) for the student	Recommended	minOcc 0 maxOcc ∞
Comment: This complex data element will be expanded on page XXX which follows.				
URL	Optional Repeatable	Personal URL(s) on record for the student	Not Recommended	minOcc 0 maxOcc ∞
Comment: This complex data element will be expanded on page XXX which follows.				
NoteMessage	Optional Repeatable	Additional information about the Contacts	Not Recommended	minOcc 0 maxOcc ∞ minLength 1 maxLength 80
Comment: The inclusion of the contact information about the student whose transcript is being sent can be helpful at the receiving institution for additional matching criteria. It can also be of use at the receiving school (if the student has not yet applied for admission there) to create a skeletal admissions record if that is the procedure at the receiving school, or it may also be used in an attempt to contact the student to encourage the student to submit an application.				

Student.Person.Contacts (Continued)

Code illustration:

```
<Contacts>
  <Address>

    </Address>
    <Phone>

      </Phone>
      <Email>

        </Email>
        <URL>

          </URL>
          <NoteMessage/>
</Contacts>
```

Student.Person.Contacts.Address

Note: Although the complex data element Address is an optional data element, if you choose to send the Address of the Student, then you must send AddressLine and City and also StateProvinceCode, and PostalCode OR CountryCode.

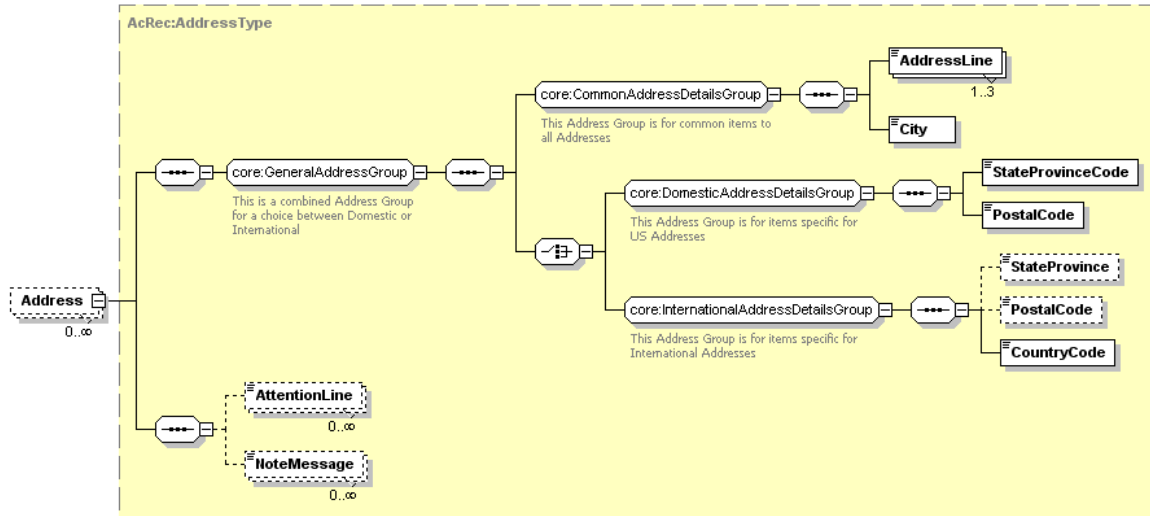

Tag Name	Schema Use	Description	Recommended Use	Format
<i>GeneralAddressGroup</i>	Required	This Address Group is for items common to all Addresses	Required	minOcc 1 maxOcc 1
Comment: [<i>GeneralAddressGroup</i>] does not appear in the instance document. It requires the use of <i>CommonAddressDetailsGroup</i> and the choice of one of either <i>DomesticAddressDetailsGroup</i> or <i>InternationalAddressDetailsGroup</i> . This group is required in the schema only if you choose to send the address of the contact.				
<i>CommonAddressDetailsGroup</i>	Required	This Address Group is for items common to all Addresses	Required	minOcc 1 maxOcc 1
Comment: [<i>CommonAddressDetailsGroup</i>] does not appear in the instance document. If the address of a contact is included in the transcript, then this must be sent. It is required and must be paired with one of either <i>DomesticAddressDetailsGroup</i> or <i>InternationalAddressDetailsGroup</i> .				
<i>AddressLine</i>	Required Repeatable	Local delivery information such as street, building number, PO box, or apartment portion of a postal address of a Contact at the Sending (Source) High School.	Required	minOcc 1 maxOcc 3 minLength 1 maxLength 40
<i>City</i>	Required	The city portion of the Address of a Contact at the Sending (Source) High School.	Required	minOcc 1 maxOcc 1 minLength 2 maxLength 30
<i>DomesticAddressDetailsGroup</i>	Required choice	This Address Group is for items specific for US and Canadian Addresses	Required for domestic addresses	minOcc 1 maxOcc 1
Comment: [<i>DomesticAddressDetailsGroup</i>] does not appear in the instance document. If the complex data element address has a United States or Canadian Postal Code and a US State or Canadian Province Code, then this should be the required choice.				

Tag Name	Schema Use	Description	Recommended Use	Format
StateProvinceCode	Required	Code for US states, etc., and Canadian provinces.	Required	minOcc 1 maxOcc 1 Enumerations: See Appendix A
PostalCode	Required	The postal code portion of the Address.	Required	minOcc 1 maxOcc 1 minLength 1 maxLength 17
<i>InternationalAddressDetailsGroup</i>	Required choice	This Address Group is for items specific for International Addresses	Required for international addresses	minOcc 1 maxOcc 1
Comment: [InternationalAddressDetailsGroup] does not appear in the instance document. This choice is for addresses that do not have a US or Canadian postal code.				
StateProvince	Optional	The literal name of the state, province or territory of a postal address of the source of this document. Use for addresses outside US or Canada.	Recommended Refer to common postal practices of the source country	minOcc 0 maxOcc 1 minLength 2 maxLength 30
Comment: For an internet resource of states or other geographical subdivisions in countries other than the US and Canada, you might choose to refer to the website of the Universal Postal Union at http://www.upu.int				
PostalCode	Optional	The postal code portion of the Address.	Recommended Refer to common postal practices of the source country	minOcc 0 maxOcc 1 minLength 1 maxLength 17
Comment: For an internet resource of states or other geographical subdivisions in countries other than the US and Canada, you might choose to refer to the website of the Universal Postal Union at http://www.upu.int				
CountryCode	Required	Code indicating Country. Use ISO 3166-1 alpha-2 standard.	Required	minOcc 1 maxOcc 1 Enumerations: See Appendix B
AttentionLine	Optional	The individual or office name within the postal address where inquiries should be directed.	Optional	minOcc 1 maxOcc ∞ minLength 1 maxLength 45
NoteMessage	Optional Repeatable	Additional information about the addresses of the contacts at the source school	Not recommended	minOcc 0 maxOcc ∞ minLength 1 maxLength 80

Code illustration 1 (Domestic Address):

```

<Address>
  <AddressLine>1715 W Cesar Chavez</AddressLine>
  <City>Austin</City>
  <StateProvinceCode>TX</StateProvinceCode>
  <PostalCode>78703</PostalCode>
  <AttentionLine>Jane Doe</AttentionLine>
  <AttentionLine>GuidanceCounselor</AttentionLine>
  <NoteMessage />
</Address>
    
```

Student.Person.Contacts.Address (Continued)

Code illustration 2 (International Address):

```
<Address>  
  <AddressLine>Altova Corporation</AddressLine>  
  <AddressLine>Rudolfplatz 13a/9</AddressLine>  
  <City>Wien</City>  
  <StateProvince />  
  <PostalCode>A-1010</PostalCode>  
  <CountryCode>AT</CountryCode>  
</Address>
```

Student.Person.Contacts.Phone

Note: Although the complex data element Phone is an optional data element, if you choose to send the Phone of the Student, then you must send the data element PhoneNumber.

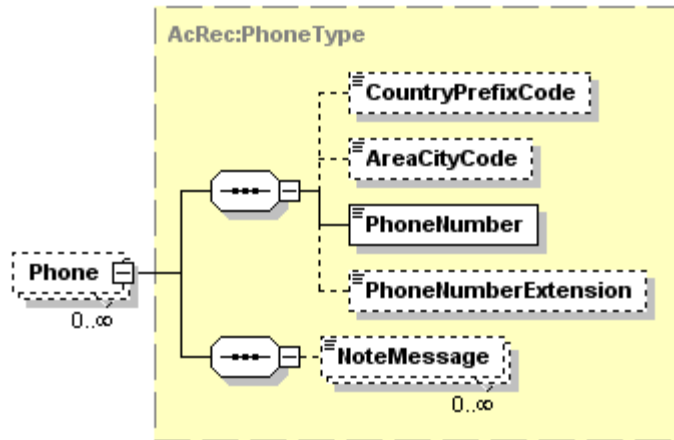

Tag Name	Schema Use	Description	Recommended Use	Format
CountryPrefixCode	Optional	International dialing code.	Optional	minOcc 0 maxOcc 1 minLength 1 maxLength 3
AreaCityCode	Optional	Regional dialing code.	Recommended	minOcc 0 maxOcc 1 minLength 1 maxLength 5
Comment: For phone numbers in the United States and Canada, this is the normal three digit area code.				
PhoneNumber	Required	Telephone number.	Required	minOcc 1 maxOcc 1 minLength 1 maxLength 11
Comment: The phone number is normally sent as a string of 7 numbers with no dashes or periods.				
PhoneNumberExtension	Optional	The extended telephone addressing information used in addition to phone number such as a PBX extension, a pager PIN, or FAX sub-address.	Optional	minOcc 0 maxOcc 1 minLength 1 maxLength 5
NoteMessage	Optional Repeatable	Additional information about the phone number	Not Recommended	minOcc 0 maxOcc ∞ minLength 1 maxLength 80

Code illustration:

```
<Phone>
  <CountryPrefixCode />
  <AreaCityCode>512</AreaCityCode>
  <PhoneNumber>8888888</PhoneNumber>
  <PhoneNumberExtension />
  <NoteMessage />
</Phone>
```

Student.Person.Contacts.Email

Note: Although the complex data element Email is an optional data element, if you choose to send the Email of the Student, then you must send the data element EmailAddress.

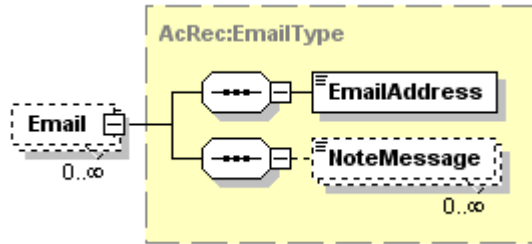

Tag Name	Schema Use	Description	Recommended Use	Format
EmailAddress	Required	The numbers, letters, and symbols used to identify an electronic mail (Email) user within a network.	Required	minOcc 1 maxOcc 1 minLength 1 maxLength 128
NoteMessage	Optional Repeatable	Additional information about the email address	Not recommended	minOcc 0 maxOcc ∞ minLength 1 maxLength 80

Code illustration:

```
<Email>
  <EmailAddress>stewartj@aol.com</EmailAddress>
  <NoteMessage />
</Email>
```

Student.Person.Contacts.URL

Note: Although the complex data element URL is an optional data element, if you choose to send the URL of the Student, then you must send the data element URLAddress.

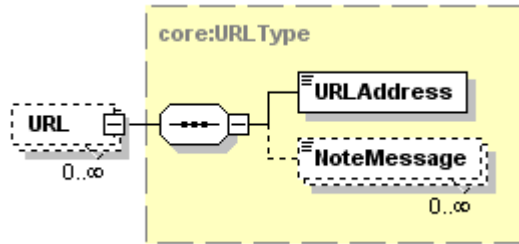

Tag Name	Schema Use	Description	Recommended Use	Format
URLAddress	Required	The Uniform Resource Locator (URL) address associated with a student	Required	minOcc 1 maxOcc 1 minLength 0 maxLength 512
NoteMessage	Optional Repeatable	Additional information about the URL	Not recommended	minOcc 0 maxOcc ∞ minLength 1 maxLength 80

Code illustration:

```
<URL>
  <URLAddress>John.Appleseed.com</URLAddress>
  <NoteMessage />
</URL>
```

Student.Person.Gender

Note: Although the complex data element Gender is an optional data element, if you choose to send the Gender of the Student, then you must send the data element GenderCode.

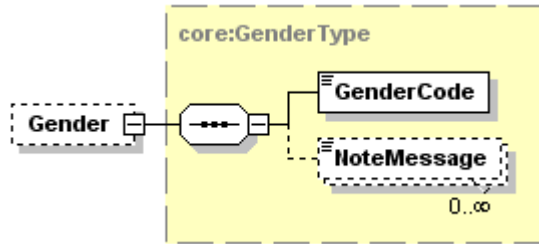

Tag Name	Schema Use	Description	Recommended Use	Format
GenderCode	Required	The gender of the Student	Required	minOcc 1 maxOcc 1 Enumerations: Female Male Unreported
NoteMessage	Optional Repeatable	Additional information about Gender	Not Recommended	minOcc 0 maxOcc ∞ minLength 1 maxLength 80

Code illustration:

```

<Gender>
  <GenderCode>Male</GenderCode>
  <NoteMessage />
</Gender>
    
```

Student.Person.RaceEthnicity

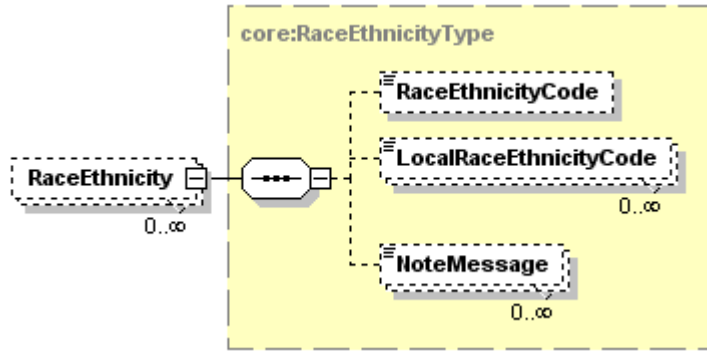

Tag Name	Schema Use	Description	Recommended Use	Format
RaceEthnicityCode	Optional	The student's race and ethnicity code as recorded in the sending school's records.	Optional	minOcc 0 maxOcc 1 Enumerations: AmericanIndianAlaskaNative Asian BlackNonHispanic Hispanic WhiteNonHispanic NativeHawaiianPacificIslander
Comment: Including the Race Ethnicity code may be helpful to the receiving school or agency to identify the student. These are codes recognized by the US Department of Education's National Center for Education Statistics.				
LocalRaceEthnicityCode	Optional Repeatable	The student's race and ethnicity code as defined by the sending school's state, province or region.	Optional	minOcc 0 maxOcc ∞ minLength 1 maxLength 30
NoteMessage	Optional Repeatable	Additional information about the student's race or ethnicity	Not Recommended	minOcc 0 maxOcc ∞ minLength 1 maxLength 80

Code illustration:

```

<RaceEthnicity>
  <RaceEthnicityCode>Hispanic</RaceEthnicityCode>
  <LocalRaceEthnicityCode>Black</LocalRaceEthnicityCode>
  <LocalRaceEthnicityCode>Phillipino</LocalRaceEthnicityCode>
  <NoteMessage />
</RaceEthnicity>
    
```

Student.Person.Deceased

Note: Deceased is an optional complex data element, but if it is included, then the Deceased Indicator must also be included.

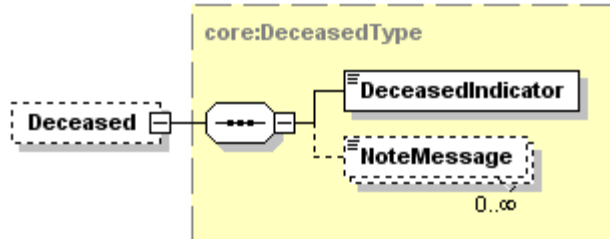

Tag Name	Schema Use	Description	Recommended Use	Format
DeceasedIndicator	Required	Indicates the person is deceased.	Required	minOcc 1 maxOcc 1 true/false
<p>Comment: A value of 'true' indicates the person is reported as deceased in the sending high school's records. If the student is not shown to be deceased, the complex data element "deceased" would not be sent. This indicator would only be sent if the complex data element Deceased is included.</p>				
NoteMessage	Optional Repeatabe	Additional information about the deceased student	Not Recommended	minOcc 0 maxOcc ∞ minLength 1 maxLength 80
<p>Comment: If it is known by the sending institution that the student is deceased, then the inclusion of this indicator can be helpful in preventing the fraudulent use of the transcript by another applicant at the recipient school.</p>				

Code illustration:

```
<Deceased>
  <DeceasedIndicator>true</DeceasedIndicator>
  <NoteMessage>This student died during his senior year in high school.</NoteMessage>
</Deceased>
```

Student.AcademicRecord

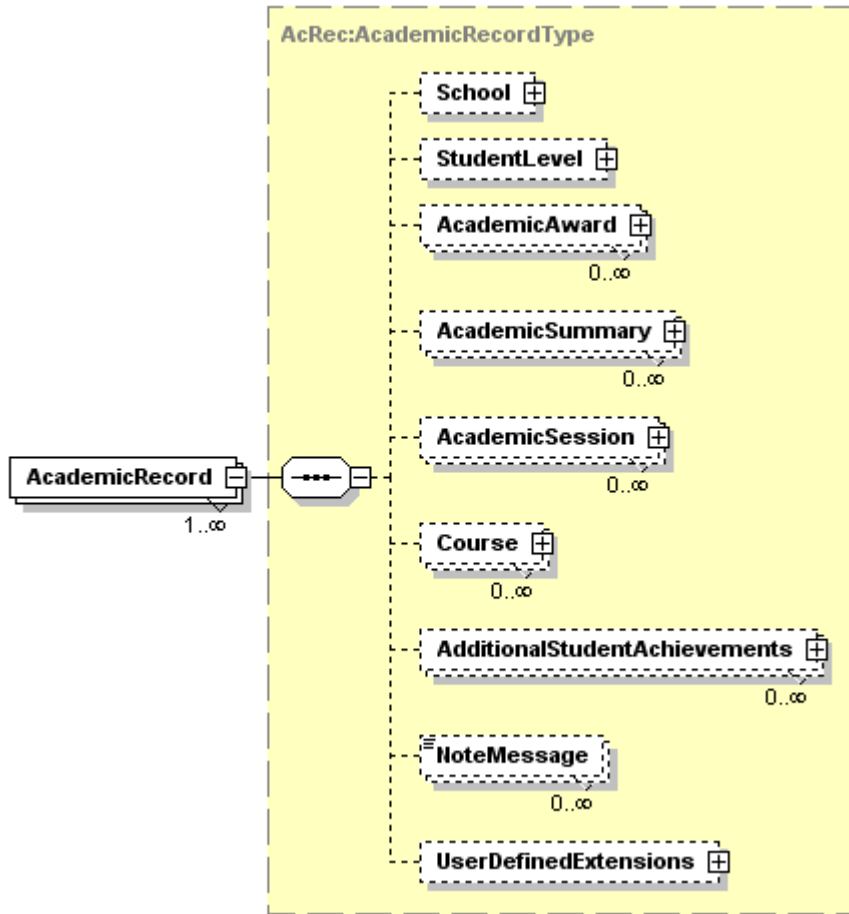

Tag Name	Schema Use	Description	Recommended Use	Format
School	Optional	Override school	Conditional	minOcc 0 maxOcc 1
Comment: Recommended when the school for this repetition of AcademicRecord differs from the Sending institution. Not Recommended when this AcademicRecord belongs to the Sending institution. This complex data element will be expanded on page XXX which follows.				
StudentLevel	Optional	Used to indicate the grade level of the student at the time the transcript is being sent, or the last grade level of the student.	Recommended	minOcc 0 maxOcc 1
Comment: This complex data element will be expanded on page XXX which follows.				
AcademicAward	Optional Repeatable	Academic awards, degrees, diplomas, certifications, etc.	Recommended	minOcc 0 maxOcc ∞
Comment: AcademicAward in this position is not tied to an AcademicSession. Some institutions may instead wish to indicate AcademicAward in the AcademicSession in which it was earned. However, the Workgroup that developed this high school transcript schema recommends that the award of the high school diploma be included at this point in the schema. This complex data element will be expanded on page XXX which follows.				

Tag Name	Schema Use	Description	Recommended Use	Format
AcademicSummary	Optional Repeatable	Used to send summary totals for all work taken at a certain academic level	Recommended	minOcc 0 maxOcc ∞
Comment: <i>AcademicSummary in this position is not tied to an AcademicSession. Some institutions may instead (or also) wish to include AcademicSummary in the AcademicSession in which it was earned. It is also recommended by the Workgroup that developed the PESC XML High School Transcript Schema that this is also the most appropriate place to include the student's rank in class if this information is included on the high school transcript. This complex data element will be expanded on page XXX which follows.</i>				
AcademicSession	Optional Repeatable	Course, award and summary information related to a specific time period. Typically arranged into successive semesters or school years and is the preferred method for conveying academic coursework.	Recommended	minOcc 0 maxOcc ∞
Comment: <i>This complex data element will be expanded on page XXX which follows.</i>				
Course	Optional Repeatable	Academic coursework not related to a specific academic session.	Optional	minOcc 0 maxOcc ∞
Comment: <i>Course in this position is not tied to an AcademicSession. It is appropriate here when session information is not known or when the course is not related to a specific academic session. It is recommended to include coursework within academic session whenever possible. This complex data element will be expanded on page XXX which follows.</i>				
AdditionalStudentAchievements	Optional Repeatable	Achievements not tied to a specific course, session or award.	Optional	minOcc 0 maxOcc ∞
Comment: <i>This complex data element will be expanded on page XXX which follows.</i>				
NoteMessage	Optional Repeatable	Additional information about the student's academic record.	Not Recommended	minOcc 0 maxOcc ∞ minLength 1 maxLength 80
UserDefinedExtensions	Optional	Additional structured information. Requires mutually defined XML schema.	Optional	minOcc 0 maxOcc 1

Code illustration:

```

<AcademicRecord>
  <School>

  </School>
  <StudentLevel>

  </StudentLevel>
  <AcademicAward>

  </AcademicAward>
  <AcademicSummary>

  </AcademicSummary>
  <AcademicSession>

  </AcademicSession>
  <Course>

  </Course>
  <AdditionalStudentAchievements>

  </AdditionalStudentAchievements>
  <NoteMessage />
  <UserDefinedExtensions />
</AcademicRecord>
    
```

Student.AcademicRecord.School

Note: School at this position in the Schema is an optional complex data element, but if it is included, then the Organization Name (Name of this Override School) must be included.

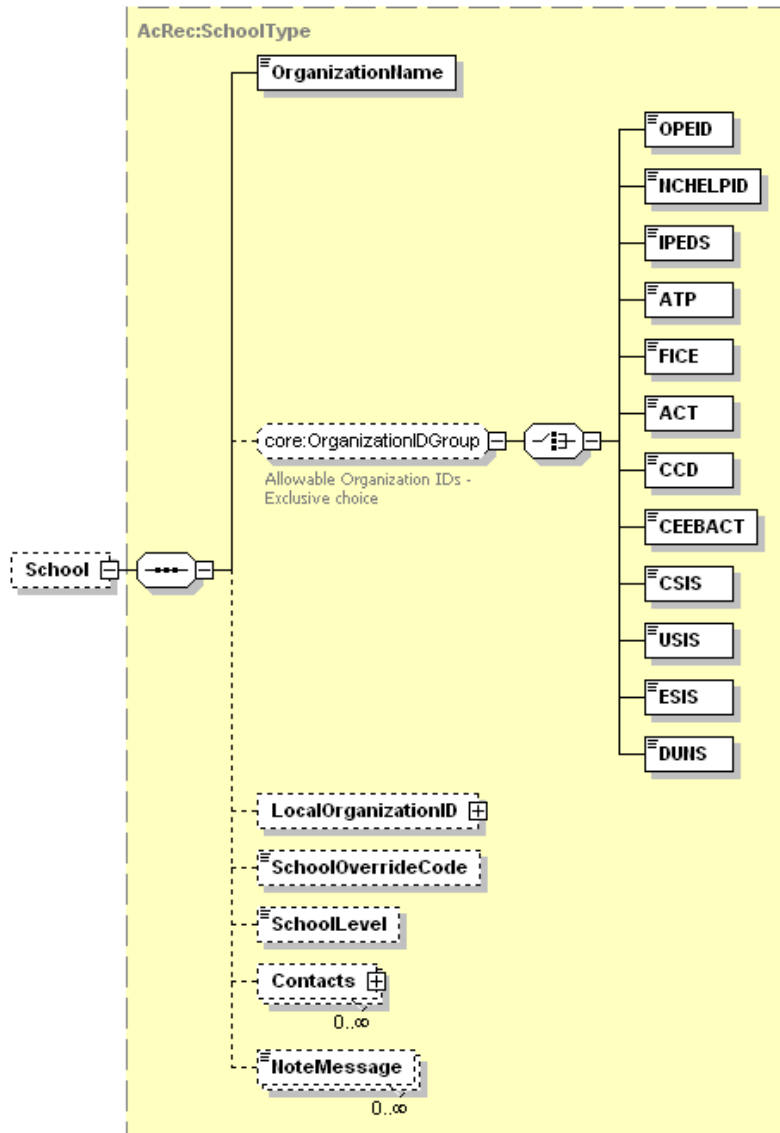

Tag Name	Schema Use	Description	Recommended Use	Format
OrganizationName	Required	Name of Override School.	Required	minOcc 1 maxOcc 1 minLength 1 maxLength 60
<p>Comment: This is the name of the school where the student earned this academic record, if it is different from the school creating the student's record. If this school is the same as the school creating the student's record, this entire portion of data is not needed and should not be sent.</p>				
[OrganizationIDGroup]	Optional	Allowable Organization IDs - Exclusive choice	Recommended	minOcc 0 maxOcc 1
<p>Comment: This is an optional exclusive choice which means that it is not necessary to send any one of the following institutional codes, but if you choose to send one, you may only send one code.</p>				

Tag Name	Schema Use	Description	Recommended Use	Format
OPEID	Optional exclusive choice	The unique identifier assigned by the Office of Postsecondary Education for each data exchange partner.	Recommended (use one)	minOcc 0 maxOcc 1 minLength 3 maxLength 8
Comment: This is an acceptable choice for an override school for the high school transcript if the courses taken were taken at a postsecondary institution.				
NHELPIP	Optional exclusive choice	The unique identifier assigned by National Council on Higher Education Loan Programs for each data exchange partner.	Not Recommended	minOcc 0 maxOcc 1 minLength 3 maxLength 8
Comment: This is not an acceptable choice for an override school for the high school transcript.				
IPEDS	Optional exclusive choice	The unique identifier assigned by the National Center for Education Statistics for the Integrated Postsecondary Education Data System for each postsecondary data exchange partner.	Recommended (use one)	minOcc 0 maxOcc 1 minLength 6 maxLength 6
Comment: This is an acceptable choice for an override school for the high school transcript if the courses taken were taken at a postsecondary institution.				
ATP	Optional exclusive choice	The unique identifier assigned for the Admissions Testing Program by the College Board for each postsecondary data exchange partner.	Recommended (use one)	minOcc 0 maxOcc 1 minLength 6 maxLength 6
Comment: This is an acceptable choice for an override school for the high school transcript if the courses taken were taken at a postsecondary institution.				
FICE	Optional exclusive choice	The unique identifier assigned for the Federal Interagency Committee on Education by the US Department of Education's National Center for Education Statistics for each postsecondary data exchange partner	Recommended (use one)	minOcc 0 maxOcc 1 minLength 6 maxLength 6
Comment: This is an acceptable choice for an override school for the high school transcript if the courses taken were taken at a postsecondary institution.				
ACT	Optional exclusive choice	The unique identifier assigned by the American College Testing or ACT for each postsecondary data exchange partner. See www.act.org.	Recommended (use one)	minOcc 0 maxOcc 1 minLength 4 maxLength 4
Comment: This is an acceptable choice for an override school for the high school transcript if the courses taken were taken at a postsecondary institution.				
CCD	Optional exclusive choice	The unique identifier assigned by the US Department of Education's National Center for Education Statistics as the Common Core of Data for each K12 data exchange partner.	Recommended (use one)	minOcc 0 maxOcc 1 minLength 12 maxLength 12
CEEBACT	Optional exclusive choice	The unique identifier assigned by the College Entrance Examining Board and ACT for each data exchange partner.	Recommended (use one)	minOcc 0 maxOcc 1 minLength 6 maxLength 6
CSIS	Optional exclusive choice	The unique identifier assigned by the Statistics Canada Canadian College Student Information System for each data exchange partner	Recommended (use one)	minOcc 0 maxOcc 1 minLength 6 maxLength 6

Tag Name	Schema Use	Description	Recommended Use	Format
USIS	Optional exclusive choice	The unique identifier assigned by the Statistics Canada University Student Information System for each data exchange partner	Recommended (use one)	minOcc 0 maxOcc 1 minLength 6 maxLength 6
ESIS	Optional exclusive choice	The unique identifier assigned by the Statistics Canada Enhanced Student Information System for each data exchange partner.	Recommended (use one)	minOcc 0 maxLength 1 minLength 8 maxLength 8
DUNS	Optional exclusive choice	Data Universal Numbering System (DUNS), unique nine character company identification number issued by Dun and Bradstreet Corporation.	Not Recommended	minOcc 0 maxOcc 1 minLength 9 maxLength 9
LocalOrganizationID	Optional	A code set typically used by a state, province or region to further identify the school whose record is beng sent	Optional	minOcc 0 maxOcc 1
Comment: This complex data element will be expanded on page XXX which follows.				
SchoolOverrideCode	Optional	The source of the academic credit if not awarded by the home or parent institution. Institutional – Institutional Agreement Multicampus – Multiple Campus Course Offering Transfer – Transfer Credit StudyAbroad – Study Abroad Coop – Cooperative Program Reciprocal – Reciprocal Exchange Internship – Internship	Recommended	minOcc 0 maxOcc 1 Enumerations: Institutional Multicampus Transfer StudyAbroad Coop Reciprocal Internship
SchoolLevel	Optional	Indicates level of Override School	Recommended	minOcc 0 maxOcc 1 Enumerations: Elementary Secondary Postsecondary
Contacts	Optional Repeatable	Contact info at Override School	Optional	minOcc 0 maxOcc ∞
Comment: This complex data element will be expanded on page XXX which follows.				
NoteMessage	Optional Repeatable	Additional information about the Override School	Not Recommended	minOcc 0 maxOcc ∞ minLength 1 maxLength 80
Comment: This is not the recommended place in the schema to include information about the school that is sending the student transcript. The recommended place in the schema for that information is under TransmissionData.Source. This is the place to send information about an override school. A typical use would be to indicate the school here that offered courses that the student transferred in to the sending school.				

Code illustration:

```

<School>
  <OrganizationName>New Trier Township High School</OrganizationName>
  <CEEBACT>144430</CEEBACT>
  <LocalOrganizationID>

  </LocalOrganizationID>
  <SchoolLevel>Secondary</SchoolLevel>
  <Contacts>

  </Contacts>
  <NoteMessage />
</School>
    
```

Student.AcademicRecord.School.LocalOrganizationID

Note: Although LocalOrganizationID is an optional complex data element, if it is included, then both the LocalOrganizationIDCode and the LocalOrganizationIDQualifier must be included.

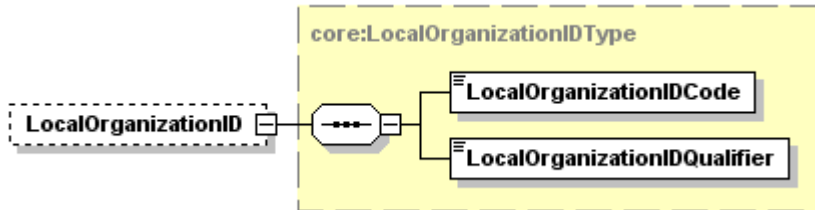

Tag Name	Schema Use	Description	Recommended Use	Format
LocalOrganizationIDCode	Required	The code assigned for the school by the state, province or other mutually defined agency specified in the Local Organization ID Qualifier that follows.	Required	minOcc 1 maxOcc 1 minLength 1 maxLength 35
<p>Comment: This is a required data element only if the Local Organization ID data element is sent. This is typically the administrative school code assigned by a state or province to specifically identify the override school in that state. If it is not assigned by a state or province, then code ZZ should be used in the Local Organization ID Qualifier that follows.</p>				
LocalOrganizationIDQualifier	Required	This is the state, province or other mutually defined agency that assigned the Local Organization ID Code above.	Required	minOcc 1 maxOcc 1 Enumerations: See Appendix A
<p>Comment: This is a required data element only if the Local Organization ID data element is sent. This is typically the state or province that assigned the code to specifically identify the receiving school in that state. If it is not assigned by a state or province, then code ZZ should be used in this data element</p>				

Code illustration:

```
<LocalOrganizationID>
  <LocalOrganizationIDCode>12345678</LocalOrganizationIDCode>
  <LocalOrganizationIDQualifier>IL</LocalOrganizationIDQualifier>
</LocalOrganizationID>
```

Student.AcademicRecord.School.Contacts

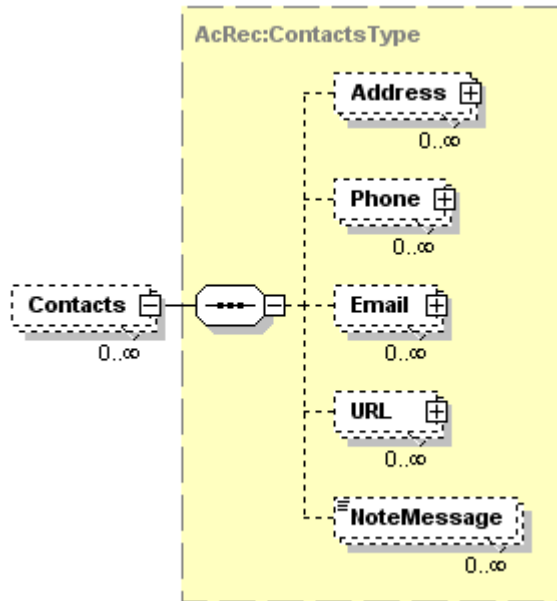

Tag Name	Schema Use	Description	Recommended Use	Format
Address	Optional Repeatable	Address of the Override School	Recommended	minOcc 0 maxOcc ∞
Comment: This complex data element will be expanded on page XXX which follows.				
Phone	Optional Repeatable	Phone Number of the Override School	Optional	minOcc 0 maxOcc ∞
Comment: This complex data element will be expanded on page XXX which follows.				
Email	Optional Repeatable	Email Address of the Override School	Optional	minOcc 0 maxOcc ∞
Comment: This complex data element will be expanded on page XXX which follows.				
URL	Optional Repeatable	Universal Resource Locator of the Override School	Optional	minOcc 0 maxOcc ∞
Comment: This complex data element will be expanded on page XXX which follows.				
NoteMessage	Optional Repeatable	Additional information about the contacts at the Override School	Not Recommended	minOcc 0 maxOcc ∞ minLength 1 maxLength 80

Student.AcademicRecord.School.Contacts (Continued)

Code illustration:

```
<Contacts>
  <Address>

    </Address>
    <Phone>

    </Phone>
    <Email>

    </Email>
    <URL>

    </URL>
    <NoteMessage />
</Contacts>
```

Student.AcademicRecord.School.Contacts.Address

Note: Although the complex data element Address is an optional data element, if you choose to send the Address of an Override School for the Academic Record, then you must send AddressLine and City and also StateProvinceCode, and PostalCode OR CountryCode.

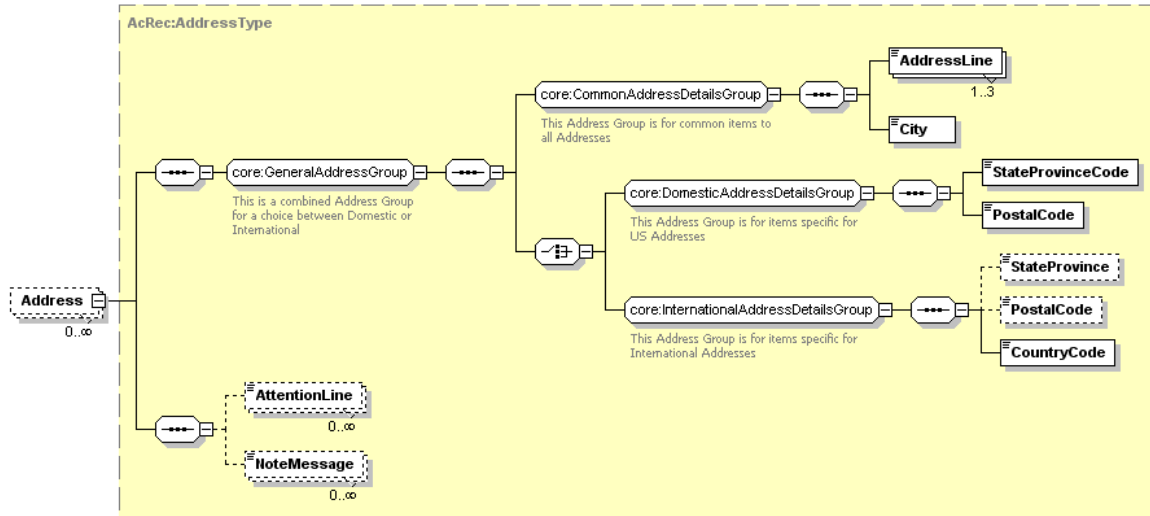

Tag Name	Schema Use	Description	Recommended Use	Format
<i>GeneralAddressGroup</i>	Required	This Address Group is for items common to all Addresses	Required	minOcc 1 maxOcc 1
Comment: [<i>GeneralAddressGroup</i>] does not appear in the instance document. It requires the use of <i>CommonAddressDetailsGroup</i> and the choice of one of either <i>DomesticAddressDetailsGroup</i> or <i>InternationalAddressDetailsGroup</i> . This group is required in the schema only if you choose to send the address of the contact.				
<i>CommonAddressDetailsGroup</i>	Required	This Address Group is for items common to all Addresses	Required	minOcc 1 maxOcc 1
Comment: [<i>CommonAddressDetailsGroup</i>] does not appear in the instance document. If the address of a contact is included in the transcript, then this must be sent. It is required and must be paired with one of either <i>DomesticAddressDetailsGroup</i> or <i>InternationalAddressDetailsGroup</i> .				
<i>AddressLine</i>	Required Repeatable	Local delivery information such as street, building number, PO box, or apartment portion of a postal address of a Contact at the Sending (Source) High School.	Required	minOcc 1 maxOcc 3 minLength 1 maxLength 40
<i>City</i>	Required	The city portion of the Address of a Contact at the Sending (Source) High School.	Required	minOcc 1 maxOcc 1 minLength 2 maxLength 30
<i>DomesticAddressDetailsGroup</i>	Required choice	This Address Group is for items specific for US and Canadian Addresses	Required for domestic addresses	minOcc 1 maxOcc 1
Comment: [<i>DomesticAddressDetailsGroup</i>] does not appear in the instance document. If the complex data element address has a United States or Canadian Postal Code and a US State or Canadian Province Code, then this should be the required choice.				

Tag Name	Schema Use	Description	Recommended Use	Format
StateProvinceCode	Required	Code for US states, etc., and Canadian provinces.	Required	minOcc 1 maxOcc 1 Enumerations: See Appendix A
PostalCode	Required	The postal code portion of the Address.	Required	minOcc 1 maxOcc 1 minLength 1 maxLength 17
<i>InternationalAddressDetailsGroup</i>	Required choice	This Address Group is for items specific for International Addresses	Required for international addresses	minOcc 1 maxOcc 1
Comment: [InternationalAddressDetailsGroup] does not appear in the instance document. This choice is for addresses that do not have a US or Canadian postal code.				
StateProvince	Optional	The literal name of the state, province or territory of a postal address of the source of this document. Use for addresses outside US or Canada.	Recommended Refer to common postal practices of the source country	minOcc 0 maxOcc 1 minLength 2 maxLength 30
Comment: For an internet resource of states or other geographical subdivisions in countries other than the US and Canada, you might choose to refer to the website of the Universal Postal Union at http://www.upu.int				
PostalCode	Optional	The postal code portion of the Address	Recommended Refer to common postal practices of the source country	minOcc 0 maxOcc 1 minLength 1 maxLength 17
Comment: For an internet resource of states or other geographical subdivisions in countries other than the US and Canada, you might choose to refer to the website of the Universal Postal Union at http://www.upu.int				
CountryCode	Required	Code indicating Country. Use ISO 3166-1 alpha-2 standard.	Required	minOcc 1 maxOcc 1 Enumerations: See Appendix B
AttentionLine	Optional	The individual or office name within the postal address where inquiries should be directed.	Optional	minOcc 1 maxOcc ∞ minLength 1 maxLength 45
Comment: This might be used to indicate where questions about the record should be sent. For example, <i>Principal, Guidance Counselor, Headmaster, etc.</i>				
NoteMessage	Optional Repeatable	Additional information about the addresses of the contacts at the source school	Not recommended	minOcc 0 maxOcc ∞ minLength 1 maxLength 80

Student.AcademicRecord.School.Contacts.Address (Continued)

Code illustration 1 (Domestic Address):

```
<Address>  
  <AddressLine>1715 W Cesar Chavez</AddressLine>  
  <City>Austin</City>  
  <StateProvinceCode>TX</StateProvinceCode>  
  <PostalCode>78703</PostalCode>  
  <AttentionLine>Jane Doe</AttentionLine>  
    <AttentionLine>GuidanceCounselor</AttentionLine>  
  <NoteMessage />  
</Address>
```

Code illustration 2 (International Address):

```
<Address>  
  <AddressLine>Altova Corporation</AddressLine>  
  <AddressLine>Rudolfsplatz 13a/9</AddressLine>  
  <City>Wien</City>  
  <StateProvince />  
  <PostalCode>A-1010</PostalCode>  
  <CountryCode>AT</CountryCode>  
</Address>
```

Student.AcademicRecord.School.Contacts.Phone

Note: Although Phone is an optional complex data element, if it is included, then the data element PhoneNumber must be included.

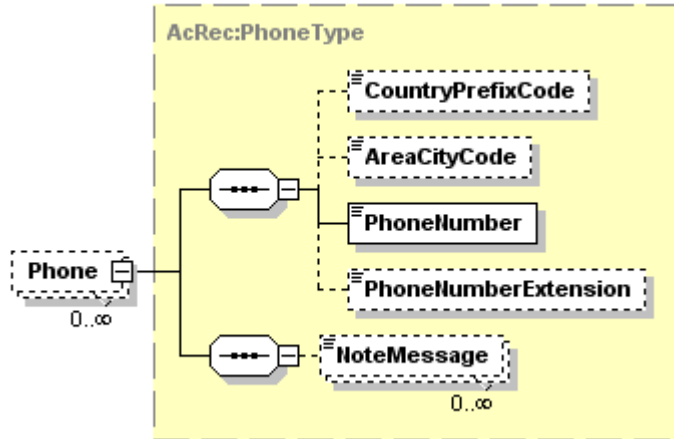

Tag Name	Schema Use	Description	Recommended Use	Format
CountryPrefixCode	Optional	International dialing code.	Optional	minOcc 0 maxOcc 1 minLength 1 maxLength 3
Comment: For example, the international dialing code for phone numbers in the US is "1". These codes are typically found in the information pages in the front of a telephone directory for a city or area.				
AreaCityCode	Optional	Regional dialing code.	Recommended	minOcc 0 maxOcc 1 minLength 1 maxLength 5
PhoneNumber	Required	Telephone number.	Required	minOcc 1 maxOcc 1 minLength 1 maxLength 11
Comment: The phone number is normally sent as a string of 7 numbers with no dashes or periods.				
PhoneNumberExtension	Optional	The extended telephone addressing information used in addition to phone number such as a PBX extension, a pager PIN, or FAX sub-address.	Optional	minOcc 0 maxOcc 1 minLength 1 maxLength 5
NoteMessage	Optional Repeatable	Additional information about the phone number of the Override School	Not recommended	minOcc 0 maxOcc ∞ minLength 1 maxLength 80

Code illustration:

```
<Phone>
  <CountryPrefixCode />
  <AreaCityCode>512</AreaCityCode>
  <PhoneNumber>4757638</PhoneNumber>
  <PhoneNumberExtension />
  <NoteMessage />
</Phone>
```

Student.AcademicRecord.School.Contacts.Email

Note: Although Email is an optional complex data element, if it is included, then the data element EmailAddress must be included.

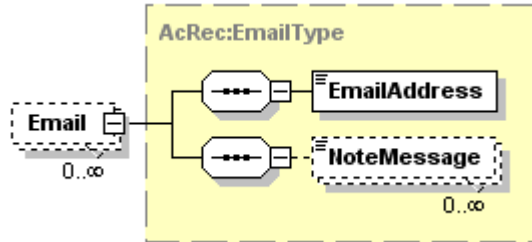

Tag Name	Schema Use	Description	Recommended Use	Format
EmailAddress	Required	The numbers, letters, and symbols used to identify an electronic mail (Email) user within a network	Required	minOcc 1 maxOcc 1 minLength 1 maxLength 128
NoteMessage	Optional Repeatable	Additional information about the email address of the Override School	Not recommended	minOcc 0 maxOcc ∞ minLength 1 maxLength 80

Code illustration:

```
<Email>
  <EmailAddress>Registrar@School.edu</EmailAddress>
  <NoteMessage />
</Email>
```

Student.AcademicRecord.School.Contacts.URL

Note: Although URL is an optional complex data element, if it is included, then the data element URLAddress must be included.

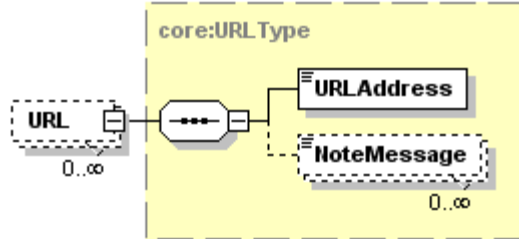

Tag Name	Schema Use	Description	Recommended Use	Format
URLAddress	Required	The Uniform Resource Locator (URL) address associated with a product, deliverable or contact.	Required	minOcc 1 maxOcc 1 minLength 0 maxLength 512
NoteMessage	Optional Repeatable	Additional information about the Uniform Resource Locator address of the Override School	Not recommended	minOcc 0 maxOcc ∞ minLength 1 maxLength 80

Code illustration:

```
<URL>
  <URLAddress>http://www.natick.k12.ma.us/schools/nhs</URLAddress>
  <NoteMessage />
</URL>
```

Student.AcademicRecord.StudentLevel

Note: Although StudentLevel is an optional complex data element, if it is included, then the data element StudentLevelCode must be included.

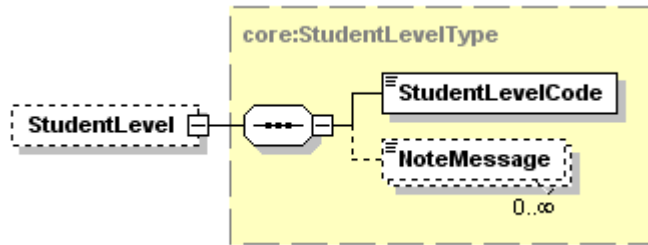

Tag Name	Schema Use	Description	Recommended Use	Format
StudentLevelCode	Required	The current grade level of the student or the highest grade level attained by the student at the time the record was created.	Required	minOcc 1 maxOcc 1 Enumerations: SeventhGrade EighthGrade NinthGrade TenthGrade EleventhGrade TwelfthGrade
NoteMessage	Optional Repeatable	Additional information about the student's grade level	Not Recommended	minOcc 0 maxOcc ∞ minLength 1 maxLength 80

Code illustration:

```

<StudentLevel>
  <StudentLevelCode>EighthGrade</StudentLevelCode>
  <NoteMessage />
</StudentLevel>
    
```

Student.AcademicRecord.AcademicAward

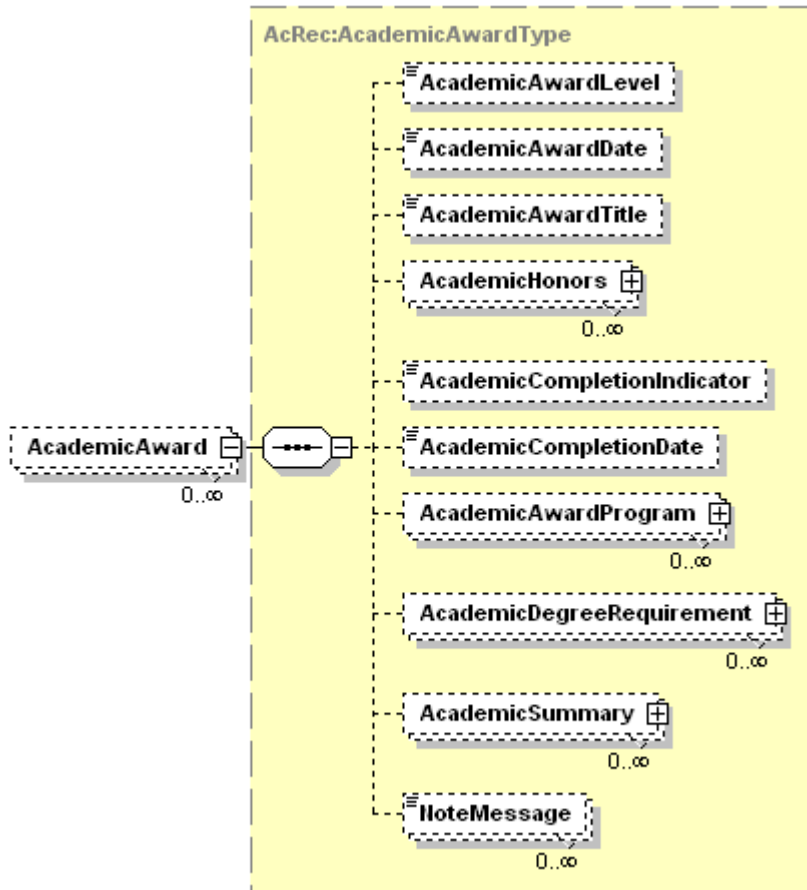

Tag Name	Schema Use	Description	Recommended Use	Format
AcademicAwardLevel	Optional	<p>The level of the degree, certificate, or award granted for the successful completion of requirements of an academic program.</p> <p>B17 Did not complete secondary school</p> <p>B18 Standard High School Diploma which may or may not include an exit test</p> <p>B19 Advanced or honors diploma</p> <p>B20 Vocational diploma</p> <p>B21 Special Education Diploma normally for students with a disability</p> <p>B22 Certificate of completion or attendance</p> <p>B23 Special certificate of completion or attendance</p> <p>B24 General Education Development (GED) Diploma</p> <p>B25 Other high school equivalency diploma</p>	Recommended	<p>minOcc 0</p> <p>maxOcc 1</p> <p>Enumerations:</p> <p>B17</p> <p>B18</p> <p>B19</p> <p>B20</p> <p>B21</p> <p>B22</p> <p>B23</p> <p>B24</p> <p>B25</p> <p>B26</p> <p>B27</p> <p>B28</p>

Tag Name	Schema Use	Description	Recommended Use	Format
		B26 International diploma or certificate such as International Baccalaureate B27 Standard High School Diploma with only 3 year curriculum B28 Met all graduation requirements except for required exit test		
AcademicAwardDate	Optional	The date on which the academic award was conferred.	Recommended	minOcc 0 maxOcc 1 xs:date
Comment: This is the nominal date when the award was granted. It might not be the same as the actual date of completion of the award requirements. The format for date is ccyy-mm-dd. This field can be used for an anticipated graduation date if a value of "false" is also included in the "ApplicationCompletionIndicator" which follows below.				
AcademicAwardTitle	Optional	The descriptive title for the academic award.	Recommended	minOcc 0 maxOcc 1 minLength 1 maxLength 80
Comment: The typical title for the award on a high school transcript would be "Diploma."				
AcademicHonors	Optional Repeatable	Honors information for the academic award.	Recommended	minOcc 0 maxOcc ∞
Comment: This complex data element will be expanded on page XXX which follows.				
AcademicCompletionIndicator	Optional	An indication that the degree-seeking student completed all of the requirements for his or her academic program. Not used for Non-Degree programs.	Recommended	minOcc 0 maxOcc 1 true/false
Comment: The value is "true" or "false" with all letters in lower case. The "true" condition would typically be met on or before the date indicated in the "AcademicAwardDate" field, if that field is sent. If neither the completion date nor the award date is included, then sending this indicator is even more important. If an anticipated graduation date is sent in the field AcademicAwardDate above, then it is important that this data element be included with a value of "false".				
AcademicCompletionDate	Optional	The date on which the student's requirements for the degree were met or completed.	Recommended	minOcc 0 maxOcc 1 xs:date
Comment: This is the actual date when all requirements for the award were completed. It might not be the same as the nominal date of the award. The format for date is ccyy-mm-dd.				
AcademicAwardProgram	Optional Repeatable	Information related to the specific area of study (e.g., major) under which the award was granted.	Optional	minOcc 0 maxOcc ∞
Comment: The academic award program is not normally included in a high school transcript. This complex data element will be expanded on page XXX which follows.				
AcademicDegreeRequirement	Optional Repeatable	Thesis or dissertation information if required for the award.	Not Recommended	minOcc 0 maxOcc ∞
Comment: Thesis or dissertation is not appropriate for the high school transcript.				
AcademicSummary	Optional Repeatable	Academic summary information pertaining to the award or diploma.	Optional	minOcc 0 maxOcc ∞
Comment: This complex data element will be expanded on page XXX which follows.				

Tag Name	Schema Use	Description	Recommended Use	Format
NoteMessage	Optional Repeatable	Additional information about the academic award	Not Recommended	minOcc 0 maxOcc ∞ minLength 1 maxLength 80

Comment: It is the recommendation of the Workgroup, that this is the most appropriate place to include academic awards, such as the awarding of a high school diploma. If it is included here, it will facilitate the processing of the award by the recipient.

Code illustration:

```

<AcademicAward>
  <AcademicAwardLevel>B18</AcademicAwardLevel>
  <AcademicAwardDate>1990-05-09</AcademicAwardDate>
  <AcademicAwardTitle>Diploma</AcademicAwardTitle>
  <AcademicHonors>

  </AcademicHonors>
  <AcademicCompletionIndicator>true</AcademicCompletionIndicator>
  <AcademicCompletionDate>1990-05-01</AcademicCompletionDate>
  <AcademicAwardProgram>

  </AcademicAwardProgram>
  <AcademicDegreeRequirement>

  </AcademicDegreeRequirement>
  <AcademicSummary>

  </AcademicSummary>
  <NoteMessage />
</AcademicAward>
    
```

Student.AcademicRecord.AcademicAward.AcademicHonors

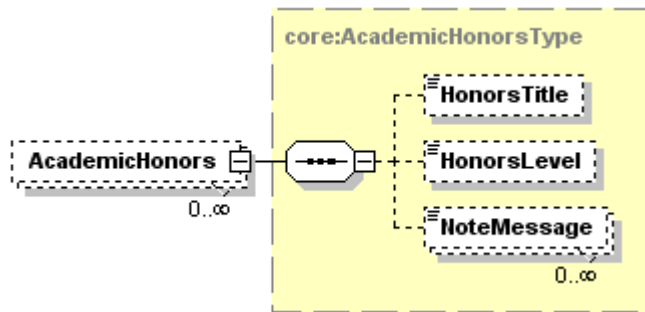

Tag Name	Schema Use	Description	Recommended Use	Format
HonorsTitle	Optional	The descriptive title for the honors received.	Recommended	minOcc 0 maxOcc 1 minLength 1 maxLength 30
Comment: There is a variety of names for these honors in the United States. Some common ones are "Valdictorian", "Salutatorian", "With Honors", "Magna Cum Laude", etc.				
HonorsLevel	Optional	A code value representing 1st highest honor, 2nd highest and 3rd highest.	Recommended	minOcc 0 maxOcc 1 Enumerations: FirstHighest SecondHighest ThirdHighest
Comment: Honors Level is critical to understanding the context of Honors Title.				
NoteMessage	Optional Repeatable	Additional information about the academic honors	Not Recommended	minOcc 0 maxOcc ∞ minLength 1 maxLength 80
Comment: The information about the award would normally be included with the overall academic record. Then, in that case, this is the appropriate place to include any honors associated with the award of the high school diploma.				

Code illustration:

```

<AcademicHonors>
  <HonorsTitle>With Honors</HonorsTitle>
  <HonorsLevel>ThirdHighest</HonorsLevel>
  <NoteMessage />
</AcademicHonors>
    
```

Student.AcademicRecord.AcademicAward.AcademicAwardProgram

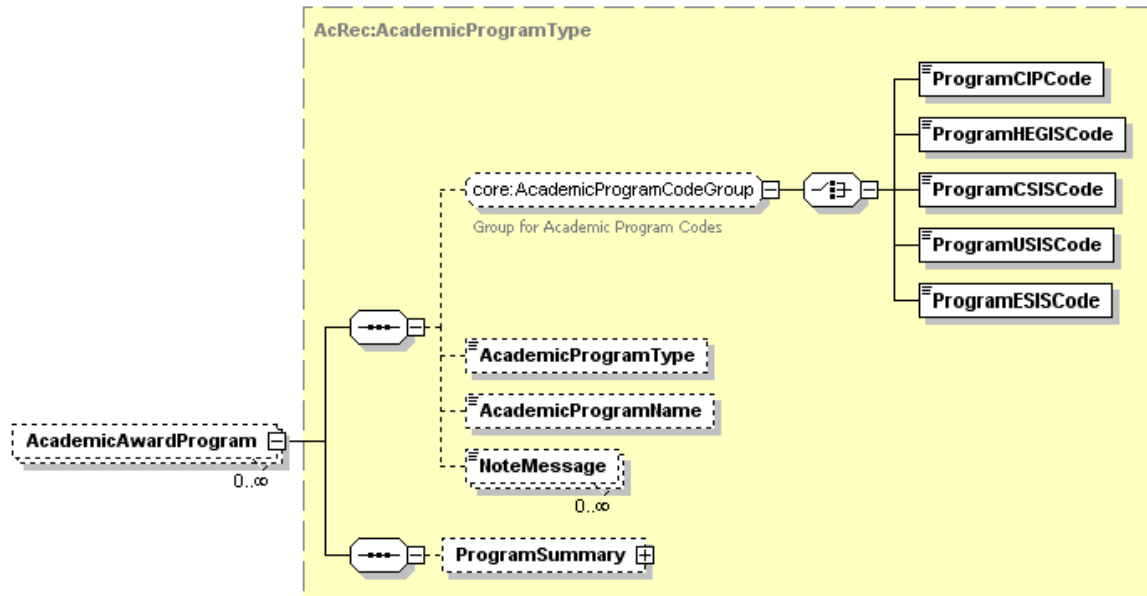

Tag Name	Schema Use	Description	Recommended Use	Format
Comment: Although none of the five optional choices immediately below is really appropriate for indicating academic programs at US High Schools, if one were to be sent, only one choice is allowable.				
ProgramCIPCode	Optional exclusive choice	Code indicating a discipline or field of study assigned by the Classification of Instructional Programs for Postsecondary Institutions	Not Recommended	minOcc 0 maxOcc 1 minLength 6 maxLength 20
ProgramHEGISCode	Optional exclusive choice	Code indicating a discipline or field of study assigned by Higher Education General Information Survey	Not Recommended	minOcc 0 maxOcc 1 minLength 6 maxLength 20
ProgramCSISCode	Optional exclusive choice	Code indicating a discipline or field of study assigned by Statistics Canada Canadian College Student Information System	Not Recommended	minOcc 0 maxOcc 1 minLength 5 maxLength 5
ProgramUSISCode	Optional exclusive choice	Code indicating a discipline or field of study assigned by the Statistics Canada University Student Information System.	Not Recommended	minOcc 0 maxOcc 1 minLength 5 maxLength 5
ProgramESISCode	Optional exclusive choice	Code indicating a discipline or field of study assigned by the Statistics Canada Enhanced Student Information System.	Not Recommended	minOcc 0 maxOcc 1 minLength 1 maxLength 20
Comment: None of the above five optional choices is really appropriate for indicating academic programs at US High Schools.				
AcademicProgramType	Optional	Indicates whether the academic program is a major, minor, area of concentration or specialization.	Optional	minOcc 0 maxOcc 1 Enumerations: Concentration Major Minor Specialization

Tag Name	Schema Use	Description	Recommended Use	Format
AcademicProgramName	Optional	Literal name of program, major, or field of study.	Optional	minOcc 0 maxOcc 1 minLength 1 maxLength 60
NoteMessage	Optional Repeatable	Additional information about the Academic Award Program	Not Recommended	minOcc 0 maxOcc ∞ minLength 1 maxLength 80
ProgramSummary	Optional	Summary information about the Academic Award Program	Optional	minOcc 0 maxOcc 1

Comment: This entire portion of the schema, which describes a student's high school academic program, is not normally included in a high school transcript.

Code illustration:

```

<AcademicAwardProgram>
  <ProgramCIPCode />
  <AcademicProgramType>Major</AcademicProgramType>
  <AcademicProgramName>General Academic Transfer</AcademicProgramName>
  <NoteMessage />
  <ProgramSummary>

  </ProgramSummary>
</AcademicAwardProgram>
    
```

Student.AcademicRecord.AcademicAward.AcademicAwardProgram. ProgramSummary

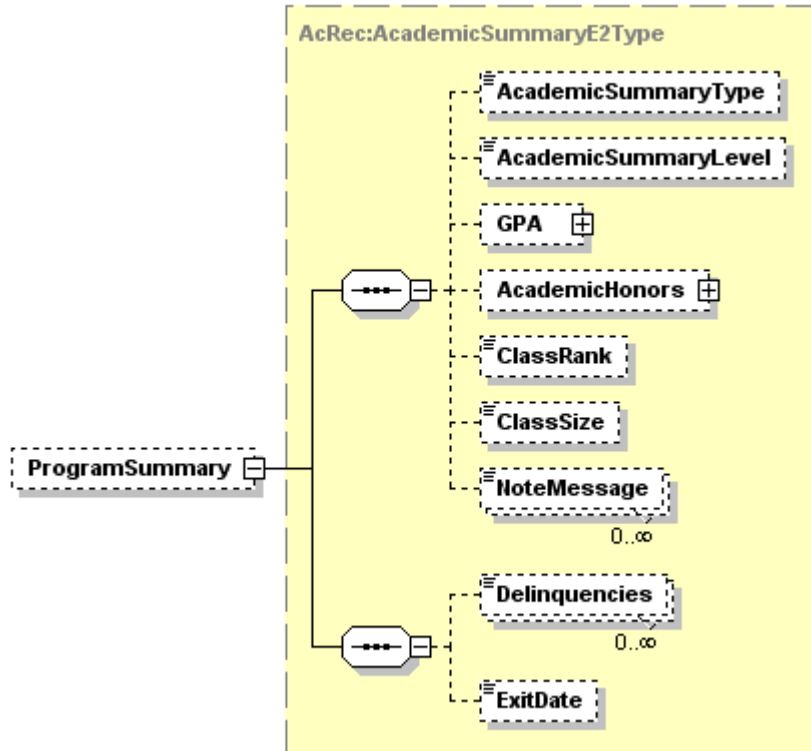

Tag Name	Schema Use	Description	Recommended Use	Format
AcademicSummaryType	Optional	<p>Summary Type is an indication of what is being summarized over which period of time.</p> <p><i>All</i> – Summary of all courses regardless of institution <i>SenderOnly</i> – Summary of all courses at sending institution (or recorded as if they were taken at the sending institution) <i>TransferOnly</i> – Summary of transfer work (courses taken at other than the sending institution) <i>AllNotRepeated</i> – Summary of all courses except for repeated or forgiven courses/credits <i>SenderNotRepeated</i> – Summary of all courses at sending institution except repeated or forgiven courses/credits <i>TransferNotRepeated</i> – Summary of transfer work except for repeated or forgiven courses/credits <i>AcademicRenewal</i> – Subset of forgiven courses if the high school has a policy that allows for portion of the academic record to be excluded from the total credits used to compute the grade point average and to also be excluded from the credits earned toward the diploma. This is not very common in high schools.</p>	Optional	<p>minOcc 0 maxOcc 1</p> <p>Enumerations: All SenderOnly TransferOnly AllNotRepeated SenderNotRepeated TransferNotRepeated AcademicRenewal CarryoverCredit DegreeApplicable NonDegreeApplicable ConvertedFrom ConvertedTo UserDefined Weighted NonWeighted</p>

Tag Name	Schema Use	Description	Recommended Use	Format
		<p><i>CarryoverCredit</i> – Summary from offline records and used as the initial point for cumulatives and averages</p> <p><i>DegreeApplicable</i> – Summary of courses that apply to the diploma</p> <p><i>NonDegreeApplicable</i> – Summary of courses that do not apply toward degree</p> <p><i>ConvertedFrom</i> – Summary of credits before an institutional term-basis conversion, such as from quarters to semesters</p> <p><i>ConvertedTo</i> – Summary of credits after an institutional term-basis conversion, such as from quarters to semesters</p> <p><i>Weighted</i> – Summary that gives additional (higher) value to specific courses taken by a student, such as honors courses, International Baccalaureate, Advanced Placement, high school /college dual enrollment.</p> <p><i>NonWeighted</i> – Summary that does not give additional value to courses, regardless of special characteristics of the courses. For example, if the grading scale is from 0 to 4.00, then it is not possible to have a summary higher than 4.00.</p> <p><i>UserDefined</i> – Use NoteMessage for explanation</p>		
AcademicSummaryLevel	Optional	<p>The level of credit associated with the credit hours earned for the course.</p> <p><i>Undergraduate</i> – Undergraduate</p> <p><i>LowerDivision</i> – Lower division credit (associated with first/second year)</p> <p><i>UpperDivision</i> – Higher or upper division credit (associated with third or fourth year)</p> <p><i>Vocational</i> – Vocational/technical credit</p> <p><i>TechnicalPreparatory</i> – Tech Prep credit</p> <p><i>Graduate</i> – Graduate level credit</p> <p><i>Professional</i> – Professional</p> <p><i>Dual</i> – Dual level (upper division and graduate- may be applicable to a bachelor's degree or graduate degree or both)</p> <p><i>GraduateProfessional</i> – Dual level (graduate and professional- may be applicable to both)</p>	Not Recommended	<p>minOcc 0 maxOcc 1</p> <p>Enumerations: Undergraduate LowerDivision UpperDivision Vocational TechnicalPreparatory Graduate Professional Dual GraduateProfessional</p>
Comment: None of the above values is appropriate for the high school transcript.				
GPA	Optional	GPA for the Award Program	Optional	<p>minOcc 0 maxOcc 1</p>
Comment: This complex data element will be expanded on page XXX which follows.				
AcademicHonors	Optional	Honors for the Award Program	Recommended	<p>minOcc 0 maxOcc 1</p>
Comment: This complex data element will be expanded on page XXX which follows.				

Tag Name	Schema Use	Description	Recommended Use	Format
ClassRank	Optional	The student's class rank relative to other students in their academic cohort (e.g. class).	Recommended	minOcc 0 maxOcc 1 minInclusive 1 maxInclusive 9999 totalDigits 4
Comment: The student ranking the highest in the class would have a rank of "1".				
ClassSize	Optional	The numeric size of the academic cohort (e.g. class).	Recommended	minOcc 0 maxOcc 1 minInclusive 1 maxInclusive 9999 totalDigits 4
NoteMessage	Optional Repeatable	Additional information about the Program Summary	Optional	minOcc 0 maxOcc ∞ minLength 1 maxLength 80
Comment: If class rank and class size are provided, a note might be appropriate to describe the cohort and when the ranking occurred.				
Delinquencies	Optional Repeatable	The academic standing of the student upon transfer to the institution. <i>GoodStanding</i> - Student was in good standing <i>ProbationGPA</i> - Student was on academic probation (because of low GPA) <i>ProbationHours</i> - Student was on academic probation (deficiency in credit hours) <i>SuspensionGPA</i> - Student was on academic suspension (because of low GPA) <i>SuspensionHours</i> - Student was on academic suspension (deficiency in credit hours) <i>ProbationDiscipline</i> - Student was on disciplinary probation <i>SuspensionDiscipline</i> - Student was on disciplinary suspension <i>Unknown</i> <i>Other</i>	Not Recommended	minOcc 0 maxOcc ∞ Enumerations: GoodStanding ProbationGPA ProbationHours SuspensionGPA SuspensionHours ProbationDiscipline SuspensionDiscipline Unknown Other
ExitDate	Optional	The date on which the student officially withdrew or graduated.	Not Recommended	minOcc 0 maxOcc 1 xs:date
Comment: The format for the date is ccy-mm-dd.				
Comment: This section of the transcript refers to a summary of the academic record for the specific academic program the student took that was used for the academic award specified. This is not normally included in a high school transcript.				

Code illustration:

```

<ProgramSummary>
  <AcademicSummaryType>All</AcademicSummaryType>
  <AcademicSummaryLevel />
  <GPA>

  </GPA>
  <AcademicHonors>

  </AcademicHonors>
  <ClassRank>75</ClassRank>
  <ClassSize>254</ClassSize>
  <NoteMessage />
  <Delinquencies />
  <ExitDate />
</ProgramSummary>

```

Student.AcademicRecord.AcademicAward.AcademicAwardProgram.
ProgramSummary.GPA

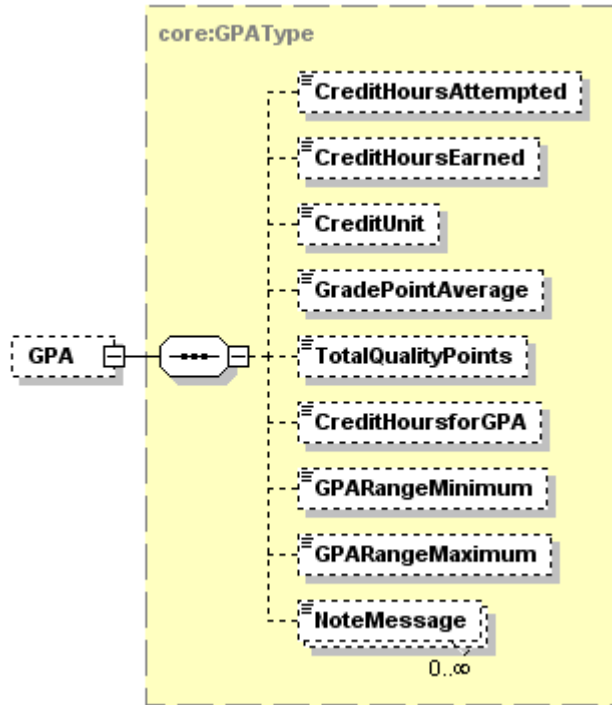

Tag Name	Schema Use	Description	Recommended Use	Format
CreditHoursAttempted	Optional	The total value of credit hours attempted whether or not included in the hours for GPA or hours earned.	Recommended	minOcc 0 maxOcc 1 xs:decimal
<p>Comment: This would also include the credit value of a course from which the student withdrew, if it appears on the transcript. So if a student had enrolled in 10 Carnegie Units which are all included in the specified program and appear on the transcript, and had passed 5 units and withdrawn from 5 units, then the value of this field would be "10". If the student had enrolled for 10.5 units that are included in this program and are on the transcript, then the value of this field would be "10.5".</p>				
CreditHoursEarned	Optional	The total value of credit hours successfully completed or earned.	Recommended	minOcc 0 maxOcc 1 xs:decimal
<p>Comment: If the student had earned 5 Carnegie Units and they all counted toward this program for this diploma, then the value of this data element would be "5". If only 4.5 units were earned, then the value would be "4.5".</p>				
CreditUnit	Optional	The type of credit (unit, semester, or quarter) associated with the credit hours earned for the course.	Recommended	minOcc 0 maxOcc 1 Enumerations: NoCredit Quarter Semester Units ClockHours CarnegieUnits ContinuingEducationUnits Unreported Other
<p>Comment: Note that the credit unit is not necessarily directly related to the type of session in which a course is offered. A full year course, or a semester course, or a quarter course, may all offer Carnegie Units or Units as the credit unit.</p>				

Tag Name	Schema Use	Description	Recommended Use	Format
GradePointAverage	Optional	The value of the total quality points divided by the Credit Hours for Grade Point Average.	Recommended	minOcc 0 maxOcc 1 xs:decimal
Comment: For example, if the student had enrolled for 10 Carnegie Units that counted toward this diploma and this program, passed 8 units with grades of B worth 3 grade points for each Carnegie Unit, and 2 Carnegie Units with grades of F worth 0 grade points, then the calculation would be 24 grade points divided by 10 or a GPA of "2.4" or "2.40" or "2.400" depending on the policy of the sending school.				
TotalQualityPoints	Optional	The total value of quality points used for the calculation of the Grade Point Average.	Recommended	minOcc 0 maxOcc 1 xs:decimal
Comment: If a student earned all grades of B (worth 3 grade points for each Carnegie Unit) in 8.5 Carnegie Units that count toward this diploma and this program, then the value of this data element would be "25.5".				
CreditHoursforGPA	Optional	The total value of credit hours used to calculate the Grade Point Average.	Recommended	minOcc 0 maxOcc 1 xs:decimal
Comment: If a student earned grades of A (worth 4 grades points per unit) in 3 Carnegie Units in this program for this diploma; grades of F (worth 0 points per unit) in 4 units; and withdrew from 5 units, then the total credit hours for GPA for this diploma and this program would be "7".				
GPARangeMinimum	Optional	The minimum possible GPA	Recommended	minOcc 0 maxOcc 1 xs:decimal
Comment: If the lowest possible grade is an F and a grade of F is valued at 0 grade points, then this value would be "0", or "0.0" or "0.00".				
GPARangeMaximum	Optional	The maximum possible GPA	Recommended	minOcc 0 maxOcc 1 xs:decimal
Comment: If the highest possible grade is an A and a grade of A is valued at 4 grade points, then this value would be "4" or "4.0" or "4.00", etc.				
NoteMessage	Optional Repeatable	Additional information about the GPA	Not Recommended	minOcc 0 maxOcc ∞ minLength 1 maxLength 80
Comment: A student's GPA for a specific program within the Award or Diploma would not normally be included in a high school transcript so this entire section of the schema would not normally be included.				

Code illustration:

```

<GPA>
  <CreditHoursAttempted>12</CreditHoursAttempted>
  <CreditHoursEarned>12</CreditHoursEarned>
  <CreditUnit>CarnegieUnits</CreditUnit>
  <GradePointAverage>3.75</GradePointAverage>
  <TotalQualityPoints>45</TotalQualityPoints>
  <CreditHoursforGPA>12</CreditHoursforGPA>
  <GPARangeMinimum>0</GPARangeMinimum>
  <GPARangeMaximum>4</GPARangeMaximum>
  <NoteMessage />
</GPA>
    
```

**Student.AcademicRecord.AcademicAward.AcademicAwardProgram.
ProgramSummary.AcademicHonors**

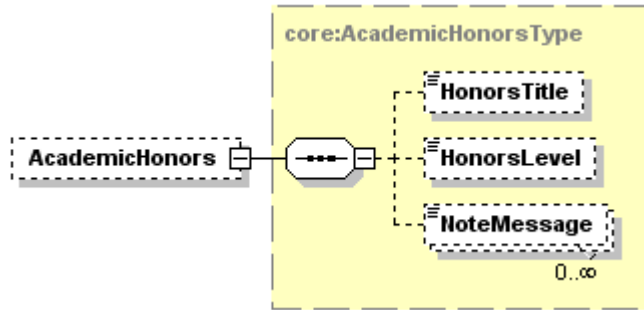

Tag Name	Schema Use	Description	Recommended Use	Format
HonorsTitle	Optional	The descriptive title for the honors received.	Not Recommended	minOcc 0 maxOcc 1 minLength 1 maxLength 30
HonorsLevel	Optional	A code value representing 1st highest honor, 2nd highest and 3rd highest.	Not Recommended	minOcc 0 maxOcc 1 Enumerations: FirstHighest SecondHighest ThirdHighest
NoteMessage	Optional Repeatable	Additional information about the Academic Honors	Not Recommended	minOcc 0 maxOcc 1 minLength 1 maxLength 80

Comment: This entire section of the schema for honors awarded for a specific program as part of a high school diploma would not normally be included on a high school transcript.

Code illustration:

```
<AcademicHonors>
  <HonorsTitle>Cum Laude</HonorsTitle>
  <HonorsLevel>ThirdHighest</HonorsLevel>
  <NoteMessage />
</AcademicHonors>
```

**Student.AcademicRecord.AcademicAward.
AcademicDegreeRequirement**

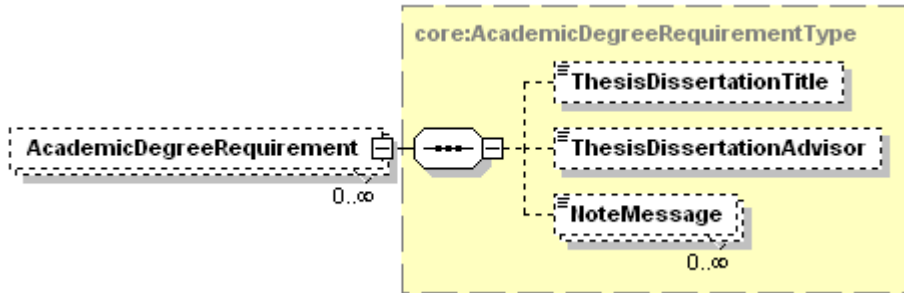

Tag Name	Schema Use	Description	Recommended Use	Format
ThesisDissertationTitle	Optional	The title of the thesis or dissertation.	Not Recommended	minOcc 0 maxOcc 1 minLength 1 maxLength
ThesisDissertationAdvisor	Optional	The advisor (Major Professor) who supervised the Thesis or Dissertation on behalf of the student earning the degree.	Not Recommended	minOcc 0 maxOcc 1 minLength 1 maxLength 45
NoteMessage	Optional Repeatable	Additional information about the Academic Degree Requirement	Not Recommended	minOcc 0 maxOcc ∞ minLength 1 maxLength 80

Comment: It is not recommended to include Academic Degree Requirement in the High School Transcript, since it is inappropriate.

Code illustration:

```
<AcademicDegreeRequirement>
  <ThesisDissertationTitle/>
  <ThesisDissertationAdvisor/>
  <NoteMessage />
</AcademicDegreeRequirement>
```

Student.AcademicRecord.AcademicAward.AcademicSummary

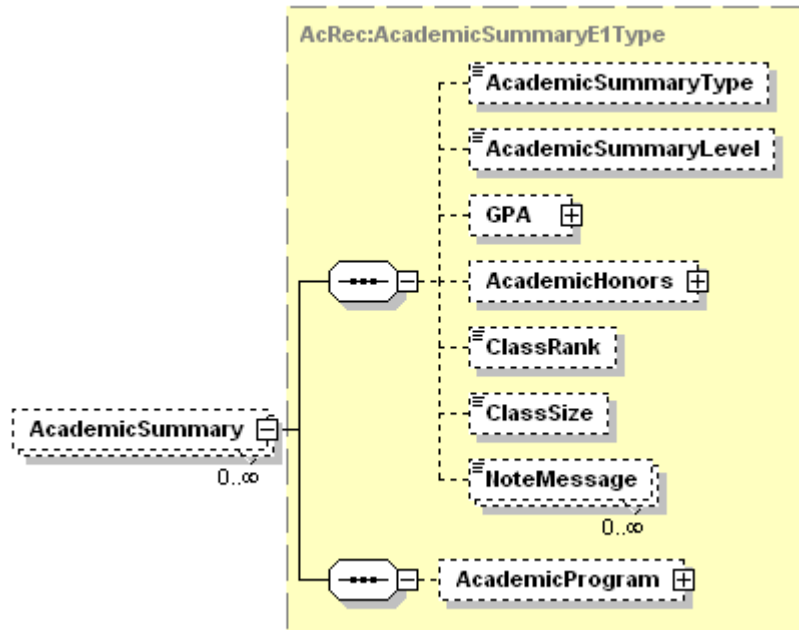

Tag Name	Schema Use	Description	Recommended Use	Format
AcademicSummaryType	Optional	<p>Summary Type is an indication of what is being summarized over what period of time</p> <p><i>All</i> - Summary of all courses regardless of institution</p> <p><i>SenderOnly</i> - Summary of all courses at sending institution (or recorded as if they were taken at the sending institution)</p> <p><i>TransferOnly</i> - Summary of transfer work (courses taken at other than the sending institution)</p> <p><i>AllNotRepeated</i> - Summary of all courses except for repeated or forgiven courses/credits</p> <p><i>SenderNotRepeated</i> - Summary of all courses at sending institution except for repeated or forgiven courses/credits</p> <p><i>TransferNotRepeated</i> - Summary of transfer work except for repeated or forgiven courses/credits</p> <p><i>AcademicRenewal</i> - Subset of forgiven courses</p> <p><i>CarryoverCredit</i> - Summary from offline records and used as the initial point for cumulatives and averages</p> <p><i>DegreeApplicable</i> - Summary of course that apply to degree</p> <p><i>NonDegreeApplicable</i> - Summary of courses that do not apply toward degree</p> <p><i>ConvertedFrom</i> - Summary of credits before an institutional term-basis conversion, such as from quarters to semesters</p>	Recommended	<p>minOcc 0</p> <p>maxOcc 1</p> <p>Enumerations:</p> <ul style="list-style-type: none"> All SenderOnly TransferOnly AllNotRepeated SenderNotRepeated TransferNotRepeated AcademicRenewal CarryoverCredit DegreeApplicable NonDegreeApplicable ConvertedFrom ConvertedTo UserDefined Weighted NonWeighted

Tag Name	Schema Use	Description	Recommended Use	Format
		<p><i>ConvertedTo</i> - Summary of credits after an institutional term-basis conversion, such as from quarters to semesters</p> <p><i>Weighted</i> – Summary that gives additional (higher) value to specific courses taken by a student, such as honors courses, International Baccalaureate, Advanced Placement, high school/college dual enrollment.</p> <p><i>NonWeighted</i> – Summary that does not give additional value to courses, regardless of special characteristics of the courses. For example, if the grading scale is from 0 to 4.00, then it is not possible to have a summary higher than 4.00.</p> <p>UserDefined - see NoteMessage for explanation</p>		
AcademicSummaryLevel	Optional	The level of credit associated with the credit hours earned for the course.	Not Recommended	minOcc 0 maxOcc 1 Enumerations: Undergraduate LowerDivision UpperDivision Vocational TechnicalPreparatory Graduate Professional Dual GraduateProfessional
Comment: These values are not appropriate for the High School Transcript.				
GPA	Optional	GPA for the Academic Award	Recommended	minOcc 0 maxOcc 1
Comment: This complex data element will be expanded on page XXX which follows.				
AcademicHonors	Optional	Honors for the Academic Award	Recommended	minOcc 0 maxOcc 1
Comment: This complex data element will be expanded on page XXX which follows.				
ClassRank	Optional	The student's class rank relative to other students in their academic cohort (e.g. class).	Recommended	minOcc 0 maxOcc 1 minInclusive 1 maxInclusive 9999 totalDigits 4
ClassSize	Optional	The numeric size of the academic cohort (e.g. class).	Recommended	minOcc 0 maxOcc 1 minInclusive 1 maxInclusive 9999 totalDigits 4
NoteMessage	Optional Repeatable	Additional information about the Academic Summary	Not Recommended	minOcc 0 maxOcc ∞ minLength 1 maxLength 80
AcademicProgram	Optional	Academic Program(s) related to this Academic Summary	Not Recommended	minOcc 0 maxOcc ∞
Comment: The academic program is not normally included in a high school transcript.				

Tag Name	Schema Use	Description	Recommended Use	Format
<p>Comment: While academic award programs and summaries can be communicated in several different elements, it is recommended that they be reported at the highest appropriate level. E.G., use <code>AcademicAward.AcademicAwardProgram</code> to indicate degree major; <code>AcademicAward.AcademicAwardProgram.ProgramSummary</code> for degree major GPA and honors; <code>AcademicAward.AcademicSummary</code> for degree GPA and honors. This would be the appropriate place in this schema to give information about the credits and GPA for the diploma that is awarded if the sending school does not include this in the academic session in which the diploma was awarded.</p>				

Code illustration:

```

<AcademicSummary>
  <AcademicSummaryType>All</AcademicSummaryType>
  <AcademicSummaryLevel>Undergraduate</AcademicSummaryLevel>
  <GPA>

  </GPA>
  <AcademicHonors>

  </AcademicHonors>
  <ClassRank>43</ClassRank>
  <ClassSize>849</ClassSize>
  <NoteMessage />
  <AcademicProgram>

  </AcademicProgram>
</AcademicSummary>
    
```

Student.AcademicRecord.AcademicAward.AcademicSummary.GPA

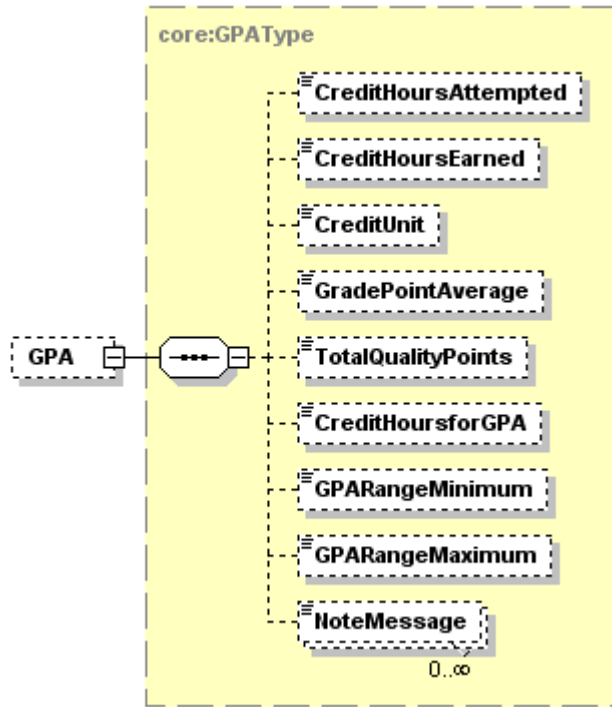

Tag Name	Schema Use	Description	Recommended Use	Format
CreditHoursAttempted	Optional	The total value of credit hours attempted whether or not included in the hours for GPA or hours earned.	Recommended	minOcc 0 maxOcc 1 xs:decimal
<p>Comment: This would include the credit value of a course from which the student withdrew, if it appears on the transcript. So if a student had enrolled in 10 Carnegie Units which are all included for this diploma and are on the transcript, and had passed 5 units and withdrawn from 5 units, then the value of this field would be "10". If the student had enrolled for 10.5 units that are included for this diploma and are on the transcript, then the value of this field would be "10.5".</p>				
CreditHoursEarned	Optional	The total value of credit hours successfully completed or earned.	Recommended	minOcc 0 maxOcc 1 xs:decimal
<p>Comment: If the student had earned 5 Carnegie Units and they all counted toward this diploma, then the value of this data element would be "5". If only 4.5 units were earned, then the value would be "4.5".</p>				
CreditUnit	Optional	The type of credit (unit, semester, or quarter) associated with the credit hours earned for the course.	Recommended	minOcc 0 maxOcc 1 Enumerations: NoCredit Quarter Semester Units ClockHours CarnegieUnits ContinuingEducationUnits Unreported Other
<p>Comment: Note that the credit unit is not necessarily directly related to the type of session in which a course is offered. A full year course, or a semester course, or a quarter course, may all offer Carnegie Units or Units as the credit unit.</p>				

Tag Name	Schema Use	Description	Recommended Use	Format
GradePointAverage	Optional	The value of the total quality points divided by the Credit Hours for Grade Point Average.	Recommended	minOcc 0 maxOcc 1 xs:decimal
Comment: For example, if the student had enrolled for 10 Carnegie Units that counted toward this diploma, passed 8 units with grades of B worth 3 grade points for each Carnegie Unit, and 2 Carnegie Units with grades of F worth 0 grade points, then the calculation would be 24 grade points divided by 10 or a GPA of "2.4" or "2.40" or "2.400" depending on the policy of the sending school.				
TotalQualityPoints	Optional	The total value of quality points used for the calculation of the Grade Point Average.	Recommended	minOcc 0 maxOcc 1 xs:decimal
Comment: If a student earned all grades of B (worth 3 grade points for each Carnegie Unit) in 8.5 Carnegie Units that count toward this diploma, then the value of this data element would be "25.5".				
CreditHoursforGPA	Optional	The total value of credit hours used to calculate the Grade Point Average.	Recommended	minOcc 0 maxOcc 1 xs:decimal
Comment: If a student earned grades of A (worth 4 grades points per unit) in 3 Carnegie Units for this diploma; grades of F (worth 0 points per unit) in 4 units; and withdrew from 5 units, then the total credit hours for GPA for this diploma would be "7".				
GPARangeMinimum	Optional	The minimum possible Grade Point Average	Recommended	minOcc 0 maxOcc 1 xs:decimal
Comment: If the lowest possible grade is an F and a grade of F is valued at 0 grade points, then this value would be "0", or "0.0" or "0.00", etc.				
GPARangeMaximum	Optional	The maximum possible Grade Point Average	Recommended	minOcc 0 maxOcc 1 xs:decimal
Comment: If the highest possible grade is an A and a grade of A is valued at 4 grade points, then this value would be "4" or "4.0" or "4.00", etc.				
NoteMessage	Optional Repeatable	Additional information about the GPA	Not Recommended	minOcc 0 maxOcc ∞ minLength 1 maxLength 80
Comment: The GPA reported in this section of the Schema is an overall GPA for all courses that count toward the diploma described in this section.				

Code illustration:

```

<GPA>
  <CreditHoursAttempted>159</CreditHoursAttempted>
  <CreditHoursEarned>136</CreditHoursEarned>
  <CreditUnit>Semester</CreditUnit>
  <GradePointAverage>3.0915</GradePointAverage>
  <TotalQualityPoints>473</TotalQualityPoints>
  <CreditHoursforGPA>153</CreditHoursforGPA>
  <GPARangeMinimum>0</GPARangeMinimum>
  <GPARangeMaximum>4</GPARangeMaximum>
  <NoteMessage />
</GPA>
    
```

Student.AcademicRecord.AcademicAward.AcademicSummary.AcademicHonors

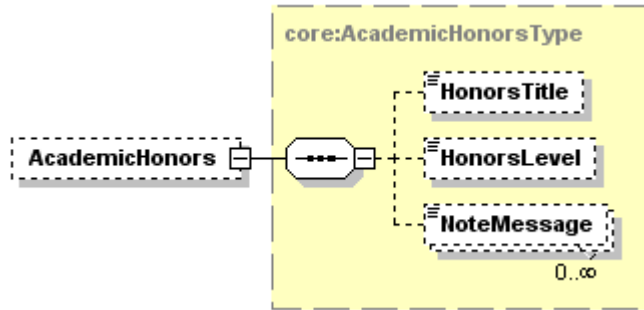

Tag Name	Schema Use	Description	Recommended Use	Format
HonorsTitle	Optional	The descriptive title for the honors received.	Recommended	minOcc 0 maxOcc 1 minLength 1 maxLength 30
<p>Comment: There is a great variety of titles for honors that are associated with the diploma being awarded. Among these are “Star Student”, “Sigma Alpha Tau”, “Salutatorian”, “Valedictorian”, “Summa Cum Laude”, “Magna Cum Laude”, “Cum Laude”, “With Highest Honors”, etc.</p>				
HonorsLevel	Optional	A code value representing 1st highest honor, 2nd highest and 3rd highest.	Recommended	minOcc 0 maxOcc 1 Enumerations: FirstHighest SecondHighest ThirdHighest
NoteMessage	Optional Repeatable	Additional information about the Academic Honors	Not Recommended	minOcc 0 maxOcc ∞ minLength 1 maxLength 80
<p>Comment: These are the academic honors associated with the diploma or other award described immediately above.</p>				

Code illustration:

```
<AcademicHonors>
  <HonorsTitle>Valedictorian</HonorsTitle>
  <HonorsLevel>FirstHighest</HonorsLevel>
  <NoteMessage />
</AcademicHonors>
```

Student.AcademicRecord.AcademicAward.AcademicSummary.AcademicProgram

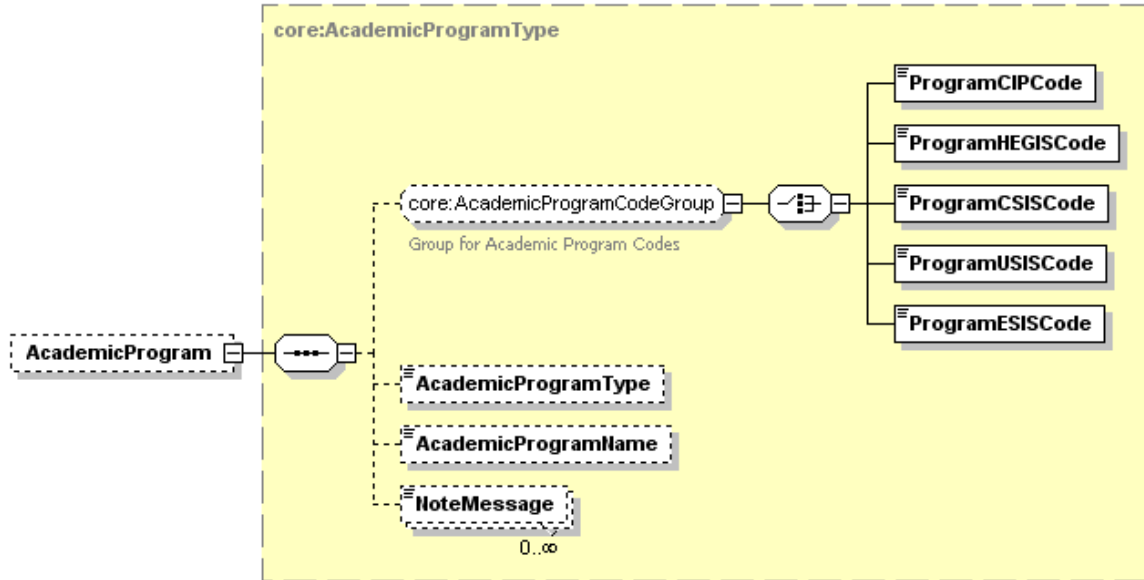

Tag Name	Schema Use	Description	Recommended Use	Format
ProgramCIPCode	Optional exclusive choice	Code indicating a discipline or field of study assigned by the Classification of Instructional Programs	Not Recommended	minOcc 0 maxOcc 1 minLength 6 maxLength 20
ProgramHEGISCode	Optional exclusive choice	Code indicating a discipline or field of study assigned by Higher Education General Information Survey	Not Recommended	minOcc 0 maxOcc 1 minLength 6 maxLength 20
ProgramCSISCode	Optional exclusive choice	Code indicating a discipline or field of study assigned by Statistics Canada Canadian College Student Information System	Not Recommended	minOcc 0 maxOcc 1 minLength 5 maxLength 5
ProgramUSISCode	Optional exclusive choice	Code indicating a discipline or field of study assigned by the Statistics Canada University Student Information System.	Not Recommended	minOcc 0 maxOcc 1 minLength 5 maxLength 5
ProgramESISCode	Optional exclusive choice	Code indicating a discipline or field of study assigned by the Statistics Canada Enhanced Student Information System.	Not Recommended	minOcc 0 maxOcc 1 minLength 1 maxLength 20
Comment: Although the above 5 choices for program codes are optional, none of them is appropriate to describe high school academic programs in the United States.				
AcademicProgramType	Optional	Indicates whether the academic program is a major, minor, area of concentration or specialization.	Optional	minOcc 0 maxOcc 1 Enumerations: Concentration Major Minor Specialization
AcademicProgramName	Optional	Literal name of program, major, or field of study.	Recommended	minOcc 0 maxOcc 1 minLength 1 maxLength 60

Tag Name	Schema Use	Description	Recommended Use	Format
NoteMessage	Optional Repeatable	Additional information about the Academic Program	Not Recommended	minOcc 0 maxOcc ∞ minLength 1 maxLength 80

Comment: The academic program is not normally included in a high school transcript, so this entire portion of the schema would not normally be included.

Code illustration:

```

<AcademicProgram>
  <ProgramCIPCode />
  <AcademicProgramType>Major</AcademicProgramType>
  <AcademicProgramName>General Transfer</AcademicProgramName>
  <NoteMessage />
</AcademicProgram>
    
```

Student.AcademicRecord.AcademicSummary

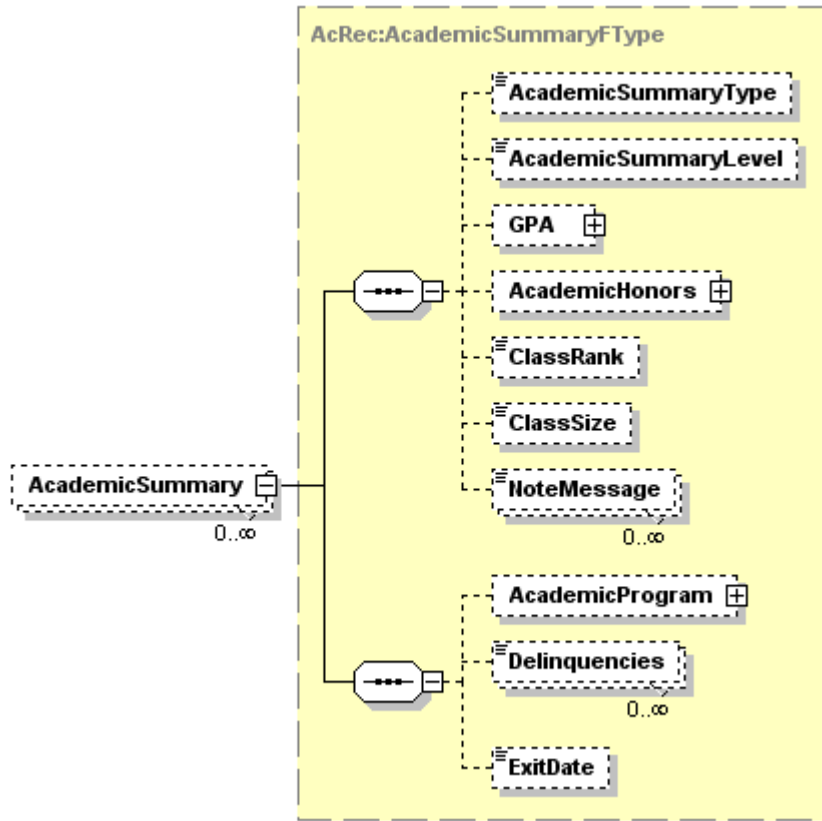

Tag Name	Schema Use	Description	Recommended Use	Format
AcademicSummaryType	Optional	<p>Summary Type is an indication of what is being summarized over what period of time</p> <p><i>All</i> - Summary of all courses regardless of institution</p> <p><i>SenderOnly</i> - Summary of all courses at sending institution (or recorded as if they were taken at the sending institution)</p> <p><i>TransferOnly</i> - Summary of transfer work (courses taken at other than the sending institution)</p> <p><i>AllNotRepeated</i> - Summary of all courses except for repeated or forgiven courses/credits</p> <p><i>SenderNotRepeated</i> - Summary of all courses at sending institution except for repeated or forgiven courses/credits</p> <p><i>TransferNotRepeated</i> - Summary of transfer work except for repeated or forgiven courses/credits</p> <p><i>AcademicRenewal</i> - Subset of forgiven courses</p> <p><i>CarryoverCredit</i> - Summary from offline records and used as the initial point for cumulatives and averages</p> <p><i>DegreeApplicable</i> - Summary of courses that apply to degree</p>	Recommended	<p>minOcc 0</p> <p>maxOcc 1</p> <p>Enumerations:</p> <ul style="list-style-type: none"> All SenderOnly TransferOnly AllNotRepeated SenderNotRepeated TransferNotRepeated AcademicRenewal CarryoverCredit DegreeApplicable NonDegreeApplicable ConvertedFrom ConvertedTo UserDefined Weighted NonWeighted

Tag Name	Schema Use	Description	Recommended Use	Format
		<p><i>NonDegreeApplicable</i> - Summary of courses that do not apply toward degree</p> <p><i>ConvertedFrom</i> - Summary of credits before an institutional term-basis conversion, such as from quarters to semesters</p> <p><i>ConvertedTo</i> - Summary of credits after an institutional term-basis conversion, such as from quarters to semesters</p> <p><i>Weighted</i> – Summary that gives additional (higher) value to specific courses taken by a student, such as honors courses, International Baccalaureate, Advanced Placement, high school/college dual enrollment.</p> <p><i>NonWeighted</i> – Summary that does not give additional value to courses, regardless of special characteristics of the courses. For example, if the grading scale is from 0 to 4.00, then it is not possible to have a summary higher than 4.00.</p> <p><i>UserDefined</i> - Use NoteMessage for explanation</p>		
AcademicSummaryLevel	Optional	The level of credit associated with the credit hours earned for the course.	Not Recommended	minOcc 0 maxOcc 1 Enumerations: Undergraduate LowerDivision UpperDivision Vocational TechnicalPreparatory Graduate Professional Dual GraduateProfessional
Comment: The enumerated values do not seem to be appropriate for the high school transcript.				
GPA	Optional	GPA for this Academic Summary	Recommended	minOcc 0 maxOcc 1
Comment: This complex data element will be expanded on page XXX which follows.				
AcademicHonors	Optional	Academic Honors for this Academic Summary	Optional	minOcc 0 maxOcc 1
Comment: This complex data element will be expanded on page XXX which follows.				
ClassRank	Optional	The student's class rank relative to other students in their academic cohort (e.g. class).	Recommended	minOcc 0 maxOcc 1 minInclusive 1 maxInclusive 9999 totalDigits 4
Comment: The Workgroup that developed the PESC XML High School Transcript Schema recommends that this is the most appropriate place in the Schema to include the student's overall rank in class. The student ranking the highest in the class would have a rank of "1".				
ClassSize	Optional	The numeric size of the academic cohort (e.g. class).	Recommended	minOcc 0 maxOcc 1 minInclusive 1 maxInclusive 9999 totalDigits 4
Comment: If there were 753 students in the student's class and they were ranked by the high school, then this value would be "753".				

Tag Name	Schema Use	Description	Recommended Use	Format
NoteMessage	Optional Repeatable	Additional information about the Academic Summary	Optional	minOcc 0 maxOcc ∞ minLength 1 maxLength 80
Comment: If the class rank and class size are included in the transcript, then this note message could be used to indicate the cohort and/or date of the ranking.				
AcademicProgram	Optional	Academic Program (e.g. major) for this Academic Summary	Optional	minOcc 0 maxOcc 1
Comment: This is the appropriate place to list the student's current major or degree objective. However, this information is not normally included in a high school transcript. This complex data element will be expanded on page XXX which follows.				
Delinquencies	Optional Repeatable	The academic standing of the student upon transfer to the institution. <i>GoodStanding</i> - Student was in good standing <i>ProbationGPA</i> - Student was on academic probation (because of low GPA) <i>ProbationHours</i> - Student was on academic probation (deficiency in credit hours) <i>SuspensionGPA</i> - Student was on academic suspension (because of low GPA) <i>SuspensionHours</i> - Student was on academic suspension (deficiency in credit hours) <i>ProbationDiscipline</i> - Student was on disciplinary probation <i>SuspensionDiscipline</i> - Student was on disciplinary suspension <i>Unknown</i> <i>Other</i>	Not Recommended	minOcc 0 maxOcc ∞ Enumerations: GoodStanding ProbationGPA ProbationHours SuspensionGPA SuspensionHours ProbationDiscipline SuspensionDiscipline Unknown Other
Comment: It is recommended that probation not be included on the transcript since there is no universally accepted definition of probation, and that other Delinquencies be included at the Session level.				
ExitDate	Optional	The date on which the student officially withdrew or graduated	Not Recommended	minOcc 0 maxOcc 1 xs:decimal
Comment: This date would typically be the date of graduation for students who did graduate. If the student did not graduate, it would be the last date of known attendance. The date format is ccyy-mm-dd.				
Comment: This portion of the XML High School Transcript is the place for the overall summary of the student's entire high school academic record.				

Code illustration:

```

<AcademicSummary>
  <AcademicSummaryType>All</AcademicSummaryType>
  <AcademicSummaryLevel I/>
  <GPA>

  </GPA>
  <AcademicHonors>

  </AcademicHonors>
  <ClassRank>1</ClassRank>
  <ClassSize>753</ClassSize>
  <NoteMessage>Class ranking was of all seniors at the end of the seventh semester.</NoteMessage>
  <AcademicProgram>

  </AcademicProgram>
  <Delinquencies />
  <ExitDate />
</AcademicSummary>
    
```

Student.AcademicRecord.AcademicSummary.GPA

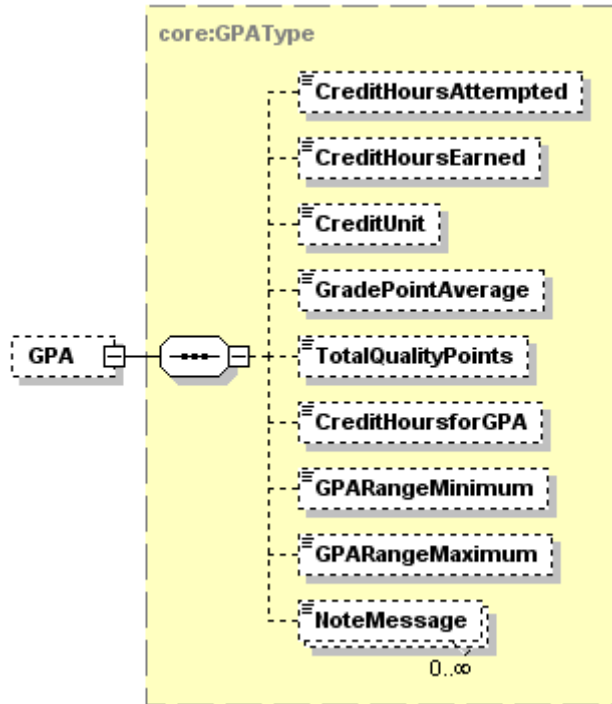

Tag Name	Schema Use	Description	Recommended Use	Format
CreditHoursAttempted	Optional	The total value of credit hours attempted whether or not included in the hours for GPA or hours earned	Recommended	minOcc 0 maxOcc 1 xs:decimal
<p>Comment: This would also include the credit value of a course from which the student withdrew, if it appears on the transcript. So if a student had enrolled in 10 Carnegie Units which are all included in the specified program and appear on the transcript, and had passed five units and withdrawn from 5 units, then the value of this field would be "10". If the student had enrolled for 10.5 units that are included on the transcript, then the value of this field would be "10.5".</p>				
CreditHoursEarned	Optional	The total value of credit hours successfully completed or earned	Recommended	minOcc 0 maxOcc 1 xs:decimal
<p>Comment: If the student had earned 5 Carnegie Units and they all are included on the transcript, then the value of this data element would be "5". If only 4.5 units were earned, then the value would be "4.5".</p>				
CreditUnit	Optional	The type of credit (unit, semester, or quarter) associated with the credit hours earned for the course	Recommended	minOcc 0 maxOcc 1 Enumerations: NoCredit Quarter Semester Units ClockHours CarnegieUnits ContinuingEducationUnits Unreported Other
<p>Comment: Note that the credit unit is not necessarily directly related to the type of session in which a course is offered. A full year course, or a semester course, or a quarter course, may all offer Carnegie Units or Units as the credit unit.</p>				

Tag Name	Schema Use	Description	Recommended Use	Format
GradePointAverage	Optional	The value of the total quality points divided by the Credit Hours for Grade Point Average	Recommended	minOcc 0 maxOcc 1 xs:decimal
Comment: For example, if the student had enrolled for 10 Carnegie Units, passed 8 units with grades of B worth 3 grade points for each Carnegie Unit, and 2 Carnegie Units with grades of F worth 0 grade points, then the calculation would be 24 grade points divided by 10 or a GPA of "2.4" or "2.40" or "2.400" depending on the policy of the sending school.				
TotalQualityPoints	Optional	The total value of quality points used for the calculation of the Grade Point Average	Recommended	minOcc 0 maxOcc 1 xs:decimal
Comment: If a student earned all grades of B (worth 3 grade points for each Carnegie Unit) in 8.5 Carnegie Units that count toward this diploma and this program, then the value of this data element would be "25.5".				
CreditHoursforGPA	Optional	The total value of credit hours used to calculate the Grade Point Average	Recommended	minOcc 0 maxOcc 1 xs:decimal
Comment: If a student earned grades of A (worth 4 grades points per unit) in 3 Carnegie Units, grades of F (worth 0 points per unit) in 4 units; and withdrew from 5 units, then the total credit hours for GPA would be "7".				
GPARangeMinimum	Optional	The minimum possible Grade Point Average	Recommended	minOcc 0 maxOcc 1 xs:decimal
Comment: If the lowest possible grade is an F and a grade of F is valued at 0 grade points, then this value would be "0", or "0.0" or "0.00".				
GPARangeMaximum	Optional	The maximum possible Grade Point Average	Recommended	minOcc 0 maxOcc 1 xs:decimal
Comment: If the highest possible grade is an A and a grade of A is valued at 4 grade points, then this value would be "4" or "4.0" or "4.00", etc.				
NoteMessage	Optional Repeatable	Additional information about the GPA	Not Recommended	minOcc 0 maxOcc ∞ minLength 1 maxLength 80
Comment: The GPA included at this point in the Schema represents the overall GPA for the student's entire record included on the transcript.				

Code illustration:

```

<GPA>
  <CreditHoursAttempted>10.5</CreditHoursAttempted>
  <CreditHoursEarned>6.5</CreditHoursEarned>
  <CreditUnit>CarnegieUnits</CreditUnit>
  <GradePointAverage>2.235</GradePointAverage>
  <TotalQualityPoints>19</TotalQualityPoints>
  <CreditHoursforGPA>8.5</CreditHoursforGPA>
  <GPARangeMinimum>0</GPARangeMinimum>
  <GPARangeMaximum>4</GPARangeMaximum>
  <NoteMessage />
</GPA>

```

Student.AcademicRecord.AcademicSummary.AcademicHonors

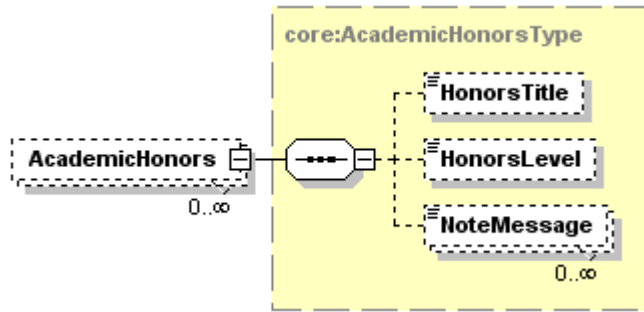

Tag Name	Schema Use	Description	Recommended Use	Format
HonorsTitle	Optional	The descriptive title for the honors received	Recommended	minOcc 0 maxOcc 1 minLength 1 maxLength 30
Comment: There is a variety of names for these honors in the United States. Some common ones are “Valdictorian”, “Salutatorian”, “With Honors”, “Magna Cum Laude”, etc.				
HonorsLevel	Optional	A code value representing 1st highest honor, 2nd highest and 3rd highest	Recommended	minOcc 0 maxOcc 1 Enumeration: FirstHighest SecondHighest ThirdHighest
Comment: Honors Level is critical to understanding the context of Honors Title.				
NoteMessage	Optional Repeatable	Additional information about the Academic Honors	Not Recommended	minOcc 0 maxOcc ∞ minLength 1 maxLength 80
Comment: This would be one appropriate place in the Schema to include honors not specifically tied to the diploma awarded. Examples might be “AP Scholars”, “Sigma Alpha Tau”, etc.				

Code illustration:

```
<AcademicHonors>
  <HonorsTitle>Sigma Alpha Tau</HonorsTitle>
  <HonorsLevel>FirstHighest</HonorsLevel>
  <NoteMessage>For seniors earning a composite SAT score of 1,200 or higher</NoteMessage>
</AcademicHonors>
```

Student.AcademicRecord.AcademicSummary.AcademicProgram

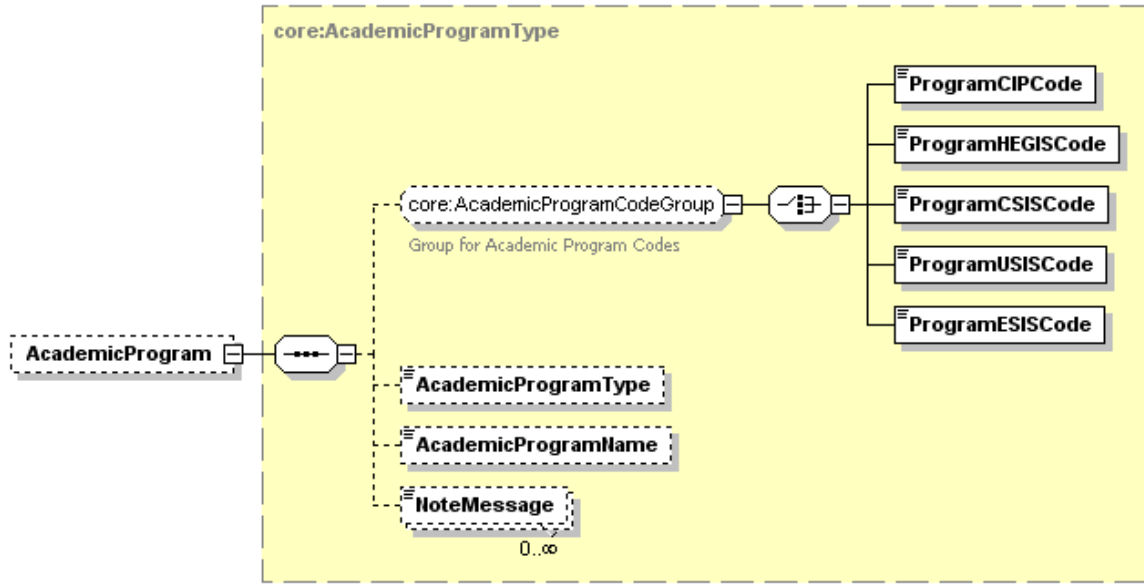

Tag Name	Schema Use	Description	Recommended Use	Format
ProgramCIPCode	Optional exclusive choice	Code indicating a discipline or field of study assigned by the Classification of Instructional Programs	Not Recommended	minOcc 0 maxOcc 1 minLength 6 maxLength 20
ProgramHEGISCode	Optional exclusive choice	Code indicating a discipline or field of study assigned by Higher Education General Information Survey	Not Recommended	minOcc 0 maxOcc 1 minLength 6 maxLength 20
ProgramCSISCode	Optional exclusive choice	Code indicating a discipline or field of study assigned by Statistics Canada Canadian College Student Information System	Not Recommended	minOcc 0 maxOcc 1 minLength 5 maxLength 5
ProgramUSISCode	Optional exclusive choice	Code indicating a discipline or field of study assigned by the Statistics Canada University Student Information System.	Not Recommended	minOcc 0 maxOcc 1 minLength 5 maxLength 5
ProgramESISCode	Optional exclusive choice	Code indicating a discipline or field of study assigned by the Statistics Canada Enhanced Student Information System.	Not Recommended	minOcc 0 maxOcc 1 minLength 1 maxLength 20
Comment: Although the Academic Program Code Group is optional, if it is included, then you must send one and only one of the above codes. None of the above code sets is appropriate to describe high school academic programs in the United States.				
AcademicProgramType	Optional	Indicates whether the academic program is a major, minor, area of concentration or specialization.	Recommended	minOcc 0 maxOcc 1 Enumerations: Concentration Major Minor Specialization
AcademicProgramName	Optional	Literal name of program, major, or field of study.	Recommended	minOcc 0 maxOcc 1 minLength 1 maxLength 60

Tag Name	Schema Use	Description	Recommended Use	Format
NoteMessage	Optional Repeatable	Additional information about the Academic Program	Not Recommended	minOcc 0 maxOcc ∞ minLength 1 maxLength 80

Comment: The academic program is not normally included in a high school transcript, so this entire portion of the schema would not be included for the high school transcript.

Code illustration:

```

<AcademicProgram>
  <ProgramCIPCode />
  <AcademicProgramType>Major</AcademicProgramType>
  <AcademicProgramName>General Academic Transfer Track</AcademicProgramName>
  <NoteMessage />
</AcademicProgram>
    
```

Student.AcademicRecord.AcademicSession

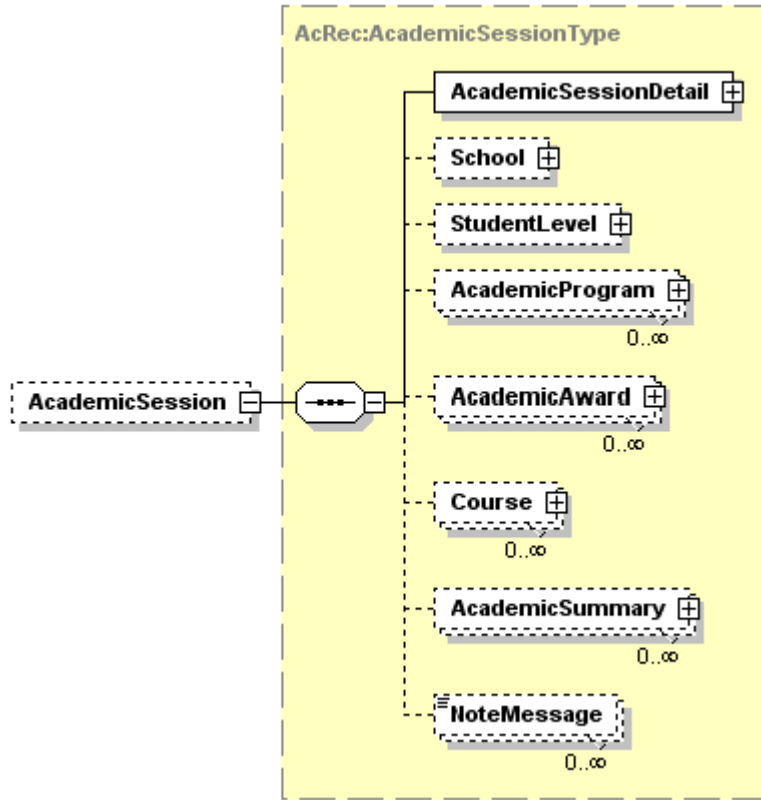

Tag Name	Schema Use	Description	Recommended Use	Format
AcademicSessionDetail	Required	Information identifying the time period for the beginning of this session	Required	minOcc 1 maxOcc 1
<p>Comment: The Session Designator within the Academic Session Detail is used to indicate the starting year and month of major academic terms or sessions within the sending school's calendar. For example, a typical fall term would begin in August or September. So, for a fall term that began in August of the year 2005, the value of this field would be "2005-08". All classes that began in this month and year would normally be included within this session designator, regardless of the ending dates of the classes within this session. Therefore, all classes with this same session designator would be included in the academic summary for this session. It is also possible for other courses that began later than the month and year noted here, might also have this same session designator, if they are generally considered to be within the academic session or term.</p> <p>This complex data element will be expanded on page XXX which follows.</p>				
School	Optional	Override School	Conditional	minOcc 0 maxOcc 1
<p>Comment: Recommended when the school for this AcademicSession differs from the Sending institution. Not Recommended when this AcademicSession belongs to the Sending institution. This complex data element will be expanded on page XXX which follows.</p>				
StudentLevel	Optional	An indication of the classification of the student at the time of this Academic Session	Optional	minOcc 0 maxOcc 1
<p>Comment: This complex data element will be expanded on page XXX which follows.</p>				

Tag Name	Schema Use	Description	Recommended Use	Format
AcademicProgram	Optional Repeatable	The major or degree objectives for the student at the time of this session	Optional	minOcc 0 maxOcc ∞
Comment: The academic program is not normally included in a high school transcript. This complex data element will be expanded on page XXX which follows.				
AcademicAward	Optional Repeatable	Academic awards associated with this session	Not Recommended	minOcc 0 maxOcc ∞
Comment: The developers of the PESC High School Transcript Schema recommend that the most appropriate place in the schema to indicate the award of the high school diploma is at the highest level of the schema, which is Student.AcademicRecord.AcademicAward. We recommend only awards that are earned as a result of this session only be included here. This complex data element will be expanded on page XXX which follows.				
Course	Optional Repeatable	Courses associated with this session	Recommended	minOcc 0 maxOcc ∞
Comment: This complex data element will be expanded on page XXX which follows.				
AcademicSummary	Optional Repeatable	Academic summary for this session	Optional	minOcc 0 maxOcc ∞
Comment: This complex data element will be expanded on page XXX which follows.				
NoteMessage	Optional Repeatable	Additional information about the academic session	Not Recommended	minOcc 0 maxOcc ∞ minLength 1 maxLength 80

Code illustration:

```

<AcademicSession>
  <AcademicSessionDetail>

  </AcademicSessionDetail>
  <School>

  </School>
  <StudentLevel>

  </StudentLevel>
  <AcademicProgram>

  </AcademicProgram>
  <AcademicAward>

  </AcademicAward>
  <Course>

  </Course>
  <Course>

  </Course> [repeat as needed]
  <AcademicSummary>

  </AcademicSummary>
  <NoteMessage />
</AcademicSession>
    
```

Student.AcademicRecord.AcademicSession.AcademicSessionDetail

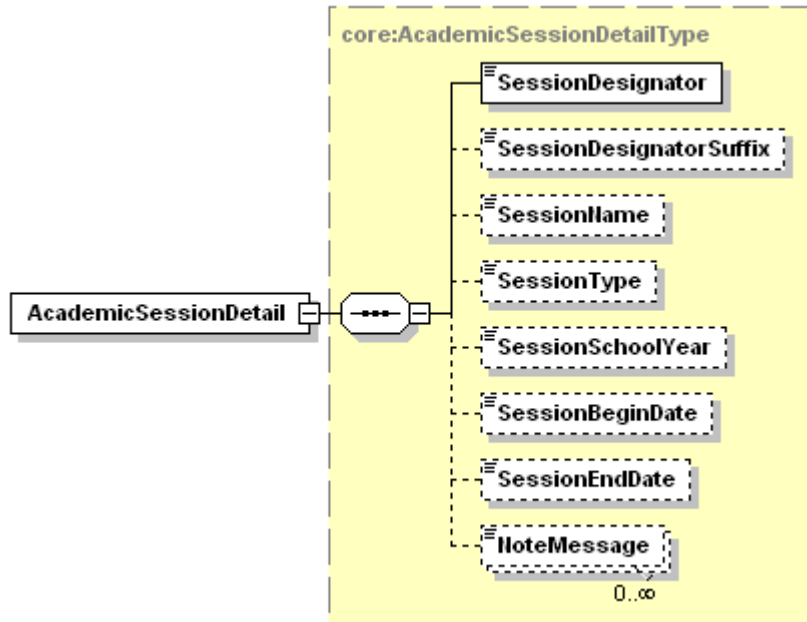

Tag Name	Schema Use	Description	Recommended Use	Format
SessionDesignator	Required	The academic session for which the data are recorded and applicable.	Required	minOcc 1 maxOcc 1 YearMonth (ccyy-mm)
<p>Comment: The Session Designator is used to indicate the starting year and month of major academic terms within the sending school's calendar. For example, a typical fall term would begin in August or September. So, for a fall term that began in August of the year 2005, the value of this field would be "2005-08". All classes that began in this month and year would normally be included within this session designator, regardless of the ending dates of the classes within this session. Therefore, all classes with this same session designator would be included in the academic summary for this session. It is also possible for other courses that began later than the month and year noted here, might also have this same session designator, if they are generally considered to be within the academic session or term.</p>				
SessionDesignatorSuffix	Optional	A free form extension to the session ID to differentiate discreet sub-sessions within the same session	Optional	minOcc 0 maxOcc 1 minLength 1 maxLength 10
<p>Comment: If you have a mini term or short term within the major term, you can use this field to identify those classes. They could be identified with different beginning or ending dates, but they would still be a part of the major session designator. Typical Entries in this field might be "Mini Term", "Term A", "Term B", "Session 1". It would probably be unusual for a high school to include this field.</p>				
SessionName	Optional	Free-form name of session.	Recommended	minOcc 0 maxOcc 1 minLength 1 maxLength 30
<p>Comment: For example, "Fall Semester 2002" or "Fall Semester 2003" or "Fall Semester 2002-2003".</p>				

Tag Name	Schema Use	Description	Recommended Use	Format
SessionType	Optional	Indicates the type of academic session at an educational institution.	Recommended	minOcc 0 maxOcc 1 Enumerations: FullYear Semester Trimester Quarter Quinmester MiniTerm SummerSession Interession LongSession FallSession FourOneFourPlan Continuous DiffersByProgram Other TwelveMonth
Comment: This is the type of calendar used by the sending school. It does not refer to the type of units of credit awarded.				
SessionSchoolYear	Optional	This is the range of years that are considered to be a school year.	Optional	minOcc 0 maxOcc 1 xs:date
Comment: The appropriate values are a range of years. The format would be cyyy-cyy. A typical example would be the school year "2004-2005".				
SessionBeginDate	Optional	Actual calendar date when session begins.	Optional	minOcc 0 maxOcc 1 xs:date
Comment: An example for a fall term might be "2005-08-22". The date format is cyyy-mm-dd.				
SessionEndDate	Optional	Actual calendar date when session ends.	Optional	minOcc 0 maxOcc 1 xs:date
Comment: An example for a fall term might be "2005-12-16" or "2006-01-18".				
NoteMessage	Optional Repeatable	Additional information about the Academic Session	Not Recommended	minOcc 0 maxOcc ∞ minLength 1 maxLength 80

Code illustration:

```

<AcademicSessionDetail>
  <SessionDesignator>2005-08</SessionDesignator>
  <SessionDesignatorSuffix>1</SessionDesignatorSuffix>
  <SessionName>Fall Semester 2005</SessionName>
  <SessionType>Semester</SessionType>
  <SessionBeginDate>2005-08-22</SessionBeginDate>
  <SessionEndDate>2005-12-16</SessionEndDate>
  <NoteMessage />
</AcademicSessionDetail>
    
```

Student.AcademicRecord. AcademicSession.School

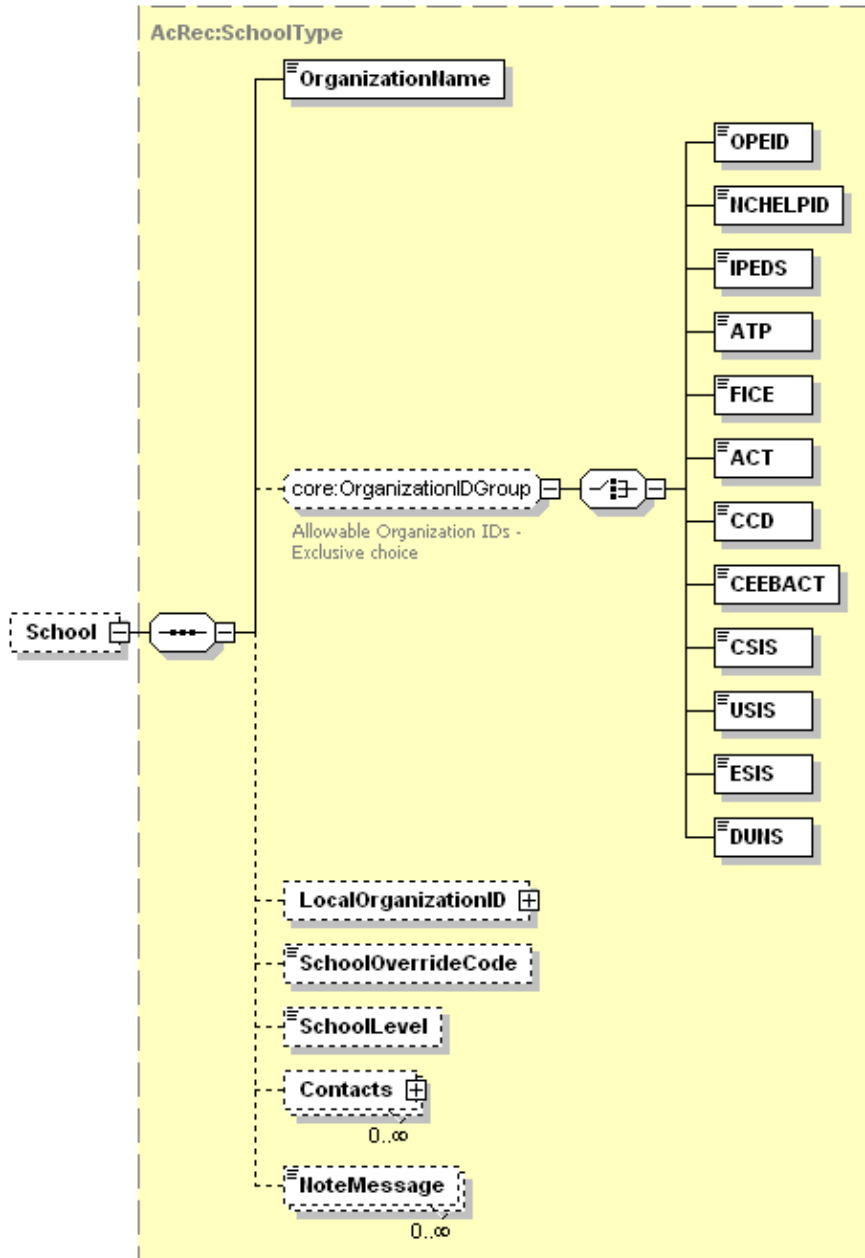

Tag Name	Schema Use	Description	Recommended Use	Format
OrganizationName	Required	Name of Override School	Required	minOcc 1 maxOcc 1 minLength 1 maxLength 60
OPEID	Required choice	The unique identifier assigned by the Office of Postsecondary Education for each data exchange partner.	Recommended (use one)	minOcc 0 maxOcc 1 minLength 3 maxLength 8

Comment: The OPEID would only be an appropriate choice if the courses taken in this session were taken at a postsecondary institution.

Tag Name	Schema Use	Description	Recommended Use	Format
NCHELPID	Required choice	The unique identifier assigned by National Council on Higher Education Loan Programs for each data exchange partner.	Not Recommended	minOcc 0 maxOcc 1 minLength 3 maxLength 8
Comment: The NCHELPID is not an appropriate code set for the High School Transcript				
IPEDS	Required choice	The unique identifier assigned by the National Center for Education Statistics for the Integrated Postsecondary Education Data System for each postsecondary data exchange partner.	Recommended (use one)	minOcc 0 maxOcc 1 minLength 6 maxLength 6
Comment: The IPEDS would only be an appropriate choice if the courses taken in this session were taken at a postsecondary institution.				
ATP	Required choice	The unique identifier assigned for the Admissions Testing Program by the College Board for each postsecondary data exchange partner.	Recommended (use one)	minOcc 0 maxOcc 1 minLength 6 maxLength 6
Comment: The ATP would only be an appropriate choice if the courses taken in this session were taken at a postsecondary institution.				
FICE	Required choice	The unique identifier assigned for the Federal Interagency Committee on Education by the US Department of Education's National Center for Education Statistics for each postsecondary data exchange partner	Recommended (use one)	minOcc 0 maxOcc 1 minLength 6 maxLength 6
Comment: The FICE would only be an appropriate choice if the courses taken in this session were taken at a postsecondary institution.				
ACT	Required choice	The unique identifier assigned by the American College Testing or ACT for each postsecondary data exchange partner. See www.act.org.	Not Recommended	minOcc 0 maxOcc 1 minLength 4 maxLength 4
Comment: The ACT would only be an appropriate choice if the courses taken in this session were taken at a postsecondary institution.				
CCD	Required choice	The unique identifier assigned by the US Department of Education's National Center for Education Statistics as the Common Core of Data for each K12 data exchange partner.	Recommended (use one)	minOcc 0 maxOcc 1 minLength 12 maxLength 12
Comment: The CCD would be an appropriate choice if the courses taken in this session were taken at another secondary school.				
CEEBACT	Required choice	The unique identifier assigned by the College Entrance Examining Board and ACT for each data exchange partner.	Recommended (use one)	minOcc 0 maxOcc 1 minLength 6 maxLength 6
Comment: The CEEBACT would be an appropriate choice if the courses taken in this session were taken at another secondary institution.				
CSIS	Required choice	The unique identifier assigned by the Statistics Canada Canadian College Student Information System for each data exchange partner in Canada	Recommended (use one)	minOcc 0 maxOcc 1 minLength 6 maxLength 6
Comment: The CSIS would only be an appropriate choice if the courses taken in this session were taken at a Canadian institution.				

Tag Name	Schema Use	Description	Recommended Use	Format
USIS	Required choice	The unique identifier assigned by the Statistics Canada University Student Information System for each data exchange partner in Canada	Recommended (use one)	minOcc 0 maxOcc 1 minLength 6 maxLength 6
Comment: The USIS would only be an appropriate choice if the courses taken in this session were taken at a Canadian institution.				
ESIS	Required choice	The unique identifier assigned by the Statistics Canada Enhanced Student Information System for each data exchange partner.in Canada	Recommended (use one)	minOcc 0 maxOcc 1 minLength 8 maxLength 8
Comment: The ESIS would only be an appropriate choice if the courses taken in this session were taken at a Canadian institution.				
DUNS	Required choice	Data Universal Numbering System (DUNS), unique nine character company identification number issued by Dun and Bradstreet Corporation.	Not Recommended	minOcc 0 maxOcc 1 minLength 9 maxLength 9
Comment: The DUNS number would not be an appropriate code set to use to identify the school at which high school or postsecondary school courses were taken.				
LocalOrganizationID	Optional	A code set typically used by a state, province or region to further identify the receiving school or agency	Optional	minOcc 0 maxOcc 1
Comment: This complex data element will be expanded on page XXX which follows.				
SchoolOverrideCode	Optional	The source of the academic credit if not awarded by the home or parent institution. Institutional - Institutional Agreement Multicampus - Multiple Campus Course Offering Transfer - Transfer Credit StudyAbroad - Study Abroad Coop - Cooperative Program Reciprocal - Reciprocal Exchange Internship - Internship	Recommended	minOcc 0 maxOcc 1 Enumerations: Institutional Multicampus Transfer StudyAbroad Coop Reciprocal Internship
SchoolLevel	Optional	Indicates level of Override School	Recommended	minOcc 0 maxOcc 1 Enumerations: Elementary Secondary Postsecondary
Contacts	Optional Repeatable	Contact info at Override School	Optional	minOcc 0 maxOcc ∞
Comment: This complex data element will be expanded on page XXX which follows.				
NoteMessage	Optional Repeatable	Additional information about the Override School	Not Recommended	minOcc 0 maxOcc ∞ minLength 1 maxLength 80
Comment: This entire section of the Schema would only be included if the courses taken during this session were taken at a school other than the sending school.				

Code illustration:

```
<School>  
  <OrganizationName>New Trier Township High School</OrganizationName>  
  <CEEBACT>144430</CEEBACT>  
  <SchoolOverrideCode>Transfer</SchoolOverrideCode>  
  <SchoolLevel>Secondary</SchoolLevel>  
  <Contacts>  
  
    </Contacts>  
  <NoteMessage />  
</School>
```

Student.AcademicRecord.AcademicSession.School.LocalOrganizationID

Note: Although the complex data element LocalOrganizationID is an optional data element, if you choose to send LocalOrganizationID, then you must also send both LocalOrganizationIDCode and also LocalOrganizationIDQualifier.

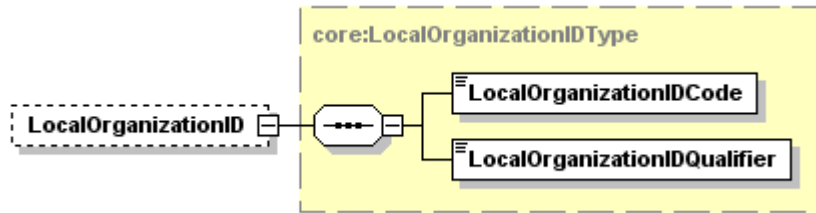

Tag Name	Schema Use	Description	Recommended Use	Format
LocalOrganizationIDCode	Required	The code assigned for the receiving school by the state, province or other mutually defined agency specified in the LocalOrganizationIDQualifier that follows.	Required	minOcc 1 maxOcc 1 minLength 1 maxLength 35
<p>Comment: This is a required data element only if the LocalOrganization ID data element is sent. This is typically the administrative school code assigned by a state or province to specifically identify the receiving school in that state. If it is not assigned by a state or province, then code ZZ should be used in the Local ID Qualifier that follows.</p>				
LocalOrganizationIDQualifier	Required	This is the state, province or other mutually defined agency that assigned the Local ID Code above.	Required	minOcc 1 maxOcc 1 See Code Set in Appendix A
<p>Comment: This is a required data element only if the Local Organization ID data element is sent. This is typically the state or province that assigned the code to specifically identify the receiving school in that state. If it is not assigned by a state or province, then code ZZ should be used in this data element</p>				

Code illustration:

```
<LocalOrganizationID>
  <LocalOrganizationIDCode>GA-430000356</LocalOrganizationIDCode>
  <LocalOrganizationIDQualifier>GA</LocalOrganizationIDQualifier>
</LocalOrganizationID>
```

Student.AcademicRecord. AcademicSession.School.Contacts

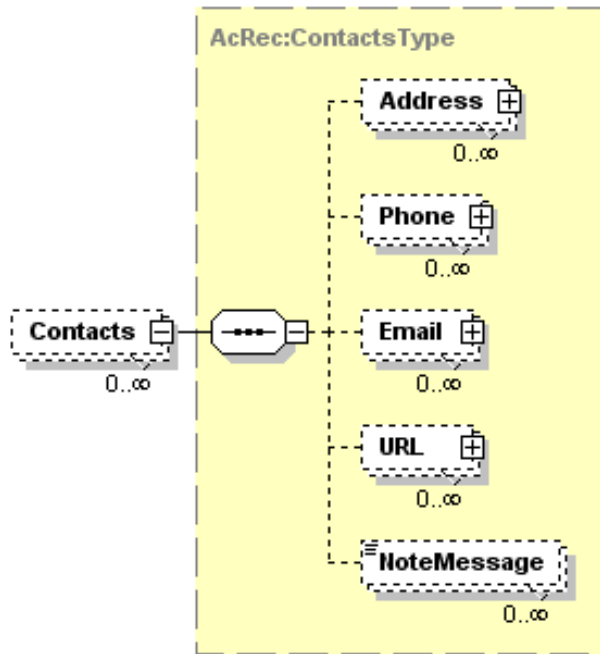

Tag Name	Schema Use	Description	Recommended Use	Format
Address	Optional Repeatable	Address of the Override School	Recommended	minOcc 0 maxOcc ∞
Comment: This complex data element will be expanded on page XXX which follows.				
Phone	Optional Repeatable	Phone Number of the Override School	Optional	minOcc 0 maxOcc ∞
Comment: This complex data element will be expanded on page XXX which follows.				
Email	Optional Repeatable	Email Address of the Override School	Optional	minOcc 0 maxOcc ∞
Comment: This complex data element will be expanded on page XXX which follows.				
URL	Optional Repeatable	Universal Resource Locator of the Override School	Optional	minOcc 0 maxOcc ∞
Comment: This complex data element will be expanded on page XXX which follows.				
NoteMessage	Optional Repeatable	Additional information about the contacts at the Override School	Not Recommended	minOcc 0 maxOcc ∞ minLength 1 maxLength 80

Student.AcademicRecord. AcademicSession.School.Contacts (Continued)

Code illustration:

```
<Contacts>  
  <Address>  
  
    </Address>  
    <Phone>  
  
    </Phone>  
    <Email>  
  
    </Email>  
    <URL>  
  
    </URL>  
    <NoteMessage />  
</Contacts>
```

Student.AcademicRecord.AcademicSession.School.Contacts.Address

Note: Although the complex data element Address is an optional data element, if you choose to send the Address of the Override School in the Academic Session, then you must send AddressLine and City and also StateProvinceCode and PostalCode OR CountryCode.

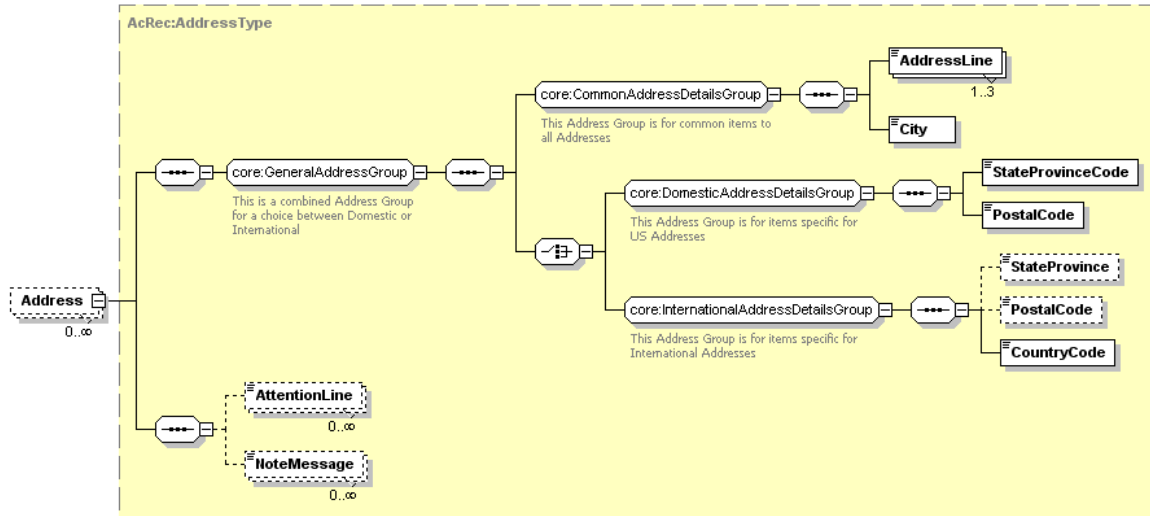

Tag Name	Schema Use	Description	Recommended Use	Format
<i>GeneralAddressGroup</i>	Required	This Address Group is for items common to all Addresses	Required	minOcc 1 maxOcc 1
Comment: [<i>GeneralAddressGroup</i>] does not appear in the instance document. It requires the use of <i>CommonAddressDetailsGroup</i> and the choice of one of either <i>DomesticAddressDetailsGroup</i> or <i>InternationalAddressDetailsGroup</i> . This group is required in the schema only if you choose to send the address of the contact.				
<i>CommonAddressDetailsGroup</i>	Required	This Address Group is for items common to all Addresses	Required	minOcc 1 maxOcc 1
Comment: [<i>CommonAddressDetailsGroup</i>] does not appear in the instance document. If the address of a contact is included in the transcript, then this must be sent. It is required and must be paired with one of either <i>DomesticAddressDetailsGroup</i> or <i>InternationalAddressDetailsGroup</i> .				
<i>AddressLine</i>	Required Repeatable	Local delivery information such as street, building number, PO box, or apartment portion of a postal address of a Contact at the Sending (Source) High School.	Required	minOcc 1 maxOcc 3 minLength 1 maxLength 40
<i>City</i>	Required	The city portion of the Address of a Contact at the Sending (Source) High School.	Required	minOcc 1 maxOcc 1 minLength 2 maxLength 30
<i>DomesticAddressDetailsGroup</i>	Required choice	This Address Group is for items specific for US and Canadian Addresses	Required for domestic addresses	minOcc 1 maxOcc 1
Comment: [<i>DomesticAddressDetailsGroup</i>] does not appear in the instance document. If the complex data element address has a United States or Canadian Postal Code and a US State or Canadian Province Code, then this should be the required choice.				

Tag Name	Schema Use	Description	Recommended Use	Format
StateProvinceCode	Required	Code for US states, etc., and Canadian provinces.	Required	minOcc 1 maxOcc 1 Enumerations: See Appendix A
PostalCode	Required	The postal code portion of the Address.	Required	minOcc 1 maxOcc 1 minLength 1 maxLength 17
<i>InternationalAddressDetailsGroup</i>	Required choice	This Address Group is for items specific for International Addresses	Required for international addresses	minOcc 1 maxOcc 1
Comment: [InternationalAddressDetailsGroup] does not appear in the instance document. This choice is for addresses that do not have a US or Canadian postal code.				
StateProvince	Optional	The literal name of the state, province or territory of a postal address of the source of this document. Use for addresses outside US or Canada.	Recommended Refer to common postal practices of the source country	minOcc 0 maxOcc 1 minLength 2 maxLength 30
Comment: For an internet resource of states or other geographical subdivisions in countries other than the US and Canada, you might choose to refer to the website of the Universal Postal Union at http://www.upu.int				
PostalCode	Optional	The postal code portion of the Address.	Recommended Refer to common postal practices of the source country	minOcc 0 maxOcc 1 minLength 1 maxLength 17
Comment: For an internet resource of states or other geographical subdivisions in countries other than the US and Canada, you might choose to refer to the website of the Universal Postal Union at http://www.upu.int				
CountryCode	Required	Code indicating Country. Use ISO 3166-1 alpha-2 standard.	Required	minOcc 1 maxOcc 1 Enumerations: See Appendix B
AttentionLine	Optional	The individual or office name within the postal address where inquiries should be directed.	Optional	minOcc 0 maxOcc ∞ minLength 1 maxLength 45
Comment: This might be used to indicate where questions about the record should be sent. For example, <i>Principal, Guidance Counselor, Headmaster, etc.</i>				
NoteMessage	Optional Repeatable	Additional information about the addresses of the contacts at the source school	Not recommended	minOcc 0 maxOcc ∞ minLength 1 maxLength 80

Code illustration 1 (Domestic Address):

```

<Address>
  <AddressLine>1715 W Cesar Chavez</AddressLine>
  <City>Austin</City>
  <StateProvinceCode>TX</StateProvinceCode>
  <PostalCode>78703</PostalCode>
  <AttentionLine>Jane Doe</AttentionLine>
    <AttentionLine>Guidance Counselor</AttentionLine>
  <NoteMessage />
</Address>
    
```

**Student.AcademicRecord.AcademicSession.School.Contacts.Address
(Continued)**

Code illustration 2 (International Address):

```
<Address>  
  <AddressLine>Altova Corporation</AddressLine>  
  <AddressLine>Rudolfsplatz 13a/9</AddressLine>  
  <City>Wien</City>  
  <StateProvince />  
  <PostalCode>A-1010</PostalCode>  
  <CountryCode>AT</CountryCode>  
</Address>
```

Student.AcademicRecord.AcademicSession.School.Contacts.Phone

Note: Although Phone is an optional complex data element, if it is included, then the data element PhoneNumber must be included.

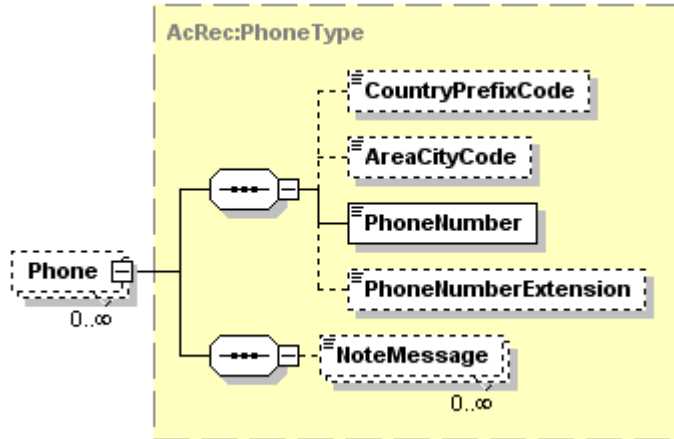

Tag Name	Schema Use	Description	Recommended Use	Format
CountryPrefixCode	Optional	International dialing code.	Optional	minOcc 0 maxOcc 1 minLength 1 maxLength 3
Comment: For example, the international dialing code for phone numbers in the US is "1". These codes are typically found in the information pages in the front of a telephone directory for a city or area.				
AreaCityCode	Optional	Regional dialing code.	Recommended	minOcc 0 maxOcc 1 minLength 1 maxLength 5
PhoneNumber	Required	Telephone number.	Required	minOcc 1 maxOcc 1 minLength 1 maxLength 11
Comment: If the phone data element is sent, then the phone number must be sent. It should be sent as a string of numbers with no spaces, periods or dashes.				
PhoneNumberExtension	Optional	The extended telephone addressing information used in addition to phone number such as a PBX extension, a pager PIN, or FAX sub-address.	Optional	minOcc 0 maxOcc 1 minLength 1 maxLength 5
NoteMessage	Optional Repeatable	Additional information about the phone number	Not recommended	minOcc 0 maxOcc ∞ minLength 1 maxLength 80

Code illustration:

```
<Phone>
  <CountryPrefixCode />
  <AreaCityCode>512</AreaCityCode>
  <PhoneNumber>4757638</PhoneNumber>
  <PhoneNumberExtension>3356</PhoneNumberExtension>
  <NoteMessage />
</Phone>
```

Student.AcademicRecord.AcademicSession.School.Contacts.Email

Note: Although Email is an optional complex data element, if it is included, then the data element EmailAddress must be included.

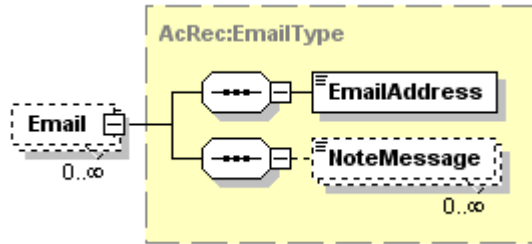

Tag Name	Schema Use	Description	Recommended Use	Format
EmailAddress	Required	The numbers, letters, and symbols used to identify an electronic mail (Email) user within a network.	Required	minOcc 1 maxOcc 1 minLength 1 maxLength 128
NoteMessage	Optional Repeatable	Additional information about the email address	Not recommended	minOcc 0 maxOcc ∞ minLength 1 maxLength 80
Comment: This is the email address for a contact at the override school.				

Code illustration:

```
<Email>
  <EmailAddress>stewartj@aol.com</EmailAddress>
  <NoteMessage />
</Email>
```

Student.AcademicRecord.AcademicSession.School.Contacts.URL

Note: Although URL is an optional complex data element, if it is included, then the data element URLAddress must be included.

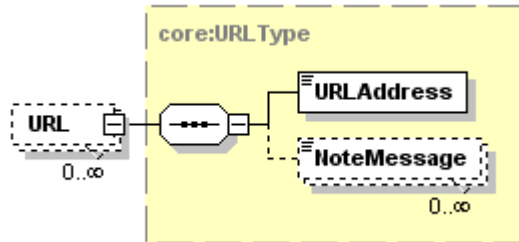

Tag Name	Schema Use	Description	Recommended Use	Format
URLAddress	Required	The Uniform Resource Locator (URL) address associated with a product, deliverable or contact.	Required	minOcc 1 maxOcc 1 minLength 0 maxLength 512
NoteMessage	Optional Repeatable	Additional information about the URL	Not Recommended	minOcc 0 maxOcc ∞ minLength 1 maxLength 80
Comment: This is the URL of the override school.				

Code illustration:

```
<URL>
  <URLAddress>www.NatickHighSchool.edu</URLAddress>
  <NoteMessage />
</URL>
```

Student.AcademicRecord.AcademicSession.StudentLevel

Note: Although StudentLevel is an optional complex data element, if it is included, then the data element StudentLevelCode must be included.

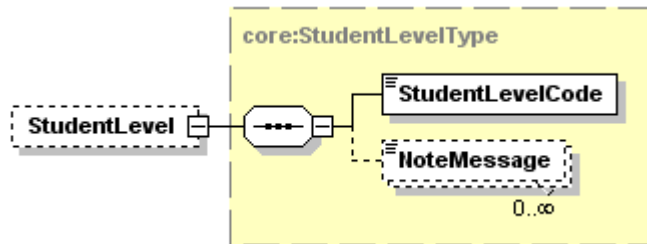

Tag Name	Schema Use	Description	Recommended Use	Format
StudentLevelCode	Required	The student's grade level or academic classification at the start of this academic session	Required	minOcc 1 maxOcc 1 Enumerations: SeventhGrade EighthGrade NinthGrade TenthGrade EleventhGrade TwelfthGrade
NoteMessage	Optional Repeatable	Additional information about the student level	Not Recommended	minOcc 0 maxOcc ∞ minLength 1 maxLength 80

Code illustration:

```

<StudentLevel>
  <StudentLevelCode>EighthGrade</StudentLevelCode>
  <NoteMessage />
</StudentLevel>
    
```

Student.AcademicRecord.AcademicSession.AcademicProgram

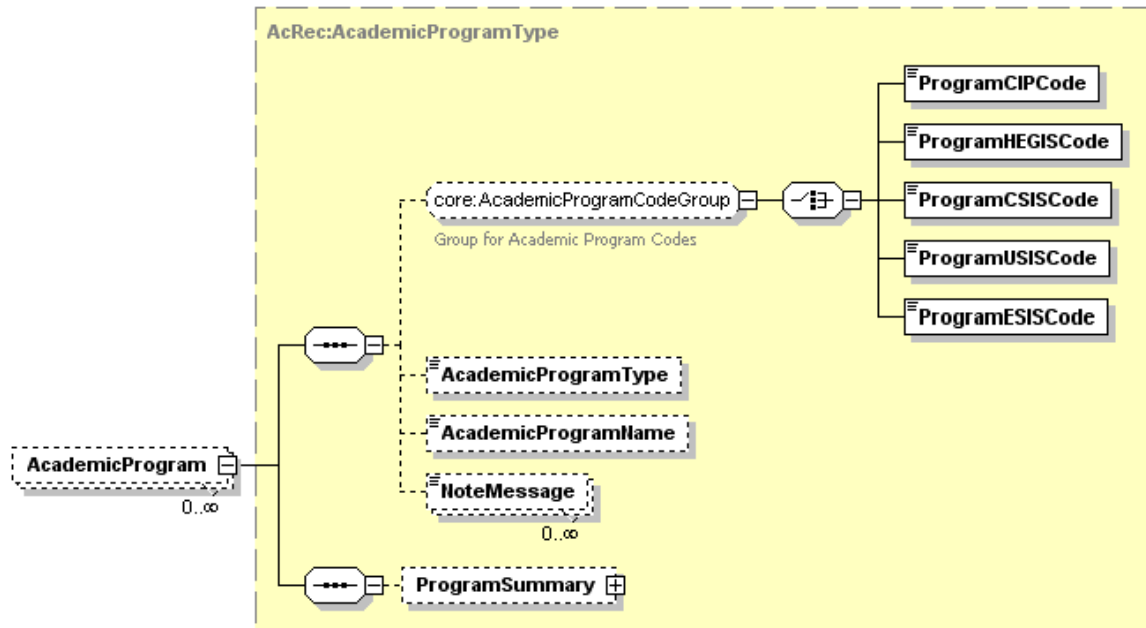

Tag Name	Schema Use	Description	Recommended Use	Format
ProgramCIPCode	Optional exclusive choice	Code indicating a discipline or field of study assigned by the Classification of Instructional Programs	Not Recommended	minOcc 0 maxOcc 1 minLength 6 maxLength 20
ProgramHEGISCode	Optional exclusive choice	Code indicating a discipline or field of study assigned by Higher Education General Information Survey	Not Recommended	minOcc 0 maxOcc 1 minLength 6 maxLength 20
ProgramCSISCode	Optional exclusive choice	Code indicating a discipline or field of study assigned by Statistics Canada Canadian College Student Information System	Not Recommended	minOcc 0 maxOcc 1 minLength 5 maxLength 5
ProgramUSISCode	Optional exclusive choice	Code indicating a discipline or field of study assigned by the Statistics Canada University Student Information System.	Not Recommended	minOcc 0 maxOcc 1 minLength 5 maxLength 5
ProgramESISCode	Optional exclusive choice	Code indicating a discipline or field of study assigned by the Statistics Canada Enhanced Student Information System.	Not Recommended	minOcc 0 maxOcc 1 minLength 1 maxLength 20
Comment: Although the entire Academic Program Code Group is optional, there are no appropriate code sets included for high school programs in the US.				
AcademicProgramType	Optional	Indicates whether the academic program is a major, minor, area of concentration or specialization.	Recommended	minOcc 0 maxOcc 1 Enumerations: Concentration Major Minor Specialization
AcademicProgramName	Optional	Literal name of program, major, or field of study.	Recommended	minOcc 0 maxOcc 1 minLength 1 maxLength 60

Tag Name	Schema Use	Description	Recommended Use	Format
NoteMessage	Optional Repeatable	Additional information about the academic program	Not Recommended	minOcc 0 maxOcc ∞ minLength 1 maxLength 80
ProgramSummary	Optional	Summary information about the Academic Program	Optional	minOcc 0 maxOcc 1

Comment: This entire portion of the schema (Academic Program) would not normally be included in the schema for a high school transcript.

Code illustration:

```

<AcademicProgram>
  <ProgramCIPCode />
  <AcademicProgramType>Major</AcademicProgramType>
  <AcademicProgramName>General Transfer Track</AcademicProgramName>
  <NoteMessage />
  <ProgramSummary>

  </ProgramSummary>
</AcademicProgram>
    
```

Student.AcademicRecord.AcademicSession.AcademicProgram. ProgramSummary

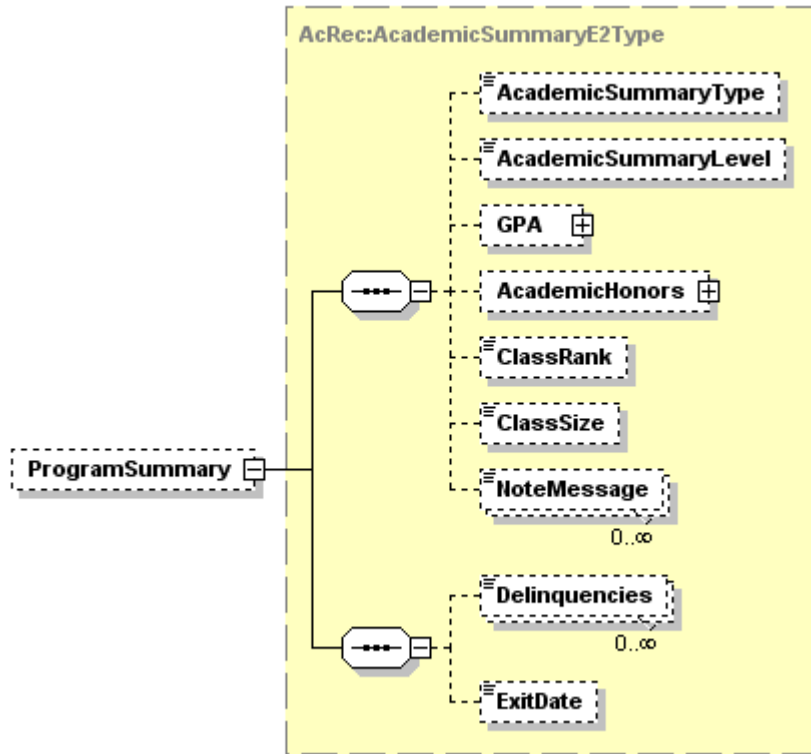

Tag Name	Schema Use	Description	Recommended Use	Format
AcademicSummaryType	Optional	<p>Summary Type is an indication of what is being summarized over what period of time</p> <p><i>All</i> - Summary of all courses regardless of institution</p> <p><i>SenderOnly</i> - Summary of all courses at sending institution (or recorded as if they were taken at the sending institution)</p> <p><i>TransferOnly</i> - Summary of transfer work (courses taken at other than the sending institution)</p> <p><i>AllNotRepeated</i> - Summary of all courses except for repeated or forgiven courses/credits</p> <p><i>SenderNotRepeated</i> - Summary of all courses at sending institution except for repeated or forgiven courses/credits</p> <p><i>TransferNotRepeated</i> - Summary of transfer work except for repeated or forgiven courses/credits</p> <p><i>AcademicRenewal</i> - Subset of forgiven courses</p> <p><i>CarryoverCredit</i> - Summary from offline records and used as the initial point for cumulatives and averages</p>	Recommended	minOcc 0 maxOcc 1 Enumerations: All SenderOnly TransferOnly AllNotRepeated SenderNotRepeated TransferNotRepeated AcademicRenewal CarryoverCredit DegreeApplicable NonDegreeApplicable ConvertedFrom ConvertedTo UserDefined Weighted NonWeighted

Tag Name	Schema Use	Description	Recommended Use	Format
		<p><i>DegreeApplicable</i> - Summary of course that apply to degree</p> <p><i>NonDegreeApplicable</i> - Summary of courses that do not apply toward degree</p> <p><i>ConvertedFrom</i> - Summary of credits before an institutional term-basis conversion, such as from quarters to semesters</p> <p><i>Weighted</i> – Summary that gives additional (higher) value to specific courses taken by a student, such as honors courses, International Baccalaureate, Advanced Placement, high school /college dual enrollment.</p> <p><i>NonWeighted</i> – Summary that does not give additional value to courses, regardless of special characteristics of the courses. For example, if the grading scale is from 0 to 4.00, then it is not possible to have a summary higher than 4.00.</p> <p><i>ConvertedTo</i> - Summary of credits after an institutional term-basis conversion, such as from quarters to semesters</p> <p><i>UserDefined</i> - see NoteMessage for explanation</p>		
AcademicSummaryLevel	Optional	<p>The level of credit associated with the credit hours earned for the course.</p> <p><i>Undergraduate</i> - Undergraduate</p> <p><i>LowerDivision</i> - Lower division credit (associated with first/second year)</p> <p><i>UpperDivision</i> - Higher or upper division credit (associated with third or fourth year)</p> <p><i>Vocational</i> - Vocational/technical credit</p> <p><i>TechnicalPreparatory</i> - Tech Prep credit</p> <p><i>Graduate</i> - Graduate level credit</p> <p><i>Professional</i> - Professional</p> <p><i>Dual</i> - Dual level (upper division and graduate- may be applicable to a bachelor's degree or graduate degree or both)</p> <p><i>GraduateProfessional</i> - Dual level (graduate and professional- may be applicable to both)</p>	Not Recommended	<p>minOcc 0</p> <p>maxOcc 1</p> <p>Enumerations:</p> <p>Undergraduate</p> <p>LowerDivision</p> <p>UpperDivision</p> <p>Vocational</p> <p>TechnicalPreparatory</p> <p>Graduate</p> <p>Professional</p> <p>Dual</p> <p>GraduateProfessional</p>
Comment: None of these values is appropriate for the high school transcript.				
GPA	Optional	GPA for the Academic Program	Not Recommended	<p>minOcc 0</p> <p>maxOcc 1</p>
Comment: It would be unusual to find the student's GPA, in an academic program within a session or term, on a high school transcript.				
AcademicHonors	Optional	Honors for the Award Program	Not Recommended	<p>minOcc 0</p> <p>maxOcc 1</p>
Comment: It would be unusual to find Academic Honors, in an academic program within a session or term on a high school transcript.				

Tag Name	Schema Use	Description	Recommended Use	Format
ClassRank	Optional	The student's class rank relative to other students in their academic cohort (e.g. class).	Not Recommended	minOcc 0 maxOcc 1 minInclusive 1 maxInclusive 9999 totalDigits 4
Comment: It would be unusual to find the student's Class Rank, in an academic program within a session or term, on a high school transcript. So, it is not recommended to include the student's Class Rank at this point in the Schema.				
ClassSize	Optional	The numeric size of the academic cohort (e.g. class).	Not Recommended	minOcc 0 maxOcc 1 minInclusive 1 maxInclusive 9999 totalDigits 4
Comment: It would be unusual to find the size of the student's class, in an academic program within a session or term, on a high school transcript.				
NoteMessage	Optional Repeatable	Additional information about the Program Summary	Not Recommended	minOcc 0 maxOcc ∞ minLength 1 maxLength 80
Comment: If class rank and class size are provided, a note might be appropriate to describe the cohort and when the ranking occurred:				
Delinquencies	Optional Repeatable	The academic standing of the student upon transfer to the institution. <i>GoodStanding</i> - Student was in good standing <i>ProbationGPA</i> - Student was on academic probation (because of low GPA) <i>ProbationHours</i> - Student was on academic probation (deficiency in credit hours) <i>SuspensionGPA</i> - Student was on academic suspension (because of low GPA) <i>SuspensionHours</i> - Student was on academic suspension (deficiency in credit hours) <i>ProbationDiscipline</i> - Student was on disciplinary probation <i>SuspensionDiscipline</i> - Student was on disciplinary suspension <i>Unknown</i> <i>Other</i>	Not Recommended	minOcc 0 maxOcc ∞ Enumeration: GoodStanding ProbationGPA ProbationHours SuspensionGPA SuspensionHours ProbationDiscipline SuspensionDiscipline Unknown Other
ExitDate	Optional	The date on which the student officially withdrew or graduated.	Not Recommended	minOcc 0 maxOcc 1 xs:date
Comment: This date would be the date the student withdrew or was removed from the academic program. The format for date is ccyy-mm-dd.				
Comment: This section of the transcript refers to a summary of the academic record for the specific academic program the student took within a specific academic session. This is not normally included in a high school transcript.				

**Student.AcademicRecord.AcademicSession.AcademicProgram.
ProgramSummary (Continued)**

Code illustration:

```
<ProgramSummary>  
  <AcademicSummaryType>All</AcademicSummaryType>  
  <AcademicSummaryLevel />  
  <GPA>  
  
    </GPA>  
  <AcademicHonors>  
  
    </AcademicHonors>  
  <ClassRank />  
  <ClassSize />  
  <NoteMessage />  
  <Delinquencies />  
  <ExitDate />  
</ProgramSummary>
```

Student.AcademicRecord.AcademicSession.AcademicProgram.
ProgramSummary.GPA

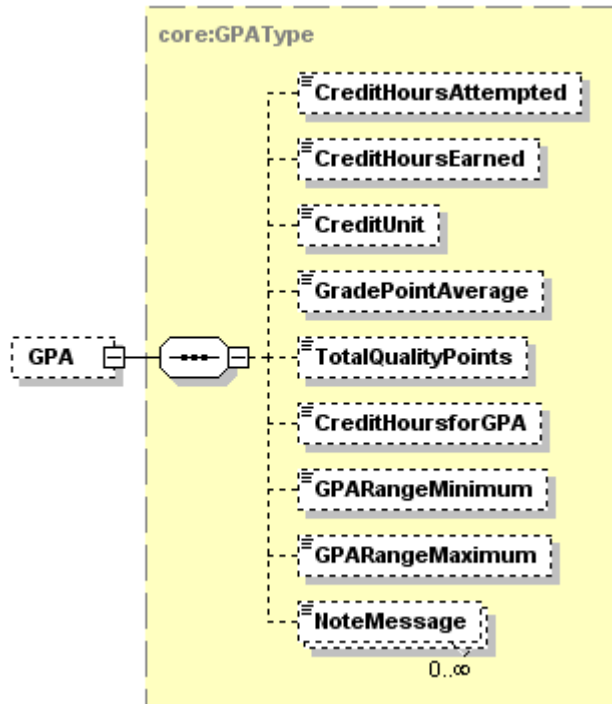

Tag Name	Schema Use	Description	Recommended Use	Format
CreditHoursAttempted	Optional	The total value of credit hours attempted whether or not included in the hours for GPA or hours earned.	Not Recommended	minOcc 0 maxOcc 1 xs:decimal
<p>Comment: This would also include the credit value of a course from which the student withdrew, if it appears on the transcript. So if a student had enrolled in 10 Carnegie Units which are all included in the specified program and appear on the transcript, and had passed 5 units and withdrawn from 5 units, then the value of this field would be "10". If the student had enrolled for 10.5 units that are included in this program and are on the transcript, then the value of this field would be "10.5".</p>				
CreditHoursEarned	Optional	The total value of credit hours successfully completed or earned.	Not Recommended	minOcc 0 maxOcc 1 xs:decimal
<p>Comment: If the student had earned 5 Carnegie Units and they all counted toward this program for this diploma, then the value of this data element would be "5". If only 4.5 units were earned, then the value would be "4.5".</p>				
CreditUnit	Optional	The type of credit (unit, semester, or quarter) associated with the credit hours earned for the course.	Not Recommended	minOcc 0 maxOcc 1 Enumerations: NoCredit Quarter Semester Units ClockHours CarnegieUnits ContinuingEducationUnits Unreported Other
<p>Comment: Note that the credit unit is not necessarily directly related to the type of session in which a course is offered. A full year course, or a semester course, or a quarter course, may all offer Carnegie Units or Units as the credit unit.</p>				

Tag Name	Schema Use	Description	Recommended Use	Format
GradePointAverage	Optional	The value of the total quality points divided by the Credit Hours for Grade Point Average.	Not Recommended	minOcc 0 maxOcc 1 xs:decimal
Comment: For example, if the student had enrolled for 10 Carnegie Units that counted toward this diploma and this program, passed 8 units with grades of B worth 3 grade points for each Carnegie Unit, and 2 Carnegie Units with grades of F worth 0 grade points, then the calculation would be 24 grade points divided by 10 or a GPA of "2.4" or "2.40" or "2.400" depending on the policy of the sending school.				
TotalQualityPoints	Optional	The total value of quality points used for the calculation of the Grade Point Average.	Not Recommended	minOcc 0 maxOcc 1 xs:decimal
Comment: If a student earned all grades of B (worth 3 grade points for each Carnegie Unit) in 8.5 Carnegie Units that count toward this diploma and this program, then the value of this data element would be "25.5".				
CreditHoursforGPA	Optional	The total value of credit hours used to calculate the Grade Point Average.	Not Recommended	minOcc 0 maxOcc 1 xs:decimal
Comment: If a student earned grades of A (worth 4 grade points per unit) in 3 Carnegie Units in this program for this diploma; grades of F (worth 0 points per unit) in 4 units; and withdrew from 5 units, then the total credit hours for GPA for this diploma and this program would be "7".				
GPARangeMinimum	Optional	The minimum possible GPA	Not Recommended	minOcc 0 maxOcc 1 xs:decimal
GPARangeMaximum	Optional	The maximum possible GPA	Not Recommended	minOcc 0 maxOcc 1 xs:decimal
NoteMessage	Optional Repeatable	Additional information about the GPA	Not Recommended	minOcc 0 maxOcc ∞ minLength 1 maxLength 80
Comment: The GPA in this section of the Schema is for the student's academic program for a specific session. It would be very unusual to include this on a high school transcript, since the entire portion about the student's program is not normally included on a high school transcript.				

Code illustration:

```

<GPA>
  <CreditHoursAttempted />
  <CreditHoursEarned />
  <CreditUnit />
  <GradePointAverage />
  <TotalQualityPoints />
  <CreditHoursforGPA />
  <GPARangeMinimum />
  <GPARangeMaximum />
  <NoteMessage />
</GPA>
    
```

Student.AcademicRecord.AcademicSession.AcademicProgram.ProgramSummary.AcademicHonors

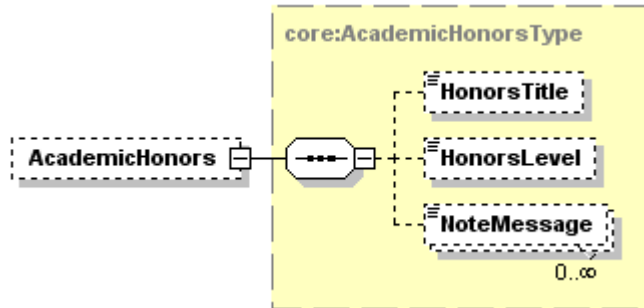

Tag Name	Schema Use	Description	Recommended Use	Format
HonorsTitle	Optional	The descriptive title for the honors received.	Not Recommended	minOcc 0 maxOcc 1 minLength 1 maxLength 30
HonorsLevel	Optional	A code value representing 1st highest honor, 2nd highest and 3rd highest.	Not Recommended	minOcc 0 maxOcc 1 Enumerations: FirstHighest SecondHighest ThirdHighest
NoteMessage	Optional Repeatabe	Additional information about the Academic Honors	Not Recommended	minOcc 0 maxOcc ∞ minLength 1 maxLength 80

Comment: The inclusion of honors awarded for a student's program for a specific session would not typically be found on a student's high school transcript, so this section of the Schema would not normally be included.

Code illustration:

```
<AcademicHonors>
  <HonorsTitle />
  <HonorsLevel />
  <NoteMessage />
</AcademicHonors>
```

Student.AcademicRecord.AcademicSession.AcademicAward

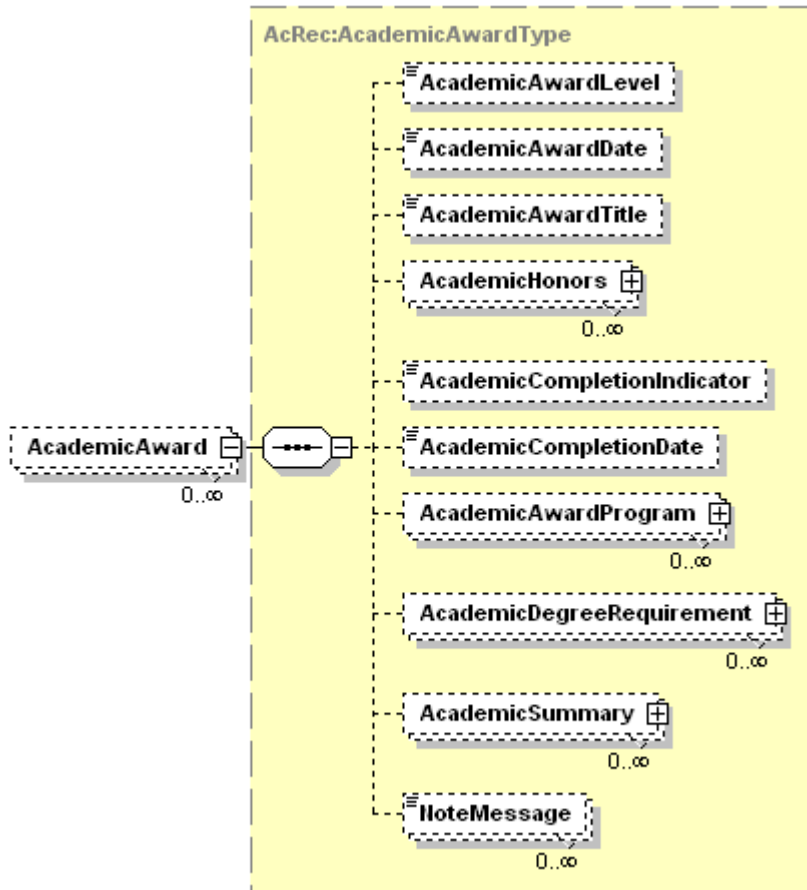

Tag Name	Schema Use	Description	Recommended Use	Format
AcademicAwardLevel	Optional	<p>The level of the degree, certificate, or award granted for the successful completion of requirements of an academic program.</p> <p>B17 Did not complete secondary school</p> <p>B18 Standard High School Diploma which may or may not include an exit test</p> <p>B19 Advanced or honors diploma</p> <p>B20 Vocational diploma</p> <p>B21 Special Education Diploma normally for students with a disability</p> <p>B22 Certificate of completion or attendance</p> <p>B23 Special certificate of completion or attendance</p> <p>B24 General Education Development (GED) Diploma</p> <p>B25 Other high school equivalency diploma</p> <p>B26 International diploma or certificate such as International Baccalaureate</p>	Recommended	<p>minOcc 0</p> <p>maxOcc 1</p> <p>Enumerations:</p> <p>B17</p> <p>B18</p> <p>B19</p> <p>B20</p> <p>B21</p> <p>B22</p> <p>B23</p> <p>B24</p> <p>B25</p> <p>B26</p> <p>B27</p> <p>B28</p>

Tag Name	Schema Use	Description	Recommended Use	Format
		B27 Standard High School Diploma with only 3 year curriculum B28 Met all graduation requirements except for required exit test		
AcademicAwardDate	Optional	The date on which the academic award was conferred.	Recommended	minOcc 0 maxOcc 1 xs:date
Comment: This is the nominal date when the award was granted. It might not be the same as the actual date of completion of the award requirements. If not the same, then this date will usually be later. The format for the date is ccyy-mm-dd.				
AcademicAwardTitle	Optional	The descriptive title for the academic award.	Recommended	minOcc 0 maxOcc 1 minLength 1 maxLength 80
Comment: The typical title for the award on a high school transcript would be "diploma."				
AcademicHonors	Optional Repeatable	Honors information for the academic award.	Recommended	minOcc 0 maxOcc ∞
AcademicCompletionIndicator	Optional	An indication that the degree-seeking student completed all of the requirements for his or her academic program. Not used for Non-Degree programs.	Recommended	minOcc 0 maxOcc 1 true/false
Comment: The value is "true" or "false" with all letters in lower case. The "true" condition would be typically be met on or before the date indicated in the "AcademicAwardDate" field, if that field is sent. If neither the completion date nor the award date is included, then sending this indicator is even more important.				
AcademicCompletionDate	Optional	The date on which the student's requirements for the degree were met or completed.	Recommended	minOcc 0 maxOcc 1 xs:date
Comment: This is the actual date when all requirements for the award were completed. It might not be the same as the nominal date of the award.				
AcademicAwardProgram	Optional Repeatable	Information related to the specific area of study (e.g., major) under which the award was granted.	Optional	minOcc 0 maxOcc ∞
Comment: The Academic Award Program would not normally be included on a high school transcript, so this part of the schema would not normally be sent.				
AcademicDegreeRequirement	Optional Repeatable	Thesis or dissertation information if required for the award.	Not Recommended	minOcc 0 maxOcc ∞
Comment: Thesis or dissertation is not appropriate for the high school transcript.				
AcademicSummary	Optional Repeatable	Academic summary information pertaining to the award.	Optional	minOcc 0 maxOcc ∞
NoteMessage	Optional Repeatable	Additional information about the academic award	Not Recommended	minOcc 0 maxOcc ∞ minLength 1 maxLength 80
Comment: This is the appropriate place in the Schema to include the awarding of the high school diploma if the high school normally includes it in the session in which all the requirements were met. However, the Workgroup that developed the PESC XML High School Transcript Schema recommends that the award of the high school diploma be included under Student.AcademicRecord.AcademicAward.				

**Student.AcademicRecord.AcademicSession.AcademicAward
(Continued)**

Code illustration:

```
<AcademicAward>
  <AcademicAwardLevel>B18</AcademicAwardLevel>
  <AcademicAwardDate>2005-05-09</AcademicAwardDate>
  <AcademicAwardTitle>Standard Diploma</AcademicAwardTitle>
  <AcademicHonors>

  </AcademicHonors>
  <AcademicCompletionIndicator>true</AcademicCompletionIndicator>
  <AcademicCompletionDate>2005-05-09</AcademicCompletionDate>
  <AcademicAwardProgram>

  </AcademicAwardProgram>
  <AcademicDegreeRequirement>

  </AcademicDegreeRequirement>
  <AcademicSummary>

  </AcademicSummary>
  <NoteMessage />
</AcademicAward>
```

Student.AcademicRecord.AcademicSession.AcademicAward.AcademicHonors

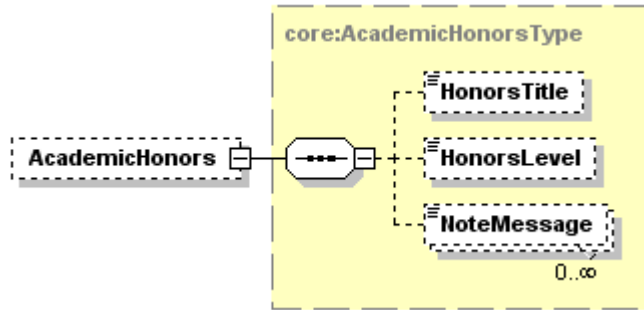

Tag Name	Schema Use	Description	Recommended Use	Format
HonorsTitle	Optional	The descriptive title for the honors received	Recommended	minOcc 0 maxOcc 1 minLength 1 maxLength 30
Comment: There is a variety of names for these honors in the United States. Some common ones are "Valdictorian", "Salutatorian", "With Honors", "Magna Cum Laude", etc.				
HonorsLevel	Optional	A code value representing 1st highest honor, 2nd highest and 3rd highest	Recommended	minOcc 0 maxOcc 1 Enumerations: FirstHighest SecondHighest ThirdHighest
NoteMessage	Optional Repeatable	Additional information about the academic honors	Not Recommended	minOcc 0 maxOcc ∞ minLength 1 maxLength 80
Comment: This is the appropriate place in the Schema to include any honors earned with the diploma if this is normally included in the session in which the diploma requirements were met. Examples might be "Salutatorian", "First Tier Award", "National Merit Scholar".				

Code illustration:

```

<AcademicHonors>
  <HonorsTitle>Summa Cum Laude</HonorsTitle>
  <HonorsLevel>FirstHighest</HonorsLevel>
  <NoteMessage />
</AcademicHonors>
  
```

**Student.AcademicRecord.AcademicSession.AcademicAward.
AcademicAwardProgram**

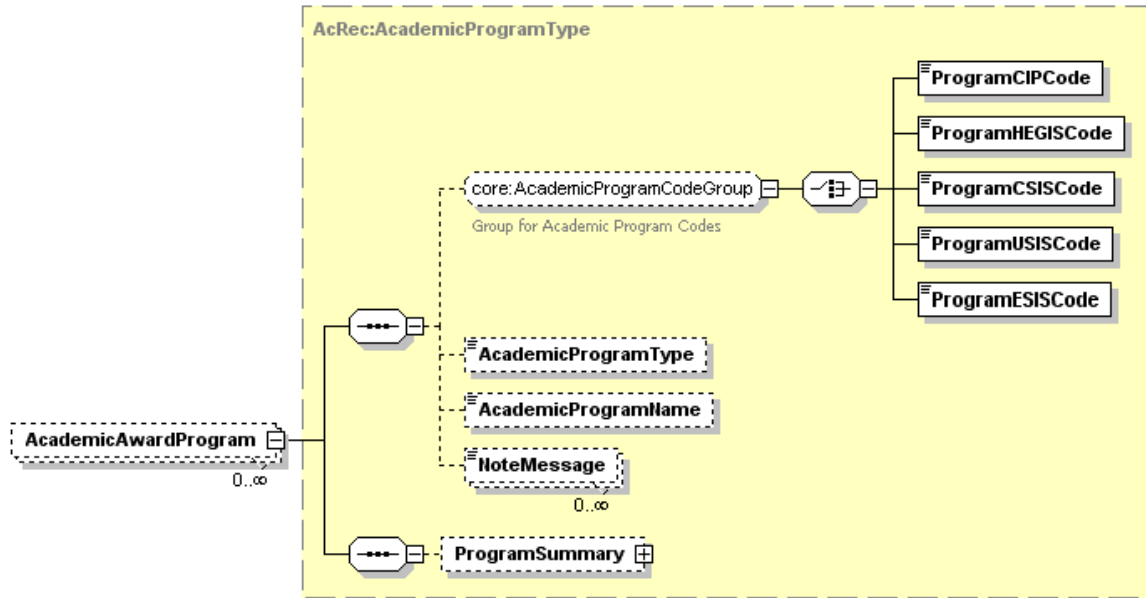

Tag Name	Schema Use	Description	Recommended Use	Format
ProgramCIPCode	Optional exclusive choice	Code indicating a discipline or field of study assigned by the Classification of Instructional Programs	Not Recommended	minOcc 0 maxOcc 1 minLength 6 maxLength 20
ProgramHEGISCode	Optional exclusive choice	Code indicating a discipline or field of study assigned by Higher Education General Information Survey	Not Recommended	minOcc 0 maxOcc 1 minLength 6 maxLength 20
ProgramCSISCode	Optional exclusive choice	Code indicating a discipline or field of study assigned by Statistics Canada Canadian College Student Information System	Not Recommended	minOcc 0 maxOcc 1 minLength 5 maxLength 5
ProgramUSISCode	Optional exclusive choice	Code indicating a discipline or field of study assigned by the Statistics Canada University Student Information System.	Not Recommended	minOcc 0 maxOcc 1 minLength 5 maxLength 5
ProgramESISCode	Optional exclusive choice	Code indicating a discipline or field of study assigned by the Statistics Canada Enhanced Student Information System.	Not Recommended	minOcc 0 maxOcc 1 minLength 1 maxLength 20
Comment: None of the above five choices is appropriate for indicating academic programs at US High Schools.				
AcademicProgramType	Optional	Indicates whether the academic program is a major, minor, area of concentration or specialization.	Optional	minOcc 0 maxOcc 1 Enumerations: Concentration Major Minor Specialization
AcademicProgramName	Optional	Literal name of program, major, or field of study.	Optional	minOcc 0 maxOcc 1 minLength 1 maxLength 60

Tag Name	Schema Use	Description	Recommended Use	Format
NoteMessage	Optional Repeatable	Additional information about the Academic Award Program	Not Recommended	minOcc 0 maxOcc ∞ minLength 1 maxLength 80
ProgramSummary	Optional	Summary information about the Academic Award Program	Optional	minOcc 0 maxOcc 1

Comment: This entire portion of the schema, which describes a student's academic program, would not normally be included in a high school transcript.

Code illustration:

```

<AcademicAwardProgram>
  <ProgramCIPCode />
  <AcademicProgramType>Major</AcademicProgramType>
  <AcademicProgramName>General Transfer Track</AcademicProgramName>
  <NoteMessage />
  <ProgramSummary>

  </ProgramSummary>
</AcademicAwardProgram>
    
```

**Student.AcademicRecord.AcademicSession.AcademicAward.
AcademicAwardProgram.ProgramSummary**

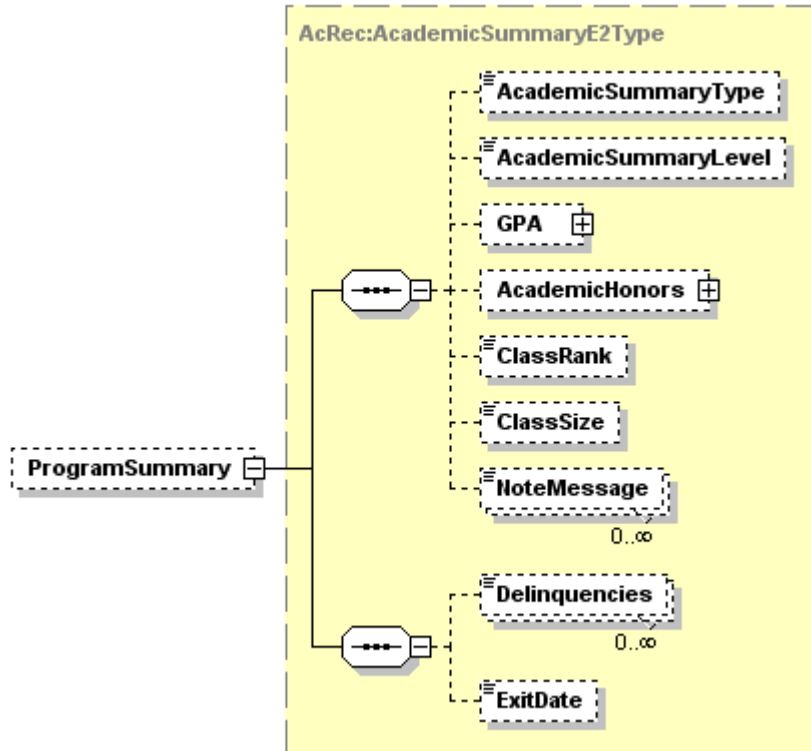

Tag Name	Schema Use	Description	Recommended Use	Format
AcademicSummaryType	Optional	<p>Summary Type is an indication of what is being summarized over what period of time</p> <p><i>All</i> - Summary of all courses regardless of institution</p> <p><i>SenderOnly</i> - Summary of all courses at sending institution (or recorded as if they were taken at the sending institution)</p> <p><i>TransferOnly</i> - Summary of transfer work (courses taken at other than the sending institution)</p> <p><i>AllNotRepeated</i> - Summary of all courses except for repeated or forgiven courses/credits</p> <p><i>SenderNotRepeated</i> - Summary of all courses at sending institution except for repeated or forgiven courses/credits</p> <p><i>TransferNotRepeated</i> - Summary of transfer work except for repeated or forgiven courses/credits</p> <p><i>AcademicRenewal</i> - Subset of forgiven courses</p> <p><i>CarryoverCredit</i> - Summary from offline records and used as the initial point for cumulatives and averages</p> <p><i>DegreeApplicable</i> - Summary of courses that apply to degree</p>	Not Recommended	<p>minOcc 0</p> <p>maxOcc 1</p> <p>Enumerations:</p> <ul style="list-style-type: none"> All SenderOnly TransferOnly AllNotRepeated SenderNotRepeated TransferNotRepeated AcademicRenewal CarryoverCredit DegreeApplicable NonDegreeApplicable ConvertedFrom ConvertedTo UserDefined Weighted NonWeighted

Tag Name	Schema Use	Description	Recommended Use	Format
		<p><i>NonDegreeApplicable</i> - Summary of courses that do not apply toward degree</p> <p><i>ConvertedFrom</i> - Summary of credits before an institutional term-basis conversion, such as from quarters to semesters</p> <p><i>ConvertedTo</i> - Summary of credits after an institutional term-basis conversion, such as from quarters to semesters</p> <p><i>UserDefined</i> - see NoteMessage for explanation</p> <p><i>Weighted</i> - Summary that gives additional (higher) value to specific courses taken by a student, such as honors courses, International Baccalaureate, Advanced Placement,, high school /college dual enrollment.</p> <p><i>NonWeighted</i> - Summary that does not give additional value to courses, regardless of special characteristics of the courses. For example, if the grading scale is from 0 to 4.00, then it is not possible to have a summary higher than 4.00.</p>		
AcademicSummaryLevel	Optional	<p>The level of credit associated with the credit hours earned for the course.</p> <p>Undergraduate - Undergraduate</p> <p>LowerDivision - Lower division credit (associated with first/second year)</p> <p>UpperDivision - Higher or upper division credit (associated with third or fourth year)</p> <p>Vocational - Vocational/technical credit</p> <p>TechnicalPreparatory - Tech Prep credit</p> <p>Graduate - Graduate level credit</p> <p>Professional - Professional</p> <p>Dual - Dual level (upper division and graduate- may be applicable to a bachelor's degree or graduate degree or both)</p> <p>GraduateProfessional - Dual level (graduate and professional- may be applicable to both)</p>	Not Recommended	<p>minOcc 0</p> <p>maxOcc 1</p> <p>Enumerations:</p> <p>Undergraduate</p> <p>LowerDivision</p> <p>UpperDivision</p> <p>Vocational</p> <p>TechnicalPreparatory</p> <p>Graduate</p> <p>Professional</p> <p>Dual</p> <p>GraduateProfessional</p>
Comment: None of these values seems appropriate for the high school transcript.				
GPA	Optional	GPA for the Award Program	Optional	<p>minOcc 0</p> <p>maxOcc 1</p>
Comment: This complex data element will be expanded on page XXX which follows.				
AcademicHonors	Optional	Honors for the Award Program	Optional	<p>minOcc 0</p> <p>maxOcc 1</p>
Comment: This complex data element will be expanded on page XXX which follows.				
ClassRank	Optional	The student's class rank relative to other students in their academic cohort (e.g. class).	Optional	<p>minOcc 0</p> <p>maxOcc 1</p> <p>minInclusive 1</p> <p>maxInclusive 9999</p> <p>totalDigits 4</p>

Tag Name	Schema Use	Description	Recommended Use	Format
ClassSize	Optional	The numeric size of the academic cohort (e.g. class).	Optional	minOcc 0 maxOcc 1 minInclusive 1 maxInclusive 9999 totalDigits 4
NoteMessage	Optional Repeatable	Additional information about the Program Summary	Not Recommended	minOcc 0 maxOcc ∞ minLength 1 maxLength 80
Delinquencies	Optional Repeatable	The academic standing of the student upon transfer to the institution. <i>GoodStanding</i> - Student was in good standing <i>ProbationGPA</i> - Student was on academic probation (because of low GPA) <i>ProbationHours</i> - Student was on academic probation (deficiency in credit hours) <i>SuspensionGPA</i> - Student was on academic suspension (because of low GPA) <i>SuspensionHours</i> - Student was on academic suspension (deficiency in credit hours) <i>ProbationDiscipline</i> - Student was on disciplinary probation <i>SuspensionDiscipline</i> - Student was on disciplinary suspension <i>Unknown</i> <i>Other</i>	Not Recommended	minOcc 0 maxOcc ∞ Enumerations: GoodStanding ProbationGPA ProbationHours SuspensionGPA SuspensionHours ProbationDiscipline SuspensionDiscipline Unknown Other
ExitDate	Optional	The date on which the student officially withdrew or graduated.	Not Recommended	minOcc 0 maxOcc 1 xs:date

Comment: This would be the date the student withdrew or graduated from a specific program. This would not normally be included in the high school transcript. If used, the date format is ccyy-mm-dd.

Comment: This section of the transcript refers to a summary of the Academic Award Program for a specific Academic Session. This is not normally included in a high school transcript.

Code illustration:

```

<ProgramSummary>
  <AcademicSummaryType />
  <AcademicSummaryLevel />
  <GPA>

  </GPA>
  <AcademicHonors>

  </AcademicHonors>
  <ClassRank>126</ClassRank>
  <ClassSize>342</ClassSize>
  <NoteMessage />
  <Delinquencies />
  <ExitDate />
</ProgramSummary>
    
```

Student.AcademicRecord.AcademicSession.AcademicAward.
AcademicAwardProgram.ProgramSummary.GPA

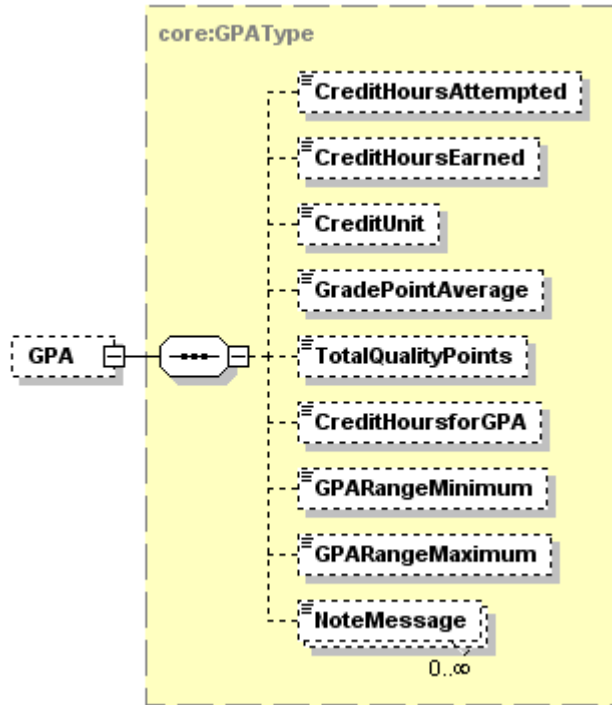

Tag Name	Schema Use	Description	Recommended Use	Format
CreditHoursAttempted	Optional	The total value of credit hours attempted whether or not included in the hours for GPA or hours earned.	Recommended	minOcc 0 maxOcc 1 xs:decimal
<p>Comment: This would also include the credit value of a course from which the student withdrew, if it appears on the transcript. So if a student had enrolled in 10 Carnegie Units which are all included in the specified program in this session and appear on the transcript, and had passed 5 units and withdrawn from 5 units, then the value of this field would be "10". If the student had enrolled for 10.5 units that are included in this program in this session and are on the transcript, then the value of this field would be "10.5".</p>				
CreditHoursEarned	Optional	The total value of credit hours successfully completed or earned.	Recommended	minOcc 0 maxOcc 1 xs:decimal
<p>Comment: If the student had earned 5 Carnegie Units and they all counted toward this program in this session for this diploma, then the value of this data element would be "5". If only 4.5 units were earned, then the value would be "4.5".</p>				
CreditUnit	Optional	The type of credit (unit, semester, or quarter) associated with the credit hours earned for the course.	Recommended	minOcc 0 maxOcc 1 Enumeration: NoCredit Quarter Semester Units ClockHours CarnegieUnits ContinuingEducationUnits Unreported Other
<p>Comment: Note that the credit unit is not necessarily directly related to the type of session in which a course is offered. A full year course, or a semester course, or a quarter course, may all offer Carnegie Units or Units as the credit unit.</p>				

Tag Name	Schema Use	Description	Recommended Use	Format
GradePointAverage	Optional	The value of the total quality points divided by the Credit Hours for Grade Point Average.	Recommended	minOcc 0 maxOcc 1 xs:decimal
Comment: For example, if the student had enrolled for 10 Carnegie Units that counted toward this diploma and this program in this session, passed 8 units with grades of B worth 3 grade points for each Carnegie Unit, and 2 Carnegie Units with grades of F worth 0 grade points, then the calculation would be 24 grade points divided by 10 or a GPA of "2.4" or "2.40" or "2.400" depending on the policy of the sending school.				
TotalQualityPoints	Optional	The total value of quality points used for the calculation of the Grade Point Average.	Recommended	minOcc 0 maxOcc 1 xs:decimal
Comment: If a student earned all grades of B (worth 3 grade points for each Carnegie Unit) in 8.5 Carnegie Units that count toward this diploma and this program in this session, then the value of this data element would be "25.5".				
CreditHoursforGPA	Optional	The total value of credit hours used to calculate the Grade Point Average.	Recommended	minOcc 0 maxOcc 1 xs:decimal
Comment: If a student earned grades of A (worth 4 grades points per unit) in 3 Carnegie Units in this program for this diploma in this session; grades of F (worth 0 points per unit) in 4 units; and withdrew from 5 units, then the total credit hours for GPA for this diploma and this program in this session would be "7".				
GPARangeMinimum	Optional	The minimum possible GPA	Recommended	minOcc 0 maxOcc 1 xs:decimal
Comment: If the lowest possible grade is an F and a grade of F is valued at 0 grade points, then this value would be "0", or "0.0" or "0.00".				
GPARangeMaximum	Optional	The maximum possible GPA	Recommended	minOcc 0 maxOcc 1 xs:decimal
Comment: If the highest possible grade is an A and a grade of A is valued at 4 grade points, then this value would be "4" or "4.0" or "4.00", etc.				
NoteMessage	Optional Repeatable	Additional information about the GPA	Not Recommended	minOcc 0 maxOcc ∞ minLength 1 maxLength 80
Comment: Since information about the student's academic program is not normally included on a high school transcript, then this entire section about the GPA for the student's program would not normally be included.				

Code illustration:

```

<GPA>
  <CreditHoursAttempted>12</CreditHoursAttempted>
  <CreditHoursEarned>12</CreditHoursEarned>
  <CreditUnit>CarnegieUnits</CreditUnit>
  <GradePointAverage>3.75</GradePointAverage>
  <TotalQualityPoints>45</TotalQualityPoints>
  <CreditHoursforGPA>12</CreditHoursforGPA>
  <GPARangeMinimum>0</GPARangeMinimum>
  <GPARangeMaximum>4</GPARangeMaximum>
  <NoteMessage />
</GPA>
    
```

Student.AcademicRecord.AcademicSession.AcademicAward.Academic AwardProgram.ProgramSummary.AcademicHonors

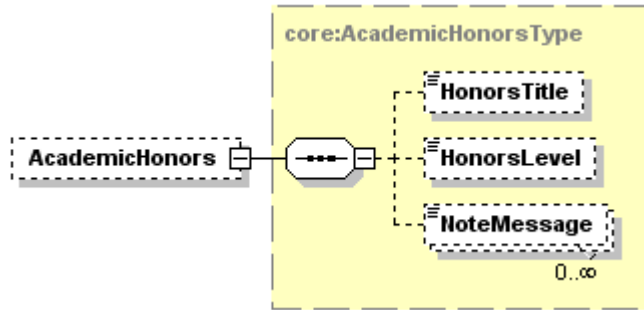

Tag Name	Schema Use	Description	Recommended Use	Format
HonorsTitle	Optional	The descriptive title for the honors received.	Not Recommended	minOcc 0 maxOcc 1 minLength 1 maxLength 30
HonorsLevel	Optional	A code value representing 1st highest honor, 2nd highest and 3rd highest.	Not Recommended	minOcc 0 maxOcc 1 Enumerations: FirstHighest SecondHighest ThirdHighest
NoteMessage	Optional Repeatable	Additional information about the Academic Honors	Not Recommended	minOcc 0 maxOcc ∞ minLength 1 maxLength 80

Comment: This entire section of the schema for honors awarded for a specific program in a specific session as part of a high school diploma would not normally be included on a high school transcript.

Code illustration:

```
<AcademicHonors>
  <HonorsTitle />
  <HonorsLevel />
  <NoteMessage />
</AcademicHonors>
```

Student.AcademicRecord.AcademicSession.AcademicAward.AcademicDegreeRequirement

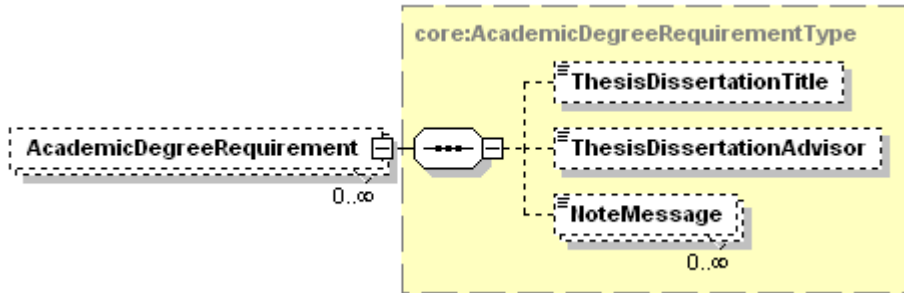

Tag Name	Schema Use	Description	Recommended Use	Format
ThesisDissertationTitle	Optional	The title of the thesis or dissertation.	Not Recommended	minOcc 0 maxOcc 1 minLength 1 maxLength
ThesisDissertationAdvisor	Optional	The advisor (Major Professor) who supervised the Thesis or Dissertation on behalf of the student earning the degree.	Not Recommended	minOcc 0 maxOcc 1 minLength 1 maxLength 45
NoteMessage	Optional Repeatable	Additional information about the Academic Degree Requirement	Not Recommended	minOcc 0 maxOcc ∞ minLength 1 maxLength 80

Comment: It is not recommended to include Academic Degree Requirement in the High School Transcript, since it is inappropriate.

Code illustration:

```
<AcademicDegreeRequirement>
  <ThesisDissertationTitle />
  <ThesisDissertationAdvisor />
  <NoteMessage />
</AcademicDegreeRequirement>
```

Student.AcademicRecord.AcademicSession.AcademicAward. AcademicSummary

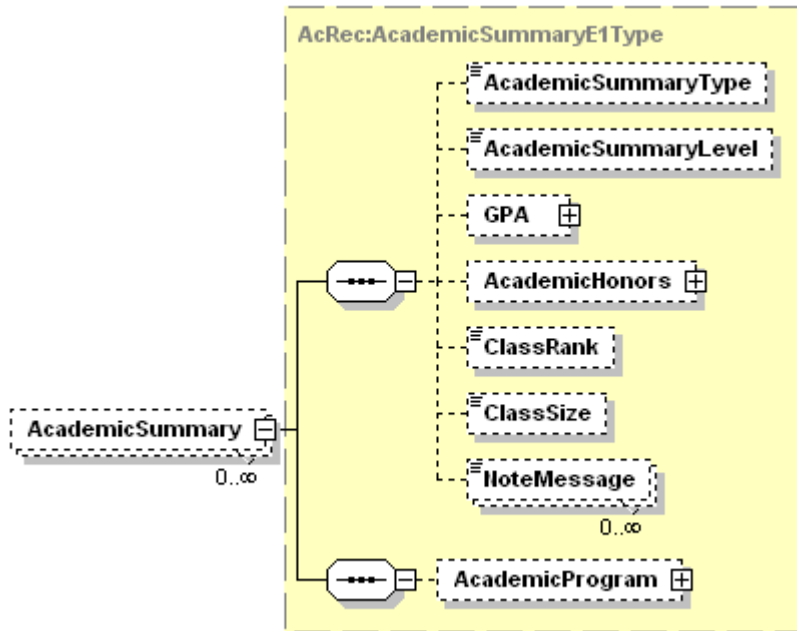

Tag Name	Schema Use	Description	Recommended Use	Format
AcademicSummaryType	Optional	<p>Summary Type is an indication of what is being summarized over what period of time</p> <p><i>All</i> - Summary of all courses regardless of institution</p> <p><i>SenderOnly</i> - Summary of all courses at sending institution (or recorded as if they were taken at the sending institution)</p> <p><i>TransferOnly</i> - Summary of transfer work (courses taken at other than the sending institution)</p> <p><i>AllNotRepeated</i> - Summary of all courses except for repeated or forgiven courses/credits</p> <p><i>SenderNotRepeated</i> - Summary of all courses at sending institution except for repeated or forgiven courses/credits</p> <p><i>TransferNotRepeated</i> - Summary of transfer work except for repeated or forgiven courses/credits</p> <p><i>AcademicRenewal</i> - Subset of forgiven courses</p> <p><i>CarryoverCredit</i> - Summary from offline records and used as the initial point for cumulatives and averages</p> <p><i>DegreeApplicable</i> - Summary of course that apply to degree</p> <p><i>NonDegreeApplicable</i> - Summary of courses that do not apply toward degree</p>	Recommended	<p>minOcc 0</p> <p>maxOcc 1</p> <p>Enumerations:</p> <p>All</p> <p>SenderOnly</p> <p>TransferOnly</p> <p>AllNotRepeated</p> <p>SenderNotRepeated</p> <p>TransferNotRepeated</p> <p>AcademicRenewal</p> <p>CarryoverCredit</p> <p>DegreeApplicable</p> <p>NonDegreeApplicable</p> <p>ConvertedFrom</p> <p>ConvertedTo</p> <p>UserDefined</p> <p>Weighted</p> <p>NonWeighted</p>

Tag Name	Schema Use	Description	Recommended Use	Format
		<p><i>Weighted</i> – Summary that gives additional (higher) value to specific courses taken by a student, such as honors courses, International Baccalaureate, Advanced Placement, high school /college dual enrollment.</p> <p><i>NonWeighted</i> – Summary that does not give additional value to courses, regardless of special characteristics of the courses. For example, if the grading scale is from 0 to 4.00, then it is not possible to have a summary higher than 4.00.</p> <p><i>ConvertedFrom</i> - Summary of credits before an institutional term-basis conversion, such as from quarters to semesters</p> <p><i>ConvertedTo</i> - Summary of credits after an institutional term-basis conversion, such as from quarters to semesters</p> <p><i>UserDefined</i> - see NoteMessage for explanation</p>		
AcademicSummaryLevel	Optional	The level of credit associated with the credit hours earned for the course.	Not Recommended	minOcc 0 maxOcc 1 Enumerations: Undergraduate LowerDivision UpperDivision Vocational TechnicalPreparatory Graduate Professional Dual GraduateProfessional
Comment: None of these values seem appropriate for the high school transcript.				
GPA	Optional	GPA for the Academic Award	Recommended	minOcc 0 maxOcc 1
Comment: This is the GPA for the high school diploma when it is part of an academic session. This complex data element will be expanded on page XXX which follows.				
AcademicHonors	Optional	Honors for the Academic Award	Recommended	minOcc 0 maxOcc 1
Comment: This complex data element will be expanded on page XXX which follows.				
ClassRank	Optional	The student's class rank relative to other students in their academic cohort (e.g. class).	Not Recommended	minOcc 0 maxOcc 1 minInclusive 1 maxInclusive 9999 totalDigits 4
Comment: The Workgroup that developed this PESC XML High School Transcript Schema recommends that this is not the most appropriate place to include a student's rank in class. Instead, if it is included in the high school transcript, a more appropriate place would be Student.AcademicRecord.AcademicSummary.				
ClassSize	Optional	The numeric size of the academic cohort (e.g. class).	Not Recommended	minOcc 0 maxOcc 1 minInclusive 1 maxInclusive 9999 totalDigits 4
NoteMessage	Optional Repeatable	Additional information about the Academic Summary	Not Recommended	minOcc 0 maxOcc ∞ minLength 1 maxLength 80

Tag Name	Schema Use	Description	Recommended Use	Format
AcademicProgram	Optional	Academic Program(s) related to this Academic Summary	Not Recommended	minOcc 0 maxOcc 1

Comment: While academic award programs and summaries can be communicated in several different elements, it is recommended that they be reported at the highest appropriate level. E.G., use *AcademicAward.AcademicAwardProgram* to indicate degree major; *AcademicAward.AcademicAwardProgram.ProgramSummary* for degree major GPA and honors; *AcademicAward.AcademicSummary* for degree GPA and honors.

Code illustration:

```

<AcademicSummary>
  <AcademicSummaryType>All</AcademicSummaryType>
  <AcademicSummaryLevel />
  <GPA>

  </GPA>
  <AcademicHonors>

  </AcademicHonors>
  <ClassRank>43</ClassRank>
  <ClassSize>849</ClassSize>
  <NoteMessage />
  <AcademicProgram>

  </AcademicProgram>
</AcademicSummary>
    
```

Student.AcademicRecord.AcademicSession.AcademicAward.
AcademicSummary.GPA

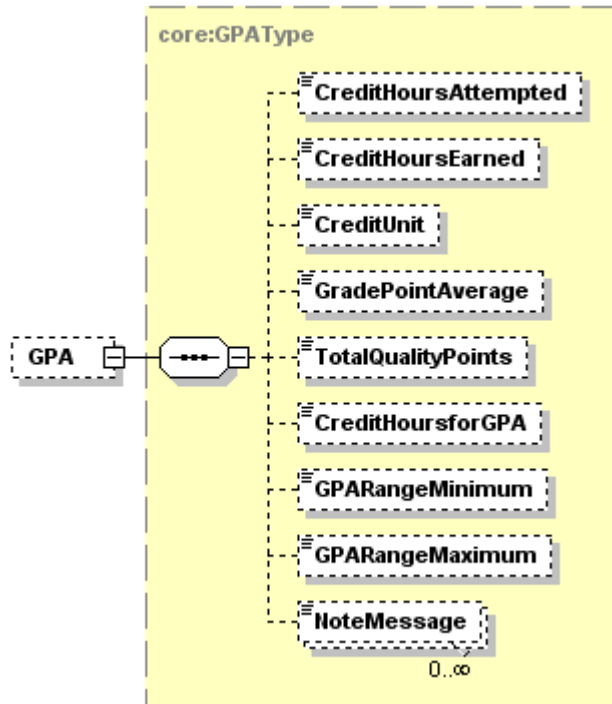

Tag Name	Schema Use	Description	Recommended Use	Format
CreditHoursAttempted	Optional	The total value of credit hours attempted whether or not included in the hours for GPA or hours earned.	Recommended	minOcc 0 maxOcc 1 xs:decimal
<p>Comment: This would include the credit value of a course from which the student withdrew, if it appears on the transcript. So if a student had enrolled in 10 Carnegie Units which are all included for this diploma in this session and are on the transcript, and had passed 5 units and withdrawn from 5 units, then the value of this field would be "10". If the student had enrolled for 10.5 units that are included for this diploma awarded in this session and are on the transcript, then the value of this field would be "10.5".</p>				
CreditHoursEarned	Optional	The total value of credit hours successfully completed or earned.	Recommended	minOcc 0 maxOcc 1 xs:decimal
<p>Comment: If the student had earned 5 Carnegie Units and they all counted toward this diploma awarded in this session, then the value of this data element would be "5". If only 4.5 units were earned, then the value would be "4.5".</p>				
CreditUnit	Optional	The type of credit (unit, semester, or quarter) associated with the credit hours earned for the course.	Recommended	minOcc 0 maxOcc 1 Enumerations: NoCredit Quarter Semester Units ClockHours CarnegieUnits ContinuingEducationUnits Unreported Other

Tag Name	Schema Use	Description	Recommended Use	Format
GradePointAverage	Optional	The value of the total quality points divided by the Credit Hours for Grade Point Average.	Recommended	minOcc 0 maxOcc 1 xs:decimal
Comment: For example, if the student had enrolled for 10 Carnegie Units that counted toward this diploma, passed 8 units with grades of B worth 3 quality points for each Carnegie Unit, and 2 Carnegie Units with grades of F worth 0 quality points, then the calculation would be 24 quality points divided by 10 or a GPA of "2.4" or "2.40" or "2.400" depending on the policy of the sending school.				
TotalQualityPoints	Optional	The total value of quality points used for the calculation of the Grade Point Average.	Recommended	minOcc 0 maxOcc 1 xs:decimal
Comment: If a student earned all grades of B (worth 3 quality points for each Carnegie Unit) in 8.5 Carnegie Units that count toward this diploma, then the value of this data element would be "25.5".				
CreditHoursforGPA	Optional	The total value of credit hours used to calculate the Grade Point Average.	Recommended	minOcc 0 maxOcc 1 xs:decimal
Comment: If a student earned grades of A (worth 4 quality points per unit) in 3 Carnegie Units for this diploma; grades of F (worth 0 quality points per unit) in 4 units; and withdrew from 5 units, then the total credit hours for GPA for this diploma would be "7".				
GPARangeMinimum	Optional	The minimum possible GPA	Recommended	minOcc 0 maxOcc 1 xs:decimal
Comment: If the lowest possible grade is an F and a grade of F is valued at 0 quality points, then this value would be "0", or "0.0" or "0.00", etc.				
GPARangeMaximum	Optional	The maximum possible GPA	Recommended	minOcc 0 maxOcc 1 xs:decimal
Comment: If the highest possible grade is an A and a grade of A is valued at 4 quality points, then this value would be "4" or "4.0" or "4.00", etc.				
NoteMessage	Optional Repeatable	Additional information about the GPA	Not Recommended	minOcc 0 maxOcc ∞ minLength 1 maxLength 80
Comment: The GPA reported in this section of the Schema is an overall GPA for all courses that count toward the diploma described in this section.				

Code illustration:

```

<GPA>
  <CreditHoursAttempted>12</CreditHoursAttempted>
  <CreditHoursEarned>12</CreditHoursEarned>
  <CreditUnit>CarnegieUnits</CreditUnit>
  <GradePointAverage>3.75</GradePointAverage>
  <TotalQualityPoints>45</TotalQualityPoints>
  <CreditHoursforGPA>12</CreditHoursforGPA>
  <GPARangeMinimum>0</GPARangeMinimum>
  <GPARangeMaximum>4</GPARangeMaximum>
  <NoteMessage />
</GPA>
    
```

**Student.AcademicRecord.AcademicSession.AcademicAward.
AcademicSummary.AcademicHonors**

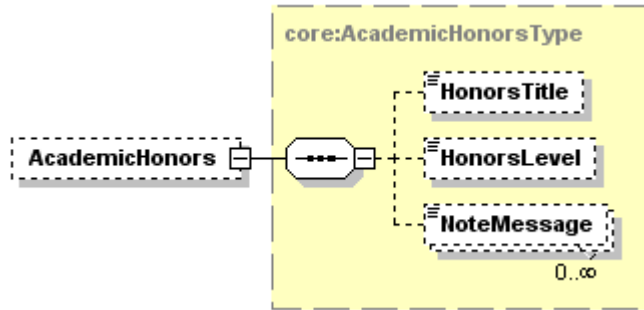

Tag Name	Schema Use	Description	Recommended Use	Format
HonorsTitle	Optional	The descriptive title for the honors received.	Recommended	minOcc 0 maxOcc 1 minLength 1 maxLength 30
HonorsLevel	Optional	A code value representing 1st highest honor, 2nd highest and 3rd highest.	Recommended	minOcc 0 maxOcc 1 Enumerations: FirstHighest SecondHighest ThirdHighest
NoteMessage	Optional Repeatable	Additional information about the Academic Honors	Not Recommended	minOcc 0 maxOcc ∞ minLength 1 maxLength 80

Comment: This would be the appropriate place to include any academic honors awarded with the diploma that is included in this session.

Code illustration:

```
<AcademicHonors>
  <HonorsTitle>Cum Laude</HonorsTitle>
  <HonorsLevel>ThirdHighest</HonorsLevel>
  <NoteMessage />
</AcademicHonors>
```

**Student.AcademicRecord.AcademicSession.AcademicAward.
AcademicSummary.AcademicProgram**

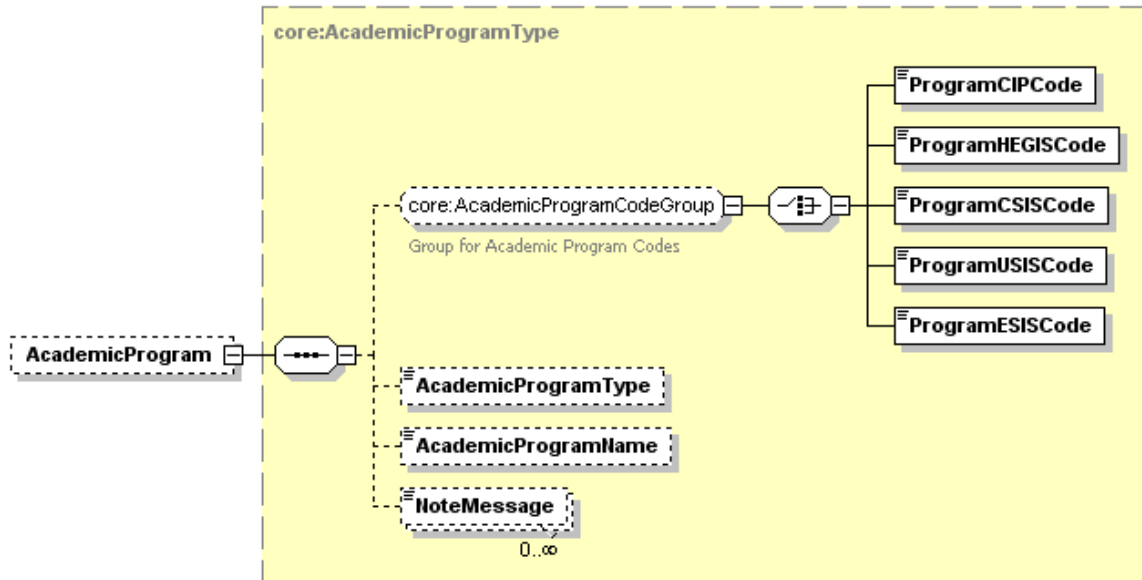

Tag Name	Schema Use	Description	Recommended Use	Format
ProgramCIPCode	Optional exclusive choice	Code indicating a discipline or field of study assigned by the Classification of Instructional Programs	Not Recommended	minOcc 0 maxOcc 1 minLength 6 maxLength 20
ProgramHEGISCode	Optional exclusive choice	Code indicating a discipline or field of study assigned by Higher Education General Information Survey	Not Recommended	minOcc 0 maxOcc 1 minLength 6 maxLength 20
ProgramCSISCode	Optional exclusive choice	Code indicating a discipline or field of study assigned by Statistics Canada Canadian College Student Information System	Not Recommended	minOcc 0 maxOcc 1 minLength 5 maxLength 5
ProgramUSISCode	Optional exclusive choice	Code indicating a discipline or field of study assigned by the Statistics Canada University Student Information System.	Not Recommended	minOcc 0 maxOcc 1 minLength 5 maxLength 5
ProgramESISCode	Optional exclusive choice	Code indicating a discipline or field of study assigned by the Statistics Canada Enhanced Student Information System.	Not Recommended	minOcc 0 maxOcc 1 minLength 1 maxLength 20
Comment: None of the above five choices is appropriate for describing academic programs at US High Schools.				
AcademicProgramType	Optional	Indicates whether the academic program is a major, minor, area of concentration or specialization.	Optional	minOcc 0 maxOcc 1 Enumerations: Concentration Major Minor Specialization
AcademicProgramName	Optional	Literal name of program, major, or field of study.	Recommended	minOcc 0 maxOcc 1 minLength 1 maxLength 60

Tag Name	Schema Use	Description	Recommended Use	Format
NoteMessage	Optional Repeatable	Additional information about the Academic Program	Not Recommended	minOcc 0 maxOcc ∞ minLength 1 maxLength 80

Comment: This entire portion of the schema related to a student's academic program is not normally included on a high school transcript.

Code illustration:

```

<AcademicProgram>
  <ProgramCIPCode />
  <AcademicProgramType>Major</AcademicProgramType>
  <AcademicProgramName>General Transfer Track</AcademicProgramName>
  <NoteMessage />
</AcademicProgram>
    
```

Student.AcademicRecord.AcademicSession.Course

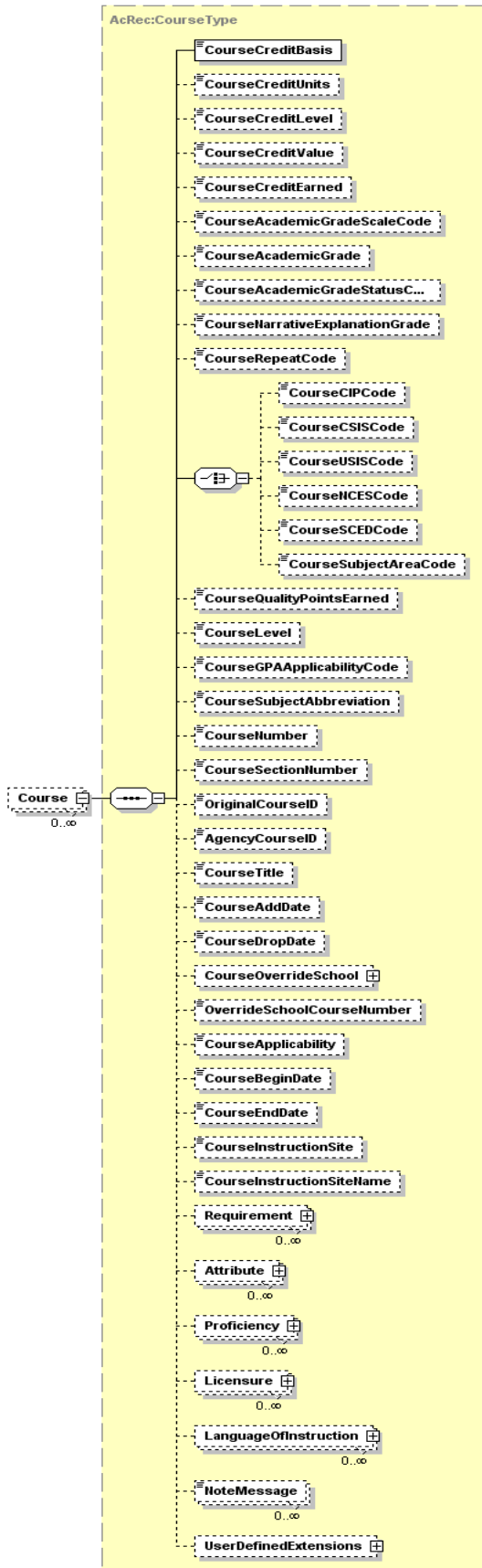

Tag Name	Schema Use	Description	Recommended Use	Format
CourseCreditBasis	Required	The type of enrollment associated with the credit hours for the course.	Required	minOcc 1 maxOcc 1 Enumerations: Regular AcademicRenewal AdvancedPlacement AdvancedStanding ContinuingEducation Exemption Equivalence InternationalBaccalaureate Military Remedial CreditByExam HighSchoolTransferCredit HighSchoolCreditOnly HighSchoolDualCredit JuniorHighSchoolCredit
CourseCreditUnits	Optional	The type of credit (unit, semester, or quarter) associated with the credit hours earned for the course.	Recommended	minOcc 0 maxOcc 1 Enumerations: NoCredit Quarter Semester Units ClockHours CarnegieUnits ContinuingEducationUnits Unreported Other
CourseCreditLevel	Optional	The level of credit associated with the credit hours earned for the course.	Not Recommended	minOcc 0 maxOcc 1 Enumerations: Undergraduate LowerDivision UpperDivision Vocational TechnicalPreparatory Graduate Professional Dual GraduateProfessional
Comment: These values are not appropriate for the high school transcript and should not be used.				
CourseCreditValue	Optional	Number indicating the credit hours that may be earned in the course.	Recommended	minOcc 0 maxOcc 1 xs:decimal
Comment: For example, if the course is worth 1 Carnegie Unit, and if the student withdrew from the course, but the course still appears on the high school transcript, then the value of this field is "1". Since it is a decimal field, it could also have a value of "1.0" or "1.00".				
CourseCreditEarned	Optional	The number of credits a student earned by the successful completion of a course.	Recommended	minOcc 0 maxOcc 1 xs:decimal
Comment: For example, if the course is worth 1 Carnegie Unit, and if the student passed the courset, then the value of this field is "1". Since it is a decimal field, it could also have a value of "1.0" or "1.00".				

Tag Name	Schema Use	Description	Recommended Use	Format
CourseAcademicGradeScaleCode	Optional	The grading scale used by an academic educational institution for an academic course.	Recommended	minOcc 0 maxOcc 1 See Appendix E
Comment: Grade scale is based on the American Medical Colleges Admissions Services (AMCAS) grade scale, values 01 through 99. See Appendix E for a complete list of code values.				
CourseAcademicGrade	Optional	The final grade awarded for participation in the course.	Recommended	minOcc 0 maxOcc 1 minLength 1 maxLength 10
CourseAcademicGradeStatusCode	Optional	Special enrollment or completion status of this course	Recommended	minOcc 0 maxOcc 1 Enumerations: AuditedCourse HonorsGrade Incomplete IncompleteNotResolvedFail InProgress NotYetReported OtherFailGrade OtherPassGrade PassFailFail PassFailPass TransferNoGrade Withdrew WithdrewFailing WithdrewNoPenalty WithdrewPassing
Comment: For crosswalk purposes from and to the ANSI ASC X12 EDI transaction grade scale codes, the equivalents are 500 – InProgress; 501 – PassFailPass; 502 – PassFailFail; 503 – CreditByExam; 504 – TransferNoGrade; 505 – Incomplete; 506 – WithdrewNoPenalty; 507 – WithdrewPassing; 509 – WithdrewFailing; 510 – HonorsGrade; 511 – AuditedCourse; 512 – Exempted; 513 – NotYetReported; 514 – IncompleteNotResolvedFail; 530 – OtherPassGrade; 531 – OtherFailGrade.				
CourseNarrativeExplanationGrade	Optional	The narrative of the grade awarded to a student in an academic course in those cases where a course does not receive a letter or numeric grade included in the grading scale of the Course Academic Grade Qualifier.	Not Recommended	minOcc 0 maxOcc 1 minLength 1 maxLength 200
CourseRepeatCode	Optional	Indicates that an academic course has been repeated by a student and how that repeat is to be computed in the student's academic grade average.	Recommended	minOcc 0 maxOcc 1 Enumerations: RepeatCounted RepeatNotCounted ReplacementCounted ReplacedNotCounted RepeatOtherInstitution NotCountedOther
Comment: If the sending high school has no policy on how to treat repeated courses, then this data element can be ignored by the sending high school. Likewise, if the receiving school has no policy or has a policy to ignore repeat calculations, then it can also be ignored. But if the sending school has such a policy, then this is the place to indicate that policy. For example, if the student previously took the same course, received a failing grade and has now completed this course with a passing grade, then the appropriate value might be "ReplacementCounted". Likewise, if this is the first attempt of the course, then this value might be "RepeatNotCounted".				
CourseCIPCode	Optional Choice	The Classification of Instructional Programs (CIP) code to describe the area of study for the course.	Not Recommended	minOcc 0 maxOcc 1 minLength 1 maxLength 10
CourseCSISCode	Optional Choice	The Statistics Canada Canadian College Student Information System (CCSIS) code to describe the area of study for the course.	Not Recommended	minOcc 0 maxOcc 1 minLength 1 maxLength 10

Tag Name	Schema Use	Description	Recommended Use	Format
CourseUSISCode	Optional Choice	The Statistics Canada University Student Information System (USIS) code to describe the area of study for the course.	Not Recommended	minOcc 0 maxOcc 1 minLength 1 maxLength 10
CourseNCESCode	Optional Choice	The code set developed (or being developed by the United States Department of Education's National Center for Education Statistics)	Optional (use one)	minOcc 0 maxOcc 1 minLength 1 maxLength 10
CourseSCEDCode	Optional Choice	The School Codes for the Exchange of Data (SCED) code set being developed for the United States Department of Education's National Center for Education Statistics to describe the content and level of a course	Optional (use one)	minOcc 0 maxOcc 1 minLength 12 maxLength 12

Comment: This is a code set that has just been approved by the National Center for Education Statistics. It is structured as follows:
 Digits 1, 2: This is the major subject area of course content in the high school course. Its breakdown is shown as the next data element (CourseSubjectAreaCode) which follows.
 Digits 3-5: A further breakdown of the course content in the high school course.
 Digit 6: Course Level (B for basic or remedial; G for general or regular; E for enriched or advanced, and H for honors).
 Digits 7-10: Available Credit. For example, a course offered as a 1 Carnegie Unit course would indicate 1.00
 Digits 11-12: Sequence of Courses. For example, 34 would be used to indicate this is the third course in a 4 course sequence.

CourseSubjectAreaCode	Optional Choice	This set of code values is derived from the first two digits of the CourseSCEDCode above.	Optional (use one)	minOcc 0 maxOcc 1 Enumerations: EnglishLanguageLiterature Mathematics LifePhysicalSciences SocialSciencesHistory FinePerformingArts ForeignLanguageLiterature ReligiousEducationTheology PhysicalHealthSafetyEducation MilitaryScience ComputerInformationSciences CommunicationsAudioVisual Technology BusinessMarketing Manufacturing HealthCareSciences PublicProtectiveGovernment Service HospitalityTourism ArchitectureConstruction AgriculturefoodNaturalResources HumanServices TransportationDistributionLogistics EngineeringTechnology Miscellaneous
-----------------------	--------------------	---	-----------------------	--

Comment: This is a code set that is based on the first two digits of the Course SCED Code above. The SCED Code is maintained by the US Department of Education's National Center for Education Statistics (NCES). If it is updated in the future, then PESC will keep this code set in synch with the first two digits of the SCED Code.

Tag Name	Schema Use	Description	Recommended Use	Format
CourseQualityPointsEarned	Optional	The numerical value assigned to a letter grade to provide a basis of quantitative determination of an average.	Recommended	minOcc 0 maxOcc 1 xs:decimal
<p>Comment: For example, if the student earned a grade of B in the course, and if the grade of B is worth 3 grade points, and if this course was worth 1 Carnegie Unit, then the value of this data element is "3". Likewise, for a course that is worth 0.5 Carnegie Units, a grade of B would be worth "1.5" CourseQualityPointsEarned.</p>				
CourseLevel	Optional	The level of work demonstrated by successful completion of the academic course being described	Recommended	minOcc 0 maxOcc 1 Enumerations: Accelerated AdultBasic AdvancedPlacement Basic InternationalBaccalaureate CollegeLevel CollegePreparatory GiftedTalented Honors NonAcademic Remedial SpecialEducation TechnicalPreparatory Vocational
CourseGPAApPLICabilityCode	Optional	An indicator of whether or not this course being described is included in the computation of the student's Grade Point Average, and if so, if it weighted differently from regular courses.	Recommended	minOcc 0 maxOcc 1 Enumerations: Applicable NotApplicable Weighted
CourseSubjectAbbreviation	Optional	The alphabetic abbreviation of the academic department or discipline offering the course. It is one part of the total course identifier number.	Recommended	minOcc 0 maxOcc 1 minLength 1 maxLength 10
<p>Comment: As with all recommended data elements, if the sending school does not use alphabetic abbreviations as part of the course numbering system, then this data element would not exist and would not be included.</p>				
CourseNumber	Optional	The official reference number portion of a course identifier. This number frequently designates the level of the course as well as the level of the student expected to enroll in the course	Recommended	minOcc 0 maxOcc 1 minLength 1 maxLength 15
CourseSectionNumber	Optional	The number assigned to differentiate among distinct occurrences of courses that have the same course abbreviation and number but are considered to be different courses.	Optional	minOcc 0 maxOcc 1 minLength 1 maxLength 10
<p>Comment: If course section number is used, it should probably be further explained in a note. If it only means, for example, that the course was taught at 9 am instead of 8 am, then it should probably not be included.</p>				

Tag Name	Schema Use	Description	Recommended Use	Format
OriginalCourseID	Optional	The course ID as it was listed when the credit was earned (e.g. before a system conversion) to show consistency between present transcripts and older ones.	Recommended	minOcc 0 maxOcc 1 minLength 1 maxLength 30
AgencyCourseID	Optional	The course ID that might have been assigned to this course by the state or other agency	Optional	minOcc 0 maxOcc 1 minLength 1 maxLength 30
CourseTitle	Optional	The name or title of the course taken by a student at an academic institution.	Recommended	minOcc 0 maxOcc 1 minLength 1 maxLength 60
CourseAddDate	Optional	The date a student was added to an academic course at a school.	Optional	minOcc 0 maxOcc 1 xs:date
Comment: Most high schools would not have this date readily available in the school's database. It would be of questionable value to the receiving postsecondary institution. The format of date is ccyy-mm-dd.				
CourseDropDate	Optional	The date on which the student drops or withdraws from the course.	Optional	minOcc 0 maxOcc 1 xs:date
Comment: If this date is readily available, it might be of some value to the receiving postsecondary institution. However, most postsecondary institutions would probably ignore this field.				
CourseOverrideSchool	Optional	The school where the credit was earned if different from the Academic Session School	Conditional	minOcc 0 maxOcc 1
Comment: This might be used when a full time student at one school is also taking one course at another high school, community college or university during the session by some sort of prior institutional agreement.				
OverrideSchoolCourseNumber	Optional	The course ID as it was listed at the school where the credit was earned	Conditional	minOcc 0 maxOcc 1 minLength 1 maxLength 35
Comment: CourseOverrideSchool and OverrideSchoolCourseNumber are normally used for situations like consortiums, concurrent enrollment or transfer courses, although transfer work is recommended to be reported in a separate session with an override school.				
CourseApplicability	Optional	The academic program to which this academic course applies toward graduation.	Not Recommended	minOcc 0 maxOcc 1 Enumeration: NotApplicable FirstProgram SecondProgram BothPrograms
CourseBeginDate	Optional	The official begin date for this course	Optional	minOcc 0 maxOcc 1 xs:date
Comment: The format of date is ccyy-mm-dd.				
CourseEndDate	Optional	The official end date for this course	Optional	minOcc 0 maxOcc 1 xs:date
Comment: CourseBeginDate and CourseEndDate are recommended when the dates differ from the session begin and end dates. The format for date is ccyy-mm-dd.				

Tag Name	Schema Use	Description	Recommended Use	Format
CourseInstructionSite	Optional	An indication of the type of location at which the course is taught.	Optional	minOcc 0 maxOcc 1 Enumerations: OnCampus OffCampus Extension StudyAbroad Correctional Military Telecommunication Auxiliary ClinicHospital
CourseInstructionSiteName	Optional	The name of the location at which the course is taught.	Optional	minOcc 0 maxOcc 1 minLength 1 maxLength 30
Requirement	Optional Repeatable	Curriculum requirements satisfied by successful completion of this course	Optional	minOcc 0 maxOcc ∞
Attribute	Optional Repeatable	Attributes of this course which may require special handling by the receiving institution	Optional	minOcc 0 maxOcc ∞
Proficiency	Optional Repeatable	Proficiency level signified by successful completion of this course	Optional	minOcc 0 maxOcc ∞
Licensure	Optional Repeatable	Licensure requirements satisfied by successful completion of this course	Optional	minOcc 0 maxOcc ∞
LanguageOfInstruction	Optional Repeatable	Language associated with one or more aspects of the course	Optional	minOcc 0 maxOcc ∞
Comment: This optional data element would not be sent if the language is English and the sending school is in the United States.				
NoteMessage	Optional Repeatable	Additional information about the course	Not Recommended	minOcc 0 maxOcc ∞ minLength 1 maxLength 80
UserDefinedExtensions	Optional	Additional structured information. Requires mutually defined XML schema.	Optional	minOcc 0 maxOcc 1

Comment: This is the appropriate place in the instance document to include courses taken at the sending school. It is also the appropriate place to include courses taken at another school if sufficient information is available to include data about the session at the other school.

Student.AcademicRecord.AcademicSession.Course (Continued)

Code illustration:

```

<Course>
  <CourseCreditBasis>Regular</CourseCreditBasis>
  <CourseCreditUnits>CarnegieUnits </CourseCreditUnits>
  <CourseCreditLevel />
  <CourseCreditValue>1</CourseCreditValue>
  <CourseCreditEarned>1</CourseCreditEarned>
  <CourseAcademicGradeScaleCode>25</CourseAcademicGradeScaleCode>
  <CourseAcademicGrade>A</CourseAcademicGrade>
  <CourseNarrativeExplanationGrade />
  <CourseRepeatCode>RepeatCounted</CourseRepeatCode>
  <CourseSCEDCode>04151H1.0011</CourseSCEDCode>
  <CourseSubjectAreaCode>SocialSciencesHistory</CourseSubjectAreaCode>
  <CourseQualityPointsEarned>4</CourseQualityPointsEarned>
  <CourseLevel>CollegePreparatory</CourseLevel>
  <CourseSubjectAbbreviation>HIS</CourseSubjectAbbreviation>
  <CourseNumber>201</CourseNumber>
  <CourseSectionNumber />
  <OriginalCourseID>HIST201</OriginalCourseID>
  <AgencyCourseID>HIS020201</AgencyCourseID>
  <CourseTitle>United States History 1</CourseTitle>
  <CourseAddDate>2005-09-01</CourseAddDate>
  <CourseDropDate />
  <CourseOverrideSchool>

  </CourseOverrideSchool>
  <OverrideSchoolCourseNumber />
  <CourseApplicability />
  <CourseBeginDate>2005-09-01</CourseBeginDate>
  <CourseEndDate>2005-12-07</CourseEndDate>
  <CourseInstructionSite>OnCampus</CourseInstructionSite>
  <CourseInstructionSiteName />
  <Requirement>

  </Requirement>
  <Attribute>

  </Attribute>
  <Proficiency>

  </Proficiency>
  <Licensure>

  </Licensure>
  <LanguageOfInstruction>

  </LanguageOfInstruction>
  <NoteMessage />
  <UserDefinedExtensions />
</Course>

```

Student.AcademicRecord.AcademicSession.Course.
CourseOverrideSchool

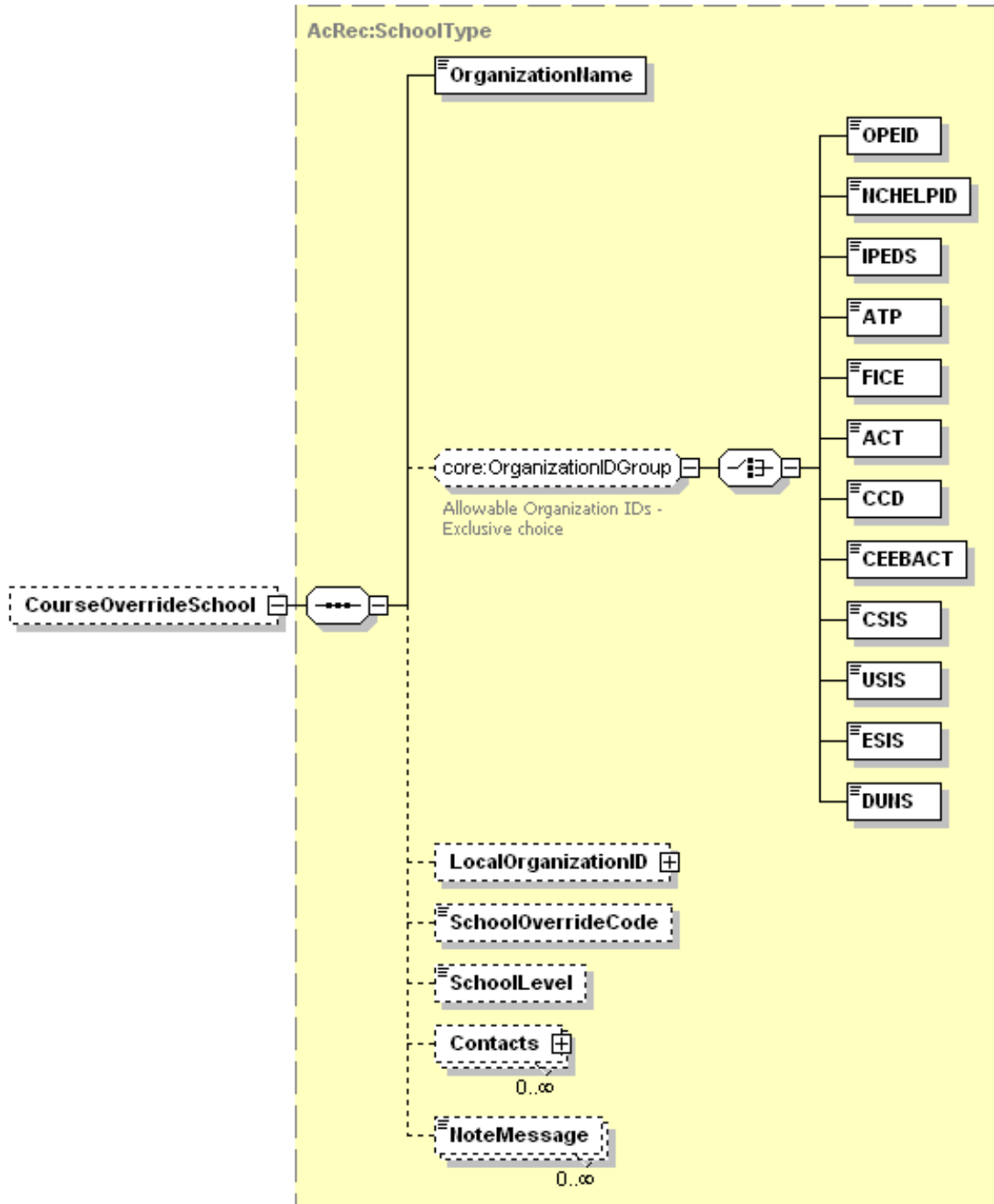

Tag Name	Schema Use	Description	Recommended Use	Format
OrganizationName	Required	Name of override school	Required	minOcc 1 maxOcc 1 minLength 1 maxLength 60

Tag Name	Schema Use	Description	Recommended Use	Format
OPEID	Optional choice	The unique identifier assigned by the Office of Postsecondary Education for each data exchange partner.	Recommended (use one)	minOcc 0 maxOcc 1 minLength 3 maxLength 8
Comment: The OPEID would only be appropriate if the course were taken at a postsecondary institution.				
NHELPIID	Optional choice	The unique identifier assigned by National Council on Higher Education Loan Programs for each data exchange partner.	Not Recommended	minOcc 0 maxOcc 1 minLength 3 maxLength 8
Comment: The NHELPIID is not an appropriate code to describe a school that offers academic courses.				
IPEDS	Optional choice	The unique identifier assigned by the National Center for Education Statistics for the Integrated Postsecondary Education Data System for each postsecondary data exchange partner.	Recommended (use one)	minOcc 0 maxOcc 1 minLength 6 maxLength 6
Comment: The IPEDS code set is not appropriate for indicating a high school that offers an academic course. However, if this override school is a postsecondary institution, then this is an appropriate choice.				
ATP	Optional choice	The unique identifier assigned for the Admissions Testing Program by the College Board for each postsecondary data exchange partner.	Recommended (use one)	minOcc 0 maxOcc 1 minLength 6 maxLength 6
Comment: The ATP code set is not appropriate for indicating a high school that offers an academic course, but if this override school is a postsecondary institution, then this is an appropriate choice.				
FICE	Optional choice	The unique identifier assigned for the Federal Interagency Committee on Education by the US Department of Education's National Center for Education Statistics for each postsecondary data exchange partner	Recommended (use one)	minOcc 0 maxOcc 1 minLength 6 maxLength 6
Comment: The FICE code set is not appropriate for indicating a high school that offers an academic course, but if this override school is a postsecondary institution, then this is an appropriate choice.				
ACT	Optional choice	The unique identifier assigned by the American College Testing or ACT for each postsecondary data exchange partner. See www.act.org.	Recommended (use one)	minOcc 0 maxOcc 1 minLength 4 maxLength 4
Comment: The ACT code set is not appropriate for indicating a high school that offers an academic course, but if this override school is a postsecondary institution, then this is an appropriate choice.				
CCD	Optional choice	The unique identifier assigned by the US Department of Education's National Center for Education Statistics as the Common Core of Data for each K12 data exchange partner.	Recommended (use one)	minOcc 0 maxOcc 1 minLength 12 maxLength 12
CEEBACT	Optional choice	The unique identifier assigned by the College Entrance Examining Board and ACT for each K12 data exchange partner.	Recommended (use one)	minOcc 0 maxOcc 1 minLength 6 maxLength 6
Comment: The CEEBACT code set is arguably the most common code for indicating a high school that offers academic courses.				
CSIS	Optional choice	The unique identifier assigned by the Statistics Canada Canadian College Student Information System for each data exchange partner	Recommended (use one)	minOcc 0 maxOcc 1 minLength 6 maxLength 6

Tag Name	Schema Use	Description	Recommended Use	Format
USIS	Optional choice	The unique identifier assigned by the Statistics Canada University Student Information System for each data exchange partner	Recommended (use one)	minOcc 0 maxOcc 1 minLength 6 maxLength 6
ESIS	Optional choice	The unique identifier assigned by the Statistics Canada Enhanced Student Information System for each data exchange partner.	Recommended (use one)	minOcc 0 maxOcc 1 minLength 8 maxLength 8
DUNS	Optional choice	Data Universal Numbering System (DUNS), unique nine character company identification number issued by Dun and Bradstreet Corporation.	Not Recommended	minOcc 0 maxOcc 1 minLength 9 maxLength 9
Comment: The DUNS code would not normally be an appropriate code set to use to indicate an academic institution.				
Comment: Although it is not necessary to send one of the above 12 codes, if you choose to do so, then choose one of the noted appropriate codes.				
LocalOrganizationID	Optional	A code set typically used by a state, province or region to further identify the school whose record is being sent	Optional	minOcc 0 maxOcc 1
Comment: This complex data element will be expanded on page XXX which follows.				
SchoolOverrideCode	Optional	The source of the academic credit if not awarded by the home or parent institution. <i>Institutional</i> - Institutional Agreement <i>Multicampus</i> - Multiple Campus Course Offering <i>Transfer</i> - Transfer Credit <i>StudyAbroad</i> - Study Abroad <i>Coop</i> - Cooperative Program <i>Reciprocal</i> - Reciprocal Exchange <i>Internship</i> - Internship	Recommended	minOcc 0 maxOcc 1 Enumerations: Institutional Multicampus Transfer StudyAbroad Coop Reciprocal Internship
SchoolLevel	Optional	Indicates level of Override School	Recommended	minOcc 0 maxOcc 1 Enumerations: Elementary Secondary Postsecondary
Contacts	Optional Repeatable	Contact info at Override School	Optional	minOcc 0 maxOcc ∞
Comment: The sending school would not normally have any information about contacts at the override school so this would not normally be included with the High School Transcript. This complex data element will be expanded on page XXX which follows.				
NoteMessage	Optional Repeatable	Additional information about the Override School	Not Recommended	minOcc 0 maxOcc ∞ minLength 1 maxLength 80

**Student.AcademicRecord.AcademicSession.Course.
CourseOverrideSchool (Continued)**

Code illustration:

```
<School>  
  <OrganizationName>Miami Dade School District; Miami Senior High School</OrganizationName>  
  <CEEBACT>101075</CEEBACT>  
  <LocalOrganizationID>  
  
  </LocalOrganizationID>  
  <SchoolOverrideCode>Reciprocal</SchoolOverrideCode>  
  <SchoolLevel>Secondary</SchoolLevel>  
  <Contacts>  
  
  </Contacts>  
  <Note/Message />  
</School>
```

**Student.AcademicRecord.AcademicSession.Course.
CourseOverrideSchool.LocalOrganizationID**

Note: Although the complex data element LocalOrganizationID is an optional data element, if you choose to send LocalOrganizationID, then you must also send both LocalOrganizationIDCode and also LocalOrganizationIDQualifier.

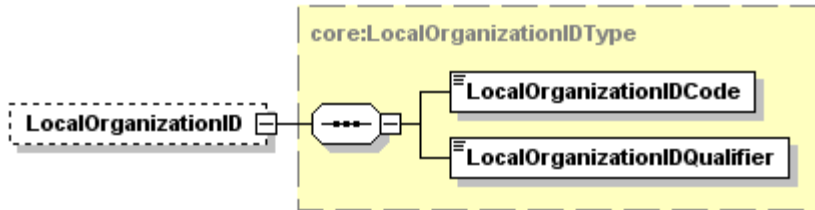

Tag Name	Schema Use	Description	Recommended Use	Format
LocalOrganizationIDCode	Required	The code assigned for the receiving school by the state, province or other mutually defined agency specified in the LocalOrganizationIDQualifier that follows.	Required	minOcc 1 maxOcc 1 minLength 1 maxLength 35
Comment: This is a required data element only if the LocalOrganizationID data element is sent. This is typically the administrative school code assigned by a state or province to specifically identify the receiving school in that state. If it is not assigned by a state or province, then code ZZ should be used in the Local ID Qualifier that follows.				
LocalOrganizationIDQualifier	Required	This is the state, province or other mutually defined agency that assigned the LocalOrganizationID Code above.	Required	minOcc 1 maxOcc 1 See Appendix A.
Comment: This is a required data element only if the LocalOrganizationID data element is sent. This is typically the state or province that assigned the code to specifically identify the receiving school in that state. If it is not assigned by a state or province, then code ZZ should be used in this data element				

Code illustration:

```
<LocalOrganizationID>
  <LocalOrganizationIDCode>340005501</LocalOrganizationIDCode>
  <LocalOrganizationIDQualifier>FL</LocalOrganizationIDQualifier>
</LocalOrganizationID>
```

**Student.AcademicRecord.AcademicSession.Course.
CourseOverrideSchool.Contacts**

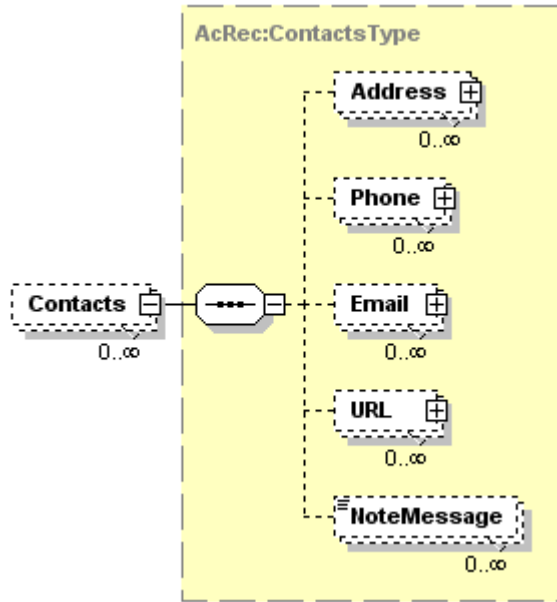

Tag Name	Schema Use	Description	Recommended Use	Format
Address	Optional Repeatabe	Address of the Override School	Recommended	minOcc 0 maxOcc ∞
<i>Comment: This complex data element will be expanded on page XXX which follows.</i>				
Phone	Optional Repeatabe	Phone Number of the Override School	Optional	minOcc 0 maxOcc ∞
<i>Comment: This complex data element will be expanded on page XXX which follows.</i>				
Email	Optional Repeatabe	Email Address of the Override School	Optional	minOcc 0 maxOcc ∞
<i>Comment: This complex data element will be expanded on page XXX which follows.</i>				
URL	Optional Repeatabe	Universal Resouce Locator of the Override School	Optional	minOcc 0 maxOcc ∞
<i>Comment: This complex data element will be expanded on page XXX which follows.</i>				
NoteMessage	Optional Repeatabe	Additional information about the contacts at the Override School	Not Recommended	minOcc 0 maxOcc ∞ minLength 1 maxLength 80

**Student.AcademicRecord.AcademicSession.Course.
CourseOverrideSchool.Contacts (Continued)**

Code illustration:

```
<Contacts>  
  <Address>  
  
    </Address>  
    <Phone>  
  
      </Phone>  
      <Email>  
  
        </Email>  
        <URL>  
  
          </URL>  
          <NoteMessage />  
</Contacts>
```

Student.AcademicRecord.AcademicSession.Course. CourseOverrideSchool.Contacts.Address

Note: Although the complex data element Address is an optional data element, if you choose to send the Address of the CourseOverrideSchool, then you must send AddressLine and City and also StateProvinceCode, and PostalCode OR CountryCode.

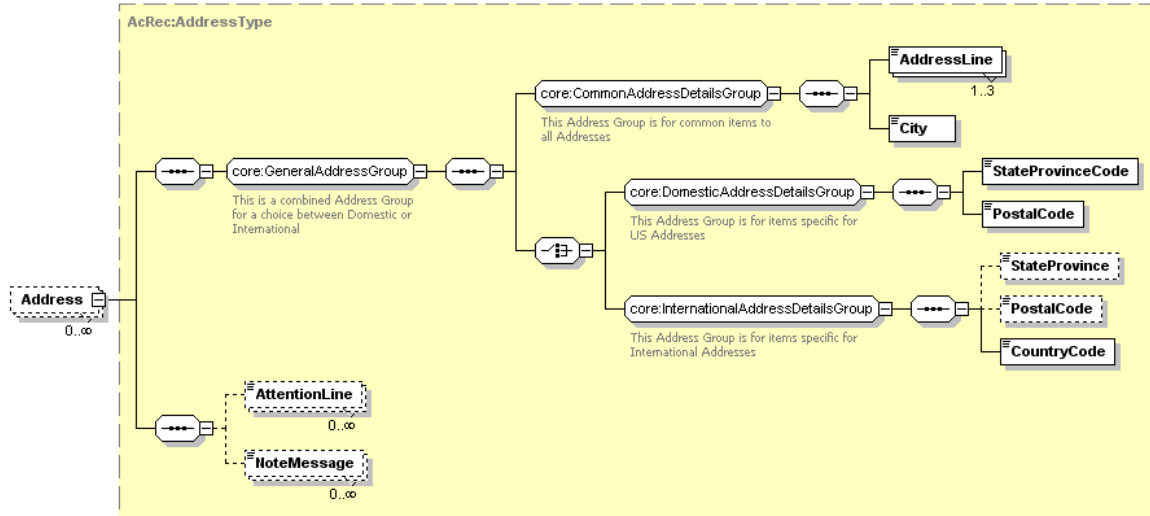

Tag Name	Schema Use	Description	Recommended Use	Format
<i>GeneralAddressGroup</i>	Required	This Address Group is for items common to all Addresses	Required	minOcc 1 maxOcc 1
Comment: [<i>GeneralAddressGroup</i>] does not appear in the instance document. It requires the use of <i>CommonAddressDetailsGroup</i> and the choice of one of either <i>DomesticAddressDetailsGroup</i> or <i>InternationalAddressDetailsGroup</i> . This group is required in the schema only if you choose to send the address of the contact.				
<i>CommonAddressDetailsGroup</i>	Required	This Address Group is for items common to all Addresses	Required	minOcc 1 maxOcc 1
Comment: [<i>CommonAddressDetailsGroup</i>] does not appear in the instance document. If the address of a contact is included in the transcript, then this must be sent. It is required and must be paired with one of either <i>DomesticAddressDetailsGroup</i> or <i>InternationalAddressDetailsGroup</i> .				
<i>AddressLine</i>	Required Repeatable	Local delivery information such as street, building number, PO box, or apartment portion of a postal address of a Contact at the Sending (Source) High School.	Required	minOcc 1 maxOcc 3 minLength 1 maxLength 40
<i>City</i>	Required	The city portion of the Address of a Contact at the Sending (Source) High School.	Required	minOcc 1 maxOcc 1 minLength 2 maxLength 30
<i>DomesticAddressDetailsGroup</i>	Required choice	This Address Group is for items specific for US and Canadian Addresses	Required for domestic addresses	minOcc 1 maxOcc 1
Comment: [<i>DomesticAddressDetailsGroup</i>] does not appear in the instance document. If the complex data element address has a United States or Canadian Postal Code and a US State or Canadian Province Code, then this should be the required choice.				

Tag Name	Schema Use	Description	Recommended Use	Format
StateProvinceCode	Required	Code for US states, etc., and Canadian provinces.	Required	minOcc 1 maxOcc 1 Enumeration: See Appendix A
PostalCode	Required	The postal code portion of the Address.	Required	minOcc 1 maxOcc 1 minLength 1 maxLength 17
<i>InternationalAddressDetailsGroup</i>	Required choice	This Address Group is for items specific for International Addresses	Required for international addresses	minOcc 1 maxOcc 1
Comment: [InternationalAddressDetailsGroup] does not appear in the instance document. This choice is for addresses that do not have a US or Canadian postal code.				
StateProvince	Optional	The literal name of the state, province or territory of a postal address of the source of this document. Use for addresses outside US or Canada.	Recommended Refer to common postal practices of the source country	minOcc 0 maxOcc 1 minLength 2 maxLength 30
Comment: For an internet resource of states or other geographical subdivisions in countries other than the US and Canada, you might choose to refer to the website of the Universal Postal Union at http://www.upu.int				
PostalCode	Optional	The postal code portion of the Address.	Recommended Refer to common postal practices of the source country	minOcc 0 maxOcc 1 minLength 1 maxLength 17
Comment: For an internet resource of states or other geographical subdivisions in countries other than the US and Canada, you might choose to refer to the website of the Universal Postal Union at http://www.upu.int				
CountryCode	Required	Code indicating Country. Use ISO 3166-1 alpha-2 standard.	Required	minOcc 1 maxOcc 1 Enumerations: See Appendix B
AttentionLine	Optional	The individual or office name within the postal address where inquiries should be directed.	Optional	minOcc 1 maxOcc ∞ minLength 1 maxLength 45
Comment: This might be used to indicate where questions about the record should be sent. For example, <i>Principal, Guidance Counselor, Headmaster, etc.</i>				
NoteMessage	Optional Repeatable	Additional information about the addresses of the contacts at the source school	Not recommended	minOcc 0 maxOcc ∞ minLength 1 maxLength 80

**Student.AcademicRecord.AcademicSession.Course.
CourseOverrideSchool.Contacts.Address (Continued)**

Code illustration 1 (Domestic Address):

```
<Address>  
  <AddressLine>1715 W Cesar Chavez</AddressLine>  
  <City>Austin</City>  
  <StateProvinceCode>TX</StateProvinceCode>  
  <PostalCode>78703</PostalCode>  
  <AttentionLine>Jane Doe</AttentionLine>  
    <AttentionLine>GuidanceCounselor</AttentionLine>  
  <NoteMessage />  
</Address>
```

Code illustration 2 (International Address):

```
<Address>  
  <AddressLine>Altova Corporation</AddressLine>  
  <AddressLine>Rudolfsplatz 13a/9</AddressLine>  
  <City>Wien</City>  
  <StateProvince />  
  <PostalCode>A-1010</PostalCode>  
  <CountryCode>AT</CountryCode>  
</Address>
```

**Student.AcademicRecord.AcademicSession.Course.
CourseOverrideSchool.Contacts.Phone**

Note: Although the complex data element Phone is an optional data element, if you choose to send the Phone of the Override School, then you must send the phone number.

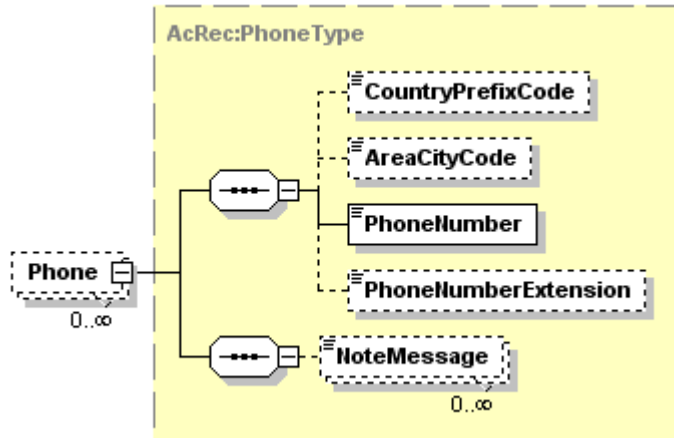

Tag Name	Schema Use	Description	Recommended Use	Format
CountryPrefixCode	Optional	International dialing code.	Optional	minOcc 0 maxOcc 1 minLength 1 maxLength 3
AreaCityCode	Optional	Regional dialing code.	Recommended	minOcc 0 maxOcc 1 minLength 1 maxLength 5
Comment: This is the 3 digit area code in the United States and Canada.				
PhoneNumber	Required	Telephone number.	Required	minOcc 1 maxOcc 1 minLength 1 maxLength 11
PhoneNumberExtension	Optional	The extended telephone addressing information used in addition to phone number such as a PBX extension, a pager PIN, or FAX sub-address.	Optional	minOcc 0 maxOcc 1 minLength 1 maxLength 5
NoteMessage	Optional Repeatable	Additional information about the phone number of the override school	Not recommended	minOcc 0 maxOcc ∞ minLength 1 maxLength 80
Comment: This is the phone of the Course Override School.				

Code illustration:

```
<Phone>
  <CountryPrefixCode />
  <AreaCityCode>512</AreaCityCode>
  <PhoneNumber>4757638</PhoneNumber>
  <PhoneNumberExtension/>
  <NoteMessage />
</Phone>
```

**Student.AcademicRecord.AcademicSession.Course.
CourseOverrideSchool.Contacts.Email**

Note: Although the complex data element Email is an optional data element, if you choose to send the Email of the Override School, then you must send the EmailAddress.

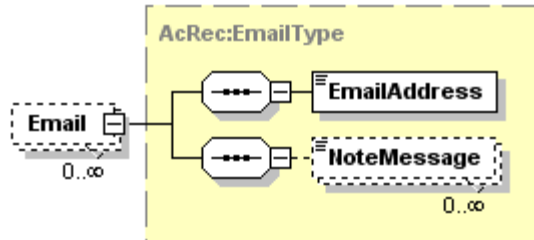

Tag Name	Schema Use	Description	Recommended Use	Format
EmailAddress	Required	The numbers, letters, and symbols used to identify an electronic mail (Email) user within a network.	Required	minOcc 1 maxOcc 1 minLength 1 maxLength 128
NoteMessage	Optional Repeatable	Additional information about the email address	Not recommended	minOcc 0 maxOcc ∞ minLength 1 maxLength 80

Comment: This is the Email of the Course Override School.

Code illustration:

```
<Email>
  <EmailAddress>registrar@newtrier.k12.il.us</EmailAddress>
  <NoteMessage />
</Email>
```

**Student.AcademicRecord.AcademicSession.Course.
CourseOverrideSchool.Contacts.URL**

Note: Although the complex data element URL is an optional data element, if you choose to send the URL of the Override School, then you must send the URLAddress.

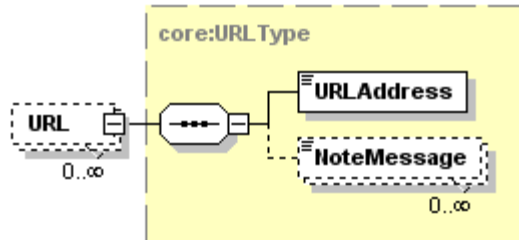

Tag Name	Schema Use	Description	Recommended Use	Format
URLAddress	Required	The Uniform Resource Locator (URL) address associated with a product, deliverable or contact.	Required	minOcc 1 maxOcc 1 minLength 0 maxLength 512
NoteMessage	Optional Repeatable	Additional information about the URL	Not Recommended	minOcc 0 maxOcc ∞ minLength 1 maxLength 80

Comment: This is the URL of the Course Override School.

Code illustration:

```
<URL>
  <URLAddress>http://nths.newtrier.k12.il.us</URLAddress>
  <NoteMessage />
</URL>
```

Student.AcademicRecord.AcademicSession.Course.Requirement

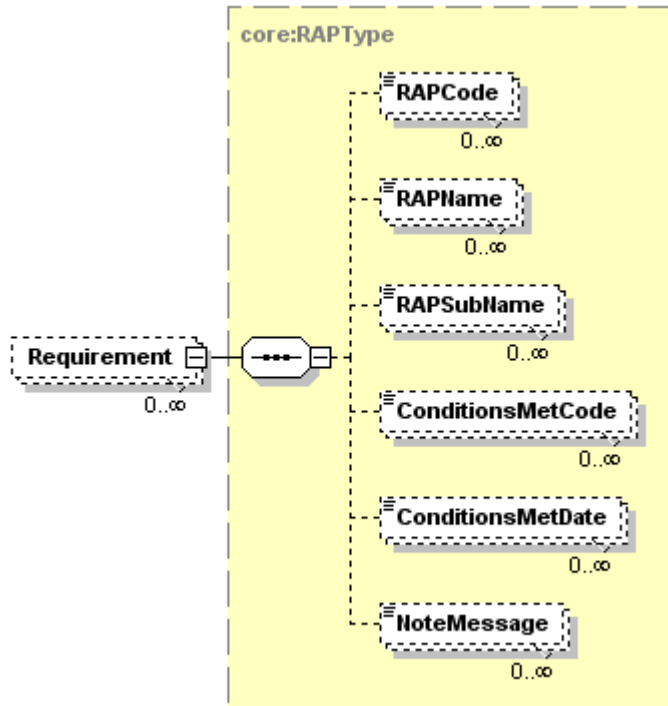

Tag Name	Schema Use	Description	Recommended Use	Format
RAPCode	Optional Repeatable	Requirement demonstrated or earned in addition to or as part of an academic award.	Recommended	minOcc 0 maxOcc ∞ minLength 1 maxLength 3
Comment: If this data element is to be used effectively, a code set should be created by a state or region. An example is given below in the Code Illustration. If not, then User Defined Extensions would be an alternate method of including this information.				
RAPName	Optional Repeatable	Literal name of requirement	Recommended	minOcc 0 maxOcc ∞ minLength 1 maxLength 60
RAPSubName	Optional Repeatable	Literal name of subsection of requirement	Optional	minOcc 0 maxOcc ∞ minLength 1 maxLength 60
ConditionsMetCode	Optional Repeatable	Indicates whether and how conditions for the requirement have been attained.	Recommended	minOcc 0 maxOcc ∞ Enumerations: Yes No Conditional MutuallyDefined
ConditionsMetDate	Optional Repeatable	Date requirement was met.	Optional	minOcc 0 maxOcc ∞ xs:date
Comment: The format of date is cyy-mm-dd.				

Tag Name	Schema Use	Description	Recommended Use	Format
NoteMessage	Optional Repeatable	Additional information about the requirement	Not Recommended	minOcc 0 maxOcc ∞ minLength 1 maxLength 80

Comment: For example, the Requirement part of the course could be used to indicate that completion of this course satisfies a computer literacy requirement for graduation or a Community Service requirement. It could also be use to indicate that this course meets a requirement for admission to the state university system.

Code illustration:

```

<Requirement>
  <RAPCode>9TX</RAPCode>
  <RAPName>TXDegReq</RAPName>
  <RAPSubName>UT Austin Writing Component</RAPSubName>
  <ConditionsMetCode>Yes</ConditionsMetCode>
  <ConditionsMetDate>2002-08-13</ConditionsMetDate>
  <NoteMessage />
</Requirement>
    
```

Student.AcademicRecord.AcademicSession.Course.Attribute

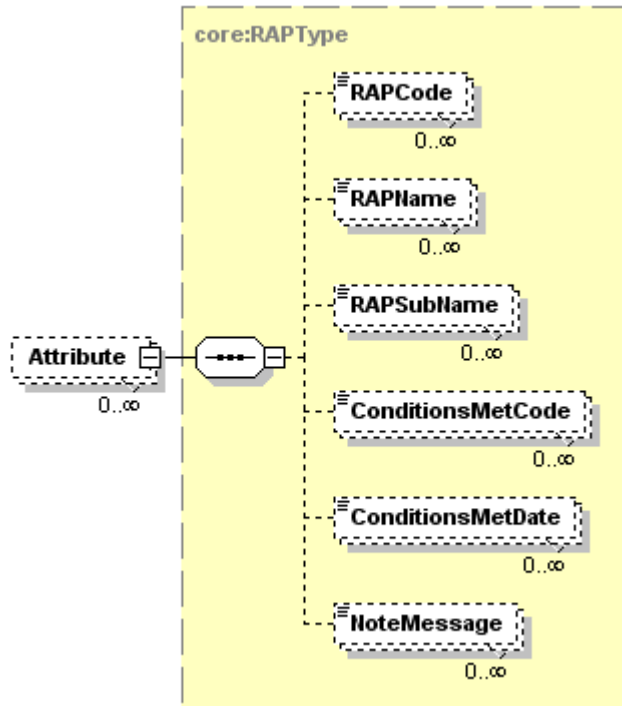

Tag Name	Schema Use	Description	Recommended Use	Format
RAPCode	Optional Repeatable	Attribute demonstrated or earned in addition to academic award.	Recommended	minOcc 0 maxOcc ∞ minLength 1 maxLength 3
Comment: If this data element is to be used effectively, a code set should be created by a state or region. An example is given below in the Code Illustration. If not, then User Defined Extensions would be an alternate method of including this information.				
RAPName	Optional Repeatable	Literal name of attribute	Recommended	minOcc 0 maxOcc ∞ minLength 1 maxLength 60
RAPSubName	Optional Repeatable	Literal name of subsection of attribute	Optional	minOcc 0 maxOcc ∞ minLength 1 maxLength 60
ConditionsMetCode	Optional Repeatable	Indicates whether and how conditions for certification have been attained.	Recommended	minOcc 0 maxOcc ∞ Enumeration: Yes No Conditional MutuallyDefined
ConditionsMetDate	Optional Repeatable	Date of meeting the attribute	Optional	minOcc 0 maxOcc ∞ xs: date
Comment: The format for date is ccyymm-dd.				

Tag Name	Schema Use	Description	Recommended Use	Format
NoteMessage	Optional Repeatable	Additional information about the attribute	Not Recommended	minOcc 0 maxOcc ∞ minLength 1 maxLength 80

Comment: For example, the Attribute part of the course could be used to indicate that the course was taught by a university professor, or it was taught in a hands-on computer lab, etc. It would normally only have significant meaning when used by all participating schools within a state or region.

Code illustration:

```

<Attribute>
  <RAPCode>9TX</RAPCode>
  <RAPName>TXCORECURR</RAPName>
  <RAPSubName>020Mathematics (I)</RAPSubName>
  <ConditionsMetCode>Yes</ConditionsMetCode>
  <ConditionsMetDate>1997-03-01</ConditionsMetDate>
  <NoteMessage />
</Attribute>
    
```

Student.AcademicRecord.AcademicSession.Course.Proficiency

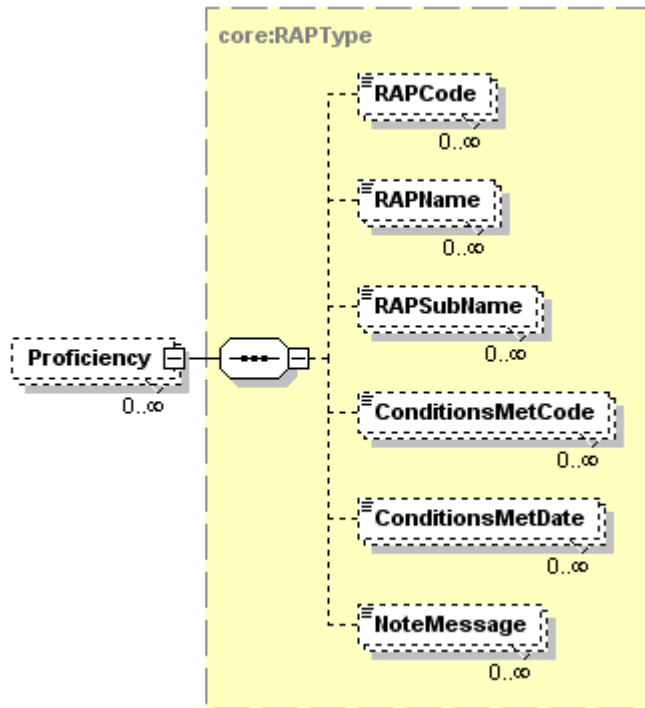

Tag Name	Schema Use	Description	Recommended Use	Format
RAPCode	Optional Repeatable	Proficiency demonstrated or earned in addition to academic award.	Recommended	minOcc 0 maxOcc ∞ minLength 1 maxLength 3
Comment: If this data element is to be used effectively, a code set should be created by a state or region. An example is given below in the Code Illustration. If not, then User Defined Extensions would be an alternate method of including this information.				
RAPName	Optional Repeatable	Literal name of proficiency	Recommended	minOcc 0 maxOcc ∞ minLength 1 maxLength 60
RAPSubName	Optional Repeatable	Literal name of subsection of proficiency	Optional	minOcc 0 maxOcc ∞ minLength 1 maxLength 60
ConditionsMetCode	Optional Repeatable	Indicates whether and how conditions for certification have been attained.	Recommended	minOcc 0 maxOcc ∞ Enumerations: Yes No Conditional MutuallyDefined
ConditionsMetDate	Optional Repeatable	Date of proficiency	Optional	minOcc 0 maxOcc ∞ xs:date
Comment: The format for date is ccyy-mm-dd.				

Tag Name	Schema Use	Description	Recommended Use	Format
NoteMessage	Optional Repeatable	Additional information about the proficiency	Not Recommended	minOcc 0 maxOcc ∞ minLength 1 maxLength 80

Comment: For example, the Proficiency part of the course could be used to indicate successful completion of this course demonstrates a school graduation requirement for computer competency or English proficiency.

Code illustration:

```

<Proficiency>
  <RAPCode>9TX</RAPCode>
  <RAPName>Computer Literacy Proficiency</RAPName>
  <RAPSubName>CSPROF - ComputerSkillsProficiency</RAPSubName>
  <ConditionsMetCode>Yes</ConditionsMetCode>
  <ConditionsMetDate>2004-10-23</ConditionsMetDate>
  <NoteMessage>Students learn MS Word, PPT and Web Search in this course.</NoteMessage>
</Proficiency>
    
```

Student.AcademicRecord.AcademicSession.Course.Licensure

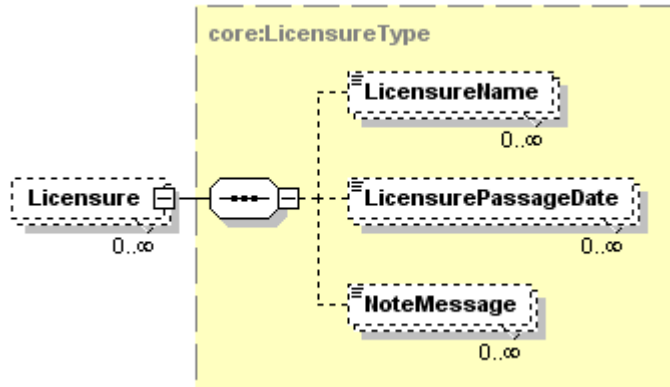

Tag Name	Schema Use	Description	Recommended Use	Format
LicensureName	Optional Repeatable	Free-form name of license or certification.	Recommended	minOcc 0 maxOcc ∞ minLength 1 maxLength 60
LicensurePassageDate	Optional Repeatable	Date of licensure passage	Optional	minOcc 0 maxOcc ∞ xs:date
Comment: The format for date is ccyy-mm-dd.				
NoteMessage	Optional Repeatable	Additional information about the licensure	Not Recommended	minOcc 0 maxOcc ∞ minLength 1 maxLength 80

Code illustration:

```

<Licensure>
  <LicensureName>Occupational Therapy Assistant</LicensureName>
  <LicensurePassageDate>2004-05-20</LicensurePassageDate>
  <NoteMessage />
</Licensure>
    
```

**Student.AcademicRecord.AcademicSession.Course.
LanguageOfInstruction**

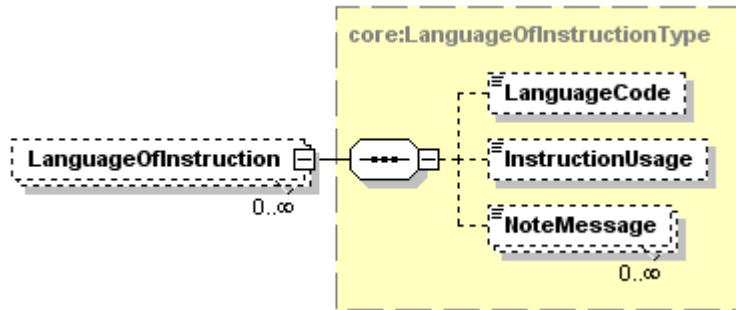

Tag Name	Schema Use	Description	Recommended Use	Format
LanguageCode	Optional	Code indicating the language being used, using ISO 639-2 code (Alpha-3) set. These codes are available at http://www.loc.gov/standards/iso639-2/	Recommended	minOcc 0 maxOcc 1 minLength 3 maxLength 3
InstructionUsage	Optional	The use of the language in the context of instruction. <i>Instruction</i> - Language of Instruction <i>Examination</i> - Language of Examination <i>WrittenExam</i> - Language in which Examination is written	Recommended	minOcc 0 maxOcc 1 Enumeration: Instruction Examination WrittenExam
NoteMessage	Optional Repeatable	Additional information about the language of instruction	Not Recommended	minOcc 0 maxOcc ∞ minLength 1 maxLength 80

Comment: This is an optional data element. If it is not included, it is assumed the language of instruction was English if the high school sending the record is in the United States.

Code illustration:

```
<LanguageOfInstruction>
  <LanguageCode>fre</LanguageCode>
  <InstructionUsage>Instruction</InstructionUsage>
  <NoteMessage />
</LanguageOfInstruction>
```

Student.AcademicRecord.AcademicSession.AcademicSummary

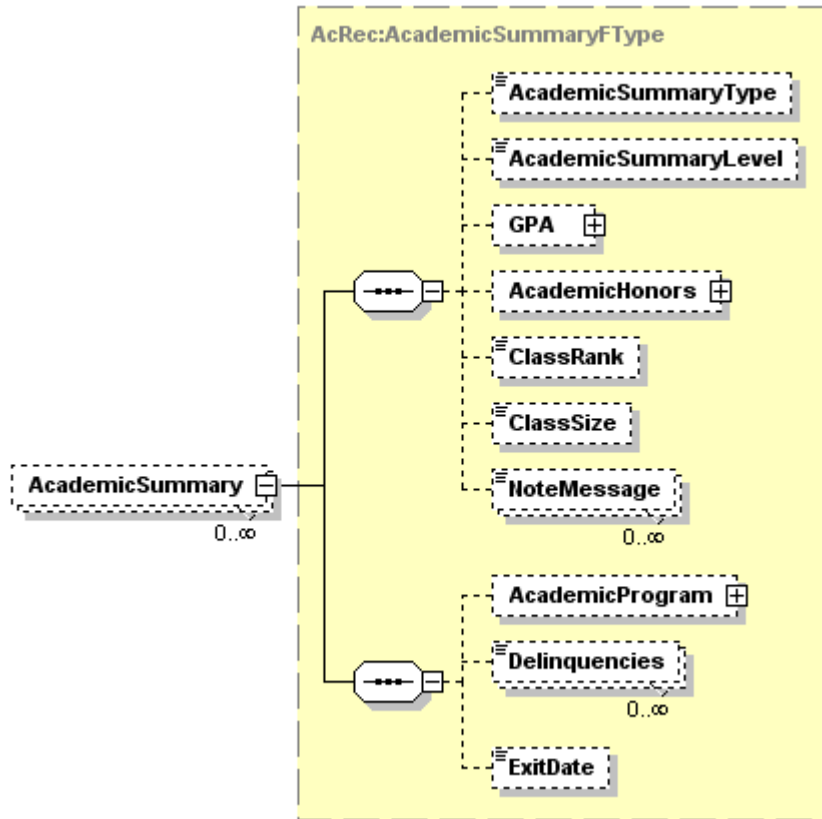

Tag Name	Schema Use	Description	Recommended Use	Format
AcademicSummaryType	Optional	<p>Summary Type is an indication of what is being summarized over what period of time</p> <p><i>All</i> - Summary of all courses regardless of institution</p> <p><i>SenderOnly</i> - Summary of all courses at sending institution (or recorded as if they were taken at the sending institution)</p> <p><i>TransferOnly</i> - Summary of transfer work (courses taken at other than the sending institution)</p> <p><i>AllNotRepeated</i> - Summary of all courses except for repeated or forgiven courses/credits</p> <p><i>SenderNotRepeated</i> - Summary of all courses at sending institution except for repeated or forgiven courses/credits</p> <p><i>TransferNotRepeated</i> - Summary of transfer work except for repeated or forgiven courses/credits</p> <p><i>AcademicRenewal</i> - Subset of forgiven courses</p> <p><i>CarryoverCredit</i> - Summary from offline records and used as the initial point for cumulatives and averages</p> <p><i>DegreeApplicable</i> - Summary of courses that apply to degree</p>	Recommended	<p>minOcc 0 maxOcc 1</p> <p>Enumerations: All SenderOnly TransferOnly AllNotRepeated SenderNotRepeated TransferNotRepeated AcademicRenewal CarryoverCredit DegreeApplicable NonDegreeApplicable ConvertedFrom ConvertedTo UserDefined Weighted NonWeighted</p>

Tag Name	Schema Use	Description	Recommended Use	Format
		<p><i>NonDegreeApplicable</i> - Summary of courses that do not apply toward degree</p> <p><i>ConvertedFrom</i> - Summary of credits before an institutional term-basis conversion, such as from quarters to semesters</p> <p><i>ConvertedTo</i> - Summary of credits after an institutional term-basis conversion, such as from quarters to semesters</p> <p><i>UserDefined</i> - see NoteMessage for explanation</p> <p><i>Weighted</i> - Summary that gives additional (higher) value to specific courses taken by a student, such as honors courses, International Baccalaureate, Advanced Placement, high school /college dual enrollment.</p> <p><i>NonWeighted</i> - Summary that does not give additional value to courses, regardless of special characteristics of the courses. For example, if the grading scale is from 0 to 4.00, then it is not possible to have a summary higher than 4.00.</p>		
AcademicSummaryLevel	Optional	The level of credit associated with the credit hours earned for the course.	Not Recommended	minOcc 0 maxOcc 1 Enumeration: Undergraduate LowerDivision UpperDivision Vocational TechnicalPreparatory Graduate Professional Dual GraduateProfessional
Comment: These enumerated values are not appropriate for the high school transcript.				
GPA	Optional	GPA for this academic summary	Recommended	minOcc 0 maxOcc 1
Comment: This complex data element will be expanded on page XXX which follows.				
AcademicHonors	Optional	Honors associated with this academic summary	Optional	minOcc 0 maxOcc 1
Comment: This complex data element will be expanded on page XXX which follows.				
Comment: This would typically be where honors awarded during or at the end of a session, like Honor Roll, are included.				
ClassRank	Optional	The student's class rank relative to other students in their academic cohort (e.g. class).	Not Recommended	minOcc 0 maxOcc 1 minInclusive 1 maxInclusive 9999 totalDigits 4
Comment: The Workgroup that developed this PESC XML High School Transcript Schema recommends that this is not the most appropriate place for inclusion of the student's overall rank in class. If it is included in the Schema, it is recommended that a more appropriate place be under Student.AcademicRecord.AcademicSummary. The student ranking the highest in the class would have a rank of "1".				

Tag Name	Schema Use	Description	Recommended Use	Format
ClassSize	Optional	The numeric size of the academic cohort (e.g. class).	Not Recommended	minOcc 0 maxOcc 1 minInclusive 1 maxInclusive 9999 totalDigits 4
Comment: If there were 753 students in the student's class and if they were ranked by the high school, then this value would be "753".				
NoteMessage	Optional Repeatable	Additional information about the academic summary	Not Recommended	minOcc 0 maxOcc ∞ minLength 1 maxLength 80
Comment: If the class rank and class size are included in the transcript, then this note message could be used to indicate the cohort and/or date of the ranking.				
AcademicProgram	Optional	Academic program (major) associated with this academic summary	Optional	minOcc 0 maxOcc 1
Comment: This complex data element will be expanded on page XXX which follows.				
Comment: Information about the high school academic program is not normally included on a high school transcript.				
Delinquencies	Optional Repeatable	The academic standing of the student at the end of this session. <i>GoodStanding</i> - Student was in good standing <i>ProbationGPA</i> - Student was on academic probation (because of low GPA) <i>ProbationHours</i> - Student was on academic probation (deficiency in credit hours) <i>SuspensionGPA</i> - Student was on academic suspension (because of low GPA) <i>SuspensionHours</i> - Student was on academic suspension (deficiency in credit hours) <i>ProbationDiscipline</i> - Student was on disciplinary probation. Not recommended to be included on the high school transcript <i>SuspensionDiscipline</i> - Student was on disciplinary suspension. Not recommended to be included on the high school transcript <i>Unknown</i> <i>Other</i>	Optional	minOcc 0 maxOcc ∞ Enumeration: GoodStanding ProbationGPA ProbationHours SuspensionGPA SuspensionHours ProbationDiscipline SuspensionDiscipline Unknown Other
ExitDate	Optional	The date on which the student officially withdrew or graduated.	Optional	minOcc 0 maxOcc 1
Comment: This date would typically be the date of graduation for students who did graduate this session. If the student did not graduate, it would be the last date of known attendance. The date format is ccyy-mm-dd. It would not typically be included on the high school transcript except for the final session the student attended at that school.				

**Student.AcademicRecord.AcademicSession.AcademicSummary
(Continued)**

Code illustration:

```
<AcademicSummary>
  <AcademicSummaryType>All</AcademicSummaryType>
  <AcademicSummaryLevel/>
  <GPA>

  </GPA>
  <AcademicHonors>

  </AcademicHonors>
  <ClassRank>43</ClassRank>
  <ClassSize>849</ClassSize>
  <NoteMessage>Class ranking was of all juniors at end of junior year.</NoteMessage>
  <AcademicProgram>

  </AcademicProgram>
  <Delinquencies>GoodStanding</Delinquencies>
  <ExitDate>2005-05-13</ExitDate>
</AcademicSummary>
```

Student.AcademicRecord.AcademicSession.AcademicSummary.GPA

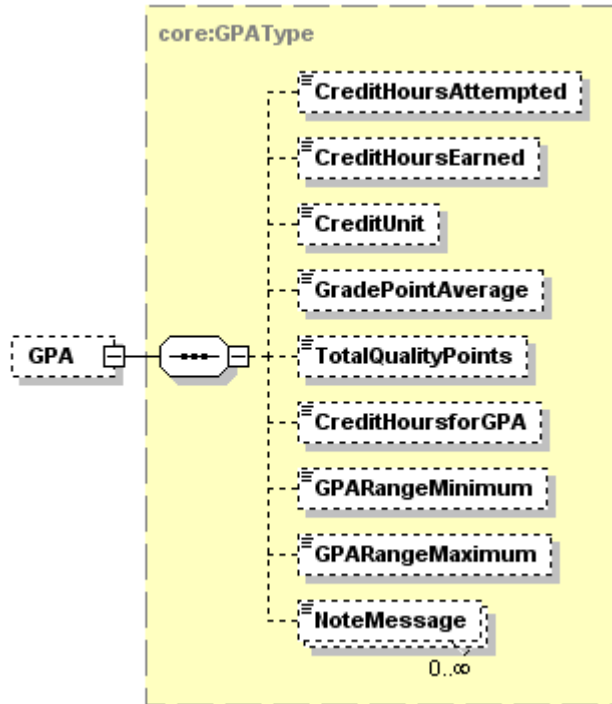

Tag Name	Schema Use	Description	Recommended Use	Format
CreditHoursAttempted	Optional	The total value of credit hours attempted whether or not included in the hours for GPA or hours earned.	Recommended	minOcc 0 maxOcc 1 xs:decimal
<p>Comment: This would also include the credit value of a course from which the student withdrew, if it appears on the transcript. So if a student had enrolled in 10 Carnegie Units which are all included in this session and appear on the transcript, and had passed 5 units and withdrawn from 5 units, then the value of this field would be "10". If the student had enrolled for 10.5 units that are included in this session on the transcript, then the value of this field would be "10.5".</p>				
CreditHoursEarned	Optional	The total value of credit hours successfully completed or earned.	Recommended	minOcc 0 maxOcc 1 xs:decimal
<p>Comment: If the student had earned 5 Carnegie Units and they all are included in this session on the transcript, then the value of this data element would be "5". If only 4.5 units were earned, then the value would be "4.5".</p>				
CreditUnit	Optional	The type of credit (unit, semester, or quarter) associated with the credit hours earned for the course.	Recommended	minOcc 0 maxOcc 1 Enumerations: NoCredit Quarter Semester Units ClockHours CarnegieUnits ContinuingEducationUnits Unreported Other

Tag Name	Schema Use	Description	Recommended Use	Format
GradePointAverage	Optional	The value of the total quality points divided by the Credit Hours for Grade Point Average.	Recommended	minOcc 0 maxOcc 1 xs:decimal
Comment: For example, if the student had enrolled for 10 Carnegie Units, passed 8 units with grades of B worth 3 quality points for each Carnegie Unit, and 2 Carnegie Units with grades of F worth 0 quality points, then the calculation would be 24 quality points divided by 10 or a GPA of "2.4" or "2.40" or "2.400" depending on the policy of the sending school.				
TotalQualityPoints	Optional	The total value of quality points used for the calculation of the Grade Point Average.	Recommended	minOcc 0 maxOcc 1 xs:decimal
Comment: If a student earned all grades of B (worth 3 quality points for each Carnegie Unit) in 8.5 Carnegie Units this session, then the value of this data element would be "25.5".				
CreditHoursforGPA	Optional	The total value of credit hours used to calculate the Grade Point Average.	Recommended	minOcc 0 maxOcc 1 xs:decimal
Comment: If a student earned grades of A (worth 4 quality points per unit) in 3 Carnegie Units, grades of F (worth 0 quality points per unit) in 4 units; and withdrew from 5 units, then the total credit hours for GPA would be "7".				
GPARangeMinimum	Optional	The minimum possible GPA	Recommended	minOcc 0 maxOcc 1 xs:decimal
Comment: If the lowest possible grade is an F and a grade of F is valued at 0 quality points, then this value would be "0", or "0.0" or "0.00".				
GPARangeMaximum	Optional	The maximum possible GPA	Recommended	minOcc 0 maxOcc 1 xs:decimal
Comment: If the highest possible grade is an A and a grade of A is valued at 4 quality points, then this value would be "4" or "4.0" or "4.00", etc.				
NoteMessage	Optional Repeatable	Additional information about the GPA	Not Recommended	minOcc 0 maxOcc ∞ minLength 1 maxLength 80
Comment: The GPA included at this point in the Schema represents the GPA for this session.				

Code illustration:

```

<GPA>
  <CreditHoursAttempted>4.5</CreditHoursAttempted>
  <CreditHoursEarned>4</CreditHoursEarned>
  <CreditUnit>CarnegieUnits</CreditUnit>
  <GradePointAverage>4.0</GradePointAverage>
  <TotalQualityPoints>16</TotalQualityPoints>
  <CreditHoursforGPA>4</CreditHoursforGPA>
  <NoteMessage />
</GPA>
    
```

Student.AcademicRecord.AcademicSession.AcademicSummary.AcademicHonors

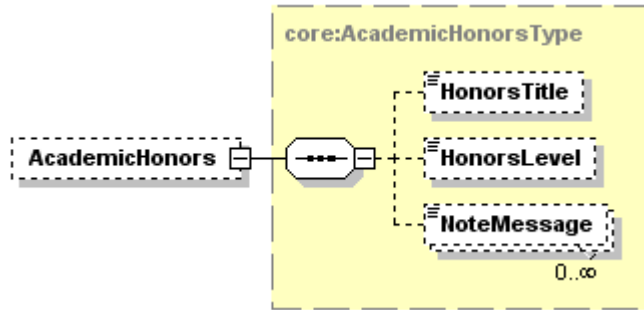

Tag Name	Schema Use	Description	Recommended Use	Format
HonorsTitle	Optional	The descriptive title for the honors received.	Recommended	minOcc 0 maxOcc 1 minLength 1 maxLength 30
<p>Comment: A variety of names are used for these session honors in the United States. Some common ones are "Principal's List", "Legion of Honor", "Honor Roll", "Dean's List", "Academic Achievement", etc.</p>				
HonorsLevel	Optional	A code value representing 1st highest honor, 2nd highest and 3rd highest.	Recommended	minOcc 0 maxOcc 1 Enumerations: FirstHighest SecondHighest ThirdHighest
<p>Comment: Honors Level is critical to understanding the context of Honors Title. In the examples shown for Honors Title above, it might be indicated that "Legion of Honor" is the First Highest honor possible, while "Academic Achievement" is the Third Highest honor available to be awarded a student at the end of a session.</p>				
NoteMessage	Optional Repeatable	Additional information about the honors	Not Recommended	minOcc 0 maxOcc ∞ minLength 1 maxLength 80

Code illustration:

```
<AcademicHonors>
  <HonorsTitle>Academic Achievement</HonorsTitle>
  <HonorsLevel>ThirdHighest</HonorsLevel>
  <NoteMessage />
</AcademicHonors>
```

Student.AcademicRecord.AcademicSession.AcademicSummary.AcademicProgram

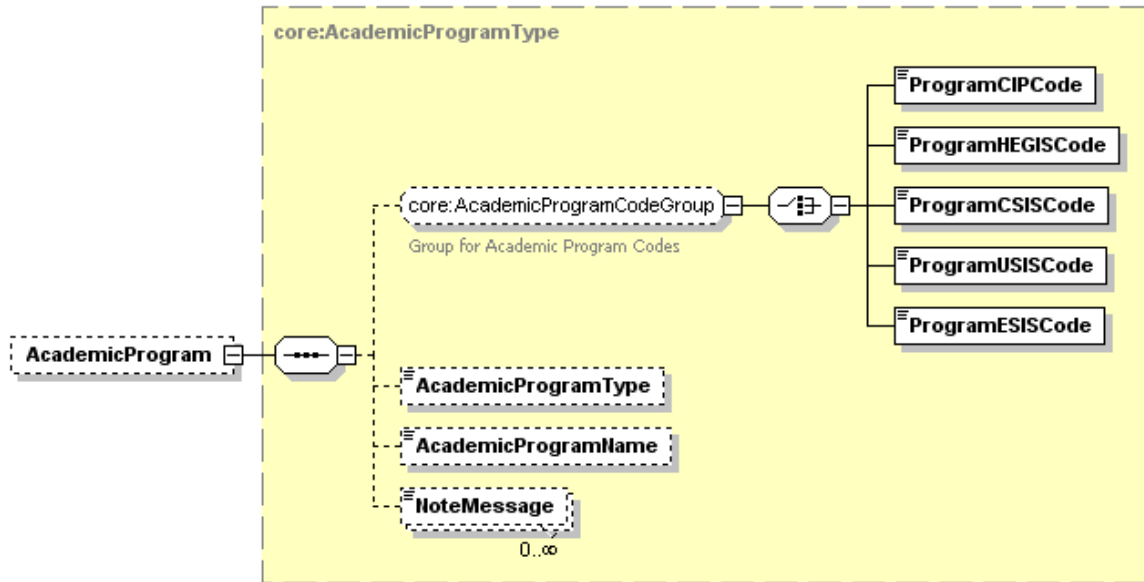

Tag Name	Schema Use	Description	Recommended Use	Format
ProgramCIPCode	Optional exclusive choice	Code indicating a discipline or field of study assigned by the Classification of Instructional Programs	Not Recommended	minOcc 0 maxOcc 1 minLength 6 maxLength 20
ProgramHEGISCode	Optional exclusive choice	Code indicating a discipline or field of study assigned by Higher Education General Information Survey	Not Recommended	minOcc 0 maxOcc 1 minLength 6 maxLength 20
ProgramCSISCode	Optional exclusive choice	Code indicating a discipline or field of study assigned by Statistics Canada Canadian College Student Information System	Not Recommended	minOcc 0 maxOcc 1 minLength 5 maxLength 5
ProgramUSISCode	Optional exclusive choice	Code indicating a discipline or field of study assigned by the Statistics Canada University Student Information System.	Not Recommended	minOcc 0 maxOcc 1 minLength 5 maxLength 5
ProgramESISCode	Optional exclusive choice	Code indicating a discipline or field of study assigned by the Statistics Canada Enhanced Student Information System.	Not Recommended	minOcc 0 maxOcc 1 minLength 1 maxLength 20
Comment: Although the Academic Program Code group is optional, if it is included then you must send one and only one of the above codes. None of the above code sets is appropriate to describe high school academic programs in the United States.				
AcademicProgramType	Optional	Indicates whether the academic program is a major, minor, area of concentration or specialization.	Optional	minOcc 0 maxOcc 1 Enumerations: Concentration Major Minor Specialization
AcademicProgramName	Optional	Literal name of program, major, or field of study.	Recommended	minOcc 0 maxOcc 1 minLength 1 maxLength 60

Tag Name	Schema Use	Description	Recommended Use	Format
NoteMessage	Optional Repeatable	Additional information about the Academic Program	Not Recommended	minOcc 0 maxOcc ∞ minLength 1 maxLength 80

Comment: This entire portion of the schema which describes a student's high school academic program is not normally included in a high school transcript.

Code illustration:

```

<AcademicProgram>
  <ProgramCIPCode />
  <AcademicProgramType>Major</AcademicProgramType>
  <AcademicProgramName>Math and Science Magnet</AcademicProgramName>
  <NoteMessage />
</AcademicProgram>
    
```

Student.AcademicRecord.Course

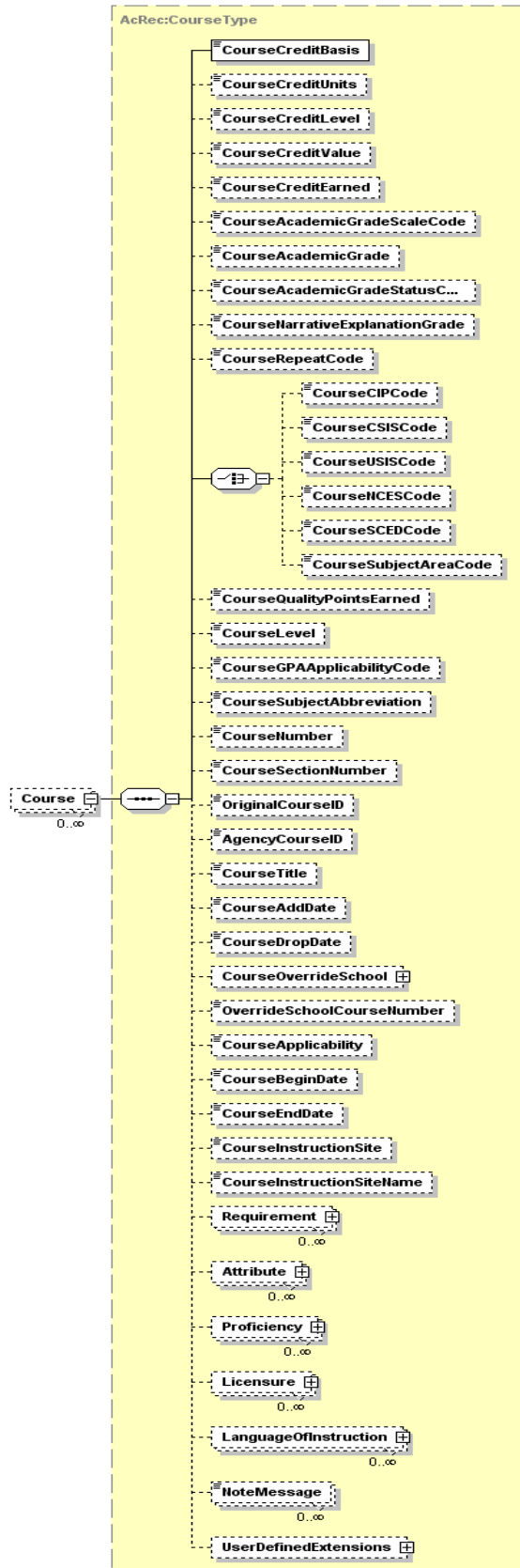

Tag Name	Schema Use	Description	Recommended Use	Format
CourseCreditBasis	Required	The type of enrollment associated with the credit hours for the course.	Required	minOcc 1 maxOcc 1 Enumerations: Regular AcademicRenewal AdvancedPlacement AdvancedStanding ContinuingEducation Exemption Equivalence InternationalBaccalaureate Military Remedial CreditByExam HighSchoolTransferCredit HighSchoolCreditOnly HighSchoolDualCredit JuniorHighSchoolCredit
CourseCreditUnits	Optional	The type of credit (unit, semester, or quarter) associated with the credit hours earned for the course.	Recommended	minOcc 0 maxOcc 1 Enumerations: NoCredit Quarter Semester Units ClockHours CarnegieUnits ContinuingEducationUnits Unreported Other
CourseCreditLevel	Optional	The level of credit associated with the credit hours earned for the course.	Not Recommended	minOcc 0 maxOcc 1 Enumerations: Undergraduate LowerDivision UpperDivision Vocational TechnicalPreparatory Graduate Professional Dual GraduateProfessional
Comment: These values are not appropriate for the high school transcript and should not be used.				
CourseCreditValue	Optional	Number indicating the credit hours that may be earned in the course.	Recommended	minOcc 0 maxOcc 1 xs:decimal
Comment: For example, if the course is worth 1 Carnegie Unit, and if the student withdrew from the course, but the course still appears on the high school transcript, then the value of this field is "1". Since it is a decimal field, it could also have a value of "1.0" or "1.00".				
CourseCreditEarned	Optional	The number of credits a student earns by the successful completion of a course.	Recommended	minOcc 0 maxOcc 1 xs:decimal
Comment: For example, if the course is worth 1 Carnegie Unit, and if the student passed the courset, then the value of this field is "1". Since it is a decimal field, it could also have a value of "1.0" or "1.00".				

Tag Name	Schema Use	Description	Recommended Use	Format
CourseAcademicGradeScaleCode	Optional	The grading scale used by an academic educational institution for an academic course.	Recommended	minOcc 0 maxOcc 1 See Appendix E
Comment: Grade scale is based on the American Medical Colleges Admissions Services (AMCAS) grade scale, values 01 through 99. See Appendix E for a complete list of code values.				
CourseAcademicGrade	Optional	The final grade awarded for participation in the course.	Recommended	minOcc 0 maxOcc 1 minLength 1 maxLength 10
CourseAcademicGradeStatusCode	Optional	Special enrollment or completion status of this course	Recommended	minOcc 0 maxOcc 1 Enumerations: AuditedCourse HonorsGrade Incomplete IncompleteNotResolvedFail InProgress NotYetReported OtherFailGrade OtherPassGrade PassFailFail PassFailPass TransferNoGrade Withdrew WithdrewFailing WithdrewNoPenalty WithdrewPassing
Comment: For crosswalk purposes from and to the ANSI ASC X12 EDI transaction, the equivalents are 500 – InProgress; 501 – PassFailPass; 502 – PassFailFail; 503 – CreditByExam; 504 – TransferNoGrade; 505 – Incomplete; 506 – WithdrewNoPenalty; 507 – WithdrewPassing; 509 – WithdrewFailing; 510 – HonorsGrade; 511 – AuditedCourse; 512 – Exempted; 513 – NotYetReported; 514 – IncompleteNotResolvedFail; 530 – OtherPassGrade; 531 – OtherFailGrade.				
CourseNarrativeExplanationGrade	Optional	The narrative of the grade awarded to a student in an academic course in those cases where a course does not receive a letter or numeric grade included in the grading scale of the Course Academic Grade Qualifier.	Not Recommended	minOcc 0 maxOcc 1 minLength 1 maxLength 200
CourseRepeatCode	Optional	Indicates that an academic course has been repeated by a student and how that repeat is to be computed in the student's academic grade average.	Recommended	minOcc 0 maxOcc 1 Enumerations: RepeatCounted RepeatNotCounted ReplacementCounted ReplacedNotCounted RepeatOtherInstitution NotCountedOther
Comment: If the sending high school has no policy on how to treat repeated courses, then this data element can be ignored by the sending high school. Likewise, if the receiving school has no policy or has a policy to ignore repeat calculations, then it can also be ignored. But if the sending school has such a policy, then this is the place to indicate that policy. For example, if the student previously took the same course, received a failing grade and has now completed this course with a passing grade, then the appropriate value might be "ReplacementCounted". Likewise, if this is the first attempt of the course, then this value might be "RepeatNotCounted".				
CourseCIPCode	Optional Choice	The Classification of Instructional Programs (CIP) code to describe the area of study for the course.	Not Recommended	minOcc 0 maxOcc 1 minLength 1 maxLength 10
CourseCSISCode	Optional Choice	The Statistics Canada Canadian College Student Information System (CCSIS) code to describe the area of study for the course.	Not Recommended	minOcc 0 maxOcc 1 minLength 1 maxLength 10

Tag Name	Schema Use	Description	Recommended Use	Format
CourseUSISCode	Optional Choice	The Statistics Canada University Student Information System (USIS) code to describe the area of study for the course.	Not Recommended	minOcc 0 maxOcc 1 minLength 1 maxLength 10
CourseNCESCode	Optional Choice	The code set developed (or being developed by the United States Department of Education's National Center for Education Statistics	Optional (use one)	minOcc 0 maxOcc 1 minLength 1 maxLength 10
CourseSCEDCode	Optional Choice	The School Codes for the Exchange of Data (SCED) code set being developed for the United States Department of Education's National Center for Education Statistics to describe the content and level of a course	Optional (use one)	minOcc 0 maxOcc 1 minLength 12 maxLength 12

Comment: This is a code set that is structured as follows:
 Digits 1, 2: This is the major subject area of course content in the high school course. Its breakdown is shown as the next data element (CourseSubjectAreaCode) which follows.
 Digits 3-5: A further breakdown of the course content in the high school course.
 Digit 6: Course Level (B for basic or remedial; G for general or regular; E for enriched or advanced, and H for honors).
 Digits 7-10: Available Credit. For example, a course offered as a 1 Carnegie Unit course would indicate 1.00
 Digits 11-12: Sequence of Courses. For example, 34 would be used to indicate this is the third course in a 4 course sequence.

CourseSubjectAreaCode	Optional Choice	This set of code values is derived from the first two digits of the CourseSCEDCode above.	Optional (use one)	minOcc 0 maxOcc 1 Enumerations: EnglishLanguageLiterature Mathematics LifePhysicalSciences SocialSciencesHistory FinePerformingArts ForeignLanguageLiterature ReligiousEducationTheology PhysicalHealthSafetyEducation MilitaryScience ComputerInformationSciences CommunicationsAudioVisualTechnology BusinessMarketing Manufacturing HealthCareSciences PublicProtectiveGovernmentService HospitalityTourism ArchitectureConstruction AgriculturefoodNaturalResources HumanServices TransportationDistributionLogistics EngineeringTechnology Miscellaneous
-----------------------	-----------------	---	--------------------	--

Comment: This is a code set that is based on the first two digits of the Course SCED Code above. The SCED Code is maintained by the US Department of Education's National Center for Education Statistics (NCES). If it is updated in the future, then PESC will keep this code set in synch with the first two digits of the SCED Code.

Tag Name	Schema Use	Description	Recommended Use	Format
CourseQualityPointsEarned	Optional	The numerical value assigned to a letter grade to provide a basis of quantitative determination of an average.	Recommended	minOcc 0 maxOcc 1 xs:decimal
<p>Comment: For example, if the student earned a grade of B in the course, and if the grade of B is worth 3 grade points, and if this course was worth 1 Carnegie Unit, then the value of this data element is "3". Likewise, for a course that is worth 0.5 Carnegie Units, a grade of B would be worth "1.5" CourseQualityPointsEarned.</p>				
CourseLevel	Optional	The level of work demonstrated by successful completion of the academic course being described	Recommended	minOcc 0 maxOcc 1 Enumerations: Accelerated AdultBasic AdvancedPlacement Basic InternationalBaccalaureate CollegeLevel CollegePreparatory GiftedTalented Honors NonAcademic Remedial SpecialEducation TechnicalPreparatory Vocational
CourseGPAApplicabilityCode	Optional	An indicator of whether or not this course being described is included in the computation of the student's Grade Point Average, and if so, if it weighted differently from regular courses.	Recommended	minOcc 0 maxOcc 1 Enumerations: Applicable NotApplicable Weighted
CourseSubjectAbbreviation	Optional	The alphabetic abbreviation of the academic department or discipline offering the course. It is one part of the total course identifier number.	Recommended	minOcc 0 maxOcc 1 minLength 1 maxLength 10
<p>Comment: As with all recommended data elements, if the sending school does not use alphabetic abbreviations as part of the course numbering system, then this data element would not exist and would not be included.</p>				
CourseNumber	Optional	The official reference number portion of a course identifier. This number frequently designates the level of the course as well as the level of the student expected to enroll in the course	Recommended	minOcc 0 maxOcc 1 minLength 1 maxLength 15
CourseSectionNumber	Optional	The number assigned to differentiate among distinct occurrences of courses that have the same course abbreviation and number but are considered to be different courses.	Optional	minOcc 0 maxOcc 1 minLength 1 maxLength 10
<p>Comment: If course section number is used, it should probably be further explained in a note. If it only means, for example, that the course was taught at 9 am instead of 8 am, then it should probably not be included.</p>				
OriginalCourseID	Optional	The course ID as it was listed when the credit was earned (e.g. before a system conversion) to show consistency between present transcripts and older ones.	Recommended	minOcc 0 maxOcc 1 minLength 1 maxLength 30
AgencyCourseID	Optional	The course ID that might have been assigned to this course by the state or other agency	Optional	minOcc 0 maxOcc 1 minLength 1 maxLength 30

Tag Name	Schema Use	Description	Recommended Use	Format
CourseTitle	Optional	The name or title of the course taken by a student at an academic institution.	Recommended	minOcc 0 maxOcc 1 minLength 1 maxLength 60
CourseAddDate	Optional	The date a student was added to an academic course at a school.	Optional	minOcc 0 maxOcc 1 xs:date
Comment: Most high schools would not have this date readily available in the school's database. It would be of questionable value to the receiving postsecondary institution. The format of date is ccy-mm-dd.				
CourseDropDate	Optional	The date on which the student drops or withdraws from the course.	Optional	minOcc 0 maxOcc 1 xs:date
Comment: If this date is readily available, it might be of some value to the receiving postsecondary institution. However, most postsecondary institutions would probably ignore this field				
CourseOverrideSchool	Optional	The school where the credit was earned if different from the Academic Session School	Conditional	minOcc 0 maxOcc 1
Comment: This might be used when a full time student at one school is also taking one course at another high school, community college or university during the session by some sort of prior institutional agreement.				
OverrideSchoolCourseNumber	Optional	The course ID as it was listed at the school where the credit was earned	Conditional	minOcc 0 maxOcc 1 minLength 1 maxLength 35
Comment: CourseOverrideSchool and OverrideSchoolCourseNumber are normally used for situations like consortiums, concurrent enrollment or transfer courses, although transfer work is recommended to be reported in a separate session with an override school.				
CourseApplicability	Optional	The academic program to which this academic course applies toward graduation.	Not Recommended	minOcc 0 maxOcc 1 Enumerations: NotApplicable FirstProgram SecondProgram BothPrograms
CourseBeginDate	Optional	The official begin date for this course	Optional	minOcc 0 maxOcc 1 xs:date
Comment: The format of date is ccy-mm-dd.				
CourseEndDate	Optional	The official end date for this course	Optional	minOcc 0 maxOcc 1 xs:date
Comment: CourseBeginDate and CourseEndDate are recommended when the dates differ from the session begin and end dates. The format for date is ccy-mm-dd.				
CourseInstructionSite	Optional	An indication of the type of location at which the course is taught.	Optional	minOcc 0 maxOcc 1 Enumerations: OnCampus OffCampus Extension StudyAbroad Correctional Military Telecommunication Auxiliary ClinicHospital

Tag Name	Schema Use	Description	Recommended Use	Format
CourseInstructionSiteName	Optional	The name of the location at which the course is taught.	Optional	minOcc 0 maxOcc 1 minLength 1 maxLength 30
Requirement	Optional Repeatable	Curriculum requirements satisfied by successful completion of this course	Optional	minOcc 0 maxOcc ∞
Attribute	Optional Repeatable	Attributes of this course which may require special handling by the receiving institution	Optional	minOcc 0 maxOcc ∞
Proficiency	Optional Repeatable	Proficiency level signified by successful completion of this course	Optional	minOcc 0 maxOcc ∞
Licensure	Optional Repeatable	Licensure requirements satisfied by successful completion of this course	Optional	minOcc 0 maxOcc ∞
LanguageOfInstruction	Optional Repeatable	Language associated with one or more aspects of the course	Optional	minOcc 0 maxOcc ∞
Comment: This optional data element would not be sent if the language is English and the sending school is in the United States.				
NoteMessage	Optional Repeatable	Additional information about the course	Not Recommended	minOcc 0 maxOcc ∞ minLength 1 maxLength 80
UserDefinedExtensions	Optional	Additional structured information. Requires mutually defined XML schema.	Optional	minOcc 0 maxOcc 1

Comment: This is not the appropriate place in the instance document to include courses taken at the sending school. Neither is it the recommended place to include courses transferred in from another school, if enough information is available to include them as a separate session either with an override school indicated, or as another iteration of the academic record for the other school. If possible, always include courses under a session. If this is not possible, for example, if the courses were transferred in from an international school, or not enough information was included about the session at the other school to make the session meaningful, then those transfer courses may be included here.

Student.AcademicRecord.Course (Continued)

Code illustration:

```

<Course>
  <CourseCreditBasis>Regular</CourseCreditBasis>
  <CourseCreditUnits>CarnegieUnits</CourseCreditUnits>
  <CourseCreditLevel />
  <CourseCreditValue>1</CourseCreditValue>
  <CourseCreditEarned>1</CourseCreditEarned>
  <CourseAcademicGradeScaleCode>25</CourseAcademicGradeScaleCode>
  <CourseAcademicGrade>A</CourseAcademicGrade>
  <CourseNarrativeExplanationGrade/>
  <CourseRepeatCode>RepeatCounted</CourseRepeatCode>
  <CourseSCEDCode>04151H1.0011</CourseSCEDCode>
  <CourseQualityPointsEarned>4</CourseQualityPointsEarned>
  <CourseLevel>CollegePreparatory</CourseLevel>
  <CourseSubjectAbbreviation>HIS</CourseSubjectAbbreviation>
  <CourseNumber>201</CourseNumber>
  <CourseSectionNumber />
  <OriginalCourseID>HIST201</OriginalCourseID>
  <AgencyCourseID>HIS020201</AgencyCourseID>
  <CourseTitle>United States History 1</CourseTitle>
  <CourseAddDate>2005-09-01</CourseAddDate>
  <CourseDropDate />
  <CourseOverrideSchool>

  </CourseOverrideSchool>
  <OverrideSchoolCourseNumber/>
  <CourseApplicability/>
  <CourseBeginDate>2005-09-01</CourseBeginDate>
  <CourseEndDate>2005-12-07</CourseEndDate>
  <CourseInstructionSite>OnCampus</CourseInstructionSite>
  <CourseInstructionSiteName/>
  <Requirement>

  </Requirement>
  <Attribute>

  </Attribute>
  <Proficiency>

  </Proficiency>
  <Licensure>

  </Licensure>
  <LanguageOfInstruction>

  </LanguageOfInstruction>
  <NoteMessage />
  <UserDefinedExtensions />
</Course>

```

Student.AcademicRecord.Course.CourseOverrideSchool

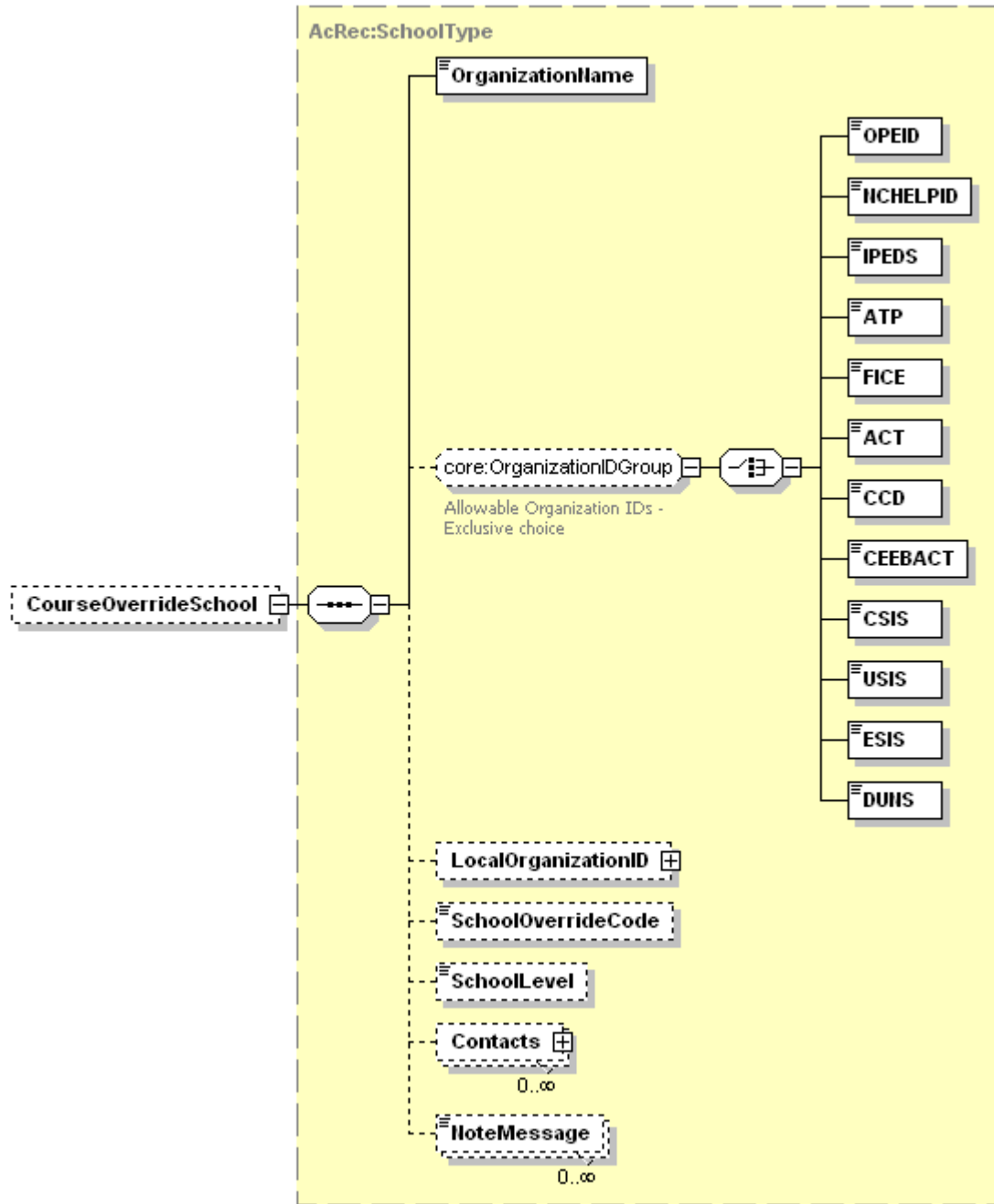

Tag Name	Schema Use	Description	Recommended Use	Format
OrganizationName	Required	Name of override school	Required	minOcc 1 maxOcc 1 minLength 1 maxLength 60
OPEID	Optional choice	The unique identifier assigned by the Office of Postsecondary Education for each data exchange partner.	Recommended (use one)	minOcc 0 maxOcc 1 minLength 3 maxLength 8

Comment: The OPEID would only be appropriate if the course were taken at a postsecondary institution.

Tag Name	Schema Use	Description	Recommended Use	Format
NCHELPID	Optional choice	The unique identifier assigned by National Council on Higher Education Loan Programs for each data exchange partner.	Not Recommended	minOcc 0 maxOcc 1 minLength 3 maxLength 8
Comment: The NCHELPID is not an appropriate choice to describe a school that offers academic courses.				
IPEDS	Optional choice	The unique identifier assigned by the National Center for Education Statistics for the Integrated Postsecondary Education Data System for each postsecondary data exchange partner.	Recommended (use one)	minOcc 0 maxOcc 1 minLength 6 maxLength 6
Comment: The IPEDS code set is not appropriate for indicating a high school that offers an academic course. However, if this override school is a postsecondary institution, then this is an appropriate choice..				
ATP	Optional choice	The unique identifier assigned for the Admissions Testing Program by the College Board for each postsecondary data exchange partner.	Recommended (use one)	minOcc 0 maxOcc 1 minLength 6 maxLength 6
Comment: The ATP code set is not appropriate for indicating a high school that offers an academic course, but if this override school is a postsecondary institution, then this is an appropriate choice.				
FICE	Optional choice	The unique identifier assigned for the Federal Interagency Committee on Education by the US Department of Education's National Center for Education Statistics for each postsecondary data exchange partner	Recommended (use one)	minOcc 0 maxOcc 1 minLength 6 maxLength 6
Comment: The FICE code set is not appropriate for indicating a high school that offers an academic course, but if this override school is a postsecondary institution, then this is an appropriate choice.				
ACT	Optional choice	The unique identifier assigned by the American College Testing or ACT for each postsecondary data exchange partner. See www.act.org.	Recommended (use one)	minOcc 0 maxOcc 1 minLength 4 maxLength 4
Comment: The ACT code set is not appropriate for indicating a high school that offers an academic course, but if this override school is a postsecondary institution, then this is an appropriate choice.				
CCD	Optional choice	The unique identifier assigned by the US Department of Education's National Center for Education Statistics as the Common Core of Data for each K12 data exchange partner.	Recommended (use one)	minOcc 0 maxOcc 1 minLength 12 maxLength 12
CEEBACT	Optional choice	The unique identifier assigned by the College Entrance Examining Board and ACT for each data exchange partner.	Recommended (use one)	minOcc 0 maxOcc 1 minLength 6 maxLength 6
Comment: The CEEBACT code set is arguably the most common code for indicating a high school that offers academic courses.				
CSIS	Optional choice	The unique identifier assigned by the Statistics Canada Canadian College Student Information System for each data exchange partner	Recommended (use one)	minOcc 0 maxOcc 1 minLength 6 maxLength 6
USIS	Optional choice	The unique identifier assigned by the Statistics Canada University Student Information System for each data exchange partner	Recommended (use one)	minOcc 0 maxOcc 1 minLength 6 maxLength 6

Tag Name	Schema Use	Description	Recommended Use	Format
ESIS	Optional choice	The unique identifier assigned by the Statistics Canada Enhanced Student Information System for each data exchange partner.	Recommended (use one)	minOcc 0 maxOcc 1 minLength 8 maxLength 8
DUNS	Optional choice	Data Universal Numbering System (DUNS), unique nine character company identification number issued by Dun and Bradstreet Corporation.	Recommended (use one)	minOcc 0 maxOcc 1 minLength 9 maxLength 9
Comment: The DUNS code would not normally be an appropriate code set to use to indicate an academic institution that offered an academic course.				
Comment: Although it is not necessary to send one of the above 12 codes, if you choose to do so, then choose one of the noted appropriate codes.				
LocalOrganizationID	Optional	A code set typically used by a state, province or region to further identify the school whose record is beng sent	Optional	minOcc 0 maxOcc 1
Comment: This complex data element will be expanded on page XXX which follows.				
SchoolOverrideCode	Optional	The source of the academic credit if not awarded by the home or parent institution. <i>Institutional</i> - Institutional Agreement <i>Multicampus</i> - Multiple Campus Course Offering <i>Transfer</i> - Transfer Credit <i>StudyAbroad</i> - Study Abroad <i>Coop</i> - Cooperative Program <i>Reciprocal</i> - Reciprocal Exchange <i>Internship</i> - Internship	Recommended	minOcc 0 maxOcc 1 Enumerations: Institutional Multicampus Transfer StudyAbroad Coop Reciprocal Internship
SchoolLevel	Optional	Indicates level of Override School	Recommended	minOcc 0 maxOcc 1 Enumerations: Elementary Secondary Postsecondary
Contacts	Optional Repeatable	Contact info at Override School	Optional	minOcc 0 maxOcc 1
Comment: This complex data element will be expanded on page XXX which follows.				
NoteMessage	Optional Repeatable	Additional information about the Override School	Not Recommended	minOcc 0 maxOcc ∞ minLength 1 maxLength 80

Code illustration:

```

<School>
  <OrganizationName>Miami Dade School District; Miami Senior High School</OrganizationName>
  <CEEBACT>101075</CEEBACT>
  <LocalOrganizationID>

  </LocalOrganizationID>
  <SchoolOverrideCode>Reciprocal</SchoolOverrideCode>
  <SchoolLevel>Secondary</SchoolLevel>
  <Contacts>

  </Contacts>
  <Note/Message />
</School>
    
```

Student.AcademicRecord.Course.CourseOverrideSchool.LocalOrganizationID

Note: Although the complex data element LocalOrganizationID is an optional data element, if you choose to send LocalOrganizationID, then you must also send both LocalOrganizationIDCode and also LocalOrganizationIDQualifier

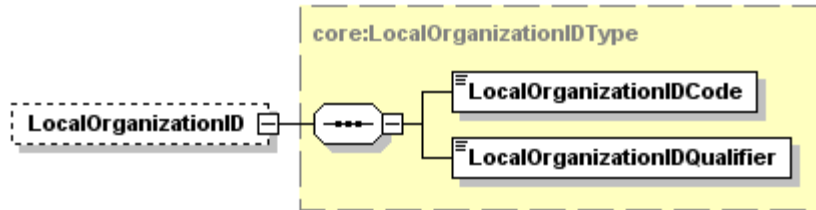

Tag Name	Schema Use	Description	Recommended Use	Format
LocalOrganizationIDCode	Required	The code assigned for the receiving school by the state, province or other mutually defined agency specified in the LocalIDQualifier that follows.	Required	minOcc 1 maxOcc 1 minLength 1 maxLength 35
Comment: This is a required data element only if the LocalOrganizationID data element is sent. This is typically the administrative school code assigned by a state or province to specifically identify the receiving school in that state. If it is not assigned by a state or province, then code ZZ should be used in the LocalOrganizationID Qualifier that follows.				
LocalOrganizationIDQualifier	Required	This is the state, province or other mutually defined agency that assigned the Local ID Code above.	Required	minOcc 1 maxOcc 1 See Appendix A.
Comment: This is a required data element only if the Local ID data element is sent. This is typically the state or province that assigned the code to specifically identify the receiving school in that state. If it is not assigned by a state or province, then code ZZ should be used in this data element				

Code illustration:

```
<LocalOrganizationID>
  <LocalOrganizationIDCode>340005501</LocalOrganizationIDCode>
  <LocalOrganizationIDQualifier>FL</LocalOrganizationIDQualifier>
</LocalOrganizationID>
```

Student.AcademicRecord.Course.CourseOverrideSchool.Contacts

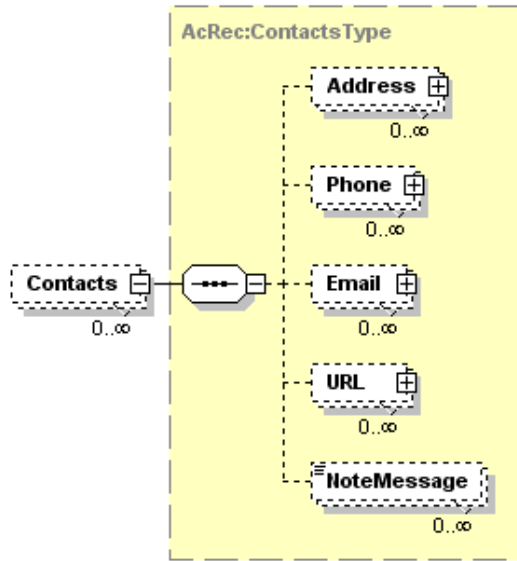

Tag Name	Schema Use	Description	Recommended Use	Format
Address	Optional Repeatable	Address of the Override School	Recommended	minOcc 0 maxOcc ∞
<i>Comment: This complex data element will be expanded on page XXX which follows.</i>				
Phone	Optional Repeatable	Phone Number of the Override School	Optional	minOcc 0 maxOcc ∞
<i>Comment: This complex data element will be expanded on page XXX which follows.</i>				
Email	Optional Repeatable	Email Address of the Override School	Optional	minOcc 0 maxOcc ∞
<i>Comment: This complex data element will be expanded on page XXX which follows.</i>				
URL	Optional Repeatable	Universal Resouce Locator of the Override School	Optional	minOcc 0 maxOcc ∞
<i>Comment: This complex data element will be expanded on page XXX which follows.</i>				
NoteMessage	Optional Repeatable	Additional information about the contacts at the Override School	Not Recommended	minOcc 0 maxOcc ∞ minLength 1 maxLength 80

Code illustration:

```

<Contacts>
  <Address>

  </Address>
  <Phone>

  </Phone>
  <Email>

  </Email>
  <URL>

  </URL>
  <NoteMessage />
</Contacts>
    
```

Student.AcademicRecord.Course.CourseOverrideSchool.Contacts.Address

Note: Although the complex data element Address is an optional data element, if you choose to send the Address of the Course Override School, then you must send AddressLine and City and also StateProvinceCode, and PostalCode OR CountryCode.

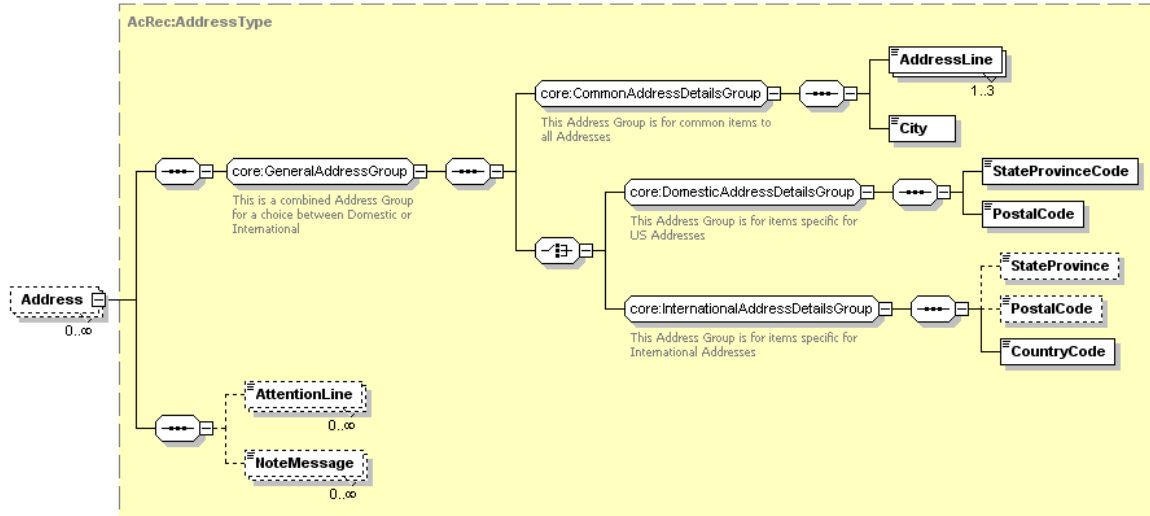

Tag Name	Schema Use	Description	Recommended Use	Format
<i>GeneralAddressGroup</i>	Required	This Address Group is for items common to all Addresses	Required	minOcc 1 maxOcc 1
Comment: [<i>GeneralAddressGroup</i>] does not appear in the instance document. It requires the use of <i>CommonAddressDetailsGroup</i> and the choice of one of either <i>DomesticAddressDetailsGroup</i> or <i>InternationalAddressDetailsGroup</i> . This group is required in the schema only if you choose to send the address of the contact.				
<i>CommonAddressDetailsGroup</i>	Required	This Address Group is for items common to all Addresses	Required	minOcc 1 maxOcc 1
Comment: [<i>CommonAddressDetailsGroup</i>] does not appear in the instance document. If the address of a contact is included in the transcript, then this must be sent. It is required and must be paired with one of either <i>DomesticAddressDetailsGroup</i> or <i>InternationalAddressDetailsGroup</i> .				
<i>AddressLine</i>	Required Repeatable	Local delivery information such as street, building number, PO box, or apartment portion of a postal address of a Contact at the Sending (Source) High School.	Required	minOcc 1 maxOcc 3 minLength 1 maxLength 40
<i>City</i>	Required	The city portion of the Address of a Contact at the Sending (Source) High School.	Required	minOcc 1 maxOcc 1 minLength 2 maxLength 30
<i>DomesticAddressDetailsGroup</i>	Required choice	This Address Group is for items specific for US and Canadian Addresses	Required for domestic addresses	minOcc 1 maxOcc 1
Comment: [<i>DomesticAddressDetailsGroup</i>] does not appear in the instance document. If the complex data element address has a United States or Canadian Postal Code and a US State or Canadian Province Code, then this should be the required choice.				

Tag Name	Schema Use	Description	Recommended Use	Format
StateProvinceCode	Required	Code for US states, etc., and Canadian provinces.	Required	minOcc 1 maxOcc 1 Enumerations: See Appendix A
PostalCode	Required	The postal code portion of the Address.	Required	minOcc 1 maxOcc 1 minLength 1 maxLength 17
<i>InternationalAddressDetailsGroup</i>	Required choice	This Address Group is for items specific for International Addresses	Required for international addresses	minOcc 1 maxOcc 1
Comment: [InternationalAddressDetailsGroup] does not appear in the instance document. This choice is for addresses that do not have a US or Canadian postal code.				
StateProvince	Optional	The literal name of the state, province or territory of a postal address of the source of this document. Use for addresses outside US or Canada.	Recommended Refer to common postal practices of the source country	minOcc 0 maxOcc 1 minLength 2 maxLength 30
Comment: For an internet resource of states or other geographical subdivisions in countries other than the US and Canada, you might choose to refer to the website of the Universal Postal Union at http://www.upu.int				
PostalCode	Optional	The postal code portion of the Address.	Recommended Refer to common postal practices of the source country	minOcc 0 maxOcc 1 minLength 1 maxLength 17
Comment: For an internet resource of states or other geographical subdivisions in countries other than the US and Canada, you might choose to refer to the website of the Universal Postal Union at http://www.upu.int				
CountryCode	Required	Code indicating Country. Use ISO 3166-1 alpha-2 standard.	Required	minOcc 1 maxOcc 1 Enumerations: See Appendix B
AttentionLine	Optional	The individual or office name within the postal address where inquiries should be directed.	Optional	minOcc 1 maxOcc ∞ minLength 1 maxLength 45
Comment: This might be used to indicate where questions about the record should be sent. For example, <i>Principal, Guidance Counselor, Headmaster, etc.</i>				
NoteMessage	Optional Repeatable	Additional information about the addresses of the contacts at the source school	Not recommended	minOcc 0 maxOcc ∞ minLength 1 maxLength 80

**Student.AcademicRecord.Course.CourseOverrideSchool.Contacts.
Address (Continued)**

Code illustration 1 (Domestic Address):

```
<Address>
  <AddressLine>1715 W Cesar Chavez</AddressLine>
  <City>Austin</City>
  <StateProvinceCode>TX</StateProvinceCode>
  <PostalCode>78703</PostalCode>
  <AttentionLine>Jane Doe</AttentionLine>
    <AttentionLine>Guidance Counselor</AttentionLine>
  <NoteMessage />
</Address>
```

Code illustration 2 (International Address):

```
<Address>
  <AddressLine>Altova Corporation</AddressLine>
  <AddressLine>Rudolfsplatz 13a/9</AddressLine>
  <City>Wien</City>
  <StateProvince />
  <PostalCode>A-1010</PostalCode>
  <CountryCode>AT</CountryCode>
</Address>
```

Student.AcademicRecord.Course.CourseOverrideSchool.Contacts.Phone

Note: Although the complex data element Phone is an optional data element, if you choose to send the Phone of the Override School, then you must send the phone number.

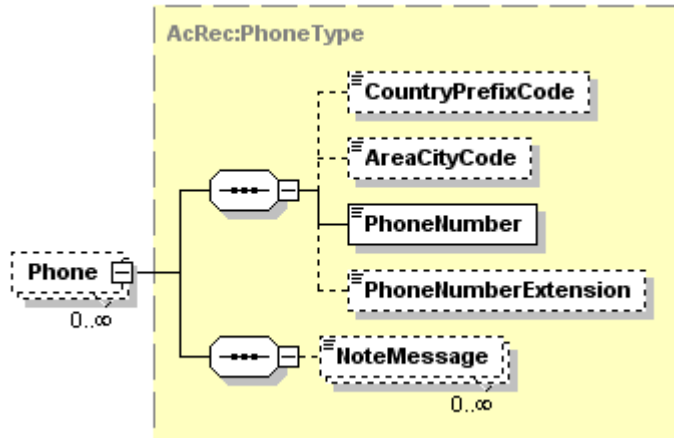

Tag Name	Schema Use	Description	Recommended Use	Format
CountryPrefixCode	Optional	International dialing code.	Optional	minOcc 0 maxOcc 1 minLength 1 maxLength 3
AreaCityCode	Optional	Regional dialing code.	Recommended	minOcc 0 maxOcc 1 minLength 1 maxLength 5
Comment: This is the 3 digit area code in the United States and Canada.				
PhoneNumber	Required	Telephone number.	Required	minOcc 1 maxOcc 1 minLength 1 maxLength 11
Comment: The phone number is normally included as a text string with no dashes.				
PhoneNumberExtension	Optional	The extended telephone addressing information used in addition to phone number such as a PBX extension, a pager PIN, or FAX sub-address.	Optional	minOcc 0 maxOcc 1 minLength 1 maxLength 5
NoteMessage	Optional Repeatable	Additional information about the phone number of the override school	Not recommended	minOcc 0 maxOcc ∞ minLength 1 maxLength 80
Comment: This is the phone of the Override School.				

Code illustration:

```
<Phone>
  <CountryPrefixCode />
  <AreaCityCode>512</AreaCityCode>
  <PhoneNumber>4757638</PhoneNumber>
  <PhoneNumberExtension/>
  <NoteMessage />
</Phone>
```

Student.AcademicRecord.Course.CourseOverrideSchool.Contacts. Email

Note: Although the complex data element Email is an optional data element, if you choose to send the Email of the Override School, then you must send the EmailAddress.

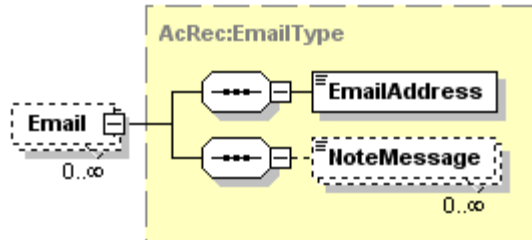

Tag Name	Schema Use	Description	Recommended Use	Format
EmailAddress	Required	The numbers, letters, and symbols used to identify an electronic mail (Email) user within a network.	Required	minOcc 1 maxOcc 1 minLength 1 maxLength 128
NoteMessage	Optional Repeatable	Additional information about the email address	Not recommended	minOcc 0 maxOcc ∞ minLength 1 maxLength 80

Comment: This is the Email of the Course Override School.

Code illustration:

```
<Email>
  <EmailAddress>registrar@newtrier.k12.il.us</EmailAddress>
  <NoteMessage/>
</Email>
```

Student.AcademicRecord.Course.CourseOverrideSchool.Contacts.URL

Note: Although the complex data element URL is an optional data element, if you choose to send the URL of the Override School, then you must send the URLAddress.

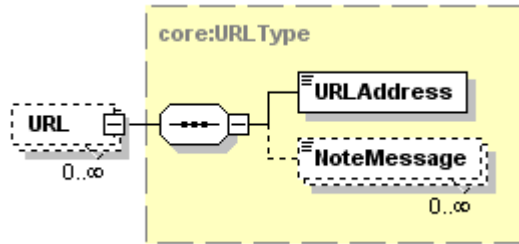

Tag Name	Schema Use	Description	Recommended Use	Format
URLAddress	Required	The Uniform Resource Locator (URL) address associated with a product, deliverable or contact.	Required	minOcc 1 maxOcc 1 minLength 0 maxLength 512
NoteMessage	Optional Repeatable	Additional information about the URL	Not Recommended	minOcc 0 maxOcc ∞ minLength 1 maxLength 80
Comment: This is the URL of the Course Override School.				

Code illustration:

```
<URL>
  <URLAddress>http://nth.s.newtrier.k12.il.us</URLAddress>
  <NoteMessage />
</URL>
```

Student.AcademicRecord.Course.Requirement

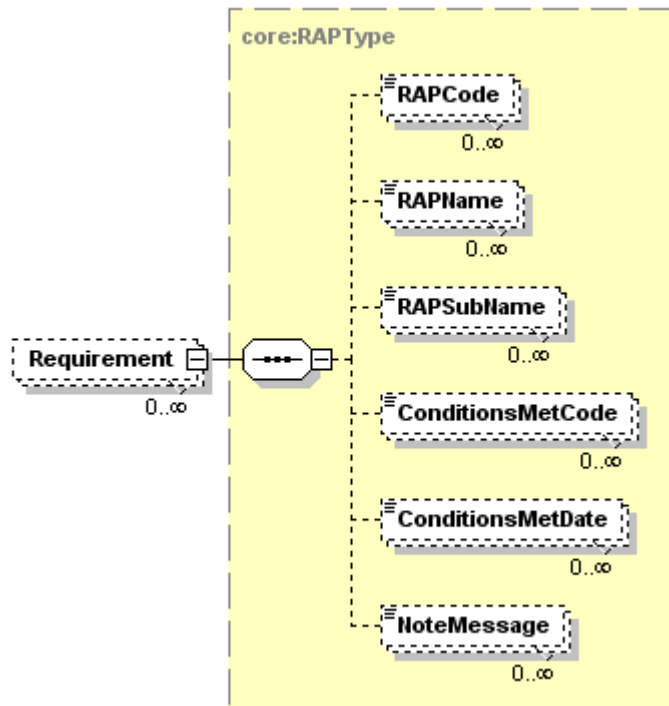

Tag Name	Schema Use	Description	Recommended Use	Format
RAPCode	Optional Repeatable	Requirement demonstrated or earned in addition to or as part of an academic award.	Recommended	minOcc 0 maxOcc ∞ minLength 1 maxLength 3
Comment: If this data element is to be used effectively, a code set should be created by a state or region. An example is given below in the Code Illustration. If not, then User Defined Extensions would be an alternate method of including this information.				
RAPName	Optional Repeatable	Literal name of requirement	Recommended	minOcc 0 maxOcc ∞ minLength 1 maxLength 60
RAPSubName	Optional Repeatable	Literal name of subsection of requirement	Optional	minOcc 0 maxOcc ∞ minLength 1 maxLength 60
ConditionsMetCode	Optional Repeatable	Indicates whether and how conditions for the requirement have been attained.	Recommended	minOcc 0 maxOcc ∞ Enumerations: Yes No Conditional MutuallyDefined
ConditionsMetDate	Optional Repeatable	Date requirement was met.	Optional	minOcc 0 maxOcc ∞ xs:date
Comment: The format of date is cyy-mm-dd.				

Tag Name	Schema Use	Description	Recommended Use	Format
NoteMessage	Optional Repeatable	Additional information about the requirement	Not Recommended	minOcc 0 maxOcc ∞ minLength 1 maxLength 80

Comment: For example, the Requirement part of the course could be used to indicate that completion of this course satisfies a computer literacy requirement for graduation or a Community Service requirement. It could also be use to indicate that this course meets a requirement for admission to the state university system.

Code illustration:

```

<Requirement>
  <RAPCode>9TX</RAPCode>
  <RAPName>TXDegReq</RAPName>
  <RAPSubName>UT Austin Writing Component</RAPSubName>
  <ConditionsMetCode>Yes</ConditionsMetCode>
  <ConditionsMetDate>2002-08-13</ConditionsMetDate>
  <NoteMessage />
</Requirement>
    
```

Student.AcademicRecord.Course.Attribute

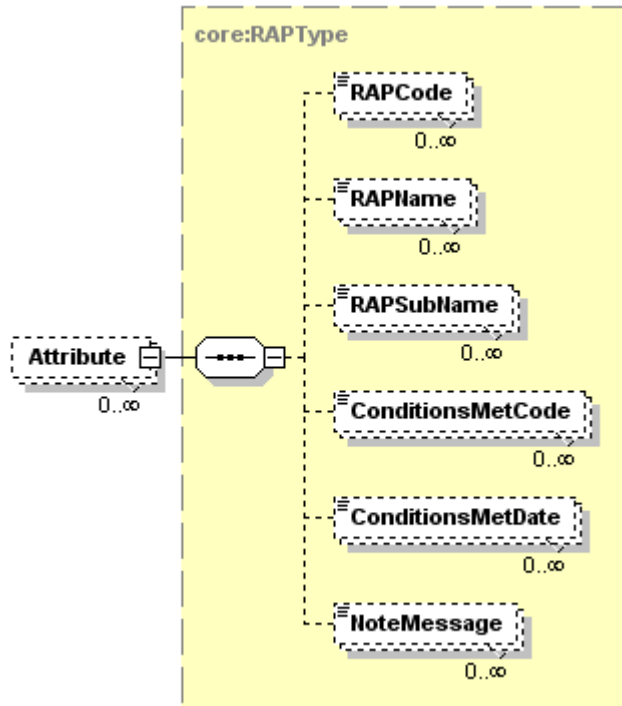

Tag Name	Schema Use	Description	Recommended Use	Format
RAPCode	Optional Repeatable	Attribute demonstrated or earned in addition to academic award.	Recommended	minOcc 0 maxOcc ∞ minLength 1 maxLength 3
Comment: If this data element is to be used effectively, a code set should be created by a state or region. An example is given below in the Code Illustration. If not, then User Defined Extensions would be an alternate method of including this information.				
RAPName	Optional Repeatable	Literal name of attribute	Recommended	minOcc 0 maxOcc ∞ minLength 1 maxLength 60
RAPSubName	Optional Repeatable	Literal name of subsection of attribute	Optional	minOcc 0 maxOcc ∞ minLength 1 maxLength 60
ConditionsMetCode	Optional Repeatable	Indicates whether and how conditions for certification have been attained.	Recommended	minOcc 0 maxOcc ∞ Enumerations: Yes No Conditional MutuallyDefined
ConditionsMetDate	Optional Repeatable	Date of attribute	Optional	minOcc 0 maxOcc ∞
Comment: The format for date is ccyymm-dd.				

Tag Name	Schema Use	Description	Recommended Use	Format
NoteMessage	Optional Repeatable	Additional information about the attribute	Not Recommended	minOcc 0 maxOcc ∞ minLength 1 maxLength 80

Comment: For example, the Attribute part of the course could be used to indicate that the course was taught by a university professor, or it was taught in a hands-on computer lab, etc. It would normally only have significant meaning when used by all participating schools within a state or region.

Code illustration:

```

<Attribute>
  <RAPCode>9TX</RAPCode>
  <RAPName>TXCORECURR</RAPName>
  <RAPSubName>020Mathematics (I)</RAPSubName>
  <ConditionsMetCode>Yes</ConditionsMetCode>
  <ConditionsMetDate>1997-03-01</ConditionsMetDate>
  <NoteMessage />
</Attribute>
    
```

Student.AcademicRecord.Course.Proficiency

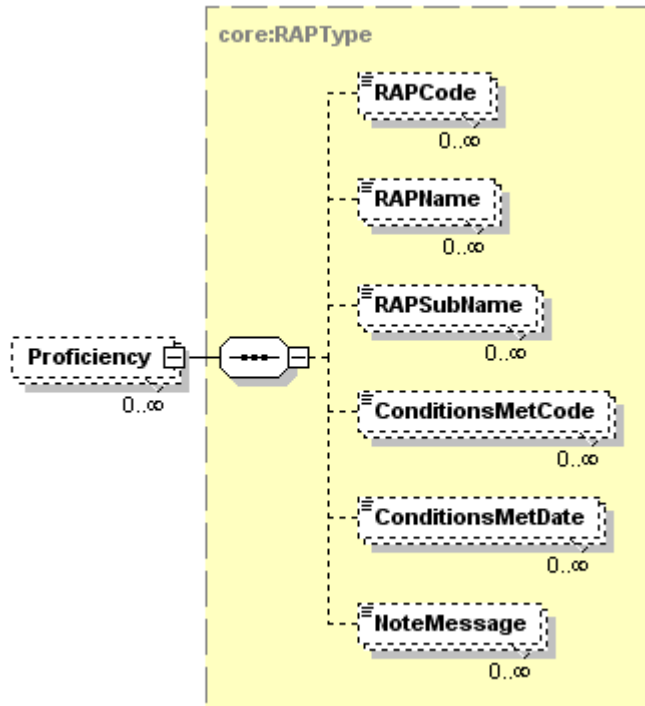

Tag Name	Schema Use	Description	Recommended Use	Format
RAPCode	Optional Repeatable	Proficiency demonstrated or earned in addition to academic award.	Recommended	minOcc 0 maxOcc ∞ minLength 1 maxLength 3
Comment: If this data element is to be used effectively, a code set should be created by a state or region. An example is given below in the Code Illustration. If not, then User Defined Extensions would be an alternate method of including this information.				
RAPName	Optional Repeatable	Literal name of proficiency	Recommended	minOcc 0 maxOcc ∞ minLength 1 maxLength 60
RAPSubName	Optional Repeatable	Literal name of subsection of proficiency	Optional	minOcc 0 maxOcc ∞ minLength 1 maxLength 60
ConditionsMetCode	Optional Repeatable	Indicates whether and how conditions for certification have been attained.	Recommended	minOcc 0 maxOcc ∞ Enumerations: Yes No Conditional MutuallyDefined
ConditionsMetDate	Optional Repeatable	Date of proficiency	Optional	minOcc 0 maxOcc ∞ xs:date
Comment: The format for date is ccy-mm-dd.				

Tag Name	Schema Use	Description	Recommended Use	Format
NoteMessage	Optional Repeatable	Additional information about the proficiency	Not Recommended	minOcc 0 maxOcc ∞ minLength 1 maxLength 80

Comment: For example, the Proficiency part of the course could be used to indicate successful completion of this course demonstrates a school graduation requirement for computer competency or English proficiency.

Code illustration:

```

<Proficiency>
  <RAPCode>9TX</RAPCode>
  <RAPName>Computer Literacy Proficiency</RAPName>
  <RAPSubName>CSPROF - ComputerSkillsProficiency</RAPSubName>
  <ConditionsMetCode>Yes</ConditionsMetCode>
  <ConditionsMetDate>2004-10-23</ConditionsMetDate>
  <NoteMessage>Students learn MS Word, PPT and Web Search in this course.</NoteMessage>
</Proficiency>
    
```

Student.AcademicRecord.Course.Licensure

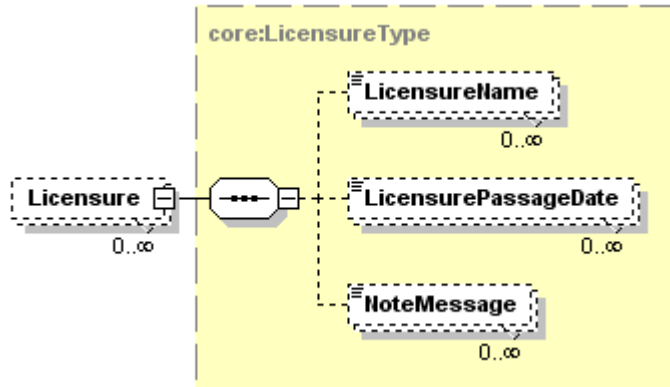

Tag Name	Schema Use	Description	Recommended Use	Format
LicensureName	Optional Repeatable	Free-form name of license or certification.	Recommended	minOcc 0 maxOcc ∞ minLength 1 maxLength 60
LicensurePassageDate	Optional Repeatable	Date of licensure passage	Optional	minOcc 0 maxOcc ∞ xs:date
Comment: The format for date is ccyy-mm-dd.				
NoteMessage	Optional Repeatable	Additional information about the licensure	Not Recommended	minOcc 0 maxOcc ∞ minLength 1 maxLength 80

Code illustration:

```

<Licensure>
  <LicensureName>Occupational Therapy Assistant</LicensureName>
  <LicensurePassageDate>2004-05-20</LicensurePassageDate>
  <NoteMessage />
</Licensure>
    
```

Student.AcademicRecord.Course.LanguageOfInstruction

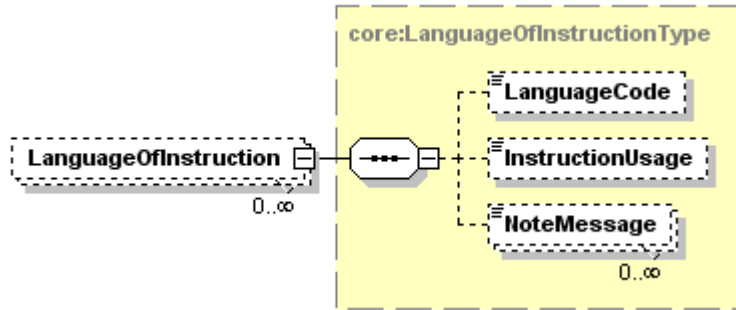

Tag Name	Schema Use	Description	Recommended Use	Format
LanguageCode	Optional	Code indicating the language being used, using ISO 639-2 code (Alpha-3) set. These codes are available at http://www.loc.gov/standards/iso639-2/	Recommended	minOcc 0 maxOcc 1 minLength 3 maxLength 3
InstructionUsage	Optional	The use of the language in the context of instruction. <i>Instruction</i> - Language of Instruction <i>Examination</i> - Language of Examination <i>WrittenExam</i> - Language in which Examination is written	Recommended	minOcc 0 maxOcc 1 Enumerations: Instruction Examination WrittenExam
NoteMessage	Optional Repeatable	Additional information about the language of instruction	Not Recommended	minOcc 0 maxOcc ∞ minLength 1 maxLength 80

Comment: This is an optional data element. If it is not included, it is assumed the language of instruction was English if the high school sending the record is in the United States.

Code illustration:

```
<LanguageOfInstruction>
  <LanguageCode>fre</LanguageCode>
  <InstructionUsage>Instruction</InstructionUsage>
  <NoteMessage />
</LanguageOfInstruction>
```

Student.AcademicRecord.AdditionalStudentAchievements

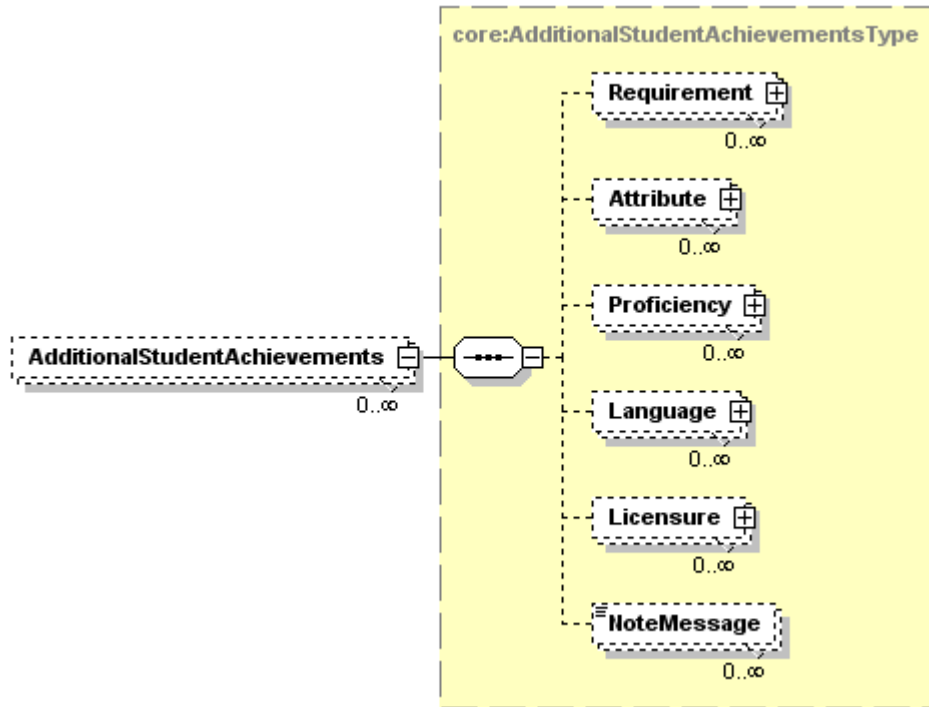

Tag Name	Schema Use	Description	Recommended Use	Format
Requirement	Optional Repeatable	Curriculum requirements satisfied by successful completion of the Additional Student Achievement	Optional	minOcc 0 maxOcc ∞
Attribute	Optional Repeatable	Attributes of the Additional Student Achievement which may require special handling by the receiving institution	Optional	minOcc 0 maxOcc ∞
Proficiency	Optional Repeatable	Proficiency level signified by successful completion of the Additional Student Achievement	Optional	minOcc 0 maxOcc ∞
Language	Optional Repeatable	Language associated with one or more aspects of the Additional Student Achievement	Optional	minOcc 0 maxOcc ∞
Licensure	Optional Repeatable	Licensure requirements satisfied by successful completion of the Additional Student Achievement	Optional	minOcc 0 maxOcc ∞
NoteMessage	Optional Repeatable	Additional information about the Additional Student Achievement	Not Recommended	minOcc 0 maxOcc ∞ minLength 1 maxLength 80

Comment: The use of the Requirement, Attribute and Proficiency fields is normally based on previously made agreements between or among selected trading partners (usually within a state or region). For example, a specific state might have a requirement for computer competency. That state might use a requirement code of TXA, where TX is the state code and A designates the computer competency requirement. Another state might wish to identify an attribute of the student that indicates the student is the first in his or her family to attend or graduate from a high school. This attribute might be identified with a state code of IA and the attribute code of B. This attribute would be based on prior agreements among states, and it provides a great deal of flexibility to exchange previously specified data within a state or region.

Student.AcademicRecord.AdditionalStudentAchievements (Continued)

Code illustration:

```
<AdditionalStudentAchievements>  
  <Requirement>  
  
    </Requirement>  
    <Attribute>  
  
      </Attribute>  
      <Proficiency>  
  
        </Proficiency>  
        <Language>  
  
          </Language>  
          <Licensure>  
  
            </Licensure>  
            <NoteMessage />  
</AdditionalStudentAchievements>
```

Student.AcademicRecord.AdditionalStudentAchievements.Requirement

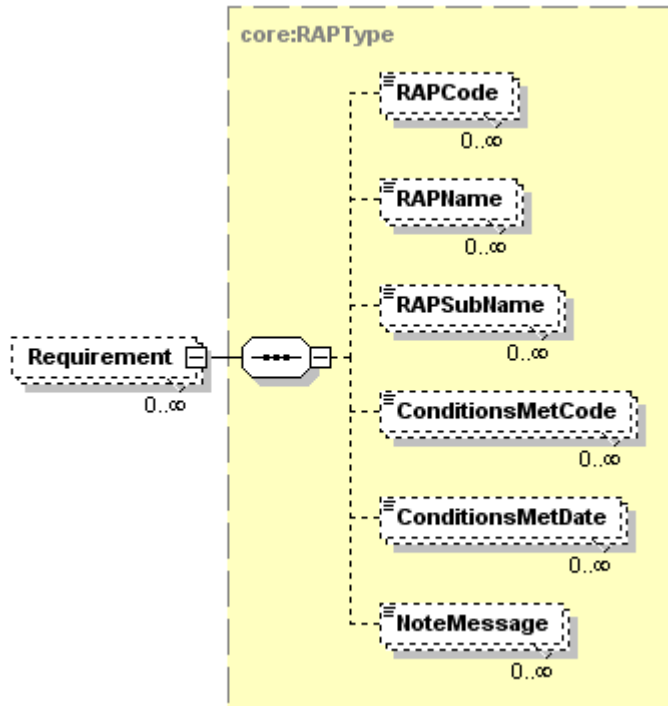

Tag Name	Schema Use	Description	Recommended Use	Format
RAPCode	Optional Repeatable	Requirement demonstrated or earned in addition to or as part of an academic award.	Recommended	minOcc 0 maxOcc ∞ minLength 1 maxLength 3
Comment: If this data element is to be used effectively, a code set should be created by a state or region. An example is given below in the Code Illustration. If not, then User Defined Extensions would be an alternate method of including this information.				
RAPName	Optional Repeatable	Literal name of requirement	Recommended	minOcc 0 maxOcc ∞ minLength 1 maxLength 60
RAPSubName	Optional Repeatable	Literal name of subsection of requirement	Optional	minOcc 0 maxOcc ∞ minLength 1 maxLength 60
ConditionsMetCode	Optional Repeatable	Indicates whether and how conditions for the requirement have been attained.	Recommended	minOcc 0 maxOcc ∞ Enumerations: Yes No Conditional MutuallyDefined
ConditionsMetDate	Optional Repeatable	Date requirement was met.	Optional	minOcc 0 maxOcc ∞ xs:date
Comment: The format of date is cyy-mm-dd.				

Tag Name	Schema Use	Description	Recommended Use	Format
NoteMessage	Optional Repeatable	Additional information about the requirement	Not Recommended	minOcc 0 maxOcc ∞ minLength 1 maxLength 80

Comment: For example, the Requirement part of Additional Student Achievements could be used to indicate that the student has met all the requirements for admission to a specific limited access program in the state university system.

Code illustration:

```

<Requirement>
  <RAPCode>9FL</RAPCode>
  <RAPName>FL-BS-Nursing-Admission-Rqmt</RAPName>
  <RAPSubName />
  <ConditionsMetCode>Yes</ConditionsMetCode>
  <ConditionsMetDate>2002-08-13</ConditionsMetDate>
  <NoteMessage />
</Requirement>
    
```

Student.AcademicRecord. AdditionalStudentAchievements.Attribute

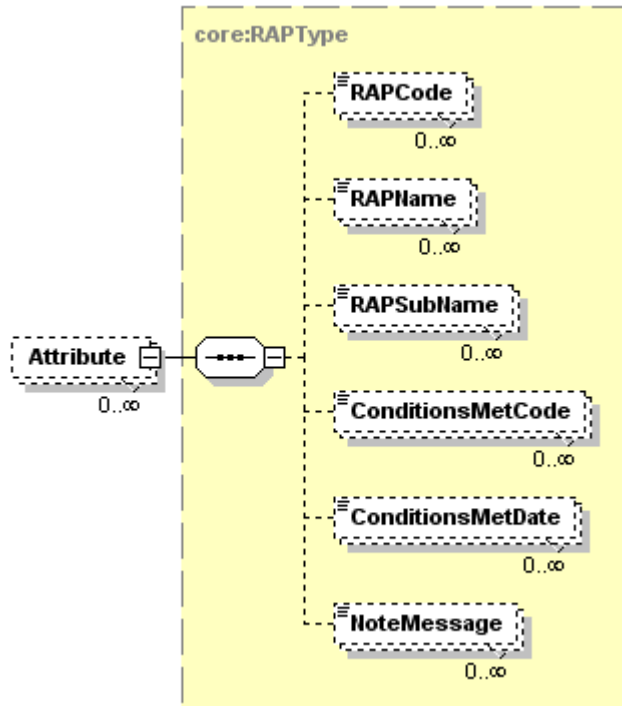

Tag Name	Schema Use	Description	Recommended Use	Format
RAPCode	Optional Repeatable	Attribute demonstrated or earned in addition to academic award.	Recommended	minOcc 0 maxOcc ∞ minLength 1 maxLength 3
Comment: If this data element is to be used effectively, a code set should be created by a state or region. An example is given below in the Code Illustration. If not, then User Defined Extensions would be an alternate method of including this information.				
RAPName	Optional Repeatable	Literal name of attribute	Recommended	minOcc 0 maxOcc ∞ minLength 1 maxLength 60
RAPSubName	Optional Repeatable	Literal name of subsection of attribute	Optional	minOcc 0 maxOcc ∞ minLength 1 maxLength 60
ConditionsMetCode	Optional Repeatable	Indicates whether and how conditions for certification have been attained.	Recommended	minOcc 0 maxOcc ∞ Enumerations: Yes No Conditional MutuallyDefined
ConditionsMetDate	Optional Repeatable	Date of attribute	Optional	minOcc 0 maxOcc ∞
Comment: The format for date is ccyymm-dd.				

Tag Name	Schema Use	Description	Recommended Use	Format
NoteMessage	Optional Repeatable	Additional information about the attribute	Not Recommended	minOcc 0 maxOcc ∞ minLength 1 maxLength 80

Comment: For example, the Attribute part of the Additional Student Achievements could be used to indicate that the student was the first member of his or her family to complete a high school education.

Code illustration:

```

<Attribute>
  <RAPCode>9FL</RAPCode>
  <RAPName>FirstHSGraduateInFamily</RAPName>
  <RAPSubName />
  <ConditionsMetCode>Yes</ConditionsMetCode>
  <ConditionsMetDate>1997-03-01</ConditionsMetDate>
  <NoteMessage />
</Attribute>
    
```

Student.AcademicRecord. AdditionalStudentAchievements.Proficiency

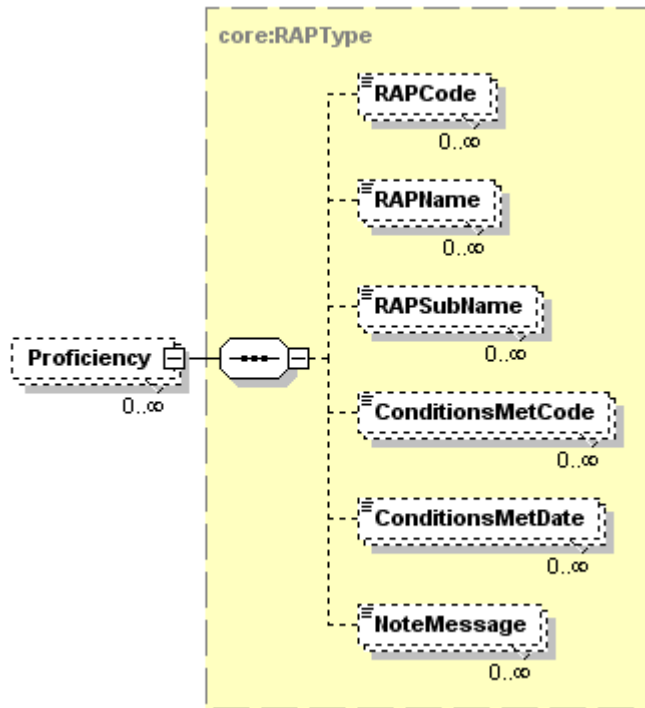

Tag Name	Schema Use	Description	Recommended Use	Format
RAPCode	Optional Repeatable	Proficiency demonstrated or earned in addition to academic award.	Recommended	minOcc 0 maxOcc ∞ minLength 1 maxLength 3
Comment: If this data element is to be used effectively, a code set should be created by a state or region. An example is given below in the Code Illustration. If not, then User Defined Extensions would be an alternate method of including this information.				
RAPName	Optional Repeatable	Literal name of proficiency	Recommended	minOcc 0 maxOcc ∞ minLength 1 maxLength 60
RAPSubName	Optional Repeatable	Literal name of subsection of proficiency	Optional	minOcc 0 maxOcc ∞ minLength 1 maxLength 60
ConditionsMetCode	Optional Repeatable	Indicates whether and how conditions for certification have been attained.	Recommended	minOcc 0 maxOcc ∞ Enumerations: Yes No Conditional MutuallyDefined
ConditionsMetDate	Optional Repeatable	Date of proficiency	Optional	minOcc 0 maxOcc ∞ xs:date

Comment: The format for date is ccyy-mm-dd.

Tag Name	Schema Use	Description	Recommended Use	Format
NoteMessage	Optional Repeatable	Additional information about the proficiency	Not Recommended	minOcc 0 maxOcc ∞ minLength 1 maxLength 80

Comment: For example, the Proficiency part of the Additional Student Achievements could be used to indicate the student is proficient in a musical instrument and demonstrated this by participating in the marching band.

Code illustration:

```

<Proficiency>
  <RAPCode>9FL</RAPCode>
  <RAPName>Music Proficiency</RAPName>
  <RAPSubName>Trombone</RAPSubName>
  <ConditionsMetCode>Yes</ConditionsMetCode>
  <ConditionsMetDate>2004-10-23</ConditionsMetDate>
  <NoteMessage >Student played in the school marching band.</NoteMessage>
</Proficiency>
    
```

Student.AcademicRecord.AdditionalStudentAchievements.Language

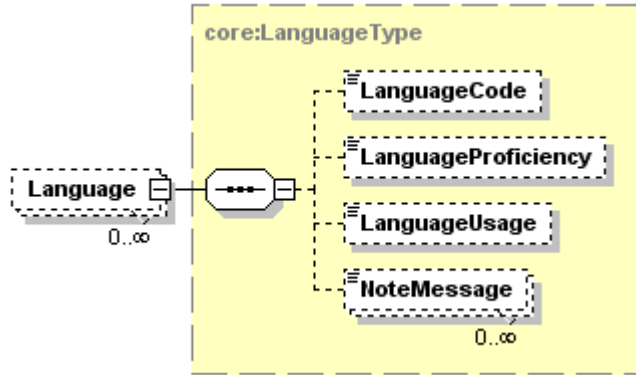

Tag Name	Schema Use	Description	Recommended Use	Format
LanguageCode	Optional	Code indicating the language being used, using ISO 639-2 code (Alpha-3) set. These codes are available at http://www.loc.gov/standards/iso639-2/	Recommended	minOcc 0 maxOcc 1 See codes in Appendix G
LanguageProficiency	Optional	Adeptness in comprehending and using the language	Recommended	minOcc 0 maxOcc 1 Enumerations: Excellent Good Fair Poor Unacceptable Unknown
LanguageUsage	Optional	Indication of person's use of the language	Recommended	minOcc 0 maxOcc 1 Enumerations: SpokenAtHome Reading Writing Speaking Native
NoteMessage	Optional Repeatable	Additional information about the language proficiency	Not Recommended	minOcc 0 maxOcc ∞ minLength 1 maxLength 80

Comment: This is the appropriate place in the Schema to indicate that a student is proficient in a language other than English.

Code illustration:

```
<Language>
  <LanguageCode>rus</LanguageCode>
  <LanguageProficiency>Excellent</LanguageProficiency>
  <LanguageUsage>Speaking</LanguageUsage>
  <NoteMessage />
</Language>
```

Student.AcademicRecord. AdditionalStudentAchievements.Licensure

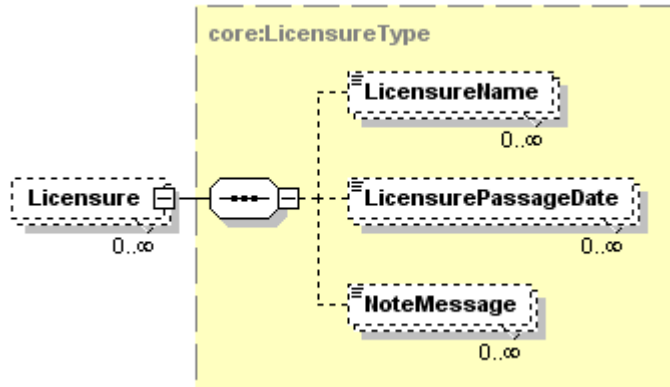

Tag Name	Schema Use	Description	Recommended Use	Format
LicensureName	Optional Repeatable	Free-form name of license or certification.	Optional	minOcc 0 maxOcc ∞ minLength 1 maxLength 60
LicensurePassageDate	Optional Repeatable	Date of licensure or certification passage	Optional	minOcc 0 maxOcc ∞ xs:date
Comment: The format for date is ccyy-mm-dd.				
NoteMessage	Optional Repeatable	Additional information about the licensure	Not Recommended	minOcc 0 maxOcc ∞ minLength 1 maxLength 80
Comment: This would be unusual to appear on a high school transcript. However, if the student has received a licensure or certification that was not directly related to a course taken at the school, this would be the place to include it. Some unusual possibilities of this might be a certification in American Sign Language, Computer Repair, Life Saving, etc.				

Code illustration:

```

<Licensure>
  <LicensureName>American Red Cross Life Saving Certification</LicensureName>
  <LicensurePassageDate>2004-05-20</LicensurePassageDate>
  <NoteMessage />
</Licensure>
    
```

Student.Health

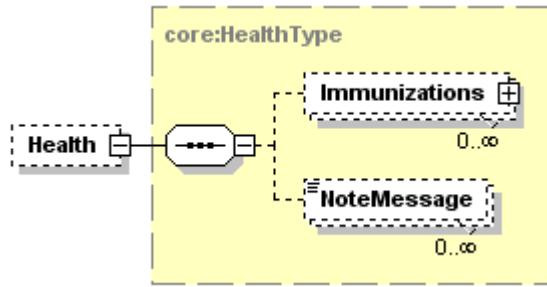

Tag Name	Schema Use	Description	Recommended Use	Format
Immunizations	Optional Repeatable	Information about immunizations	Recommended	minOcc 0 maxOcc ∞
NoteMessage	Optional Repeatable	Additional information about immunizations	Not Recommended	minOcc 0 maxOcc ∞ minLength 1 maxLength 80

Comment: Since many secondary schools maintain immunization records, if the data are available, the inclusion of the data might assist the receiving institution in satisfying an immunization requirement at that school.

Code illustration:

```
<Health>
  <Immunizations>

  </Immunizations>
  <NoteMessage />
</Health>
```

Student.Health.Immunizations

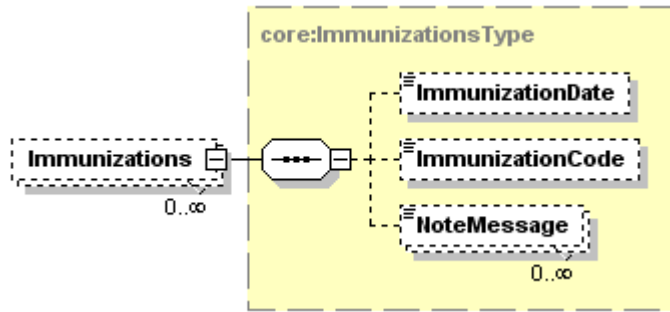

Tag Name	Schema Use	Description	Recommended Use	Format
ImmunizationDate	Optional	Date of immunization	Recommended	minOcc 0 maxOcc 1 xs:date
Comment: The format for date is ccyy-mm-dd.				
ImmunizationCode	Optional	Medical immunization or vaccine code from the Current Procedural Terminology (CPT) 2002 of the American Medical Association.	Recommended	minOcc 0 maxOcc 1 minLength 1 maxLength 20
NoteMessage	Optional Repeatable	Additional information about the immunization	Not Recommended	minOcc 0 maxOcc ∞ minLength 1 maxLength 80

Code illustration:

```

<Immunizations>
  <ImmunizationDate>2005-04-30</ImmunizationDate>
  <ImmunizationCode>90705</ImmunizationCode>
  <NoteMessage />
</Immunizations>
    
```

Student.Tests

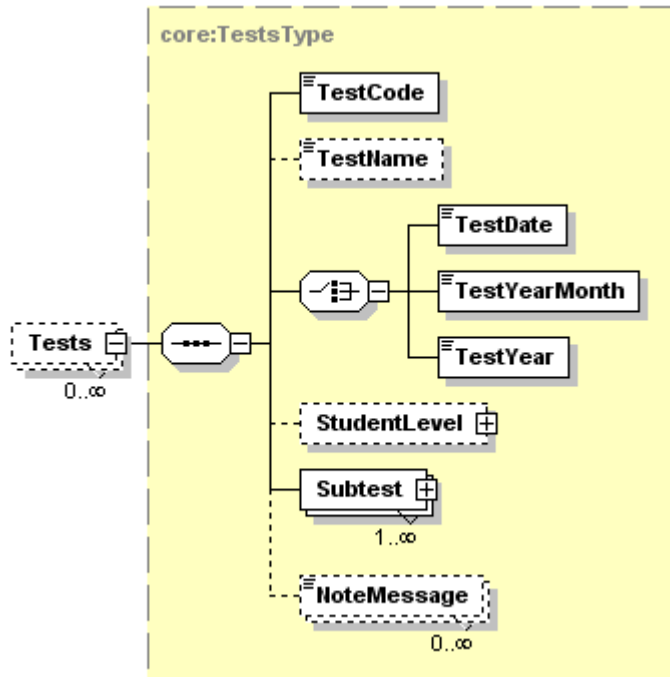

Tag Name	Schema Use	Description	Recommended Use	Format
TestCode	Required	Code identifying the test	Required	minOcc 1 maxOcc 1 See Appendix C
TestName	Optional	Name identifying the test	Recommended	minOcc 0 maxOcc 1 See Appendix C
TestDate	Required choice	Date of the test	Required (use one)	minOcc 1 maxOcc 1 xs:date
Comment: Use this choice if the exact date of the test is known. Format for date is ccyy-mm-dd.				
TestYearMonth	Required choice	Date of the test	Required (use one)	minOcc 1 maxOcc 1 ccyy-mm
Comment: Use this choice if only the year and the month of the test are known.				
TestYear	Required choice	Date of the test	Required (use one)	minOcc 1 maxOcc 1 ccyy
Comment: Use this choice if only the year of the test is known.				
Comment: If you include the complex data element "Tests" in the Schema, then you must include one of the above three date formats.				
StudentLevel	Optional	The classification of the student at the time the student took the test	Not Recommended	minOcc 0 maxOcc 1
Subtest	Required Repeatable	Subdivision of a standardized test (including the score)	Required	minOcc 1 maxOcc ∞
Comment: This complex data element will be expanded on page XXX which follows.				

Tag Name	Schema Use	Description	Recommended Use	Format
NoteMessage	Optional Repeatable	Additional information about the test	Not Recommended	minOcc 0 maxOcc ∞ minLength 1 maxLength 80

Code illustration:

```

<Tests>
  <TestCode>809</TestCode>
  <TestName>TEST OF ENGLISH AS A FOREIGN LANGUAGE (TOEFL)</TestName>
  <TestYearMonth>1988-04</TestYearMonth>
  <StudentLevel>

  </StudentLevel>
  <Subtest>

  </Subtest>
  <NoteMessage />
</Tests>
    
```

Student.Tests.StudentLevel

Note: Although the complex data element StudentLevel is an optional data element, if you choose to send the StudentLevel for the test, then you must send the StudentLevelCode.

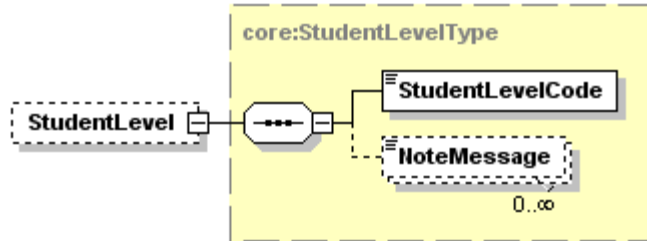

Tag Name	Schema Use	Description	Recommended Use	Format
StudentLevelCode	Required	The classification of the student at the time the student took the test	Required	minOcc 1 maxOcc 1 Enumerations: SeventhGrade EighthGrade NinthGrade TenthGrade EleventhGrade TwelfthGrade
NoteMessage	Optional Repeatable	Additional information about the student level	Not Recommended	minOcc 0 maxOcc ∞ minLength 1 maxLength 80

Code illustration:

```
<StudentLevel>
  <StudentLevelCode>NinthGrade</StudentLevelCode>
  <NoteMessage />
</StudentLevel>
```

Student.Tests.Subtest

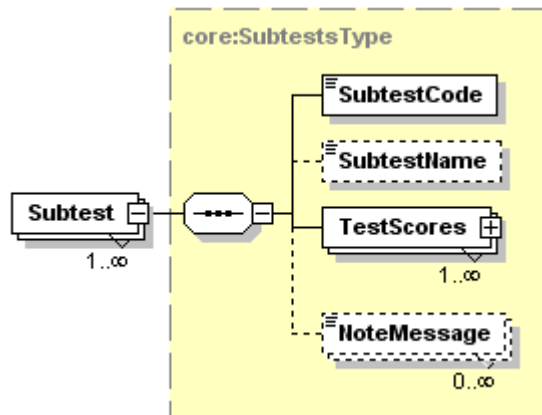

Tag Name	Schema Use	Description	Recommended Use	Format
SubtestCode	Required	Code identifying the sub-part of a standardized test (e.g. Quantitative, Verbal)	Required	minOcc 1 maxOcc 1 See Appendix D
SubtestName	Optional	Name of the sub-part of a standardized test	Recommended	minOcc 0 maxOcc 1 See Appendix D
TestScores	Required Repeatable	The score received on the test	Required	minOcc 1 maxOcc ∞
NoteMessage	Optional Repeatable	Additional information about the subtest	Not Recommended	minOcc 0 maxOcc ∞ minLength 1 maxLength 80

Code illustration:

```

<Subtest>
  <SubtestCode>00001</SubtestCode>
  <SubtestName>Listening Comprehension</SubtestName>
  <TestScores>
    </TestScores>
  <NoteMessage />
</Subtest>
    
```

Student.Tests.Subtest.TestScores

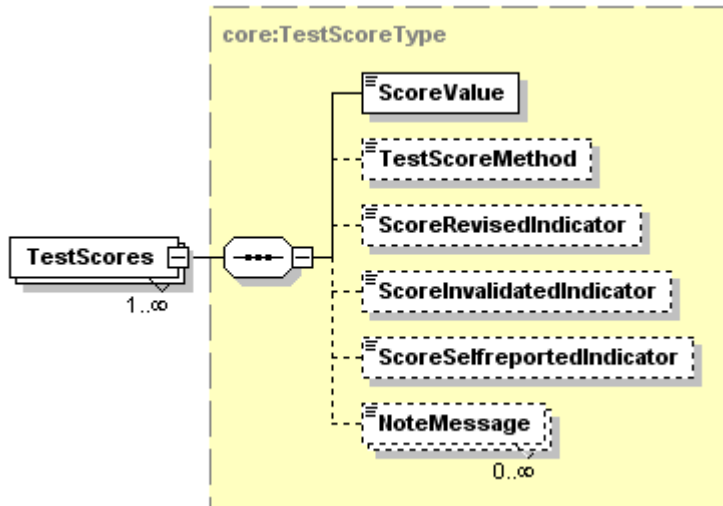

Tag Name	Schema Use	Description	Recommended Use	Format
ScoreValue	Required	The actual value of the score received on the test	Required	minOcc 1 maxOcc 1 minLength 1 maxLength 80
TestScoreMethod	Optional	Code identifying the method used to measure and report the test scores. <i>Scaled</i> - Scaled Score <i>Graded</i> - Grade Equivalent or Grade Level Indicator <i>Standard</i> - Standard Score <i>Raw</i> - Raw Score <i>Percent</i> - Percent of Items Correct <i>Mastery</i> - Mastery Score <i>Adjective</i> - Adjective Classification or locally Defined Score <i>Stanine</i> - Stanine <i>Percentile</i> - Percentile <i>NormalCurve</i> - Normal Curve <i>Equivalent</i> <i>Equated</i> - Equated Score (pre-test and post-test were different) <i>Local</i> - Locally Defined	Optional	minOcc 0 maxOcc 1 Enumerations: Scaled Graded Standard Raw Percent Mastery Adjective Stanine Percentile NormalCurve Equated Local
ScoreRevisedIndicator	Optional	Indicates if the score report has been revised. If true, score may differ from score previously reported for this test and test date.	Optional	minOcc 0 maxOcc 1 true false
Comment: If this is a revision of a previous score report, then include the data element with a value of "true". If it is not a revised score report, do not include this data element.				
ScoreInvalidatedIndicator	Optional	Indicates if the score has been invalidated. If true, score previously reported for this test and test date is not valid.	Optional	minOcc 0 maxOcc 1 true false
Comment: If this score report is reporting that the test score has been invalidated, then include the data element with a value of "true". If not, then do not include this data element.				

Tag Name	Schema Use	Description	Recommended Use	Format
ScoreSelfreportedIndicator	Optional	Indicates if the score has been self-reported by the student.	Optional	minOcc 0 maxOcc 1 true false
Comment: If this is a score report that was self reported by the student, then include the data element with a value of "true". If not, then do not include this data element.				
NoteMessage	Optional Repeatable	Additional information about the test score	Not Recommended	minOcc 0 maxOcc ∞ minLength 1 maxLength 80

Code illustration:

```

<TestScores>
  <ScoreValue>25</ScoreValue>
  <TestScoreMethod>Scaled</TestScoreMethod>
  <ScoreRevisedIndicator>true</ScoreRevisedIndicator>
  <ScoreInvalidatedIndicator/>
  <ScoreSelfreportedIndicator/>
  <NoteMessage/>
</TestScores>
    
```

End of PESC XML High School Transcript Schema

Appendix A State and Province Codes Sorted by State and Province Codes	
State and Province Code	State and Province Name
AA	Military – Americas
AB	Alberta
AE	Military – Europe
AK	Alaska
AL	Alabama
AP	Military – Pacific
AR	Arkansas
AS	American Samoa
AZ	Arizona
BC	British Columbia
CA	California
CO	Colorado
CT	Connecticut
CZ	Canal Zone
DC	District of Columbia
DE	Delaware
FL	Florida
FM	Federated States of Micronesia
GA	Georgia
GU	Guam
HI	Hawaii
IA	Iowa
ID	Idaho
IL	Illinois
IN	Indiana
KS	Kansas
KY	Kentucky
LA	Louisiana
MA	Massachusetts
MB	Manitoba
MD	Maryland
ME	Maine
MH	Marshall Islands
MI	Michigan
MN	Minnesota
MO	Missouri
MP	Northern Mariana Islands
MS	Mississippi

Appendix A State and Province Codes Sorted by State and Province Codes	
State and Province Code	State and Province Name
MT	Montana
NB	New Brunswick
NC	North Carolina
ND	North Dakota
NE	Nebraska
NF	Newfoundland
NH	New Hampshire
NJ	New Jersey
NL	Newfoundland and Labrador
NM	New Mexico
NS	Nova Scotia
NT	Northwest Territories
NU	Nunavut
NV	Nevada
NY	New York
OH	Ohio
OK	Oklahoma
ON	Ontario
OR	Oregon
PA	Pennsylvania
PE	Prince Edward Island
PR	Puerto Rico
PW	Republic of Palau
QC	Quebec
RI	Rhode Island
SC	South Carolina
SD	South Dakota
SK	Saskatchewan
TN	Tennessee
TX	Texas
UT	Utah
VA	Virginia
VI	Virgin Islands
VT	Vermont
WA	Washington
WI	Wisconsin
WV	West Virginia
WY	Wyoming
YT	Yukon

Appendix B

Country Codes

ISO 3166-1 Alpha-2 Standard (as of April 2007)

Not to be used for US SEVIS Purposes

Sorted by Code

CountryCode Description

AD	Andorra
AE	United Arab Emirates
AF	Afghanistan
AG	Antigua And Barbuda
AI	Anguilla
AL	Albania
AM	Armenia
AN	Netherlands Antilles
AO	Angola
AQ	Antarctica
AR	Argentina
AS	American Samoa
AT	Austria
AU	Australia
AW	Aruba
AX	Åland Islands
AZ	Azerbaijan
BA	Bosnia And Herzegovina
BB	Barbados
BD	Bangladesh
BE	Belgium
BF	Burkina Faso
BG	Bulgaria
BH	Bahrain
BI	Burundi
BJ	Benin
BM	Bermuda
BN	Brunei Darussalam
BO	Bolivia
BR	Brazil
BS	Bahamas
BT	Bhutan
BV	Bouvet Island
BW	Botswana
BY	Belarus
BZ	Belize
CA	Canada
CC	Cocos (Keeling) Islands

**Appendix B
Country Codes**

ISO 3166-1 Alpha-2 Standard (as of April 2007)

Not to be used for US SEVIS Purposes

Sorted by Code

CountryCode	Description
CD	Congo, The Democratic Republic Of The
CF	Central African Republic
CG	Congo
CH	Switzerland
CI	Cote D'ivoire
CK	Cook Islands
CL	Chile
CM	Cameroon
CN	China
CO	Colombia
CR	Costa Rica
CS	Serbia And Montenegro (Deleted as of April 2007 – see ME and RS) *
CU	Cuba
CV	Cape Verde
CX	Christmas Island
CY	Cyprus
CZ	Czech Republic
DE	Germany
DJ	Djibouti
DK	Denmark
DM	Dominica
DO	Dominican Republic
DZ	Algeria
EC	Ecuador
EE	Estonia
EG	Egypt
EH	Western Sahara
ER	Eritrea
ES	Spain
ET	Ethiopia
FI	Finland
FJ	Fiji
FK	Falkland Islands (Malvinas)
FM	Micronesia, Federated States Of
FO	Faroe Islands
FR	France
GA	Gabon
GB	United Kingdom
GD	Grenada

Appendix B
Country Codes
ISO 3166-1 Alpha-2 Standard (as of April 2007)
Not to be used for US SEVIS Purposes
Sorted by Code

CountryCode	Description
-------------	-------------

GE	Georgia
GF	French Guiana
GG	Guernsey *
GH	Ghana
GI	Gibraltar
GL	Greenland
GM	Gambia
GN	Guinea
GP	Guadeloupe
GQ	Equatorial Guinea
GR	Greece
GS	South Georgia And The South Sandwich Islands
GT	Guatemala
GU	Guam
GW	Guinea Bissau
GY	Guyana
HK	Hong Kong
HM	Heard Island And Mcdonald Islands
HN	Honduras
HR	Croatia
HT	Haiti
HU	Hungary
ID	Indonesia
IE	Ireland
IL	Israel
IM	Isle of Man *
IN	India
IO	British Indian Ocean Territory
IQ	Iraq
IR	Iran, Islamic Republic Of
IS	Iceland
IT	Italy
JE	Jersey *
JM	Jamaica
JO	Jordan
JP	Japan
KE	Kenya
KG	Kyrgyzstan
KH	Cambodia

**Appendix B
Country Codes**

ISO 3166-1 Alpha-2 Standard (as of April 2007)

Not to be used for US SEVIS Purposes

Sorted by Code

CountryCode	Description
KI	Kiribati
KM	Comoros
KN	Saint Kitts And Nevis
KP	Korea, Democratic People's Republic Of
KR	Korea, Republic Of
KW	Kuwait
KY	Cayman Islands
KZ	Kazakhstan
LA	Lao People's Democratic Republic
LB	Lebanon
LC	Saint Lucia
LI	Liechtenstein
LK	Sri Lanka
LR	Liberia
LS	Lesotho
LT	Lithuania
LU	Luxembourg
LV	Latvia
LY	Libyan Arab Jamahiriya
MA	Morocco
MC	Monaco
MD	Moldova, Republic Of
ME	Montenegro *
MG	Madagascar
MH	Marshall Islands
MK	Macedonia, The Former Yugoslav Republic Of
ML	Mali
MM	Myanmar
MN	Mongolia
MO	Macao
MP	Northern Mariana Islands
MQ	Martinique
MR	Mauritania
MS	Montserrat
MT	Malta
MU	Mauritius
MV	Maldives
MW	Malawi
MX	Mexico

**Appendix B
Country Codes**

ISO 3166-1 Alpha-2 Standard (as of April 2007)

Not to be used for US SEVIS Purposes

Sorted by Code

CountryCode	Description
MY	Malaysia
MZ	Mozambique
NA	Namibia
NC	New Caledonia
NE	Niger
NF	Norfolk Island
NG	Nigeria
NI	Nicaragua
NL	Netherlands
NO	Norway
NP	Nepal
NR	Nauru
NU	Niue
NZ	New Zealand
OM	Oman
PA	Panama
PE	Peru
PF	French Polynesia
PG	Papua New Guinea
PH	Philippines
PK	Pakistan
PL	Poland
PM	Saint Pierre And Miquelon
PN	Pitcairn
PR	Puerto Rico
PS	Palestinian Territory, Occupied
PT	Portugal
PW	Palau
PY	Paraguay
QA	Qatar
RE	Reunion
RO	Romania
RS	Serbia *
RU	Russian Federation
RW	Rwanda
SA	Saudi Arabia
SB	Solomon Islands
SC	Seychelles
SD	Sudan

**Appendix B
Country Codes**

ISO 3166-1 Alpha-2 Standard (as of April 2007)

Not to be used for US SEVIS Purposes

Sorted by Code

CountryCode	Description
SE	Sweden
SG	Singapore
SH	Saint Helena
SI	Slovenia
SJ	Svalbard And Jan Mayen
SK	Slovakia
SL	Sierra Leone
SM	San Marino
SN	Senegal
SO	Somalia
SR	Suriname
ST	Sao Tome And Principe
SV	El Salvador
SY	Syrian Arab Republic
SZ	Swaziland
TC	Turks And Caicos Islands
TD	Chad
TF	French Southern Territories
TG	Togo
TH	Thailand
TJ	Tajikistan
TK	Tokelau
TL	Timor Leste
TM	Turkmenistan
TN	Tunisia
TO	Tonga
TR	Turkey
TT	Trinidad And Tobago
TV	Tuvalu
TW	Taiwan, Province Of China
TZ	Tanzania, United Republic Of
UA	Ukraine
UG	Uganda
UM	United States Minor Outlying Islands
US	United States
UY	Uruguay
UZ	Uzbekistan
VA	Holy See (Vatican City State)
VC	Saint Vincent And The Grenadines

**Appendix B
Country Codes**

ISO 3166-1 Alpha-2 Standard (as of April 2007)

Not to be used for US SEVIS Purposes

Sorted by Code

CountryCode	Description
VE	Venezuela
VG	Virgin Islands, British
VI	Virgin Islands, U.S.
VN	Viet Nam
VU	Vanuatu
WF	Wallis And Futuna
WS	Samoa
YE	Yemen
YT	Mayotte
ZA	South Africa
ZM	Zambia
ZW	Zimbabwe

* Updated as of April 2007

**Appendix B
Country Codes**

ISO 3166-1 Alpha-2 Standard (as of April 2007)

Not to be used for US SEVIS Purposes

Sorted by Country Name

CountryCode	Description
--------------------	--------------------

AD	Andorra
AF	Afghanistan
AX	Åland Islands
AL	Albania
DZ	Algeria
AS	American Samoa
AO	Angola
AI	Anguilla
AQ	Antarctica
AG	Antigua And Barbuda
AR	Argentina
AM	Armenia
AW	Aruba
AU	Australia
AT	Austria
AZ	Azerbaijan
BS	Bahamas
BH	Bahrain
BD	Bangladesh
BB	Barbados
BY	Belarus
BE	Belgium
BZ	Belize
BJ	Benin
BM	Bermuda
BT	Bhutan
BO	Bolivia
BA	Bosnia And Herzegovina
BW	Botswana
BV	Bouvet Island
BR	Brazil
IO	British Indian Ocean Territory
BN	Brunei Darussalam
BG	Bulgaria
BF	Burkina Faso
BI	Burundi
KH	Cambodia
CM	Cameroon
CA	Canada

**Appendix B
Country Codes**

ISO 3166-1 Alpha-2 Standard (as of April 2007)

Not to be used for US SEVIS Purposes

Sorted by Country Name

CountryCode	Description
--------------------	--------------------

CV	Cape Verde
KY	Cayman Islands
CF	Central African Republic
TD	Chad
CL	Chile
CN	China
CX	Christmas Island
CC	Cocos (Keeling) Islands
CO	Colombia
KM	Comoros
CG	Congo
CD	Congo, The Democratic Republic Of The
CK	Cook Islands
CR	Costa Rica
CI	Cote D'ivoire
HR	Croatia
CU	Cuba
CY	Cyprus
CZ	Czech Republic
DK	Denmark
DJ	Djibouti
DM	Dominica
DO	Dominican Republic
EC	Ecuador
EG	Egypt
SV	El Salvador
GQ	Equatorial Guinea
ER	Eritrea
EE	Estonia
ET	Ethiopia
FK	Falkland Islands (Malvinas)
FO	Faroe Islands
FJ	Fiji
FI	Finland
FR	France
GF	French Guiana
PF	French Polynesia
TF	French Southern Territories
GA	Gabon
GM	Gambia
GE	Georgia

Appendix B Country Codes

ISO 3166-1 Alpha-2 Standard (as of April 2007)

Not to be used for US SEVIS Purposes

Sorted by Country Name

CountryCode	Description
DE	Germany
GH	Ghana
GI	Gibraltar
GR	Greece
GL	Greenland
GD	Grenada
GP	Guadeloupe
GU	Guam
GT	Guatemala
GG	Guernsey *
GN	Guinea
GW	Guinea Bissau
GY	Guyana
HT	Haiti
HM	Heard Island And Mcdonald Islands
VA	Holy See (Vatican City State)
HN	Honduras
HK	Hong Kong
HU	Hungary
IS	Iceland
IN	India
ID	Indonesia
IR	Iran, Islamic Republic Of
IQ	Iraq
IE	Ireland
IM	Isle of Man *
IL	Israel
IT	Italy
JM	Jamaica
JP	Japan
JE	Jersey *
JO	Jordan
KZ	Kazakhstan
KE	Kenya
KI	Kiribati
KP	Korea, Democratic People's Republic Of
KR	Korea, Republic Of
KW	Kuwait
KG	Kyrgyzstan
LA	Lao People's Democratic Republic
LV	Latvia

**Appendix B
Country Codes**

ISO 3166-1 Alpha-2 Standard (as of April 2007)

Not to be used for US SEVIS Purposes

Sorted by Country Name

CountryCode	Description
--------------------	--------------------

LB	Lebanon
LS	Lesotho
LR	Liberia
LY	Libyan Arab Jamahiriya
LI	Liechtenstein
LT	Lithuania
LU	Luxembourg
MO	Macao
MK	Macedonia, The Former Yugoslav Republic Of
MG	Madagascar
MW	Malawi
MY	Malaysia
MV	Maldives
ML	Mali
MT	Malta
MH	Marshall Islands
MQ	Martinique
MR	Mauritania
MU	Mauritius
YT	Mayotte
MX	Mexico
FM	Micronesia, Federated States Of
MD	Moldova, Republic Of
MC	Monaco
MN	Mongolia
ME	Montenegro *
MS	Montserrat
MA	Morocco
MZ	Mozambique
MM	Myanmar
NA	Namibia
NR	Nauru
NP	Nepal
NL	Netherlands
AN	Netherlands Antilles
NC	New Caledonia
NZ	New Zealand
NI	Nicaragua
NE	Niger
NG	Nigeria
NU	Niue

**Appendix B
Country Codes**

ISO 3166-1 Alpha-2 Standard (as of April 2007)

Not to be used for US SEVIS Purposes

Sorted by Country Name

CountryCode	Description
--------------------	--------------------

NF	Norfolk Island
MP	Northern Mariana Islands
NO	Norway
OM	Oman
PK	Pakistan
PW	Palau
PS	Palestinian Territory, Occupied
PA	Panama
PG	Papua New Guinea
PY	Paraguay
PE	Peru
PH	Philippines
PN	Pitcairn
PL	Poland
PT	Portugal
PR	Puerto Rico
QA	Qatar
RE	Reunion
RO	Romania
RU	Russian Federation
RW	Rwanda
SH	Saint Helena
KN	Saint Kitts And Nevis
LC	Saint Lucia
PM	Saint Pierre And Miquelon
VC	Saint Vincent And The Grenadines
WS	Samoa
SM	San Marino
ST	Sao Tome And Principe
SA	Saudi Arabia
SN	Senegal
RS	Serbia *
CS	Serbia And Montenegro (Deleted as of April 2007 – see ME and RS) *
SC	Seychelles
SL	Sierra Leone
SG	Singapore
SK	Slovakia
SI	Slovenia
SB	Solomon Islands
SO	Somalia
ZA	South Africa

**Appendix B
Country Codes**

ISO 3166-1 Alpha-2 Standard (as of April 2007)

Not to be used for US SEVIS Purposes

Sorted by Country Name

CountryCode	Description
GS	South Georgia And The South Sandwich Islands
ES	Spain
LK	Sri Lanka
SD	Sudan
SR	Suriname
SJ	Svalbard And Jan Mayen
SZ	Swaziland
SE	Sweden
CH	Switzerland
SY	Syrian Arab Republic
TW	Taiwan, Province Of China
TJ	Tajikistan
TZ	Tanzania, United Republic Of
TH	Thailand
TL	Timor Leste
TG	Togo
TK	Tokelau
TO	Tonga
TT	Trinidad And Tobago
TN	Tunisia
TR	Turkey
TM	Turkmenistan
TC	Turks And Caicos Islands
TV	Tuvalu
UG	Uganda
UA	Ukraine
AE	United Arab Emirates
GB	United Kingdom
US	United States
UM	United States Minor Outlying Islands
UY	Uruguay
UZ	Uzbekistan
VU	Vanuatu
VE	Venezuela
VN	Viet Nam
VG	Virgin Islands, British
VI	Virgin Islands, U.S.
WF	Wallis And Futuna
EH	Western Sahara
YE	Yemen
ZM	Zambia

**Appendix B
Country Codes**

ISO 3166-1 Alpha-2 Standard (as of April 2007)

Not to be used for US SEVIS Purposes

Sorted by Country Name

CountryCode	Description
--------------------	--------------------

ZW	Zimbabwe
----	----------

* Updated as of April 2007

Appendix C – TestCode and TestName

TestCode	TestName	TestCode	TestName
1	California Achievement Tests, 1977	815	Dental Admissions Test
2	California Achievement Tests, 1985	816	Optometry Admissions Test
3	California Achievement Tests, 1986	817	Allied Health Professions Admission Test (AHPAT)
4	Comprehensive Assessment Program Achievement Series, 1980	818	College Level Examination Program (CLEP)
5	Comprehensive Tests of Basic Skills, 1981		General Examinations
6	Comprehensive Tests of Basic Skills, 1988	819	College Level Examination Program (CLEP) Subject Examinations
7	Iowa Tests of Basic Skills, 1978	821	Graduate Record Examination (GRE) General Test
8	Iowa Tests of Basic Skills, 1985	822	Graduate Record Examination (GRE) Subject Tests
9	Tests of Achievement and Proficiency, 1978	826	Pre-Professional Skills Test (PPST)
10	Tests of Achievement and Proficiency, 1985	828	Test of Spoken English (TSE)
11	Metropolitan Achievement Tests, 1978	829	Test of Written English (TWE)
12	Metropolitan Achievement Tests, 1985	830	Veterinary College Admission Test (VCAT)
13	Metropolitan Language Instructional Tests, 1979	831	College Board's Advanced Placement Program (AP)
14	Metropolitan Reading Instructional Tests, 1979	9AK	Alaska State Adopted Test or Requirement
15	National Tests of Basic Skills, 1985	9AL	Alabama State Adopted Test or Requirement
16	National Tests of Basic Skills, 1986	9AR	Arkansas State Adopted Test or Requirement
17	National Achievement Tests Comprehensive Assessment Program, 1989	9AZ	Arizona State Adopted Test or Requirement
18	Science Research Associates Achievement Tests, 1978	9CA	California State Adopted Test or Requirement
19	Science Research Associates Survey of Basic Skills, 1985	9CO	Colorado State Adopted Test or Requirement
20	Stanford Diagnostic Reading Test, 1984	9CT	Connecticut State Adopted Test or Requirement
21	Stanford Achievement Tests, 1982	9DC	District of Columbia State Adopted Test or Requirement
22	Stanford Achievement Tests, 1987	9DE	Delaware State Adopted Test or Requirement
23	Stanford Achievement Tests, 1988	9FL	Florida State Adopted Test or Requirement
24	Stanford Test of Academic Skills, 1982	9GA	Georgia State Adopted Test or Requirement
25	Stanford Test of Academic Skills, 1987	9HI	Hawaii State Adopted Test or Requirement
26	Stanford Test of Academic Skills, 1988	9IA	Iowa State Adopted Test or Requirement
27	Sequential Tests of Educational Progress, 1979	9ID	Idaho State Adopted Test or Requirement
28	The 3 R's Test, 1982	9IL	Illinois State Adopted Test or Requirement
29	California Achievement Tests	9IN	Indiana State Adopted Test or Requirement
30	Comprehensive Assessment Program Achievement Series	9KS	Kansas State Adopted Test or Requirement
31	Comprehensive Tests of Basic Skills	9KY	Kentucky State Adopted Test or Requirement
32	Iowa Tests of Basic Skills	9LA	Louisiana State Adopted Test or Requirement
33	Tests of Achievement and Proficiency	9MA	Massachusetts State Adopted Test or Requirement
34	Metropolitan Achievement Tests	9MD	Maryland State Adopted Test or Requirement
35	Metropolitan Language Instructional Tests	9ME	Maine State Adopted Test or Requirement
36	Metropolitan Reading Instructional Tests	9MI	Michigan State Adopted Test or Requirement
37	National Tests of Basic Skills	9MN	Minnesota State Adopted Test or Requirement
38	National Achievement Tests Comprehensive Assessment Program	9MO	Missouri State Adopted Test or Requirement
39	Science Research Associates Achievement Tests	9MS	Mississippi State Adopted Test or Requirement
40	Science Research Associates Survey of Basic Skills	9MT	Montana State Adopted Test or Requirement
41	Stanford Diagnostic Reading Test	9NC	North Carolina State Adopted Test or Requirement
42	Stanford Achievement Tests	9ND	North Dakota State Adopted Test or Requirement
43	Stanford Test of Academic Skills	9NE	Nebraska State Adopted Test or Requirement
44	Sequential Tests of Educational Progress	9NH	New Hampshire State Adopted Test or Requirement
45	The 3 R's Test	9NJ	New Jersey State Adopted Test or Requirement
46	Iowa Test of Educational Development (Grades 9-12)	9NM	New Mexico State Adopted Test or Requirement
555	Local/District Adopted Test	9NV	Nevada State Adopted Test or Requirement
801	American College Testing Program (ACT)	9NY	New York State Adopted Test or Requirement
802	Preliminary American College Testing (PACT)	9OH	Ohio State Adopted Test or Requirement
803	College Board's Scholastic Aptitude Test (SAT I)	9OK	Oklahoma State Adopted Test or Requirement
	Preliminary Scholastic Aptitude Test/ National Merit Scholarship Qualifying Test (PSAT/NMSQT)	9OR	Oregon State Adopted Test or Requirement
804	College Board's Achievement Tests (SAT II)	9PA	Pennsylvania State Adopted Test or Requirement
805	Test of Adult Basic Education (TABE)	9RI	Rhode Island State Adopted Test or Requirement
806	International Baccalaureate (IB)	9SC	South Carolina State Adopted Test or Requirement
807	General Education Development (GED)	9SD	South Dakota State Adopted Test or Requirement
808	Test of English as a Foreign Language (TOEFL)	9TN	Tennessee State Adopted Test or Requirement
809	Graduate Management Admissions Test (GMAT)	9TX	Texas State Adopted Test or Requirement
810	Law School Admissions Test (LSAT)	9UT	Utah State Adopted Test or Requirement
811	Miller Analogies Test	9VA	Virginia State Adopted Test or Requirement
812	Medical Colleges Aptitude Test (MCAT)	9VT	Vermont State Adopted Test or Requirement
813		9WA	Washington State Adopted Test or Requirement
814		9WI	Wisconsin State Adopted Test or Requirement
		9WV	West Virginia State Adopted Test or Requirement
		9WY	Wyoming State Adopted Test or Requirement
		999	Other Tests Not Listed or Provided by Sender

Appendix D – SubtestCode and SubtestName

CALIFORNIA ACHIEVEMENT TESTS (Test codes 1, 2, 3, and 29)

00001 Vocabulary
00002 Reading Comprehension
00003 Reading Total
00004 Spelling
00005 Language Mechanics
00006 Language Expression
00007 Language Total
00008 Mathematics Computation
00009 Mathematics Concepts and Applications
00010 Mathematics Total
00011 Total Battery
00012 Study Skills
00013 Science
00014 Social Studies
00100 Complete Battery
00101 Basic Battery

COMPREHENSIVE TESTS OF BASIC SKILLS (Test codes 5, 6 and 31)

00001 Visual Recognition
00002 Sound Recognition
00003 Oral Comprehension
00004 Word Attack
00005 Vocabulary
00006 Total Reading Oral
00007 Reading Comprehension
00008 Spelling
00009 Language Mechanics
00010 Language Expression
00011 Total Language
00012 Mathematics Computation
00013 Mathematics Concepts and Applications
00014 Reference Skills
00015 Science
00016 Social Studies
00100 Complete Battery
00101 Basic Battery

IOWA TESTS OF BASIC SKILLS (Test codes 7, 8 and 32)

00001 Listening
00002 Word Analysis
00003 Vocabulary
00004 Reading Comprehension
00005 Spelling
00006 Capitalization
00007 Punctuation
00008 Usage and Expression
00009 Language Total
00010 Visual Materials
00011 Reference Materials
00012 Work-Study Skills
00013 Mathematics Concepts
00014 Mathematics Problems
00015 Mathematics Computation
00016 Science
00017 Materials Total
00018 Mathematics Total
00019 Social Studies
00100 Complete Battery
00101 Basic Battery

Appendix D – SubtestCode and SubtestName (Continued)

TESTS OF ACHIEVEMENT AND PROFICIENCY (Test codes 9, 10 and 33)

00001 Reading Comprehension
00002 Mathematics
00003 Written Expression
00004 Using Sources of Information
00005 Social Studies
00006 Science
00007 Applied Proficiency Skills
00008 Total Battery
00100 Complete Battery
00101 Basic Battery

METROPOLITAN ACHIEVEMENT TESTS (Test codes 11, 12 and 34)

00001 Vocabulary
00002 Word Recognition Skills
00003 Reading Comprehension
00004 Total Reading
00005 Mathematics: Concepts
00006 Mathematics: Problem Solving
00007 Mathematics: Computation
00008 Total Mathematics
00009 Spelling
00010 Language
00011 Total Language
00012 Science
00013 Social Studies
00014 Research Skills
00100 Complete Battery
00101 Basic Battery

NATIONAL TESTS OF BASIC SKILLS (Test codes 15, 16 and 37)

00001 Listening
00002 Word Analysis
00003 Vocabulary
00004 Reading Comprehension
00005 Spelling
00006 Capitalization
00007 Punctuation
00008 Usage and Expression
00009 Language Total
00010 Visual Materials
00011 Reference Materials
00012 Work-Study Skills
00013 Mathematics Concepts
00014 Mathematics Problems
00015 Mathematics Computation
00016 Science
00017 Social Studies
00100 Basic Battery
00101 Complete Battery

Appendix D – SubtestCode and SubtestName (Continued)

SCIENCE RESEARCH ASSOCIATES SURVEY OF BASIC SKILLS (Test codes 19 and 40)

- 00001 Reading Total
- 00002 Auditory Discrimination
- 00003 Letters and Sounds
- 00004 Decoding
- 00005 Listening Comprehension
- 00006 Vocabulary
- 00007 Reading Comprehension
- 00008 Language Arts
- 00009 Mechanics
- 00010 Usage
- 00011 Spelling
- 00012 Mathematics: Concepts/Problem Solving
- 00013 Mathematics: Computation
- 00014 Reference Materials
- 00015 Educational Ability Series
- 00016 Reading Comprehension
- 00017 Social Studies
- 00018 Science
- 00019 Survey of Applied Skills
- 00100 Complete Battery
- 00101 Basic Battery

STANFORD ACHIEVEMENT TESTS (Test codes 21, 22, 23 and 42)

- 00001 Listening
- 00002 Word Analysis
- 00003 Vocabulary
- 00004 Reading Comprehension
- 00005 Spelling
- 00006 Capitalization
- 00007 Punctuation
- 00008 Usage and Expression
- 00009 Language Total
- 00010 Visual Materials
- 00011 Reference Materials
- 00012 Work-Study Skills
- 00013 Mathematics Concepts
- 00014 Mathematics Problems
- 00015 Mathematics Computation
- 00016 Basic Battery
- 00017 Complete Battery
- 00018 Social Studies
- 00019 Science
- 00100 Complete Battery
- 00101 Basic Battery

STANFORD TEST OF ACADEMIC SKILLS (Test codes 24, 25, 26 and 43)

- 00001 Word Reading
- 00002 Reading Comprehension
- 00003 Auditory Discrimination
- 00004 Phonetic Analysis
- 00005 Structural Analysis
- 00006 Auditory Vocabulary
- 00007 Vocabulary
- 00008 Word Parts
- 00009 Reading Rate
- 00010 Scanning and Skimming
- 00011 Fast Reading
- 00012 Number System and Numeration
- 00013 Computation
- 00014 Applications
- 00015 Mathematics Total
- 00100 Complete Battery
- 00101 Basic Battery

Appendix D – SubtestCode and SubtestName (Continued)

THE 3 R'S TEST (Test codes 28 and 45)

- 00001 Listening
- 00002 Word Analysis
- 00003 Vocabulary
- 00004 Reading Comprehension
- 00005 Spelling
- 00006 Capitalization
- 00007 Punctuation
- 00008 Usage and Expression
- 00009 Language Total
- 00010 Visual Materials
- 00011 Reference Materials
- 00012 Work-Study Skills
- 00013 Mathematics Concepts
- 00014 Mathematics Problems
- 00015 Mathematics Computation
- 00016 Social Studies
- 00017 Science
- 00100 Complete Battery
- 00101 Basic Battery

IOWA TEST OF EDUCATIONAL DEVELOPMENT, GRADES 9-12 (Test code 46)

- 00001 Vocabulary
- 00002 Content Area Reading
- 00003 Reading Total
- 00004 Expression – Advanced
- 00005 Expression Total
- 00006 Quantitative Thinking
- 00007 Quantitative Thinking
- 00008 Core Total
- 00009 Literary Materials
- 00010 Social Studies
- 00011 Science
- 00012 Sources of Informatio
- 00013 Composite

AMERICAN COLLEGE TESTING PROGRAM (ACT) (Test code 801)

- 00001 English
- 00002 English: Usage/Mechanics
- 00003 English: Rhetorical Skills
- 00004 Mathematics
- 00005 Mathematics: Preliminary and Elementary Algebra
- 00006 Mathematics: Intermediate Algebra and Geometry
- 00007 Mathematics: Plane Geometry and Trigonometry
- 00008 Reading
- 00009 Reading: Social Studies and Science
- 00010 Reading: Arts and Literature
- 00011 Science Reasoning
- 00012 Composite

PRELIMINARY AMERICAN COLLEGE TESTING (Test code 802)

- 00001 English
- 00002 English: Usage and Mechanics
- 00003 English: Rhetorical Skills
- 00004 Mathematics
- 00005 Mathematics: Preliminary Algebra
- 00006 Mathematics: Geometry
- 00007 Reading
- 00008 Reading: Social Studies and Scie
- 00009 Reading: Arts and Literature
- 00010 Science Reasoning
- 00011 Composite

Appendix D – SubtestCode and SubtestName (Continued)

THE COLLEGE BOARD'S SCHOLASTIC APTITUDE TEST (SAT I) (Test code 803)

- 00001 Verbal
- 00002 Reading Comprehension
- 00003 Vocabulary
- 00004 Mathematical
- 00005 Total
- 00006 Test of Standard Written English (TSWE)

PRELIMINARY SCHOLASTIC APTITUDE TEST/NATIONAL MERIT SCHOLARSHIP QUALIFYING TEST (PSAT/NMSQT) (Test code 804)

- 00001 Verbal
- 00002 Mathematical
- 00003 Total

COLLEGE BOARD'S ACHIEVEMENT TESTS (SAT II) (Test code 805)

- 00001 English Composition
- 00002 Literature
- 00003 American History
- 00004 European History
- 00005 Mathematics I
- 00006 Mathematics II
- 00007 Biology
- 00008 Chemistry
- 00009 Physics
- 00010 French
- 00011 German
- 00012 Hebrew
- 00013 Latin
- 00014 Spanish
- 00015 World History
- 00016 French Listening
- 00017 Japanese with Listening
- 00018 German Listening
- 00019 Spanish Listening
- 00020 Chinese with Listening
- 00021 English Composition with Essay
- 00022 Italian
- 00023 Mathematics Level IC
- 00024 Mathematics Level IIC
- 00025 Modern Hebrew
- 00026 Writing

TEST OF ADULT BASIC EDUCATION (TABE) (Test code 806)

- 00001 Language Arts
- 00002 Mechanics
- 00003 Expression
- 00004 Reading
- 00005 Vocabulary
- 00006 Comprehension
- 00007 Mathematics
- 00008 Computation
- 00009 Concepts/Applications
- 00010 Spelling

INTERNATIONAL BACCALAUREATE (IB) (Test code 807)

- 00001 Biology
- 00002 Chemistry
- 00003 English A
- 00004 English B
- 00005 Foreign Language A
- 00006 Foreign Language B
- 00007 History (American)
- 00008 History (European)
- 00009 Mathematics
- 00010 Physics

Appendix D – SubtestCode and SubtestName (Continued)

GENERAL EDUCATION DEVELOPMENT (GED) (Test code 808)

- 00001 Mathematics
- 00002 Interpreting Literature and the Arts
- 00003 Science
- 00004 Social Studies
- 00005 Writing Skills

TEST OF ENGLISH AS A FOREIGN LANGUAGE (TOEFL) (Test code 809)

- 00001 Listening Comprehension
- 00002 Structure and Written Expression
- 00003 Vocabulary
- 00004 Total

GRADUATE MANAGEMENT ADMISSIONS TEST (GMAT) (Test code 811)

- 00001 Verbal
- 00002 Quantitative

LAW SCHOOL ADMISSIONS TEST (LSAT) (Test code 812)

- 00001 Reading Comprehension
- 00002 Analytical Reasoning
- 00003 Logical Reasoning
- 00004 Variable

MEDICAL COLLEGES ADMISSIONS TEST (MCAT) (Test code 814)

- 00001 Biology
- 00002 Chemistry
- 00003 Physics
- 00004 Science
- 00005 Reading
- 00006 Quantitative

DENTAL ADMISSIONS TEST (Test code 815)

- 00001 Quantitative Reasoning
- 00002 Reading
- 00003 Biology
- 00004 General Chemistry
- 00005 Organic Chemistry
- 00006 Perceptual Ability
- 00007 Survey of Natural Science
- 00008 Academic Average

OPTOMETRY ADMISSIONS TEST (Test code 816)

- 00001 Quantitative Reasoning
- 00002 Reading
- 00003 Biology
- 00004 General Chemistry
- 00005 Organic Chemistry
- 00006 General Physics
- 00007 Survey of Natural Science
- 00008 Academic Average

ALLIED HEALTH PROFESSIONS ADMISSION TEST (AHPAT) (Test code 817)

- 00001 Verbal Ability
- 00002 Quantitative Ability
- 00003 Biology
- 00004 Chemistry
- 00005 Reading Comprehension

COLLEGE LEVEL EXAMINATION PROGRAM (CLEP) GENERAL EXAMS (Test code 818)

- 00001 English Composition
- 00002 Humanities
- 00003 Mathematics
- 00004 Natural Sciences
- 00005 Social Sciences and History

Appendix D – SubtestCode and SubtestName (Continued)

COLLEGE LEVEL EXAMINATION PROGRAM (CLEP) SUBJECT EXAMS (Test code 819)

- 00001 American Government
- 00002 American History I: Early Colonization to 1877
- 00003 American History II: 1865 to Present
- 00004 General Psychology
- 00005 Human Growth and Development
- 00006 Introduction to Educational Psychology
- 00007 Introductory Macro Economics
- 00008 Introductory Micro Economics
- 00009 Introductory Sociology
- 00010 Western Civilization I: Ancient Near East to 1648
- 00011 Western Civilization II: 1648 to the Present
- 00012 College French: Levels 1 and 2
- 00013 College German: Levels 1 and 2
- 00014 College Spanish: Levels 1 and 2
- 00015 American Literature
- 00016 Analysis and Interpretation of Literature
- 00017 College Composition
- 00018 English Literature
- 00019 Freshman English
- 00020 Calculus with Elementary Functions
- 00021 College Algebra
- 00022 Trigonometry
- 00023 College Algebra with Trigonometry
- 00024 General Biology
- 00025 General Chemistry
- 00026 Information Systems and Computer Applications
- 00027 Introduction to Management
- 00028 Introductory Accounting
- 00029 Introductory Business Law
- 00030 Introductory Marketing

GRADUATE RECORD EXAMINATION (GRE) GENERAL TEST (Test code 821)

- 00001 Verbal
- 00002 Quantitative
- 00003 Analytical

GRADUATE RECORD EXAMINATION (GRE) SUBJECT TESTS (Test code 822)

- 00001 Biochemistry, Cell and Molecular Biology (B22)
- 00002 Biology (B24)
- 00003 Chemistry (C27)
- 00004 Computer Science (C29)
- 00005 Economics (E31)
- 00006 Education (E34)
- 00007 Engineering (E37)
- 00008 Geology (G47)
- 00009 History (H57)
- 00010 Literature in English (L64)
- 00011 Mathematics (M67)
- 00012 Revised Music (M72)
- 00013 Physics (P77)
- 00014 Political Science (P79)
- 00015 Psychology (P81)
- 00016 Sociology (S87)

PRE-PROFESSIONAL SKILLS TEST (PPST) (Test code 826)

- 00001 Reading
- 00002 Mathematics
- 00003 Writing
- 00004 Grammar
- 00005 Fluency
- 00006 Overall Comprehension

Appendix D – SubtestCode and SubtestName (Continued)

TEST OF SPOKEN ENGLISH (TSE) (Test code 828)

- 00001 Pronunciation
- 00002 Grammar
- 00003 Fluency
- 00004 Overall Comprehension

VETERINARY COLLEGE ADMISSION TEST (VCAT) (Test code 830)

- 00001 Verbal Ability
- 00002 Biology
- 00003 Chemistry
- 00004 Quantitative Ability
- 00005 Reading Comprehension

THE COLLEGE BOARD'S ADVANCED PLACEMENT PROGRAM (Test code 831)

- 00001 U.S. History
- 00002 Art History
- 00003 Art - Drawing
- 00004 Art - General
- 00005 Biology
- 00006 Chemistry
- 00007 Comp Sci - A
- 00008 Comp Sci - B
- 00009 Economics - Micro
- 00010 Economics - Macro
- 00011 English Language/Comp
- 00012 English Literature/Comp
- 00013 European History
- 00014 French Language
- 00015 French Literature
- 00016 German Language
- 00017 Govt & Pol - US
- 00018 Govt & Pol - Comp
- 00019 Latin - Vergil
- 00020 Latin - Cat Hor
- 00021 Calculus AB
- 00022 Calculus BC
- 00023 Music List & Lit
- 00024 Music Theory
- 00025 Physics
- 00026 Physics C - Mech
- 00027 Physics C - E & M
- 00028 Psychology
- 00029 Spanish Language
- 00030 Spanish Literature

Appendix E – CourseAcademicGradeScaleCode

I. Five or more passing grades (alpha with +/-)												
Code	Grades Used											
Wt	4.0	3.7	3.3	3.0	2.7	2.3	2.0	1.7	1.3	1.0	0.7	0.0
01	A	A-	B+	B	B-	C+	C	C-	D+	D	D-	F
02	A+,A	A-	B+	B	B-	C+	C	C-	D+	D	D-	F
03	A		B+	B		C+	C		D+	D		F
04	A+, A		B+	B		C+	C		D+	D		F
05	A+, A	A-	B+	B	B-	C+	C	C-	D+	D		F
06	A	A-	B+	B	B-	C+	C	C-				F
07	A		B+	B		C+	C			D		F
08	A	A-	B+	B	B-	C+	C	C-	D+	D		F
09	A	A-	B+	B	B-	C+	C	C-		D		F
10	A	A-	B+	B	B-	C+	C	C-	D+	D	D-	E/NC
11	A+, A	A-	B+	B	B-	C+	C	C-				
12	A+, A	A-	B+	B	B-	C+	C	C-	D+	D	D-	
13	A	A-	B+	B	B-	C+	C	C-	D+	D	D-	
14	Non-standard system using 5 or more alpha grades, no "F"											
15	Non-standard system using 5 or more alpha grades, and "F"											

II. ABCD/F with Halfstep Grades (AB, BC, etc.)									
Code	Grades Used								
Wt	4.0	3.5	3.0	2.5	2.0	1.5	1.0	0.5	0.0
16	A	AB	B	BC	C	CD	D	DF	F
17	A	AB	B	BC	C		D		F
18	A		B	C+	C		D		F
19	A	B+	B	C+	C	D+	D		F
20	A	B+	B	C+	C		D		F
21	A	B+	B	C+	C	C-	D		F
22	A+,A	B+	B	C+	C	D+	D		F
23	Other ABCDF system with halfstep grades, no "F" grade								
24	Other ABCDF system with halfstep grades and "F" grade								

Appendix E – CourseAcademicGradeScaleCode (Continued)

III. ABCD/F Type (4 passing letter grades)					
Code	Grades Used				
Wt	4.0	3.0	2.0	1.0	0.0
25	A	B	C	D	F
26	A	B	C	D	NC/N
27	A	B	C	D	E
28	H	S+	S	S-	U
29	E	S	M	I	F
30	DN	HP	P	HCO	NC
31	D	E	G	Q	U/F
32	H	E	G	P	U
33	S	H	P	LP	F
34	E	VG	G	P	F
35	HO	HP	PA	CR	NC
36	A	B	C	D	
37	A	B	C	D	U/R
38	Other ABCD/F type system, no "F" grade				
39	Other ABCD/F type system, with "F" grade				

IV. ABC/F Type (3 passing letter grades)				
Code	Grades Used			
Wt	4.0	3.0	2.0	0.0
40	A	B	C	F
41	H	HP	CR	NC
42	H	HP	P	F
43	A	B	C	NC
44	A	B	C	
45	H	HP	P	NP
46	HH	H	P	
47	HH	H	P	F
48	E	G	P	U/F
53	Other ABC/F type system, with no "F" grade			
54	Other ABC/F type system, with "F" grade			

Appendix E – CourseAcademicGradeScaleCode

V. Graduate School Grading Systems (not normally found in Manual)					
Code	Grades Used				
Wt	4.0	3.7	3.0	2.7	0.0
49	H	HP	P	LP	U/F
50	H	HP	P		F
51	DIST	HIGH PASS	PASS	LOW PASS	F
52	H	HP	P		U

VI. Pass/Fail Type (one or two passing grades)	
Code	Grades Used
Two passing grades, each converted to an American Medical Colleges Admissions Service (AMCAS) grade of "P"; failing grade converted to "N"	
55	Pass/Fail: HP and P, F
56	Pass/Fail: H and P, F
57	Pass/Fail: HP and P, N/NC
58	Pass/Fail: H and P, U
59	Other Pass/Fail types with two passing grades
One passing grade, converted to AMCAS grade of "P"; failing grade converted to AMCAS grade of "N"	
60	Pass/Fail: P, F
61	Pass/Fail: SAT, U
62	Pass/Fail: CR, NC
63	Pass/Fail: S, U
64	Other Pass/Fail types with one passing grade

Appendix E – CourseAcademicGradeScaleCode (Continued)

VII. Numeric - Percent Type												
Code	Grades Used											
Wt	4.0	3.7	3.3	3.0	2.7	2.3	2.0	1.7	1.3	1.0	0.7	0.0
65	100-93	92-90	89-87	86-83	82-80	79-77	76-73	72-70	69-67	66-63	62-60	59-0
66	100-90			89-80			79-70			69-60		59-0
67	100-94	93-90		89-85			84-75			74-70		69-0
68	100-90			89-80			79-70			69-65		64-0
69	100-93			92-85			84-77			76-70		69-0
70	100-93			92-84			83-75			74-70		69-0
71	100-90			89-80		79-76	75-70			69-60		59-0
72	100-90		89-85	84-80		79-75	74-70					69-0
73	Other numeric grading system - percent type											

VIII. Numeric - Percent Type												
Code	Grades Used											
Wt	4.0	3.7	3.3	3.0	2.7	2.3	2.0	1.7	1.3	1.0	0.7	0.0
74	4.0	3.7	3.3	3.0	2.7	2.3	2.0	1.7	1.3	1.0	0.7	0.0
77	1			2			3			4		5
79	4.0			3.0			2.0			1.0		0.0
80	1+,1	1-	2+	2	2-	3+	3	3-	4+	4	4-	5/6
81	3.0			2.0			1.0					0.0
82	Other numeric grading system - 4.0 or integer type											

IX. Numeric (4.0 type) Grading Systems using Halfstep Grades									
Code	Grades Used								
Wt	4.0	3.5	3.0	2.5	2.0	1.5	1.0	0.5	0.0
76	4.0	3.5	3.0	2.5	2.0	1.5	1.0	0.5	0.0
78	4.0	3.5	3.0	2.5	2.0		1.0		0.0
82	Other numeric grading system - 4.0 or integer type								
75	Continuous 4.0 scale (4.0 to 0.0)								

Appendix E – CourseAcademicGradeScaleCode (Continued)

X. Numeric - Canadian Type												
Code	Grades Used											
Wt	4.0	3.7	3.3	3.0	2.7	2.3	2.0	1.7	1.3	1.0	0.7	0.0
83	9	8	7		6	5		4	3			2,1
84	10,9	8	7		6	5		4	3	2	1	0
85	100-87	86-80	79-76	75-73	72-70	69-66	65-63	62-60	59-56	55-53	52-50	49-0
86	100-84	83-75	74-72	71-69	68-66	65-64	63-62	61-60	59-56	55-53	52-50	49-0
87	100-87	86-80	79-75	74-70	69-65	64-60	59-55	54-50				49-0
88	100-87	86-80	79-75	74-70	69-65	64-62	61-59	58-55	54-52	51-48	47-45	44-0
89	Other numeric grading system – Canadian											
99	Grading Scale Unknown											

Appendix F – Sample XML High School Transcript (with all courses taken at sending high school)

```

<?xml version="1.0" encoding="UTF-8"?>
<!-- edited with XMLSPY v5 rel. 4 U (http://www.xmlspy.com) by Bruce Robert Marton (The University of Texas at Austin) -->
<!-- Sample XML file generated by XMLSPY v5 rel. 4 U (http://www.xmlspy.com)-->
<HSTrn:HighSchoolTranscript xmlns:HSTrn="urn:org:pecs:message:HighSchoolTranscript:v1.0.0"
xmlns:AcRec="urn:org:pecs:sector:AcademicRecord:v1.1.0" xmlns:core="urn:org:pecs:core:CoreMain:v1.2.0"
xmlns:xsi="http://www.w3.org/2001/XMLSchema-instance" xsi:schemaLocation="urn:org:pecs:message:HighSchoolTranscript:v1.0.0
HighSchoolTranscript_v1.0.0.xsd">
  <TransmissionData>
    <DocumentID>2316139</DocumentID>
    <CreatedDateTime>2004-04-04T09:30:47-05:00</CreatedDateTime>
    <DocumentTypeCode>Request</DocumentTypeCode>
    <TransmissionType>Original</TransmissionType>
    <Source>
      <Organization>
        <CEEBACT>440320</CEEBACT>
        <LocalOrganizationID>
          <LocalOrganizationIDCode>227901002</LocalOrganizationIDCode>
          <LocalOrganizationIDQualifier>TX</LocalOrganizationIDQualifier>
        </LocalOrganizationID>
        <OrganizationName>Austin High School</OrganizationName>
        <OrganizationName>Austin Independent School District</OrganizationName>
        <Contacts>
          <Address>
            <AddressLine>1715 W Cesar Chavez</AddressLine>
            <City>Austin</City>
            <StateProvinceCode>TX</StateProvinceCode>
            <PostalCode>78703</PostalCode>
          </Address>
          <Phone>
            <AreaCityCode>512</AreaCityCode>
            <PhoneNumber>4142505</PhoneNumber>
          </Phone>
          <Phone>
            <AreaCityCode>512</AreaCityCode>
            <PhoneNumber>4747935</PhoneNumber>
            <NoteMessage>Fax</NoteMessage>
          </Phone>
        </Contacts>
      </Organization>
    </Source>
    <Destination>
      <Organization>
        <ATP>006882</ATP>
        <OrganizationName>THE UNIVERSITY OF TEXAS AT AUSTIN</OrganizationName>
        <Contacts>
          <Address>
            <AddressLine>Office of Admissions</AddressLine>
            <City>Austin</City>
            <StateProvinceCode>TX</StateProvinceCode>
            <PostalCode>78712</PostalCode>
          </Address>
          <Phone>
            <AreaCityCode>512</AreaCityCode>
            <PhoneNumber>4757638</PhoneNumber>
          </Phone>
        </Contacts>
      </Organization>
    </Destination>
  </TransmissionData>
  <Student>
    <Person>
      <SchoolAssignedPersonID>5555555</SchoolAssignedPersonID>
      <SSN>555555555</SSN>
      <Birth>
        <BirthDate>1987-07-20</BirthDate>
      </Birth>
    </Person>
  </Student>
</HSTrn:HighSchoolTranscript>

```

```

</Birth>
<Name>
  <FirstName>FirstName</FirstName>
  <MiddleName>Initial</MiddleName>
  <LastName>LastName</LastName>
</Name>
<ParentGuardianName>
  <FirstName>Parent-First-Name</FirstName>
  <LastName>Parent-Last-Name </LastName>
</ParentGuardianName>
<Contacts>
  <Address>
    <AddressLine>Street-Address</AddressLine>
    <City>AUSTIN</City>
    <StateProvinceCode>TX</StateProvinceCode>
    <PostalCode>78763</PostalCode>
  </Address>
  <Phone>
    <AreaCityCode>512</AreaCityCode>
    <PhoneNumber>8888888</PhoneNumber>
  </Phone>
</Contacts>
<Gender>
  <GenderCode>Male</GenderCode>
</Gender>

  <RaceEthnicity>
    <RaceEthnicityCode>WhiteNonHispanic</RaceEthnicityCode>
  </RaceEthnicity>
</Person>
<AcademicRecord>
  <AcademicSummary>
    <AcademicSummaryType>All</AcademicSummaryType>
    <GPA>
      <GradePointAverage>4.0583</GradePointAverage>
      <GPARangeMinimum>0</GPARangeMinimum>
      <GPARangeMaximum>4.5</GPARangeMaximum>
    </GPA>
    <AcademicHonors>
      <HonorsTitle>Distinguished</HonorsTitle>
      <HonorsLevel>FirstHighest</HonorsLevel>
    </AcademicHonors>
    <ClassRank>19</ClassRank>
    <ClassSize>357</ClassSize>
  </AcademicSummary>
  <AcademicSession>
    <AcademicSessionDetail>
      <SessionDesignator>2001-06</SessionDesignator>
      <SessionName>Summer 2001</SessionName>
      <SessionType>Semester</SessionType>
    </AcademicSessionDetail>
    <StudentLevel>
      <StudentLevelCode>EighthGrade</StudentLevelCode>
    </StudentLevel>
    <Course>
      <CourseCreditBasis>Regular</CourseCreditBasis>
      <CourseCreditUnits>Semester</CourseCreditUnits>
      <CourseCreditValue>1</CourseCreditValue>
      <CourseCreditEarned>1</CourseCreditEarned>
      <CourseAcademicGradeScaleCode>65</CourseAcademicGradeScaleCode>
      <CourseAcademicGrade>90</CourseAcademicGrade>
      <CourseAcademicGradeStatusCode>HonorsGrade</CourseAcademicGradeStatusCode>
      <CourseSubjectAreaCode>Mathematics</CourseSubjectAreaCode>
      <CourseQualityPointsEarned>90</CourseQualityPointsEarned>
      <CourseNumber>013313H</CourseNumber>
      <CourseTitle>ALG1</CourseTitle>
    </Course>
  </AcademicSession>
  <Course>
    <CourseCreditBasis>Regular</CourseCreditBasis>
  </Course>

```

```

    <CourseCreditUnits>Semester</CourseCreditUnits>
    <CourseCreditValue>0.5</CourseCreditValue>
    <CourseCreditEarned>0.5</CourseCreditEarned>
    <CourseAcademicGradeScaleCode>65</CourseAcademicGradeScaleCode>
    <CourseAcademicGrade>95</CourseAcademicGrade>
    <CourseSubjectAreaCode>ForeignLanguageLiterature</CourseSubjectAreaCode>
    <CourseQualityPointsEarned>47.5</CourseQualityPointsEarned>
    <CourseNumber>012313R</CourseNumber>
    <CourseTitle>SPAN1</CourseTitle>
  </Course>

  <Course>
    <CourseCreditBasis>Regular</CourseCreditBasis>
    <CourseCreditUnits>Semester</CourseCreditUnits>
    <CourseCreditValue>0.5</CourseCreditValue>
    <CourseCreditEarned>0.5</CourseCreditEarned>
    <CourseAcademicGradeScaleCode>65</CourseAcademicGradeScaleCode>
    <CourseAcademicGrade>98</CourseAcademicGrade>
    <CourseSubjectAreaCode>ForeignLanguageLiterature</CourseSubjectAreaCode>
    <CourseQualityPointsEarned>49</CourseQualityPointsEarned>
    <CourseNumber>012313R</CourseNumber>
    <CourseTitle>SPAN1</CourseTitle>
  </Course>
</AcademicSession>

<AcademicSession>
  <AcademicSessionDetail>
    <SessionDesignator>2001-09</SessionDesignator>
    <SessionName>Fall2001</SessionName>
    <SessionType>Semester</SessionType>
  </AcademicSessionDetail>
  <StudentLevel>
    <StudentLevelCode>NinthGrade</StudentLevelCode>
  </StudentLevel>
  <Course>
    <CourseCreditBasis>Regular</CourseCreditBasis>
    <CourseCreditUnits>Semester</CourseCreditUnits>
    <CourseCreditValue>0.5</CourseCreditValue>
    <CourseCreditEarned>0.5</CourseCreditEarned>
    <CourseAcademicGradeScaleCode>65</CourseAcademicGradeScaleCode>
    <CourseAcademicGrade>92</CourseAcademicGrade>
    <CourseAcademicGradeStatusCode>HonorsGrade</CourseAcademicGradeStatusCode>
    <CourseSubjectAreaCode>EnglishLanguageLiterature</CourseSubjectAreaCode>
    <CourseQualityPointsEarned>46</CourseQualityPointsEarned>
    <CourseNumber>011013H</CourseNumber>
    <CourseTitle>ENG1</CourseTitle>
  </Course>

  <Course>
    <CourseCreditBasis>Regular</CourseCreditBasis>
    <CourseCreditUnits>Semester</CourseCreditUnits>
    <CourseCreditValue>0.5</CourseCreditValue>
    <CourseCreditEarned>0.5</CourseCreditEarned>
    <CourseAcademicGradeScaleCode>65</CourseAcademicGradeScaleCode>
    <CourseAcademicGrade>86</CourseAcademicGrade>
    <CourseAcademicGradeStatusCode>HonorsGrade</CourseAcademicGradeStatusCode>
    <CourseSubjectAreaCode>Mathematics</CourseSubjectAreaCode>
    <CourseQualityPointsEarned>43</CourseQualityPointsEarned>
    <CourseNumber>013413H</CourseNumber>
    <CourseTitle>GEOM</CourseTitle>
  </Course>

  <Course>
    <CourseCreditBasis>Regular</CourseCreditBasis>
    <CourseCreditUnits>Semester</CourseCreditUnits>
    <CourseCreditValue>0.5</CourseCreditValue>
    <CourseCreditEarned>0.5</CourseCreditEarned>
    <CourseAcademicGradeScaleCode>65</CourseAcademicGradeScaleCode>
    <CourseAcademicGrade>91</CourseAcademicGrade>
    <CourseAcademicGradeStatusCode>HonorsGrade</CourseAcademicGradeStatusCode>

```

```

    <CourseSubjectAreaCode>LifePhysicalSciences</CourseSubjectAreaCode>
    <CourseQualityPointsEarned>45.5</CourseQualityPointsEarned>
    <CourseNumber>014123H</CourseNumber>
    <CourseTitle>BIO</CourseTitle>
    <NoteMessage>6Science</NoteMessage>
  </Course>

  <Course>
    <CourseCreditBasis>Regular</CourseCreditBasis>
    <CourseCreditUnits>Semester</CourseCreditUnits>
    <CourseCreditValue>0.5</CourseCreditValue>
    <CourseCreditEarned>0.5</CourseCreditEarned>
    <CourseAcademicGradeScaleCode>65</CourseAcademicGradeScaleCode>
    <CourseAcademicGrade>93</CourseAcademicGrade>
    <CourseAcademicGradeStatusCode>HonorsGrade</CourseAcademicGradeStatusCode>
    <CourseSubjectAreaCode>SocialSciencesHistory</CourseSubjectAreaCode>
    <CourseQualityPointsEarned>46.5</CourseQualityPointsEarned>
    <CourseNumber>014513H</CourseNumber>
    <CourseTitle>WGEO</CourseTitle>
  </Course>

  <Course>
    <CourseCreditBasis>Regular</CourseCreditBasis>
    <CourseCreditUnits>Semester</CourseCreditUnits>
    <CourseCreditValue>0.5</CourseCreditValue>
    <CourseCreditEarned>0.5</CourseCreditEarned>
    <CourseAcademicGradeScaleCode>65</CourseAcademicGradeScaleCode>
    <CourseAcademicGrade>97</CourseAcademicGrade>
    <CourseSubjectAreaCode>PhysicalHealthSafetyEducation</CourseSubjectAreaCode>
    <CourseQualityPointsEarned>48.5</CourseQualityPointsEarned>
    <CourseNumber>016931R</CourseNumber>
    <CourseTitle>HLTHED</CourseTitle>
  </Course>

  <Course>
    <CourseCreditBasis>Regular</CourseCreditBasis>
    <CourseCreditUnits>Semester</CourseCreditUnits>
    <CourseCreditValue>0.5</CourseCreditValue>
    <CourseCreditEarned>0.5</CourseCreditEarned>
    <CourseAcademicGradeScaleCode>65</CourseAcademicGradeScaleCode>
    <CourseAcademicGrade>100</CourseAcademicGrade>
    <CourseSubjectAreaCode>ForeignLanguageLiterature</CourseSubjectAreaCode>
    <CourseQualityPointsEarned>50</CourseQualityPointsEarned>
    <CourseNumber>012323R</CourseNumber>
    <CourseTitle>SPAN2</CourseTitle>
  </Course>

  <Course>
    <CourseCreditBasis>Regular</CourseCreditBasis>
    <CourseCreditUnits>Semester</CourseCreditUnits>
    <CourseCreditValue>0.5</CourseCreditValue>
    <CourseCreditEarned>0.5</CourseCreditEarned>
    <CourseAcademicGradeScaleCode>65</CourseAcademicGradeScaleCode>
    <CourseAcademicGrade>92</CourseAcademicGrade>
    <CourseSubjectAreaCode>FinePerformingArts</CourseSubjectAreaCode>
    <CourseQualityPointsEarned>46</CourseQualityPointsEarned>
    <CourseNumber>011643R</CourseNumber>
    <CourseTitle>TH1</CourseTitle>
  </Course>
</AcademicSession>

<AcademicSession>
  <AcademicSessionDetail>
    <SessionDesignator>2002-01</SessionDesignator>
    <SessionName>Spring 2002</SessionName>
    <SessionType>Semester</SessionType>
  </AcademicSessionDetail>
  <StudentLevel>
    <StudentLevelCode>NinthGrade</StudentLevelCode>
  </StudentLevel>

```

```
<Course>
  <CourseCreditBasis>Regular</CourseCreditBasis>
  <CourseCreditUnits>Semester</CourseCreditUnits>
  <CourseCreditValue>0.5</CourseCreditValue>
  <CourseCreditEarned>0.5</CourseCreditEarned>
  <CourseAcademicGradeScaleCode>65</CourseAcademicGradeScaleCode>
  <CourseAcademicGrade>93</CourseAcademicGrade>
  <CourseAcademicGradeStatusCode>HonorsGrade</CourseAcademicGradeStatusCode>
  <CourseSubjectAreaCode>EnglishLanguageLiterature</CourseSubjectAreaCode>
  <CourseQualityPointsEarned>46.5</CourseQualityPointsEarned>
  <CourseNumber>011013H</CourseNumber>
  <CourseTitle>ENG1</CourseTitle>
</Course>

<Course>
  <CourseCreditBasis>Regular</CourseCreditBasis>
  <CourseCreditUnits>Semester</CourseCreditUnits>
  <CourseCreditValue>0.5</CourseCreditValue>
  <CourseCreditEarned>0.5</CourseCreditEarned>
  <CourseAcademicGradeScaleCode>65</CourseAcademicGradeScaleCode>
  <CourseAcademicGrade>79</CourseAcademicGrade>
  <CourseAcademicGradeStatusCode>HonorsGrade</CourseAcademicGradeStatusCode>
  <CourseSubjectAreaCode>Mathematics</CourseSubjectAreaCode>
  <CourseQualityPointsEarned>39.5</CourseQualityPointsEarned>
  <CourseNumber>013413H</CourseNumber>
  <CourseTitle>GEOM</CourseTitle>
</Course>

<Course>
  <CourseCreditBasis>Regular</CourseCreditBasis>
  <CourseCreditUnits>Semester</CourseCreditUnits>
  <CourseCreditValue>0.5</CourseCreditValue>
  <CourseCreditEarned>0.5</CourseCreditEarned>
  <CourseAcademicGradeScaleCode>65</CourseAcademicGradeScaleCode>
  <CourseAcademicGrade>92</CourseAcademicGrade>
  <CourseAcademicGradeStatusCode>HonorsGrade</CourseAcademicGradeStatusCode>
  <CourseSubjectAreaCode>LifePhysicalSciences</CourseSubjectAreaCode>
  <CourseQualityPointsEarned>46</CourseQualityPointsEarned>
  <CourseNumber>014123H</CourseNumber>
  <CourseTitle>BIO</CourseTitle>
</Course>

<Course>
  <CourseCreditBasis>Regular</CourseCreditBasis>
  <CourseCreditUnits>Semester</CourseCreditUnits>
  <CourseCreditValue>0.5</CourseCreditValue>
  <CourseCreditEarned>0.5</CourseCreditEarned>
  <CourseAcademicGradeScaleCode>65</CourseAcademicGradeScaleCode>
  <CourseAcademicGrade>98</CourseAcademicGrade>
  <CourseAcademicGradeStatusCode>HonorsGrade</CourseAcademicGradeStatusCode>
  <CourseSubjectAreaCode>SocialSciencesHistory</CourseSubjectAreaCode>
  <CourseQualityPointsEarned>49</CourseQualityPointsEarned>
  <CourseNumber>014513H</CourseNumber>
  <CourseTitle>WGEO</CourseTitle>
</Course>

<Course>
  <CourseCreditBasis>Regular</CourseCreditBasis>
  <CourseCreditUnits>Semester</CourseCreditUnits>
  <CourseCreditValue>0.5</CourseCreditValue>
  <CourseCreditEarned>0.5</CourseCreditEarned>
  <CourseAcademicGradeScaleCode>65</CourseAcademicGradeScaleCode>
  <CourseAcademicGrade>100</CourseAcademicGrade>
  <CourseSubjectAreaCode>PhysicalHealthSafetyEducation</CourseSubjectAreaCode>
  <CourseQualityPointsEarned>50</CourseQualityPointsEarned>
  <CourseNumber>016919R</CourseNumber>
  <CourseTitle>PEEQ1</CourseTitle>
</Course>

<Course>
```

```

    <CourseCreditBasis>Regular</CourseCreditBasis>
    <CourseCreditUnits>Semester</CourseCreditUnits>
    <CourseCreditValue>0.5</CourseCreditValue>
    <CourseCreditEarned>0.5</CourseCreditEarned>
    <CourseAcademicGradeScaleCode>65</CourseAcademicGradeScaleCode>
    <CourseAcademicGrade>99</CourseAcademicGrade>
    <CourseSubjectAreaCode>ForeignLanguageLiterature</CourseSubjectAreaCode>
    <CourseQualityPointsEarned>49.5</CourseQualityPointsEarned>
    <CourseNumber>012323R</CourseNumber>
    <CourseTitle>SPAN2</CourseTitle>
  </Course>

  <Course>
    <CourseCreditBasis>Regular</CourseCreditBasis>
    <CourseCreditUnits>Semester</CourseCreditUnits>
    <CourseCreditValue>0.5</CourseCreditValue>
    <CourseCreditEarned>0.5</CourseCreditEarned>
    <CourseAcademicGradeScaleCode>65</CourseAcademicGradeScaleCode>
    <CourseAcademicGrade>90</CourseAcademicGrade>
    <CourseSubjectAreaCode>FinePerformingArts</CourseSubjectAreaCode>
    <CourseQualityPointsEarned>45</CourseQualityPointsEarned>
    <CourseNumber>011643R</CourseNumber>
    <CourseTitle>TH1</CourseTitle>
  </Course>
</AcademicSession>

<AcademicSession>
  <AcademicSessionDetail>
    <SessionDesignator>2002-09</SessionDesignator>
    <SessionName>Fall2002</SessionName>
    <SessionType>Semester</SessionType>
  </AcademicSessionDetail>
  <StudentLevel>
    <StudentLevelCode>TenthGrade</StudentLevelCode>
  </StudentLevel>
  <Course>
    <CourseCreditBasis>Regular</CourseCreditBasis>
    <CourseCreditUnits>Semester</CourseCreditUnits>
    <CourseCreditValue>0.5</CourseCreditValue>
    <CourseCreditEarned>0.5</CourseCreditEarned>
    <CourseAcademicGradeScaleCode>65</CourseAcademicGradeScaleCode>
    <CourseAcademicGrade>93</CourseAcademicGrade>
    <CourseAcademicGradeStatusCode>HonorsGrade</CourseAcademicGradeStatusCode>
    <CourseSubjectAreaCode>EnglishLanguageLiterature</CourseSubjectAreaCode>
    <CourseQualityPointsEarned>46.5</CourseQualityPointsEarned>
    <CourseNumber>011023H</CourseNumber>
    <CourseTitle>ENG2</CourseTitle>
  </Course>

  <Course>
    <CourseCreditBasis>Regular</CourseCreditBasis>
    <CourseCreditUnits>Semester</CourseCreditUnits>
    <CourseCreditValue>0.5</CourseCreditValue>
    <CourseCreditEarned>0.5</CourseCreditEarned>
    <CourseAcademicGradeScaleCode>65</CourseAcademicGradeScaleCode>
    <CourseAcademicGrade>85</CourseAcademicGrade>
    <CourseAcademicGradeStatusCode>HonorsGrade</CourseAcademicGradeStatusCode>
    <CourseSubjectAreaCode>Mathematics</CourseSubjectAreaCode>
    <CourseQualityPointsEarned>42.5</CourseQualityPointsEarned>
    <CourseNumber>013323H</CourseNumber>
    <CourseTitle>ALG2</CourseTitle>
  </Course>

  <Course>
    <CourseCreditBasis>Regular</CourseCreditBasis>
    <CourseCreditUnits>Semester</CourseCreditUnits>
    <CourseCreditValue>0.5</CourseCreditValue>
    <CourseCreditEarned>0.5</CourseCreditEarned>
    <CourseAcademicGradeScaleCode>65</CourseAcademicGradeScaleCode>
    <CourseAcademicGrade>92</CourseAcademicGrade>

```

```

    <CourseAcademicGradeStatusCode>HonorsGrade</CourseAcademicGradeStatusCode>
    <CourseSubjectAreaCode>LifePhysicalSciences</CourseSubjectAreaCode>
    <CourseQualityPointsEarned>46</CourseQualityPointsEarned>
    <CourseNumber>014323H</CourseNumber>
    <CourseTitle>CHEM</CourseTitle>
  </Course>

  <Course>
    <CourseCreditBasis>Regular</CourseCreditBasis>
    <CourseCreditUnits>Semester</CourseCreditUnits>
    <CourseCreditValue>0.5</CourseCreditValue>
    <CourseCreditEarned>0.5</CourseCreditEarned>
    <CourseAcademicGradeScaleCode>65</CourseAcademicGradeScaleCode>
    <CourseAcademicGrade>96</CourseAcademicGrade>
    <CourseAcademicGradeStatusCode>HonorsGrade</CourseAcademicGradeStatusCode>
    <CourseSubjectAreaCode>SocialSciencesHistory</CourseSubjectAreaCode>
    <CourseQualityPointsEarned>48</CourseQualityPointsEarned>
    <CourseNumber>014623H</CourseNumber>
    <CourseTitle>WHIST</CourseTitle>
  </Course>

  <Course>
    <CourseCreditBasis>Regular</CourseCreditBasis>
    <CourseCreditUnits>Semester</CourseCreditUnits>
    <CourseCreditValue>0.5</CourseCreditValue>
    <CourseCreditEarned>0.5</CourseCreditEarned>
    <CourseAcademicGradeScaleCode>65</CourseAcademicGradeScaleCode>
    <CourseAcademicGrade>100</CourseAcademicGrade>
    <CourseSubjectAreaCode>PhysicalHealthSafetyEducation</CourseSubjectAreaCode>
    <CourseQualityPointsEarned>50</CourseQualityPointsEarned>
    <CourseNumber>26919R1</CourseNumber>
    <CourseTitle>PEEQ3</CourseTitle>
  </Course>

  <Course>
    <CourseCreditBasis>Regular</CourseCreditBasis>
    <CourseCreditUnits>Semester</CourseCreditUnits>
    <CourseCreditValue>0.5</CourseCreditValue>
    <CourseCreditEarned>0.5</CourseCreditEarned>
    <CourseAcademicGradeScaleCode>65</CourseAcademicGradeScaleCode>
    <CourseAcademicGrade>94</CourseAcademicGrade>
    <CourseAcademicGradeStatusCode>HonorsGrade</CourseAcademicGradeStatusCode>
    <CourseSubjectAreaCode>ForeignLanguageLiterature</CourseSubjectAreaCode>
    <CourseQualityPointsEarned>47</CourseQualityPointsEarned>
    <CourseNumber>012333H</CourseNumber>
    <CourseTitle>SPAN3</CourseTitle>
  </Course>

  <Course>
    <CourseCreditBasis>HighSchoolDualCredit</CourseCreditBasis>
    <CourseCreditUnits>Semester</CourseCreditUnits>
    <CourseCreditValue>0.5</CourseCreditValue>
    <CourseCreditEarned>0.5</CourseCreditEarned>
    <CourseAcademicGradeScaleCode>65</CourseAcademicGradeScaleCode>
    <CourseAcademicGrade>98</CourseAcademicGrade>
    <CourseSubjectAreaCode>EngineeringTechnology</CourseSubjectAreaCode>
    <CourseQualityPointsEarned>49</CourseQualityPointsEarned>
    <CourseNumber>28193$0</CourseNumber>
    <CourseTitle>BEGBCIS1</CourseTitle>
  </Course>
</AcademicSession>

<AcademicSession>
  <AcademicSessionDetail>
    <SessionDesignator>2003-01</SessionDesignator>
    <SessionName>Spring 2003</SessionName>
    <SessionType>Semester</SessionType>
  </AcademicSessionDetail>
  <StudentLevel>
    <StudentLevelCode>TenthGrade</StudentLevelCode>
  </StudentLevel>

```



```

</StudentLevel>
<Course>
  <CourseCreditBasis>Regular</CourseCreditBasis>
  <CourseCreditUnits>Semester</CourseCreditUnits>
  <CourseCreditValue>0.5</CourseCreditValue>
  <CourseCreditEarned>0.5</CourseCreditEarned>
  <CourseAcademicGradeScaleCode>65</CourseAcademicGradeScaleCode>
  <CourseAcademicGrade>96</CourseAcademicGrade>
  <CourseAcademicGradeStatusCode>HonorsGrade</CourseAcademicGradeStatusCode>
  <CourseSubjectAreaCode>EnglishLanguageLiterature</CourseSubjectAreaCode>
  <CourseQualityPointsEarned>48</CourseQualityPointsEarned>
  <CourseNumber>011023H</CourseNumber>
  <CourseTitle>ENG2</CourseTitle>
</Course>

<Course>
  <CourseCreditBasis>Regular</CourseCreditBasis>
  <CourseCreditUnits>Semester</CourseCreditUnits>
  <CourseCreditValue>0.5</CourseCreditValue>
  <CourseCreditEarned>0.5</CourseCreditEarned>
  <CourseAcademicGradeScaleCode>65</CourseAcademicGradeScaleCode>
  <CourseAcademicGrade>83</CourseAcademicGrade>
  <CourseAcademicGradeStatusCode>HonorsGrade</CourseAcademicGradeStatusCode>
  <CourseSubjectAreaCode>Mathematics</CourseSubjectAreaCode>
  <CourseQualityPointsEarned>41.5</CourseQualityPointsEarned>
  <CourseNumber>013323H</CourseNumber>
  <CourseTitle>ALG2</CourseTitle>
</Course>

<Course>
  <CourseCreditBasis>Regular</CourseCreditBasis>
  <CourseCreditUnits>Semester</CourseCreditUnits>
  <CourseCreditValue>0.5</CourseCreditValue>
  <CourseCreditEarned>0.5</CourseCreditEarned>
  <CourseAcademicGradeScaleCode>65</CourseAcademicGradeScaleCode>
  <CourseAcademicGrade>91</CourseAcademicGrade>
  <CourseAcademicGradeStatusCode>HonorsGrade</CourseAcademicGradeStatusCode>
  <CourseSubjectAreaCode>LifePhysicalSciences</CourseSubjectAreaCode>
  <CourseQualityPointsEarned>45.5</CourseQualityPointsEarned>
  <CourseNumber>014323H</CourseNumber>
  <CourseTitle>CHEM</CourseTitle>
</Course>

<Course>
  <CourseCreditBasis>Regular</CourseCreditBasis>
  <CourseCreditUnits>Semester</CourseCreditUnits>
  <CourseCreditValue>0.5</CourseCreditValue>
  <CourseCreditEarned>0.5</CourseCreditEarned>
  <CourseAcademicGradeScaleCode>65</CourseAcademicGradeScaleCode>
  <CourseAcademicGrade>97</CourseAcademicGrade>
  <CourseAcademicGradeStatusCode>HonorsGrade</CourseAcademicGradeStatusCode>
  <CourseSubjectAreaCode>SocialSciencesHistory</CourseSubjectAreaCode>
  <CourseQualityPointsEarned>48.5</CourseQualityPointsEarned>
  <CourseNumber>014623H</CourseNumber>
  <CourseTitle>WHIST</CourseTitle>
</Course>

<Course>
  <CourseCreditBasis>Regular</CourseCreditBasis>
  <CourseCreditUnits>Semester</CourseCreditUnits>
  <CourseCreditValue>0.5</CourseCreditValue>
  <CourseCreditEarned>0.5</CourseCreditEarned>
  <CourseAcademicGradeScaleCode>65</CourseAcademicGradeScaleCode>
  <CourseAcademicGrade>100</CourseAcademicGrade>
  <CourseSubjectAreaCode>PhysicalHealthSafetyEducation</CourseSubjectAreaCode>
  <CourseQualityPointsEarned>50</CourseQualityPointsEarned>
  <CourseNumber>26919R1</CourseNumber>
  <CourseTitle>PEEQ3</CourseTitle>
  <NoteMessage>7P.E./Equivalent</NoteMessage>
</Course>

```

```

<Course>
  <CourseCreditBasis>Regular</CourseCreditBasis>
  <CourseCreditUnits>Semester</CourseCreditUnits>
  <CourseCreditValue>0.5</CourseCreditValue>
  <CourseCreditEarned>0.5</CourseCreditEarned>
  <CourseAcademicGradeScaleCode>65</CourseAcademicGradeScaleCode>
  <CourseAcademicGrade>94</CourseAcademicGrade>
  <CourseAcademicGradeStatusCode>HonorsGrade</CourseAcademicGradeStatusCode>
  <CourseSubjectAreaCode>ForeignLanguageLiterature</CourseSubjectAreaCode>
  <CourseQualityPointsEarned>47</CourseQualityPointsEarned>
  <CourseNumber>012333H</CourseNumber>
  <CourseTitle>SPAN3</CourseTitle>
</Course>

<Course>
  <CourseCreditBasis>HighSchoolDualCredit</CourseCreditBasis>
  <CourseCreditUnits>Semester</CourseCreditUnits>
  <CourseCreditValue>0.5</CourseCreditValue>
  <CourseCreditEarned>0.5</CourseCreditEarned>
  <CourseAcademicGradeScaleCode>65</CourseAcademicGradeScaleCode>
  <CourseAcademicGrade>96</CourseAcademicGrade>
  <CourseSubjectAreaCode>EngineeringTechnology</CourseSubjectAreaCode>
  <CourseQualityPointsEarned>48</CourseQualityPointsEarned>
  <CourseNumber>28193$0</CourseNumber>
  <CourseTitle>BEGBCIS1</CourseTitle>
</Course>
</AcademicSession>
<AcademicSession>
  <AcademicSessionDetail>
    <SessionDesignator>2003-09</SessionDesignator>
    <SessionName>Fall2003</SessionName>
    <SessionType>Semester</SessionType>
  </AcademicSessionDetail>
  <StudentLevel>
    <StudentLevelCode>EleventhGrade</StudentLevelCode>
  </StudentLevel>
  <Course>
    <CourseCreditBasis>AdvancedPlacement</CourseCreditBasis>
    <CourseCreditUnits>Semester</CourseCreditUnits>
    <CourseCreditValue>0.5</CourseCreditValue>
    <CourseCreditEarned>0.5</CourseCreditEarned>
    <CourseAcademicGradeScaleCode>65</CourseAcademicGradeScaleCode>
    <CourseAcademicGrade>93</CourseAcademicGrade>
    <CourseSubjectAreaCode>EnglishLanguageLiterature</CourseSubjectAreaCode>
    <CourseQualityPointsEarned>46.5</CourseQualityPointsEarned>
    <CourseNumber>011054P</CourseNumber>
    <CourseTitle>APENGLAN</CourseTitle>
  </Course>

  <Course>
    <CourseCreditBasis>Regular</CourseCreditBasis>
    <CourseCreditUnits>Semester</CourseCreditUnits>
    <CourseCreditValue>0.5</CourseCreditValue>
    <CourseCreditEarned>0.5</CourseCreditEarned>
    <CourseAcademicGradeScaleCode>65</CourseAcademicGradeScaleCode>
    <CourseAcademicGrade>88</CourseAcademicGrade>
    <CourseAcademicGradeStatusCode>HonorsGrade</CourseAcademicGradeStatusCode>
    <CourseSubjectAreaCode>Mathematics</CourseSubjectAreaCode>
    <CourseQualityPointsEarned>44</CourseQualityPointsEarned>
    <CourseNumber>013633H</CourseNumber>
    <CourseTitle>PRECALC</CourseTitle>
  </Course>

  <Course>
    <CourseCreditBasis>Regular</CourseCreditBasis>
    <CourseCreditUnits>Semester</CourseCreditUnits>
    <CourseCreditValue>0.5</CourseCreditValue>
    <CourseCreditEarned>0.5</CourseCreditEarned>

```

```

    <CourseAcademicGradeScaleCode>65</CourseAcademicGradeScaleCode>
    <CourseAcademicGrade>90</CourseAcademicGrade>
    <CourseAcademicGradeStatusCode>HonorsGrade</CourseAcademicGradeStatusCode>
    <CourseSubjectAreaCode>LifePhysicalSciences</CourseSubjectAreaCode>
    <CourseQualityPointsEarned>45</CourseQualityPointsEarned>
    <CourseNumber>014424H</CourseNumber>
    <CourseTitle>PHYSICS</CourseTitle>
  </Course>

  <Course>
    <CourseCreditBasis>AdvancedPlacement</CourseCreditBasis>
    <CourseCreditUnits>Semester</CourseCreditUnits>
    <CourseCreditValue>0.5</CourseCreditValue>
    <CourseCreditEarned>0.5</CourseCreditEarned>
    <CourseAcademicGradeScaleCode>65</CourseAcademicGradeScaleCode>
    <CourseAcademicGrade>98</CourseAcademicGrade>
    <CourseSubjectAreaCode>SocialSciencesHistory</CourseSubjectAreaCode>
    <CourseQualityPointsEarned>49</CourseQualityPointsEarned>
    <CourseNumber>014735P</CourseNumber>
    <CourseTitle>APUSHIST</CourseTitle>
  </Course>

  <Course>
    <CourseCreditBasis>AdvancedPlacement</CourseCreditBasis>
    <CourseCreditUnits>Semester</CourseCreditUnits>
    <CourseCreditValue>0.5</CourseCreditValue>
    <CourseCreditEarned>0.5</CourseCreditEarned>
    <CourseAcademicGradeScaleCode>65</CourseAcademicGradeScaleCode>
    <CourseAcademicGrade>97</CourseAcademicGrade>
    <CourseSubjectAreaCode>ForeignLanguageLiterature</CourseSubjectAreaCode>
    <CourseQualityPointsEarned>48.5</CourseQualityPointsEarned>
    <CourseNumber>012394P</CourseNumber>
    <CourseTitle>APSPALAN</CourseTitle>
  </Course>

  <Course>
    <CourseCreditBasis>Regular</CourseCreditBasis>
    <CourseCreditUnits>Semester</CourseCreditUnits>
    <CourseCreditValue>0.5</CourseCreditValue>
    <CourseCreditEarned>0.5</CourseCreditEarned>
    <CourseAcademicGradeScaleCode>65</CourseAcademicGradeScaleCode>
    <CourseAcademicGrade>P</CourseAcademicGrade>
    <CourseSubjectAreaCode>Miscellaneous</CourseSubjectAreaCode>
    <CourseQualityPointsEarned>0</CourseQualityPointsEarned>
    <CourseNumber>011448F</CourseNumber>
    <CourseTitle>INDENG</CourseTitle>
    <NoteMessage>9OtherElectives</NoteMessage>
  </Course>

  <Course>
    <CourseCreditBasis>AdvancedPlacement</CourseCreditBasis>
    <CourseCreditUnits>Semester</CourseCreditUnits>
    <CourseCreditValue>0.5</CourseCreditValue>
    <CourseCreditEarned>0.5</CourseCreditEarned>
    <CourseAcademicGradeScaleCode>65</CourseAcademicGradeScaleCode>
    <CourseAcademicGrade>99</CourseAcademicGrade>
    <CourseSubjectAreaCode>HumanServices</CourseSubjectAreaCode>
    <CourseQualityPointsEarned>49.5</CourseQualityPointsEarned>
    <CourseNumber>014940P</CourseNumber>
    <CourseTitle>APPSYCH</CourseTitle>
    <NoteMessage>9OtherElectives</NoteMessage>
  </Course>
</AcademicSession>

<AcademicSession>
  <AcademicSessionDetail>
    <SessionDesignator>2004-01</SessionDesignator>
    <SessionName>Spring2004</SessionName>
    <SessionType>Semester</SessionType>
  </AcademicSessionDetail>

```

```

<StudentLevel>
  <StudentLevelCode>EleventhGrade</StudentLevelCode>
</StudentLevel>
<Course>
  <CourseCreditBasis>AdvancedPlacement</CourseCreditBasis>
  <CourseCreditUnits>Semester</CourseCreditUnits>
  <CourseCreditValue>0.5</CourseCreditValue>
  <CourseCreditEarned>0.5</CourseCreditEarned>
  <CourseAcademicGradeScaleCode>65</CourseAcademicGradeScaleCode>
  <CourseAcademicGrade>95</CourseAcademicGrade>
  <CourseSubjectAreaCode>EnglishLanguageLiterature</CourseSubjectAreaCode>
  <CourseQualityPointsEarned>47.5</CourseQualityPointsEarned>
  <CourseNumber>011054P</CourseNumber>
  <CourseTitle>APENGLAN</CourseTitle>
</Course>

<Course>
  <CourseCreditBasis>Regular</CourseCreditBasis>
  <CourseCreditUnits>Semester</CourseCreditUnits>
  <CourseCreditValue>0.5</CourseCreditValue>
  <CourseCreditEarned>0.5</CourseCreditEarned>
  <CourseAcademicGradeScaleCode>65</CourseAcademicGradeScaleCode>
  <CourseAcademicGrade>83</CourseAcademicGrade>
  <CourseAcademicGradeStatusCode>HonorsGrade</CourseAcademicGradeStatusCode>
  <CourseSubjectAreaCode>Mathematics</CourseSubjectAreaCode>
  <CourseQualityPointsEarned>41.5</CourseQualityPointsEarned>
  <CourseNumber>013633H</CourseNumber>
  <CourseTitle>PRECALC</CourseTitle>
</Course>

<Course>
  <CourseCreditBasis>Regular</CourseCreditBasis>
  <CourseCreditUnits>Semester</CourseCreditUnits>
  <CourseCreditValue>0.5</CourseCreditValue>
  <CourseCreditEarned>0.5</CourseCreditEarned>
  <CourseAcademicGradeScaleCode>65</CourseAcademicGradeScaleCode>
  <CourseAcademicGrade>95</CourseAcademicGrade>
  <CourseAcademicGradeStatusCode>HonorsGrade</CourseAcademicGradeStatusCode>
  <CourseSubjectAreaCode>LifePhysicalSciences</CourseSubjectAreaCode>
  <CourseQualityPointsEarned>47.5</CourseQualityPointsEarned>
  <CourseNumber>014424H</CourseNumber>
  <CourseTitle>PHYSICS</CourseTitle>
</Course>

<Course>
  <CourseCreditBasis>AdvancedPlacement</CourseCreditBasis>
  <CourseCreditUnits>Semester</CourseCreditUnits>
  <CourseCreditValue>0.5</CourseCreditValue>
  <CourseCreditEarned>0.5</CourseCreditEarned>
  <CourseAcademicGradeScaleCode>65</CourseAcademicGradeScaleCode>
  <CourseAcademicGrade>98</CourseAcademicGrade>
  <CourseSubjectAreaCode>SocialSciencesHistory</CourseSubjectAreaCode>
  <CourseQualityPointsEarned>49</CourseQualityPointsEarned>
  <CourseNumber>014735P</CourseNumber>
  <CourseTitle>APUSHIST</CourseTitle>
</Course>

<Course>
  <CourseCreditBasis>AdvancedPlacement</CourseCreditBasis>
  <CourseCreditUnits>Semester</CourseCreditUnits>
  <CourseCreditValue>0.5</CourseCreditValue>
  <CourseCreditEarned>0.5</CourseCreditEarned>
  <CourseAcademicGradeScaleCode>65</CourseAcademicGradeScaleCode>
  <CourseAcademicGrade>98</CourseAcademicGrade>
  <CourseSubjectAreaCode>ForeignLanguageLiterature</CourseSubjectAreaCode>
  <CourseQualityPointsEarned>49</CourseQualityPointsEarned>
  <CourseNumber>012394P</CourseNumber>
  <CourseTitle>APSPALAN</CourseTitle>
</Course>

```

```

    <Course>
      <CourseCreditBasis>Regular</CourseCreditBasis>
      <CourseCreditUnits>Semester</CourseCreditUnits>
      <CourseCreditValue>0.5</CourseCreditValue>
      <CourseCreditEarned>0.5</CourseCreditEarned>
      <CourseAcademicGradeScaleCode>65</CourseAcademicGradeScaleCode>
      <CourseAcademicGrade>P</CourseAcademicGrade>
      <CourseSubjectAreaCode>SocialSciencesHistory</CourseSubjectAreaCode>
      <CourseQualityPointsEarned>0</CourseQualityPointsEarned>
      <CourseNumber>014931F</CourseNumber>
      <CourseTitle>SOC</CourseTitle>
      <NoteMessage>9OtherElectives</NoteMessage>
    </Course>

    <Course>
      <CourseCreditBasis>Regular</CourseCreditBasis>
      <CourseCreditUnits>Semester</CourseCreditUnits>
      <CourseCreditValue>0.5</CourseCreditValue>
      <CourseCreditEarned>0.5</CourseCreditEarned>
      <CourseAcademicGradeScaleCode>65</CourseAcademicGradeScaleCode>
      <CourseAcademicGrade>96</CourseAcademicGrade>
      <CourseSubjectAreaCode>Miscellaneous</CourseSubjectAreaCode>
      <CourseQualityPointsEarned>48</CourseQualityPointsEarned>
      <CourseNumber>24932R2</CourseNumber>
      <CourseTitle>SPTSS</CourseTitle>
      <NoteMessage>9OtherElectives</NoteMessage>
    </Course>
  </AcademicSession>

  <AcademicSession>
    <AcademicSessionDetail>
      <SessionDesignator>2004-09</SessionDesignator>
      <SessionName>Fall2004</SessionName>
      <SessionType>Semester</SessionType>
    </AcademicSessionDetail>
    <StudentLevel>
      <StudentLevelCode>TwelfthGrade</StudentLevelCode>
    </StudentLevel>
    <Course>
      <CourseCreditBasis>AdvancedPlacement</CourseCreditBasis>
      <CourseCreditUnits>Semester</CourseCreditUnits>
      <CourseCreditValue>0.5</CourseCreditValue>
      <CourseCreditEarned>0.5</CourseCreditEarned>
      <CourseAcademicGradeScaleCode>65</CourseAcademicGradeScaleCode>
      <CourseAcademicGrade>91</CourseAcademicGrade>
      <CourseSubjectAreaCode>EnglishLanguageLiterature</CourseSubjectAreaCode>
      <CourseQualityPointsEarned>45.5</CourseQualityPointsEarned>
      <CourseNumber>1043.P000.A</CourseNumber>
      <CourseTitle>APENGLIT</CourseTitle>
    </Course>

    <Course>
      <CourseCreditBasis>Regular</CourseCreditBasis>
      <CourseCreditUnits>Semester</CourseCreditUnits>
      <CourseCreditValue>0.5</CourseCreditValue>
      <CourseCreditEarned>0.5</CourseCreditEarned>
      <CourseAcademicGradeScaleCode>65</CourseAcademicGradeScaleCode>
      <CourseAcademicGrade>95</CourseAcademicGrade>
      <CourseSubjectAreaCode>EnglishLanguageLiterature</CourseSubjectAreaCode>
      <CourseQualityPointsEarned>47.5</CourseQualityPointsEarned>
      <CourseNumber>1525.R000.X</CourseNumber>
      <CourseTitle>COMMAPP</CourseTitle>
      <NoteMessage>FSpeech</NoteMessage>
    </Course>

    <Course>
      <CourseCreditBasis>AdvancedPlacement</CourseCreditBasis>
      <CourseCreditUnits>Semester</CourseCreditUnits>
      <CourseCreditValue>0.5</CourseCreditValue>
      <CourseCreditEarned>0.5</CourseCreditEarned>
  
```

```

        <CourseAcademicGradeScaleCode>65</CourseAcademicGradeScaleCode>
        <CourseAcademicGrade>86</CourseAcademicGrade>
        <CourseSubjectAreaCode>Mathematics</CourseSubjectAreaCode>
        <CourseQualityPointsEarned>43</CourseQualityPointsEarned>
        <CourseNumber>3616.P000.A</CourseNumber>
        <CourseTitle>APCALCBC</CourseTitle>
    </Course>

    <Course>
        <CourseCreditBasis>Regular</CourseCreditBasis>
        <CourseCreditUnits>Semester</CourseCreditUnits>
        <CourseCreditValue>0.5</CourseCreditValue>
        <CourseCreditEarned>0.5</CourseCreditEarned>
        <CourseAcademicGradeScaleCode>65</CourseAcademicGradeScaleCode>
        <CourseAcademicGrade>96</CourseAcademicGrade>
        <CourseAcademicGradeStatusCode>HonorsGrade</CourseAcademicGradeStatusCode>
        <CourseSubjectAreaCode>LifePhysicalSciences</CourseSubjectAreaCode>
        <CourseQualityPointsEarned>48</CourseQualityPointsEarned>
        <CourseNumber>4135.H000.A</CourseNumber>
        <CourseTitle>ANAT\PHY</CourseTitle>
    </Course>

    <Course>
        <CourseCreditBasis>AdvancedPlacement</CourseCreditBasis>
        <CourseCreditUnits>Semester</CourseCreditUnits>
        <CourseCreditValue>0.5</CourseCreditValue>
        <CourseCreditEarned>0.5</CourseCreditEarned>
        <CourseAcademicGradeScaleCode>65</CourseAcademicGradeScaleCode>
        <CourseAcademicGrade>P</CourseAcademicGrade>
        <CourseSubjectAreaCode>LifePhysicalSciences</CourseSubjectAreaCode>
        <CourseQualityPointsEarned>0</CourseQualityPointsEarned>
        <CourseNumber>4137.F000.A</CourseNumber>
        <CourseTitle>AP-BIO</CourseTitle>
    </Course>

    <Course>
        <CourseCreditBasis>Regular</CourseCreditBasis>
        <CourseCreditUnits>Semester</CourseCreditUnits>
        <CourseCreditValue>0.5</CourseCreditValue>
        <CourseCreditEarned>0.5</CourseCreditEarned>
        <CourseAcademicGradeScaleCode>65</CourseAcademicGradeScaleCode>
        <CourseAcademicGrade>P</CourseAcademicGrade>
        <CourseSubjectAreaCode>PhysicalHealthSafetyEducation</CourseSubjectAreaCode>
        <CourseQualityPointsEarned>0</CourseQualityPointsEarned>
        <CourseNumber>6919.F000.X</CourseNumber>
        <CourseTitle>PEEQ4</CourseTitle>
        <NoteMessage>7P.E./Equivalent</NoteMessage>
    </Course>
</AcademicSession>
</AcademicRecord>
</Student>
</HSTm:HighSchoolTranscript>

```

Appendix G: ISO 639-2 Language Codes http://www.loc.gov/standards/iso639-2/php/code_list.php Sorted by Language Code	
Language Code	Description
AAR	Afar
ABK	Abkhazian
ACE	Achinese
ACH	Acoli
ADA	Adangme
ADY	Adyghe; Adygei
AFA	Afro-Asiatic (Other)
AFH	Afrihili
AFR	Afrikaans
AIN	Ainu
AKA	Akan
AKK	Akkadian
ALB	Albanian
ALE	Aleut
ALG	Algonquian Languages
ALT	Southern Altai
AMH	Amharic
ANG	English, Old (ca. 450-1100)
ANP	Angika
APA	Apache Languages
ARA	Arabic
ARC	Aramaic (700-300 BCE); Imperial Aramaic (700-300 BCE)
ARG	Aragonese
ARM	Armenian
ARN	Mapudungun; Mapuche
ARP	Arapaho
ART	Artificial (Other)
ARW	Arawak
ASM	Assamese
AST	Asturian; Bable
ATH	Athapaskan Languages

Appendix G: ISO 639-2 Language Codes http://www.loc.gov/standards/iso639-2/php/code_list.php Sorted by Language Code	
Language Code	Description
AUS	Australian Languages
AVA	Avaric
AVE	Avestan
AWA	Awadhi
AYM	Aymara
AZE	Azerbaijani
BAD	Banda Languages
BAI	Bamileke Languages
BAM	Bambara
BAN	Balinese
BAQ	Basque
BAS	Basa
BAT	Baltic (Other)
BEJ	Beja
BEL	Belarusian
BEM	Bemba
BEN	Bengali
BER	Berber (Other)
BHO	Bhojpuri
BIH	Bihari
BIK	Bikol
BIN	Bini; Edo
BIS	Bislama
BLA	Siksika
BNT	Bantu (Other)
BOD	Tibetan
BOS	Bosnian
BRA	BRAJ
BRE	Breton
BTK	Batak Languages
BUA	Buriat
BUG	Buginese

Appendix G: ISO 639-2 Language Codeshttp://www.loc.gov/standards/iso639-2/php/code_list.php**Sorted by Language Code**

Language Code	Description
BUL	Bulgarian
BYN	Bilin; Blin
CAD	Caddo
CAI	Central American Indian (Other)
CAR	Galibi Carib
CAT	Catalan; Valencian
CAU	Caucasian (Other)
CEB	Cebuano
CEL	Celtic (Other)
CES	Czech
CHA	Chamorro
CHB	Chibcha
CHE	Chechen
CHG	Chagatai
CHI	Chinese
CHK	Chuukese
CHM	Mari
CHN	Chinook Jargon
CHO	Choctaw
CHP	Chipewyan
CHR	Cherokee
CHU	Church Slavic; Old Slavonic; Church Slavonic; Old Bulgarian; Old Church Slavonic
CHV	Chuvash
CHY	Cheyenne
CMC	Chamic Languages
COP	Coptic
COR	Cornish
COS	Corsican
CPE	Creoles and Pidgins, English Based (Other)
CPF	Creoles and Pidgins, French Based (Other)
CPP	Creoles and Pidgins, Portuguese Based (Other)

Appendix G: ISO 639-2 Language Codes http://www.loc.gov/standards/iso639-2/php/code_list.php Sorted by Language Code	
Language Code	Description
CRE	Cree
CRH	Crimean Tatar; Crimean Turkish
CRP	Creoles and Pidgins (Other)
CSB	Kashubian
CUS	Cushitic (Other)
CYM	Welsh
CZE	Czech
DAK	Dakota
DAN	Danish
DAR	Dargwa
DAY	Dayak (Land) Languages
DEL	Delaware
DEN	Slave (Athapaskan)
DEU	German
DGR	Dogrib
DIN	Dinka
DIV	Divehi; Dhivehi; Maldivian
DOI	Dogri
DRA	Dravidian (Other)
DSB	Lower Sorbian
DUA	Duala
DUM	Dutch, Middle (ca. 1050–1350)
DUT	Dutch; Flemish
DYU	Dyula
DZO	Dzongkha
EFI	Efik
EGY	Egyptian (Ancient)
EKA	Ekajuk
ELL	Greek, Modern (1453-)
ELX	Elamite
ENG	English
ENM	English, Middle (1100-1500)

Appendix G: ISO 639-2 Language Codes	
http://www.loc.gov/standards/iso639-2/php/code_list.php	
Sorted by Language Code	
Language Code	Description
EPO	Esperanto
EST	Estonian
EUS	Basque
EWE	Ewe
EWO	Ewondo
FAN	Fang
FAO	Faroese
FAS	Persian
FAT	Fanti
FIJ	Fijian
FIL	Filipino; Pilipino
FIN	Finnish
FIU	Finno-Ugrian (Other)
FON	Fon
FRA	French
FRE	French
FRM	French, Middle (ca. 1400-1600)
FRO	French, Old (842-ca. 1400)
FRR	Frisian, Northern
FRS	Frisian, Eastern
FRY	Frisian, Western
FUL	Fulah
FUR	Friulian
GAA	Ga
GAY	Gayo
GBA	Gbaya
GEM	Germanic (Other)
GEO	Georgian
GER	German
GEZ	Geez
GIL	Gilbertese
GLA	Gaelic; Scottish Gaelic

Appendix G: ISO 639-2 Language Codes http://www.loc.gov/standards/iso639-2/php/code_list.php Sorted by Language Code	
Language Code	Description
GLE	Irish
GLG	Galician
GLV	Manx
GMH	German, Middle High (ca.1050-1500)
GOH	German, Old High (ca. 750-1050)
GON	Gondi
GOR	Gorontalo
GOT	Gothic
GRB	Grebo
GRC	Greek, Ancient (to 1453)
GRE	Greek, Modern (1453-)
GRN	Guarani
GSW	Swiss German, Alemannic
GUJ	Gujarati
GWI	Gwich'in
HAI	Haida
HAT	Taitian; Haitian Creole
HAU	Hausa
HAW	Hawaiian
HEB	Hebrew
HER	Herero
HIL	Hiligaynon
HIM	Himigaynon
HIN	Hindi
HIT	Hittite
HMN	Hmong
HMO	Hiri Motu
HRV	Croatian
HSB	Sorbian (Upper)
HUN	Hungarian
HUP	Hupa
HYE	Armenian

Appendix G: ISO 639-2 Language Codes http://www.loc.gov/standards/iso639-2/php/code_list.php Sorted by Language Code	
Language Code	Description
IBA	Iban
IBO	Igbo
ICE	Icelandic
IDO	Ido
III	Sichuan Yi
IJO	Ijo Languages
IKU	Inuktitut
ILE	Interlingue
ILO	Iloko
INA	Interlingua (International Auxiliary Language Association)
INC	Indic (Other)
IND	Indonesian
INE	Indo-European (Other)
INH	Ingush
IPK	Inupiaq
IRA	Iranian (Other)
IRO	Iroquoian Languages
ISL	Icelandic
ITA	Italian
JAV	Javanese
JBO	Lojban
JPN	Japanese
JPR	Judeo-Persian
JRB	Judeo-Arabic
KAA	Kara-Kalpak
KAB	Kabyle
KAC	Kachin; Jingpho
KAL	Greenlandic; Kalaallisut
KAM	Kamba
KAN	Kannada
KAR	Karen Languages
KAS	Kashmiri

Appendix G: ISO 639-2 Language Codes http://www.loc.gov/standards/iso639-2/php/code_list.php Sorted by Language Code	
Language Code	Description
KAT	Georgian
KAU	Kanuri
KAW	Kawi
KAZ	Kazakh
KBD	Kabardian
KHA	Khasi
KHI	Khoisan (Other)
KHM	Khmer (Central)
KHO	Khotanese
KIK	Kikuyu; Gikuyu
KIN	Kinyarwanda
KIR	Kirghiz; Kyrgyz
KMB	Kimbundu
KOK	Konkani
KOM	Komi
KON	Kongo
KOR	Korean
KOS	Kosraean
KPE	Kpelle
KRC	Karachay-Balkar
KRL	Karelian
KRO	Kru Languages
KRU	Kurukh
KUA	Kuanyama; Kwanyama
KUM	Kumyk
KUR	Kurdish
KUT	Kutenai
LAD	Ladino
LAH	Lahnda
LAM	Lamba
LAO	Lao
LAT	Latin

Appendix G: ISO 639-2 Language Codes http://www.loc.gov/standards/iso639-2/php/code_list.php Sorted by Language Code	
Language Code	Description
LAV	Latvian
LEZ	Lezghian
LIM	Limburgan; Limburger; Limburgish
LIN	Lithuanian
LOL	Mongo
LOZ	Lozi
LTZ	Luxembourgish; Letzeburgesch
LUA	Luba-Lulua
LUB	Luba-Katanga
LUG	Ganda
LUI	Luiseno
LUN	Lunda
LUO	Luo (Kenya and Tanzania)
LUS	Lushai
MAC	Macedonian
MAD	Madurese
MAG	Magahi
MAH	Marshallese
MAI	Maithili
MAK	Makasar
MAL	Malayalam
MAN	Mandingo
MAO	Maori
MAP	Austronesian (Other)
MAR	Marathi
MAS	Masai
MAY	Malay
MDF	Moksha
MDR	Mandar
MEN	Mende
MGA	Irish, Middle (900-1200)
MIC	Mi'kmaq; Micmac

Appendix G: ISO 639-2 Language Codes http://www.loc.gov/standards/iso639-2/php/code_list.php Sorted by Language Code	
Language Code	Description
MIG	Malagasy
MIN	Minangkabau
MIS	Uncoded Languages
MKD	Macedonian
MKH	Mon-Khmer (Other)
MLT	Maltese
MNC	Manchu
MNI	Manipuri
MNO	Manobo Languages
MOH	Mohawk
MOL	Moldavian
MON	Mongolian
MOS	Mossi
MRI	Maori
MSA	Malay
MUL	Multiple Languages
MUN	Munda Languages
MUS	Creek
MWL	Mirandese
MWR	Marwari
MYA	Burmese
MYA	Burmese
MYN	Mayan Languages
MYV	Erzya
NAH	Nahuatl Languages
NAI	North American Indian
NAP	Neapolitan
NAU	Nauru
NAV	Navajo; Navaho
NBL	Nddbele, South; South Ndebele
NDE	Ndebele, North; North Ndebele
NDO	Ndonga

Appendix G: ISO 639-2 Language Codes http://www.loc.gov/standards/iso639-2/php/code_list.php Sorted by Language Code	
Language Code	Description
NDS	Low German; Low Saxon; German, Low; Saxon, Low
NEP	Nepali
NEW	Nepal Bhasa; Newari
NIA	Nias
NIC	Niger-Kordofanian (Other)
NIU	Niuean
NLD	Dutch, Flemish
NNO	Norwegian Nynorsk; Nynorsk, Norwegian
NOB	Bokmål, Norwegian; Norwegian Bokmål
NOG	Nogai
NON	Norse, Old
NOR	Norwegian
NQO	N'Ko
NSO	Northern Sotho; Pedi; Sepedi
NUB	Nubian Languages
NWC	Nepal Bhasa, Classical; Classical Newari
NYA	Nyanja; Chichewa; Chewa
NYM	Nyamwezi
NYN	Nyankole
NYO	Nyoro
NZI	Nzima
OCI	Occitan (post 1500); Provençal
OJI	Ojibwa
ORI	Oriya
ORM	Oromo
OSA	Osage
OSS	Ossetian; Ossetic
OTA	Turkish, Ottoman (1500-1928)
OTO	Otomian Languages
PAA	Papuan (Other)
PAG	Pangasinan
PAL	Pahlavi

Appendix G: ISO 639-2 Language Codes http://www.loc.gov/standards/iso639-2/php/code_list.php Sorted by Language Code	
Language Code	Description
PAM	Pampanga
PAN	Panjabi; Punjabi
PAP	Papiamento
PAU	Palauan
PEO	Persian, Old (ca. 600-400 B.C.)
PER	Persian
PHI	Philippine (Other)
PHN	Phoenician
PLI	Pali
POL	Polish
PON	Pohnpeian
POR	Portuguese
PRA	Prakrit Languages
PRO	Provençal, Old (to 1500)
PUS	Pushto
QAA	Reserved for Local Use
QTZ	Reserved for Local Use
QUE	Quechua
RAJ	Rajasthani
RAP	Rapanui
RAR	Rarotongan; Cook Islands Maori
ROA	Romance (Other)
ROH	Romansh
ROM	Romany
RON	Romanian
RUM	Romanian
RUN	Rundi
RUP	Aromanian, Arumanian; Macedo-Romanian
RUS	Russian
SAD	Sandawe
SAG	Sango
SAH	Yakut

Appendix G: ISO 639-2 Language Codes http://www.loc.gov/standards/iso639-2/php/code_list.php Sorted by Language Code	
Language Code	Description
SAI	South American Indian (Other)
SAL	Salishan Languages
SAM	Samaritan Aramaic
SAN	Sanskrit
SAS	Sasak
SAT	Santali
SCC	Serbian
SCN	Sicilian
SCO	Scots
SCR	Croatian
SEL	Selkup
SEM	Semitic (Other)
SGA	Irish, Old (to 900)
SGN	Sign Languages
SHN	Shan
SID	Sidamo
SIN	Sinhala; Sinhalese
SIO	Siouan Languages
SIT	Sino-Tibetan (Other)
SLA	Slavic (Other)
SLK	Slovak
SLO	Slovak
SLV	Slovenian
SMA	Southern Sami
SME	Northern Sami
SMI	Sami Languages (Other)
SMJ	Lule Sami
SMN	Inari Sami
SMO	Samoan
SMS	Skolt Sami
SNA	Shona
SND	Sindhi

Appendix G: ISO 639-2 Language Codes http://www.loc.gov/standards/iso639-2/php/code_list.php Sorted by Language Code	
Language Code	Description
SNK	Soninke
SOG	Sogdian
SOM	Somali
SON	Songhai Languages
SOT	Sotho, Southern
SPA	Spanish, Castilian
SQI	Albanian
SQI	Albanian
SRD	Sardinian
SRN	Sranan Tongo
SRP	Serbian
SRR	Serer
SSA	Nilo-Saharan (Other)
SSW	Swati
SUK	Sukuma
SUN	Sundanese
SUS	Susu
SUX	Sumerian
SWA	Swahili
SWE	Swedish
SYC	Syriac, Classical
SYR	Syriac
TAH	Tahitian
TAI	Tai (Other)
TAM	Tamil
TAT	Tatar
TEL	Telugu
TEM	Timne
TER	Tereno
TET	Tetum
TGK	Tajik
TGL	Tagalog

Appendix G: ISO 639-2 Language Codes http://www.loc.gov/standards/iso639-2/php/code_list.php Sorted by Language Code	
Language Code	Description
THA	Thai
TIB	Tibetan
TIB	Tibetan
TIG	Tigre
TIR	Tigrinya
TIV	Tiv
TKL	Tokelau
TLH	TlhIngan-Hol; Klingon
TLI	Tlingit
TMH	Tamashek
TOG	Tonga (Nyasa)
TON	Tonga (Tonga Islands)
TPI	Tok Pisin
TSI	Tsimshian
TSN	Tswana
TSO	Tsonga
TUK	Turkmen
TUM	Tumbuka
TUP	Tupi Languages
TUR	Turkish
TUT	Altaic (Other)
TVL	Tuvalu
TWI	Twi
TYV	Tuvinian
UDM	Udmurt
UGA	Ugaritic
UIG	Uighur; Uyghur
UKR	Ukrainian
UMB	Umbundu
UND	Undetermined
URD	Urdu
UZB	Uzbek

Appendix G: ISO 639-2 Language Codes	
http://www.loc.gov/standards/iso639-2/php/code_list.php	
Sorted by Language Code	
Language Code	Description
VAI	Vai
VEN	Venda
VIE	Vietnamese
VOL	Volapük
VOT	Votic
WAK	Wakashan Languages
WAL	Walamo
WAR	Waray
WAS	Washo
WEL	Welsh
WEN	Sorbian Languages
WLN	Walloon
WOL	Wolof
XAL	Kalmyk; Oirat
XHO	Xhosa
YAO	Yao
YAP	Yapese
YID	Yiddish
YOR	Yoruba
YPK	Yupik Languages
ZAP	Zapotec
ZEN	Zenaga
ZHA	Zhuang; Chuang
ZHO	Chinese
ZND	Zande languages
ZUL	Zulu
ZUN	Zuni
ZXX	No linguistic content
ZZA	Zaza; Dimili; Dimli; Kirdki; Kirmanjki; Zazaki

Appendix G: ISO 639-2 Language Codes http://www.loc.gov/standards/iso639-2/php/code_list.php Sorted by Name of Language	
Language Code	Description
AAR	Afar
ABK	Abkhazian
ACE	Achinese
ACH	Acoli
ADA	Adangme
ADY	Adyghe; Adygei
AFH	Afrihili
AFR	Afrikaans
AFA	Afro-Asiatic (Other)
AIN	Ainu
AKA	Akan
AKK	Akkadian
ALB	Albanian
SQI	Albanian
SQI	Albanian
ALE	Aleut
ALG	Algonquian Languages
TUT	Altaic (Other)
AMH	Amharic
ANP	Angika
APA	Apache Languages
ARA	Arabic
ARG	Aragonese
ARC	Aramaic (700-300 BCE); Imperial Aramaic (700-300 BCE)
ARP	Arapaho
ARW	Arawak
ARM	Armenian
HYE	Armenian
RUP	Aromanian, Arumanian; Macedo-Romanian
ART	Artificial (Other)

Appendix G: ISO 639-2 Language Codes http://www.loc.gov/standards/iso639-2/php/code_list.php Sorted by Name of Language	
Language Code	Description
ASM	Assamese
AST	Asturian; Bable
ATH	Athapascan Languages
DEN	Athapascan Slave
AUS	Australian Languages
MAP	Austronesian (Other)
AVA	Avaric
AVE	Avestan
AWA	Awadhi
AYM	Aymara
AZE	Azerbaijani
AST	Bable, Asturian
BAN	Balinese
BAT	Baltic (Other)
BAM	Bambara
BAI	Bamileke Languages
BAD	Banda Languages
BNT	Bantu (Other)
BAS	Basa
BAQ	Basque
EUS	Basque
BTK	Batak Languages
BEJ	Beja
BEL	Belarusian
BEM	Bemba
BEN	Bengali
BER	Berber (Other)
BHO	Bhojpuri
BIH	Bihari
BIK	Bihari
BYN	Bilin; Blin
BIN	Bini; Edo

Appendix G: ISO 639-2 Language Codes http://www.loc.gov/standards/iso639-2/php/code_list.php Sorted by Name of Language	
Language Code	Description
BIS	Bislama
BYN	Blin; Bilin
NOB	Bokmål, Norwegian; Norwegian Bokmål
BOS	Bosnian
BRA	BRAJ
BRE	Breton
BUG	Buginese
BUL	Bulgarian
CHU	Bulgarian (Old); Church Slavic; Old Slavonic; Church Slavonic; Old Church Slavonic
BUA	Buriat
MYA	Burmese
MYA	Burmese
CAD	Caddo
CAT	Catalan; Valencian
CAU	Caucasian (Other)
CEB	Cebuano
CEL	Celtic (Other)
CAI	Central American Indian (Other)
CHG	Chagatai
CMC	Chamic Languages
CHA	Chamorro
CHE	Chechen
CHR	Cherokee
CHY	Cheyenne
CHB	Chibcha
NYA	Chichewa; Chewa; Nyanja
CHI	Chinese
ZHO	Chinese
ZHO	Chinese
CHN	Chinook Jargon
CHP	Chipewyan

Appendix G: ISO 639-2 Language Codes http://www.loc.gov/standards/iso639-2/php/code_list.php Sorted by Name of Language	
Language Code	Description
CHO	Choctaw
ZHA	Chuang; Zhuang
CHU	Church Slavic; Old Slavonic; Church Slavonic; Old Bulgarian; Old Church Slavonic
CHK	Chuukese
CHV	Chuvash
RAR	Cook Islands Maori; Rarotongan
COP	Coptic
COR	Cornish
COS	Corsican
CRE	Cree
MUS	Creek
CRP	Creoles and Pidgins (Other)
CPE	Creoles and Pidgins, English Based (Other)
CPF	Creoles and Pidgins, French Based (Other)
CPP	Creoles and Pidgins, Portuguese Based (Other)
CRH	Crimean Tatar; Crimean Turkish
HRV	Croatian
SCR	Croatian
CUS	Cushitic (Other)
CES	Czech
CZE	Czech
DAK	Dakota
DAN	Danish
DAR	Dargwa
DAY	Dayak (Land) Languages
DEL	Delaware
ZZA	Dimili; Dimli; Kirdki; Kirmanjki; Zazaki; Zaza
DIN	Dinka
DIV	Divehi; Dhivehi; Maldivian
DOI	Dogri
DGR	Dogrib

Appendix G: ISO 639-2 Language Codes http://www.loc.gov/standards/iso639-2/php/code_list.php Sorted by Name of Language	
Language Code	Description
DRA	Dravidian (Other)
DUA	Duala
NLD	Dutch, Flemish
DUM	Dutch, Middle (ca. 1050–1350)
DUT	Dutch; Flemish
NLD	Dutch; Flemish
DYU	Dyula
DZO	Dzongkha
BIN	Edo; Bini
EFI	Efik
EGY	Egyptian (Ancient)
EKA	Ekajuk
ELX	Elamite
ENG	English
ENM	English, Middle (1100-1500)
ANG	English, Old (ca. 450-1100)
MYV	Erzya
EPO	Esperanto
EST	Estonian
EWE	Ewe
EWO	Ewondo
FAN	Fang
FAT	Fanti
FAO	Faroese
FIJ	Fijian
FIL	Filipino; Pilipino
FIN	Finnish
FIU	Finno-Ugrian (Other)
DUT	Flemish; Dutch
NLD	Flemish; Dutch
FON	Fon
FRA	French

Appendix G: ISO 639-2 Language Codes http://www.loc.gov/standards/iso639-2/php/code_list.php Sorted by Name of Language	
Language Code	Description
FRE	French
FRM	French, Middle (ca. 1400-1600)
FRO	French, Old (842-ca. 1400)
FRS	Frisian, Eastern
FRR	Frisian, Northern
FRY	Frisian, Western
FUR	Friulian
FUL	Fulah
GAA	Ga
GLA	Gaelic; Scottish Gaelic
CAR	Galibi Carib
GLG	Galician
LUG	Ganda
GAY	Gayo
GBA	Gbaya
GEZ	Geez
GEO	Georgian
KAT	Georgian
DEU	German
GER	German
GSW	German (Swiss); Alemannic
NDS	German, Low; Saxon, Low
GMH	German, Middle High (ca.1050-1500)
GOH	German, Old High (ca. 750-1050)
GEM	Germanic (Other)
KIK	Gikuyu; Kikuyu
GIL	Gilbertese
GON	Gondi
GOR	Gorontalo
GOT	Gothic
GRB	Grebo
GRC	Greek, Ancient (to 1453)

Appendix G: ISO 639-2 Language Codes http://www.loc.gov/standards/iso639-2/php/code_list.php Sorted by Name of Language	
Language Code	Description
ELL	Greek, Modern (1453-)
GRE	Greek, Modern (1453-)
KAL	Greenlandic; Kalaallisut
GRN	Guarani
GUJ	Gujarati
GWI	Gwich'in
HAI	Haida
HAU	Hausa
HAW	Hawaiian
HEB	Hebrew
HER	Herero
HIL	Hiligaynon
HIM	Himigaynon
HIN	Hindi
HMO	Hiri Motu
HIT	Hittite
HMN	Hmong
HUN	Hungarian
HUP	Hupa
IBA	Iban
ICE	Icelandic
ISL	Icelandic
IDO	Ido
IBO	Igbo
IJO	Ijo Languages
ILO	Iloko
SMN	Inari Sami
NAI	Indian, North American
SAI	Indian, South American (Other)
INC	Indic (Other)
INE	Indo-European (Other)
IND	Indonesian

Appendix G: ISO 639-2 Language Codes http://www.loc.gov/standards/iso639-2/php/code_list.php Sorted by Name of Language	
Language Code	Description
INH	Ingush
INA	Interlingua (International Auxiliary Language Association)
ILE	Interlingue
IKU	Inuktitut
IPK	Inupiaq
IRA	Iranian (Other)
GLE	Irish
MGA	Irish, Middle (900-1200)
SGA	Irish, Old (to 900)
IRO	Iroquoian Languages
ITA	Italian
JPN	Japanese
JAV	Javanese
KAC	Jingpho; Kachin
JRB	Judeo-Arabic
JPR	Judeo-Persian
KBD	Kabardian
KAB	Kabyle
KAC	Kachin; Jingpho
KAL	Kalaallisut; Greenlandic
XAL	Kalmyk; Oirat
KAM	Kamba
KAN	Kannada
KAU	Kanuri
KRC	Karachay-Balkar
KAA	Kara-Kalpak
KRL	Karelian
KAR	Karen Languages
KAS	Kashmiri
CSB	Kashubian
KAW	Kawi
KAZ	Kazakh

Appendix G: ISO 639-2 Language Codes http://www.loc.gov/standards/iso639-2/php/code_list.php Sorted by Name of Language	
Language Code	Description
KHA	Khasi
KHM	Khmer (Central)
KHI	Khoisan (Other)
KHO	Khotanese
KIK	Kikuyu; Gikuyu
KMB	Kimbundu
KIN	Kinyarwanda
ZZA	Kirdki; Kirmanjki; Zazaki; Zaza; Dimili; Dimli;
KIR	Kirghiz; Kyrgyz
TLH	Klingon; tlhIngan-Hol
KOM	Komi
KON	Kongo
KOK	Konkani
KOR	Korean
KOS	Kosraean
KPE	Kpelle
KRO	Kru Languages
KUA	Kuanyama; Kwanyama
KUM	Kumyk
KUR	Kurdish
KRU	Kurukh
KUT	Kutenai
LAD	Ladino
LAH	Lahnda
LAM	Lamba
LAO	Lao
LAT	Latin
LAV	Latvian
LEZ	Lezghian
LIM	Limburgan; Limburger; Limburgish
LIN	Lithuanian
JBO	Lojban

Appendix G: ISO 639-2 Language Codes http://www.loc.gov/standards/iso639-2/php/code_list.php Sorted by Name of Language	
Language Code	Description
NDS	Low German; Low Saxon; German, Low; Saxon, Low
DSB	Lower Sorbian
LOZ	Lozi
LUB	Luba-Katanga
LUA	Luba-Lulua
LUI	Luiseno
SMJ	Lule Sami
LUN	Lunda
LUO	Luo (Kenya and Tanzania)
LUS	Lushai
LTZ	Luxembourgish; Letzeburgesch
MAC	Macedonian
MKD	Macedonian
RUP	Macedo-Romanian; Aromanian, Arumanian
MAD	Madurese
MAG	Magahi
MAI	Maithili
MAK	Makasar
MIG	Malagasy
MAY	Malay
MSA	Malay
MAL	Malayalam
DIV	Maldivian; Divehi; Dhivehi
MLT	Maltese
MNC	Manchu
MDR	Mandar
MAN	Mandingo
MNI	Manipuri
MNO	Manobo Languages
GLV	Manx
MAO	Maori
MRI	Maori

Appendix G: ISO 639-2 Language Codes http://www.loc.gov/standards/iso639-2/php/code_list.php Sorted by Name of Language	
Language Code	Description
ARN	Mapudungun; Mapuche
MAR	Marathi
CHM	Mari
MAH	Marshallese
MWR	Marwari
MAS	Masai
MYN	Mayan Languages
MEN	Mende
MIC	Mi'kmaq; Micmac
MIN	Minangkabau
MWL	Mirandese
MOH	Mohawk
MDF	Moksha
MOL	Moldavian
LOL	Mongo
MON	Mongolian
MKH	Mon-Khmer (Other)
MOS	Mossi
MUL	Multiple Languages
MUN	Munda Languages
NQO	N'Ko
NAH	Nahuatl Languages
NAU	Nauru
NAV	Navajo; Navaho
NBL	Nddbele, South; South Ndebele
NDE	Ndebele, North; North Ndebele
NDO	Ndonga
NAP	Neapolitan
NWC	Nepal Bhasa, Classical; Classical Newari
NEW	Nepal Bhasa; Newari
NEP	Nepali
NWC	Newari, Classical; Old Newari; Classical Nepal Bhasa

Appendix G: ISO 639-2 Language Codes http://www.loc.gov/standards/iso639-2/php/code_list.php Sorted by Name of Language	
Language Code	Description
NIA	Nias
NIC	Niger-Kordofanian (Other)
SSA	Nilo-Saharan (Other)
NIU	Niuean
ZXX	No linguistic content
NOG	Nogai
NON	Norse, Old
NAI	North American Indian
SME	Northern Sami
NSO	Northern Sotho; Pedi; Sepedi
NOR	Norwegian
NNO	Norwegian Nynorsk; Nynorsk, Norwegian
NUB	Nubian Languages
NYM	Nyamwezi
NYA	Nyanja; Chichewa; Chewa
NYN	Nyankole
NYO	Nyoro
NZI	Nzima
OCI	Occitan (post 1500); Provençal
XAL	Oirat; Kalmyk
OJI	Ojibwa
ORI	Oriya
ORM	Oromo
OSA	Osage
OSS	Ossetian; Ossetic
OTO	Otomian Languages
PAL	Pahlavi
PAU	Palauan
PLI	Pali
PAM	Pampanga
PAG	Pangasinan
PAN	Panjabi; Punjabi

Appendix G: ISO 639-2 Language Codes http://www.loc.gov/standards/iso639-2/php/code_list.php Sorted by Name of Language	
Language Code	Description
PAP	Papiamento
PAA	Papuan (Other)
NSO	Pedi; Sepedi; Northern Sotho
FAS	Persian
PER	Persian
PER	Persian
PEO	Persian, Old (ca. 600-400 B.C.)
PHI	Philippine (Other)
PHN	Phoenician
FIL	Pilipino; Filipino
PON	Pohnpeian
POL	Polish
POR	Portuguese
PRA	Prakrit Languages
PRO	Provençal, Old (to 1500)
PAN	Punjabi; Panjabi
PUS	Pushto
QUE	Quechua
RAJ	Rajasthani
RAP	Rapanui
RAR	Rarotongan; Cook Islands Maori
QAA	Reserved for Local Use
QTZ	Reserved for Local Use
ROA	Romance (Other)
RON	Romanian
RUM	Romanian
ROH	Romansh
ROM	Romany
RUN	Rundi
RUS	Russian
SSA	Saharan, Nilo (Other)
SAL	Salishan Languages

Appendix G: ISO 639-2 Language Codes http://www.loc.gov/standards/iso639-2/php/code_list.php Sorted by Name of Language	
Language Code	Description
SAM	Samaritan Aramaic
SMI	Sami Languages (Other)
SMN	Sami, Inari
SMJ	Sami, Lule
SME	Sami, Northern
SMS	Sami, Skolt
SMA	Sami, Southern
SMO	Samoan
SAD	Sandawe
SAG	Sango
SAN	Sanskrit
SAT	Santali
SRD	Sardinian
SAS	Sasak
NDS	Saxon, Low; German, Low
SCO	Scots
GLA	Scottish Gaelic
SEL	Selkup
SEM	Semitic (Other)
SCC	Serbian
SRP	Serbian
SRR	Serer
SHN	Shan
SNA	Shona
III	Sichuan Yi
SCN	Sicilian
SID	Sidamo
SGN	Sign Languages
BLA	Siksika
SND	Sindhi
SIN	Sinhala; Sinhalese
SIT	Sino-Tibetan (Other)

Appendix G: ISO 639-2 Language Codes http://www.loc.gov/standards/iso639-2/php/code_list.php Sorted by Name of Language	
Language Code	Description
SIO	Siouan Languages
SMS	Skolt Sami
DEN	Slave (Athapascan)
CHU	Slavic (Church); Old Slavonic; Church Slavonic; Old Bulgarian; Old Church Slavonic
SLA	Slavic (Other)
SLK	Slovak
SLO	Slovak
SLV	Slovenian
SOG	Sogdian
SOM	Somali
SON	Songhai Languages
SNK	Soninke
HSB	Sorbian (Upper)
WEN	Sorbian Languages
DSB	Sorbian, Lower
NSO	Sotho, Northern; Pedi; Sepedi
SOT	Sotho, Southern
SAI	South American Indian (Other)
ALT	Southern Altai
SMA	Southern Sami
SPA	Spanish, Castilian
SRN	Sranan Tongo
SUK	Sukuma
SUX	Sumerian
SUN	Sundanese
SUS	Susu
SWA	Swahili
SSW	Swati
SWE	Swedish
GSW	Swiss German, Alemannic
SYR	Syriac

Appendix G: ISO 639-2 Language Codes http://www.loc.gov/standards/iso639-2/php/code_list.php Sorted by Name of Language	
Language Code	Description
SYC	Syriac, Classical
TGL	Tagalog
TAH	Tahitian
TAI	Tai (Other)
HAT	Taitian; Haitian Creole
TGK	Tajik
TMH	Tamashek
TAM	Tamil
TAT	Tatar
CRH	Tatar (Crimean); Crimean Turkish
TEL	Telugu
TER	Tereno
TET	Tetum
THA	Thai
BOD	Tibetan
TIB	Tibetan
TIB	Tibetan
TIG	Tigre
TIR	Tigrinya
TEM	Timne
TIV	Tiv
TLH	TlhIngan-Hol; Klingon
TLI	Tlingit
TPI	Tok Pisin
TKL	Tokelau
TOG	Tonga (Nyasa)
TON	Tonga (Tonga Islands)
SRN	Tongo, Sranan
TSI	Tsimshian
TSO	Tsonga
TSN	Tswana
TUM	Tumbuka

Appendix G: ISO 639-2 Language Codes http://www.loc.gov/standards/iso639-2/php/code_list.php Sorted by Name of Language	
Language Code	Description
TUP	Tupi Languages
TUR	Turkish
CRH	Turkish (Crimean); Crimean Tatar
OTA	Turkish, Ottoman (1500-1928)
TUK	Turkmen
TVL	Tuvalu
TYV	Tuvinian
TWI	Twi
UDM	Udmurt
UGA	Ugaritic
UIG	Uighur; Uyghur
UKR	Ukrainian
UMB	Umbundu
MIS	Uncoded Languages
UND	Undetermined
URD	Urdu
UZB	Uzbek
VAI	Vai
CAT	Valencian; Catalan
VEN	Venda
VIE	Vietnamese
VOL	Volapük
VOT	Votic
WAK	Wakashan Languages
WAL	Walamo
WLN	Walloon
WAR	Waray
WAS	Washo
CYM	Welsh
WEL	Welsh
WEL	Welsh
WOL	Wolof

Appendix G: ISO 639-2 Language Codes http://www.loc.gov/standards/iso639-2/php/code_list.php Sorted by Name of Language	
Language Code	Description
XHO	Xhosa
SAH	Yakut
YAO	Yao
YAP	Yapese
YID	Yiddish
YOR	Yoruba
YPK	Yupik Languages
ZND	Zande languages
ZAP	Zapotec
ZZA	Zaza; Dimili; Dimli; Kirdki; Kirmanjki; Zazaki
ZEN	Zenaga
ZHA	Zhuang; Chuang
ZUL	Zulu
ZUN	Zuni

Appendix H

Record of Changes Made to Schema and the Guide Since Version 1.0.0

Version 1.0.0

The initial version of the Implementation Guide was issued when the standard was approved in June 2006.

Version 1.0.1

Version 1.0.1 was issued in March 2007. The reason Version 1.0.1 of the Guide was created was multiple errors in Appendix F (Sample Instance Document) were found. Appendix F in Version 1.0.0 of the Implementation Guide has been replaced by a new sample instance document.

In addition, a new appendix G has been added which lists ISO language codes which are used in the schema.

Version 1.0.2

Version 1.0.2 was issued in December 2007 to try again to get the sample instance document corrected in Appendix F. Randy Dueck from the University of Lethbridge pointed out additional errors in the sample transcript after Version 1.0.1 was released.

And most of the schema diagrams were also replaced to correct cardinality implied by the diagrams. The tables below the diagrams were correct and not changed, except for cosmetic changes.

At this point, all the changes to the Implementation Guide are still based on version 1.0.0 of the schema which has not yet been changed.

Appendix J – Members of Workgroup to Develop the PESC XML High School Transcript Standard

PESC XML High School Transcript Workgroup		
No.	Name	Title Company/Association/School
1	Bruce Marton, Chair	Asso. Director of Student Information Systems, Office of Registrar University of Texas at Austin, and member of the AACRAO SPEEDE Committee
2	Carol Alexander	OHLAP Scholarship Coordinator Oklahoma State Regents for Higher Education
3	Barbara Andrepont	Chair, ETranscript Task Force and ESP Solution Group Schools Interoperability Framework (SIF) Liaison
4	Dave Balberchak	Project Manager, AES/PHEAA's Transcript Exchange Services American Education Services
5	Jim Baumann	Chief Information Officer Georgia Student Finance Commission
6	Michael Berberet	Pearson Government Solutions
7	Barry Billing	Electronic Transcripts Specialist Ontario Colleges Application Centre, and member of the AACRAO SPEEDE Committee
8	Jerry Bracken	System Engineer Brigham Young University (UT)
9	L. Russ Brawn	Chief Operations Officer California School Information Services (K12)
10	Cindy Brown	Senior Coordinator for Student Preparation Oklahoma State Regents for Higher Education
11	John Broz	Georgia Bd. of Regents, Office of Information & Instructional Technology
12	Renée Clark	Princeton Review
13	Barbara S. Clements	Member of SIF, and Vice President for Education Services ESP Solutions Group
14	Mark N. Cohen	Vice President, Product Development Docufide, Inc.
15	Margaret Dillard	Project Coordinator, Office of Information & Instructional Technology University System of Georgia

PESC XML High School Transcript Workgroup		
No.	Name	Title Company/Association/School
16	Bryce Fair	Associate Vice Chancellor Scholarships and Grants Oklahoma State Regents for Higher Education
17	Doug Falk	Chief Information Officer National Student Clearinghouse
18	Sam Fugazzotto	District Registrar New Trier Township High School (Illinois)
19	Robin S. Greene	Associate Director, Technology and Internet Services The College Foundation of North Carolina
20	Ed Hauser	Chairman, SCT Banner Student & Financial Aid Systems SunGardSCT
21	Doug Holmes	Ontario Universities Admissions Centre
22	Donna Huber	Manager of Operations for California AES
23	George Hudachek	Associate Director of Admissions University of Minnesota - Twin Cities
24	Alex Jackl	Senior Integration Architect ESP Solutions Group
25	Lavon Jones	The College Foundation, Inc, Raleigh, NC
26	Rob Killion	Executive Director The Common Application, Inc.
27	Jennifer Kim	Membership Services Manager PESC
28	Kim Koran	EA Support Team, OCIO, Consultant, US Department of Education
29	Tonya Lam	Associate Vice Chancellor, Student Affairs University System of Georgia
30	Jan Langtry	Special Projects Administrator California School Information Services (K12)
31	Robert G. Layton, II	President, KEL Group, Inc.
32	Steve Margenau	Great Lakes Educational Loan Services

PESC XML High School Transcript Workgroup		
No.	Name	Title Company/Association/School
33	Michael A. Merrill	Business Information Specialist South Dakota Board of Regents
34	Ron Miller	High School Counselor Natick High School in Massachusetts
35	Steve Mills	Implementation Specialist California School Information Services (K12)
36	Faye Mitcham	Software Application Specialist (SunGardSCT Banner Specialist) Georgia Department of Technical & Adult Education
37	David K. Moldoff	President and Chief Executive Officer Strategic Explorers
38	Bob Morley	Associate Registrar University of Southern California
39	Peggi Munkittrick	Executive Director, Product Strategy Academy One, Inc. (Strategic Explorers)
40	Gregory G. Nadeau	Member of SIF Board, and VP for Expert Advisory Services ESP Solutions Group
41	Paul M. Nations	Senior Systems Programmer Arkansas Department of Higher Education
42	R. Bruce Nielsen	Senior Tech Associate, Enterprise Standards, Information Technology ACT, Inc.
43	Beverly Norwood	Office of Information & Instructional Technology University System of Georgia
44	Karen Nunn	Office of Information & Instructional Technology University System of Georgia
45	John Reese	Chief Executive Officer and Chairman of the Board Docufide, Inc.
46	Ed Roberts	Application Systems Analyst III Oklahoma State Regents for Higher Education
47	Jason Schlotterback	Software Developer Pearson Government Solutions
48	John Scott	Director, New Jersey Statewide Transfer Initiative Burlington County College (NJ)

PESC XML High School Transcript Workgroup		
No.	Name	Title Company/Association/School
49	Michael Sessa	Executive Director PESC
50	Les Smith	SunGardSCT
51	Clare Smith-Larson	SPEEDE, Project EASIER Coordinator Iowa State University, and chair of the AACRAO SPEEDE Committee
52	Ricky Steele	Director of Software Development Oklahoma State Regents for Higher Education
53	John T “Tom” Stewart	Miami Dade College (Retired) and member of AACRAO SPEEDE Committee
54	David Stones	Registrar Southwestern University (TX), and member of AACRAO SPEEDE Committee
55	Pam Summers	Director, Student Applications - EAS Office of Information & Instructional Technology University System of Georgia
56	Cindy Taylor	Information Analyst 1, Academic & Fiscal Affairs University System of Georgia
57	Tom Vreeland	Architect and Chief Technologist OpenVES.org
58	Barbara Waring	Business Analyst, Statewide SIS Project Georgia Department of Education
59	Howard Woodard	Georgia Department of Education
60	Lin Zhou	Senior Manager of Development, Academy One Strategic Explorers
61	Bill Zimmer	Advisory Consultant SunGardSCT (Now SunGard Higher Education)