

# BRASS INDEX

---

## BRASS FITTINGS

Air Brake (Copper Tubing).....	662-663
Air Brake Fittings (Rubber Hose).	680
Compression.....	658-660
Double Compression.....	690
Inverted Flare.....	687-689
John Guest.....	677B
NTA Fittings.....	670-671
Pipe Brass.....	651-653
Press To Connect.....	676-677A
Prestolok.....	673
Prestomatic.....	674-675
SAE 45 <sup>o</sup> Flare.....	682-684

## MISCELLANEOUS

Air Brake Hose.....	678
Air Brake Hose End Kits.....	679
Brakecoil.....	701
Brakelines (steel).....	692-693
Copper Tubing.....	655
Nylon Tubing.....	667-668
Steel Tubing.....	655-656
Weather-head Cross Reference..	707-710

## VALVES

Ball Valves.....	695
Drain Cocks.....	698
Shutoff Cocks.....	697
Tank Valves.....	699
Truck Valves.....	696

# PIPE BRASS FITTINGS

**Advantages:**

All pipe fitting threads are made to Dryseal standards. Connectors, unions, nuts and extruded elbows and tees are machined from CA 360 and CA 345 brass rod; forged elbows and tees are machined from CA 377 brass.

**Specifications:**

Meets functional requirements of the SAE, ASME and ASA.

**Applications:**

Use with brass, copper or iron pipe. Manufactured for low and medium pressure line connection work.

**Temperature and Working Pressure Ranges:**

From -65° to +250°F at 1000 PSI.

**HEX HEAD PLUG**

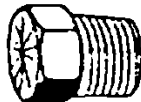

J&B #	PIPE THREAD	QTY
22321	1/8	10
20440	1/4	10
23012	3/8	5
23013	1/2	5
52765	3/4	5

**CAP**

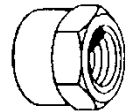

J&B #	PIPE THREAD	QTY
52766	1/8	10
20322	1/4	10
20323	3/8	5
20324	1/2	5
42700	3/4	2

**SQUARE HEAD PLUG**



J&B #	PIPE THREAD	QTY
23014	1/8	10
23015	1/4	10
23016	3/8	5
23017	1/2	5
V46101	3/4	5

**BUSHING**



J&B #	MALE PIPE	FEMALE PIPE	QTY
20412	1/4	1/8	10
20413	3/8	1/8	10
20414	3/8	1/4	10
23020	1/2	1/8	5
23021	1/2	1/4	5
23022	1/2	3/8	5
23023	3/4	3/8	2
23024	3/4	1/2	2

**SLOTTED PLUG**



J&B #	PIPE THREAD	QTY
23018	1/8	20

# PIPE BRASS FITTINGS

## ADAPTER

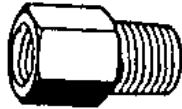

J&B #	FEMALE PIPE	MALE PIPE	QTY
52665	1/8	1/8	5
52666	1/4	1/8	5
52667	1/4	1/4	5
52668	3/8	1/4	5
52669	3/8	3/8	5
52672	1/2	1/4	5
52670	1/2	3/8	5
52671	1/2	1/2	2
52673	3/4	1/2	2

## LONG NIPPLE



J&B #	PIPE THREAD	LENGTH	QTY
23037	1/8	1-1/2	10
23039	1/8	2	10
23038	1/4	1-1/2	5
23040	1/4	2	5
20364	3/8	1-1/2	5
20365	3/8	2	5
20366	3/8	2-1/2	5
23006	3/8	3	5
23019	1/2	1-1/2	5
20370	1/2	2	5
20369	1/2	2-1/2	5

## HEX NIPPLE



J&B #	PIPE THREAD	QTY
23033	1/8	20
23034	1/4	10
23035	3/8	10
23008	1/2	5
23007	3/4	2

## CROSS

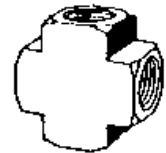

J&B #	PIPE THREAD	QTY
52675	1/8	5
52676	1/4	5
52677	3/8	5

## HEX REDUCE NIPPLE



J&B #	MALE PIPE	MALE PIPE	QTY
V46104	3/8	1/4	10
V46103	1/2	3/8	10
V46102	3/4	1/2	5

## CLOSE NIPPLE



J&B #	PIPE THREAD	QTY
20415	1/8	10
20416	1/4	10
20417	3/8	10
23036	1/2	5
46117	3/4	5

# BULKHEAD FITTINGS

**JB NO V46110 5/BX**



1/4 F--Pipe  
1/2 M-Pipe  
3/4-16 All Steel  
1-11/16 Long

**JB NO 38517 5/BX**



3/8 F--Pipe  
1/2 M-Pipe  
1-14 All Steel  
1-11/16 Long

**JB NO V46106 2/BX**



1/4 F--Pipe Brass Body  
1/2 M-Pipe (Both Ends)  
1-14 Steel Nut  
2-7/8 Long

**JB NO V46111 5/BX**



3/8 F--Pipe  
1/2 M-Pipe Brass Body  
1-14 Brass Nut  
1-11/16 Long

**JB NO 38510 5/BX**



1/4 F--Pipe (Both Ends)  
Brass Body  
3/4-16 Steel Nut  
1-1/2 Long

**JB NO 38515 5/BX**



3/8 F-Pipe (Both Ends)  
Brass Body  
1-14 Steel Nut  
1-5/16 Long

**JB NO V46109 5/BX**



3/8 OD Tubing  
3/8 F-Pipe Brass Body  
7/8-20 Brass Nut  
1-3/4 Long

**JB NO V46108 5/BX**



1/2 OD Tubing  
3/8 F-Pipe Brass Body  
7/8-20 Brass Nut  
1-15/16 Long

**JB NO 40447 5/BX**



1/2 F-Pipe (Both Ends)  
Brass Body  
1-1/8-14 Brass Nut  
1-1/2 Long

# PIPE BRASS FITTINGS

## COUPLING



J&B #	PIPE THREAD	QTY
23025	1/8	10
23026	1/4	10
23027	3/8	5
23028	1/2	5
52663	3/4	2

## TEE



J&B #	PIPE THREAD	QTY
23053	1/8	5
23054	1/4	5
23055	3/8	5
23056	1/2	2
46096	3/4	2

## REDUCER COUP



J&B #	PIPE THREAD	QTY
23029	1/4 x 1/8	10
23030	3/8 x 1/8	5
23031	3/8 x 1/4	5
23032	1/2 x 3/8	5
46097	3/4 X 1/2	2

## 45° STREET ELB



J&B #	PIPE THREAD	QTY
23041	1/8	5
23042	1/4	5
23043	3/8	5
23044	1/2	2
46098	3/4	2

## STREET TEE

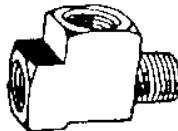

J&B #	PIPE THREAD	QTY
23057	1/8	5
23058	1/4	5
52684	3/8	5
52685	1/2	2
46099	3/4	2

## 90° STREET ELB

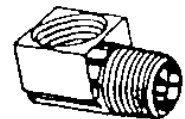

J&B #	PIPE THREAD	QTY
23045	1/8	10
23046	1/4	10
23047	3/8	5
23048	1/2	5
46115	3/4	2

## 90° ELBOW

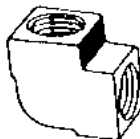

J&B #	PIPE THREAD	QTY
23049	1/8	10
23050	1/4	10
23051	3/8	5
23052	1/2	2
46116	3/4	2

## MALE BRANCH TEE

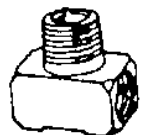

J&B #	PIPE THREAD	QTY
52680	1/8	5
52681	1/4	5
52682	3/8	2
52662	1/2	2

# PIPE BRASS FITTINGS

## HEX HEAD PLUG

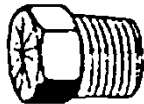

J&B #	BASE#	PIPE THREAD	QTY
59000	23012	3/8	5
59029	23013	1/2	5

## SQUARE HEAD PLUG



J&B #	BASE#	PIPE THREAD	QTY
59001	V46101	3/4	5

## 90° STREET ELB

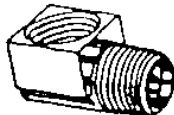

J&B #	BASE#	PIPE THREAD	QTY
59007	23046	1/4	10
59008	23047	3/8	5

## BUSHING



J&B#	BASE#	MALE PIPE	FEMALE PIPE	QTY
59030	20414	3/8	1/4	10
59002	23022	1/2	3/8	5
59003	23024	3/4	1/2	2

## HEX NIPPLE



J&B #	BASE#	PIPE THREAD	QTY
59005	23034	1/4	10
59026	23035	3/8	10
59006	23008	1/2	5

## ADAPTER



J&B#	BASE#	MALE PIPE	FEMALE PIPE	QTY
59004	52670	1/2	3/8	5

## EXTERNAL SEAL DRAIN COCK

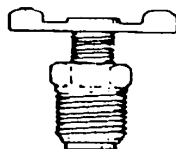

J&B #	BASE#	PIPE THREAD	QTY
59025	20438	1/4	10

# TUBING

## COPPER TUBING

- Top quality, seamless annealed automotive grade.



J&B #	TUBE SIZE	WALL GAUGE	LENGTH
24139	1/8	.030	50'
24140	3/16	.030	50'
24141	1/4	.030	50'
24142	5/16	.032	50'
24143	3/8	.032	50'
24144	1/2	.032	50'
24145	5/8	.035	50'
24146	3/4	.035	50'

## COILED STEEL TUBING

- Coiled tubing that bends and flares easily.
- This tubing can be used for automotive, farm and industrial application.

J&B #	TUBE SIZE	LENGTH
41227	3/16	25'
41235	1/4	25'
41238	5/16	25'
41236	3/8	25'



# TUBING

## NICOPP CUPRO NICKEL ALLOY TUBING

- Coiled tubing that bends & flares easily and never rusts.
- Made of **90%** copper and **10%** nickel alloy.
- OE on many European vehicles.
- DOT approved as replacement for brake, fuel, power steering, and cooling lines.
- This tubing can be used for automotive, farm and industrial application.

J&B #	TUBE SIZE	LENGTH
V38996	3/16	25'
V39003	3/16	50'
V38997	3/16	100'
V38998	1/4	25'
V39004	1/4	50'
V38995	1/4	100'
V38999	5/16	25'
V39002	3/8	25'

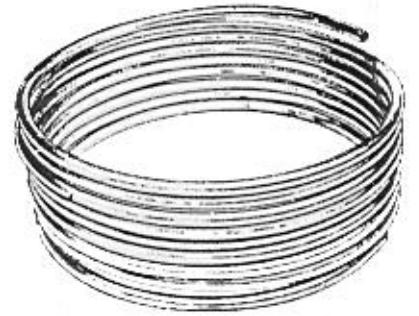

## GREEN ARMORLINE COATED TUBING

- Coiled tubing that bends and flares easily.
- This tubing can be used for automotive, farm and industrial application.

J&B #	TUBE SIZE	LENGTH
V38330	3/16	25'
V38331	3/16	100'
V38332	1/4	25'
V38333	1/4	100'

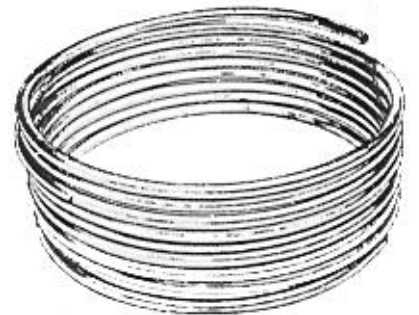



# TUBING TOOLS

---

## PRECISION TUBE CUTTER

- 1/8" TO 1-1/8" precision tube cutter.
- For all copper & aluminum tubing.
- Double roller for superior cutting.

J&B #	QTY
50315	EA



---

## QUICK OPEN FLARING TOOL

- Use on copper, brass & aluminum tubing sizes 3/16" to 5/8" OD.
- Self-Centering yoke of shock proof malleable steel.
- Makes SAE 45 degree flare joints without cracking.
- Hardened super smooth cone.
- Long handle for added leverage.
- Large wing nuts permit easy, positive locking on the tubing.

J&B #	QTY
50320	EA



# COMPRESSION BRASS FITTINGS

---

**Advantages:**

No flaring, soldering or other preparation of tubing necessary to assemble. This economical fitting is readily available in broad selection of styles. Manufactured from CA 360, CA 345, or CA 377 brass rod.

**Specifications:**

Listed with Underwriter's Laboratories for flammable liquid. Compression fittings meet functional requirements of SAE J-512, ASA and ASME.

**Applications:**

Use with copper, brass and aluminum. Not recommended for steel tubing. Manufactured for low and medium pressure tubing connection work where excessive vibration or tube movement is not involved. Use long nut for additional vibration resistance.

**Working Pressure Ranges:**

Temperature and type of tubing used are important factors; however, the following table is a good guide for proper selection. Temperature 73°F:

<b>PSI</b>	<b>TUBE O.D. (in.)</b>	<b>PSI</b>	<b>TUBE O.D. (in.)</b>
400	1/8	200	3/8
400	3/16	200	1/2
300	1/4	150	5/8
300	5/16	100	3/4

**Temperature Ranges:**

From -65° to +250°F

**SLEEVE**



J&B #	TUBE SIZE	QTY
20278	1/8	50
20279	3/16	50
20280	1/4	50
20281	5/16	50
20282	3/8	50
20418	7/16	20
20419	1/2	20
20420	5/8	10
20421	3/4	10

**NUT**



J&B #	TUBE SIZE	QTY
20283	1/8	20
20284	3/16	20
20285	1/4	20
20286	5/16	20
20287	3/8	10
20422	7/16	10
20423	1/2	10
20424	5/8	1
20425	3/4	1

# COMPRESSION BRASS FITTINGS

## MALE CONN



J&B #	TUBE SIZE	PIPE THREAD	QTY
20362	1/8	1/16	10
20296	1/8	1/8	10
20297	3/16	1/8	10
20298	1/4	1/8	10
20299	1/4	1/4	10
20300	5/16	1/8	10
20301	5/16	1/4	10
20303	3/8	1/8	10
20302	3/8	1/4	10
20304	3/8	3/8	5
20427	3/8	1/2	2
20428	7/16	1/4	5
20433	1/2	1/4	5
20429	1/2	3/8	5
20430	1/2	1/2	5
20431	5/8	1/2	1
20432	3/4	1/2	1

## MALE ELBOW

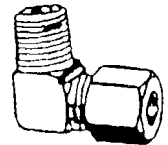

J&B #	TUBE SIZE	PIPE THREAD	QTY
20305	1/8	1/8	10
20306	3/16	1/8	10
20307	1/4	1/8	10
20308	1/4	1/4	10
20309	5/16	1/8	10
20310	5/16	1/4	10
20312	3/8	1/8	5
20311	3/8	1/4	10
20313	3/8	3/8	5
21405	1/2	3/8	5
21406	1/2	1/2	5
21407	5/8	1/2	1
21408	3/4	1/2	1

## FEMALE CONN



J&B #	TUBE SIZE	PIPE THREAD	QTY
21412	1/8	1/8	5
21413	3/16	1/8	5
21414	1/4	1/8	10
21415	5/16	1/8	10
21416	3/8	1/4	5
21417	1/2	3/8	5

## MALE BRANCH TEE



J&B #	TUBE SIZE	PIPE THREAD	QTY
20326	3/16	1/8	5
20327	1/4	1/8	5
20325	1/4	1/4	5
20328	5/16	1/8	5
20329	3/8	1/4	5
21410	1/2	3/8	5

# COMPRESSION BRASS FITTINGS

## SUREGRIP SLEEVE



J&B #	SIZE	QTY
25116	1/8	50
20260	5/32	50

## SUREGRIP NUT



J&B #	SIZE	QTY
20261	1/8	50
20262	5/32	50

## DELRIN SLEEVE



J&B #	SIZE	QTY
25105	1/4	50
25106	5/16	50
25107	3/8	50
25108	1/2	20

## LONG NUT



J&B #	TUBE SIZE	QTY
20288	1/4	5
20289	5/16	5
20290	3/8	5
21418	1/2	5

## UNION ELBOW

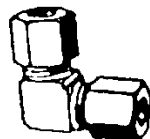

J&B #	TUBE SIZE	QTY
20318	3/16	5
20319	1/4	5
20320	5/16	5
20321	3/8	5
20426	1/2	5

## UNION



J&B #	TUBE SIZE	QTY
20291	1/8	10
20292	3/16	10
20293	1/4	10
20294	5/16	10
20295	3/8	10
21402	1/2	5
21403	5/8	1
21404	3/4	1

## BRASS INSERT

J&B #	SIZE	QTY
25109	1/8	50
25110	3/16	50
25111	1/4	50
25112	5/16	50
25113	3/8	50
25114	1/2	20
25115	5/8	10

## UNION TEE



J&B #	TUBE SIZE	QTY
20315	1/4	5
52763	5/16	5
20317	3/8	5

## BARB FITTING



J&B #	PARKER	TUBE	BAR B	QTY
V52601	6CAHB-5-6	5/16	3/8	5
V52603	6CAHB-6-6	3/8	3/8	5

# COMPRESSION FITTINGS

## COMPRESSION UNION



J&B #	SIZE	QTY
	STEEL TO NYLON	
FM2941	1/4	4
FM2942	5/16	4
FM2943	3/8	4

\* SOLD IN FULL BOXES ONLY

## 360 DEGREE SEAL COMPRESSION UNIONS



J&B #	SIZE	QTY
	STRAIGHT	
FM2856	1/4	2
FM2857	5/16	2
FM2858	3/8	2
FM2859	10mm (Nylon only)	2

\* SOLD IN FULL BOXES ONLY



J&B #	SIZE	QTY
	REDUCER	
FM2841	3/8 to 5/16	4
FM2842	10mm to 3/8 (Nylon only)	4

\* SOLD IN FULL BOXES ONLY



J&B #	SIZE	QTY
	90 DEGREE ELBOW	
FM2846	5/16	2
FM2847	3/8	2

\* SOLD IN FULL BOXES ONLY

# AIR BRAKE FITTINGS

## FOR COPPER TUBING

### Advantages:

Easy to assemble, no flaring required. Extruded from CA 360 or CA 345 brass.

### Specifications:

AB fittings will meet DOT FMVSS571.106 air brake specifications when assembled with 63NTA tube support and J844 nylon tubing.

### Applications:

Use with copper tubing in air brake systems. Bodies (with addition of NTA tube support) are interchangeable with NTA bodies for use with SAE J844 nylon tubing.

### Working Pressure Ranges:

Up to 400 PSI.

### Temperature Ranges:

Fittings will withstand variations from -65° to +250°F.

### NUT



J&B #	TUBE SIZE	STRAIGHT THREAD	QTY
21154	1/4	7/16-24	5
20814	3/8	17/32-24	20
20815	1/2	11/16-20	5
20816	5/8	13/16-18	5
20817	3/4	1-18	5

### SLEEVE

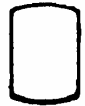

J&B #	TUBE SIZE	QTY
21156	1/4	20
20810	3/8	20
20811	1/2	20
20812	5/8	10
20813	3/4	10

### UNION



J&B #	TUBE SIZE	QTY
21157	1/4	5
20828	3/8	10
20829	1/2	5
20830	5/8	5
20831	3/4	2

### 45° MALE ELB

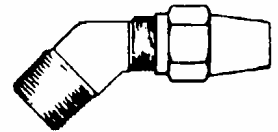

J&B #	TUBE SIZE	PIPE THRD	QTY
21171	3/8	1/4	5
21464	3/8	3/8	5
21465	1/2	3/8	5
21474	5/8	1/2	5

# AIR BRAKE FITTINGS

## FOR COPPER TUBING

### MALE CONN

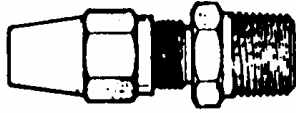

J&B #	TUBE SIZE	PIPE THRD	QTY
21158	1/4	1/8	5
38225	1/4	1/4	10
23009	3/8	1/8	5
38226	3/8	1/4	10
20833	3/8	3/8	5
20836	3/8	1/2	5
20832	1/2	1/4	5
20834	1/2	3/8	5
20837	1/2	1/2	5
20835	5/8	3/8	5
20838	5/8	1/2	5
20839	3/4	1/2	5
20840	3/4	3/4	5

### 90° MALE ELBOW

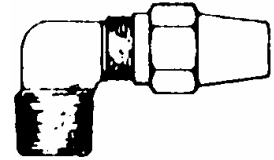

J&B #	TUBE SIZE	PIPE THRD	QTY
21160	1/4	1/8	5
23010	1/4	1/4	5
23011	3/8	1/8	5
21161	3/8	1/4	10
20820	3/8	3/8	5
20823	3/8	1/2	5
20819	1/2	1/4	5
20821	1/2	3/8	5
20824	1/2	1/2	5
20822	5/8	3/8	5
20825	5/8	1/2	5

### UNION TEE

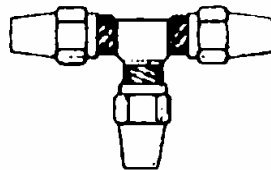

J&B #	TUBE SIZE	QTY
20827	3/8	5
20826	1/2	5

### 90° MALE ELB - LONG

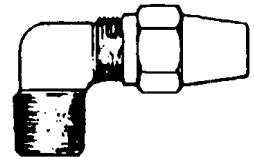

J&B #	TUBE SIZE	PIPE THRD	QTY
20818	3/8	1/4	2

# NYLON (AIR BRAKE) TUBING

## PARFLEX TUBING:

Nylon tubing designed for use in tractor, trailer and other mobile air brake, fuel, instrumentation and air accessory systems. Meets SAE J844 Type A or B and performance requirements as specified in SAE J1131.

- 100% quality controlled - 100% pressure tested.
- Saves weight and labor in comparison with copper tubing.
- Heat and light stabilized.

## TYPE A TUBING

Single wall extruded type 11 nylon tubing.



**Temperature Range:** 40°F to +200°F  
(-40°C to +93°C).

**Maximum Working Pressure:** 150 PSI.

Meets Dot FMVSS 106 (Size 2 not listed in FMVSS 106).

J&B #	PARKER #	TUBE O.D.	MIN. BEND RADIUS	QTY
50502	1120-2A	1/8	3/8	100'
50503	1120-2.5	5/32	1/4	100'
50504	1120-4A	1/4	1	100'
50505	1120-5A	5/16	1-1/4	100'

## TYPE B REINFORCED TUBING

Seamless extruded nylon 11 core reinforced with one open ply of fibrous reinforcement and a protective nylon 11 cover sheath. The outer cover and core are fused to minimize leakage and maximize impact resistance and are always of contrasting colors.



**Temperature Range:** -40°F to +200°F.  
(-40°C to 93°C).

**Maximum Working Pressure:** 150 PSI.

Meets Dot FMVSS 106.

J&B #	PARKER #	TUBE O.D.	MIN. BEND RADIUS	QTY
50506	1120-6B	3/8	1-1/2	100'
50508	1120-8B	1/2	2	50'
50510	1120-10B	5/8	2-1/2	50'
50512	1120-12B	3/4	3	25'

## TUBE CUTTER



J&B #	TYPE	QTY
50500	Tube Cutter	EA
50501	Rep. Blade	EA



# NYLON (AIR BRAKE) TUBING

## COLORED TUBING

### PARFLEX TUBING:

Nylon tubing designed for use in tractor, trailer and other mobile air brake, fuel, instrumentation and air accessory systems. Meets SAE J844 Type A or B and performance requirements as specified in SAE J1131.

- 100% quality controlled - 100% pressure tested.
- Saves weight and labor in comparison with copper tubing.
- Heat and light stabilized.

## TYPE B REINFORCED TUBING

Seamless extruded nylon 11 core reinforced with one open ply of fibrous reinforcement and a protective nylon 11 cover sheath. The outer cover and core are fused to minimize leakage and maximize impact resistance and are always of contrasting colors.

Temperature Range: -40°F to +200°F.  
(-40°C to 93°C).



Maximum Working Pressure: 150 PSI.

Meets Dot FMVSS 106.

J&B #	PARKER #	TUBE O.D.	MIN. BEND RADIUS	COLOR	QTY
50515	1120-6B-YEL	3/8	1-1/2	YELLOW	100'

\* Rolls cannot be broken.

J&B #	PARKER #	TUBE O.D.	MIN. BEND RADIUS	COLOR	QTY
50529	1120-6B-BLK	3/8	1-1/2	BLACK	500'
50531	1120-6B-RED	3/8	1-1/2	RED	500'

\* Rolls cannot be broken



# NYLON TUBING

## BLACK NYLON FUEL LINE TUBING

Not D.O.T. Approved for Airbrakes

- For applications requiring low density, lightweight toughness, flexibility and chemical resistance.
- Suitable for pneumatics, gasoline and diesel fuel.
- UV stabilized.
- Hardness = 78 Rockwell R.
- Vacuum rating: To 28" Hg.



**Temperature Range:**

-60 °F to +200°F  
(-51°C to +93°C).

**Working Pressure:**

4 to 1 Safety Factor

**Compliance:**

J&B #	TUBE O.D.	TUBE I.D.	WALL THICKNESS	WP at 75 F	QTY
32350	1/4"	.170"	.040"	265 PSI	25'
50516	1/4"	.170"	.040"	265 PSI	100'
32351	5/16"	.232"	.040"	220 PSI	25'
50517	5/16"	.232"	.040"	220 PSI	100'
50518	3/8"	.275"	.050"	220 PSI	100'
32352	10 mm	8 mm	1 mm	180 PSI	25'
50523	10 mm	8 mm	1 mm	180 PSI	100'

Not D.O.T. approved  
for airbrakes.  
Meets UL94HB

\*Cannot break rolls.

# NTA BRASS FITTINGS

**NTA Advantages:**

Meets D.O.T. FMVSS 571.106 air brake specifications. Utilizes ribbed sleeve for compression and positive grip. Features built-in stainless steel inserts for extra strength in compression.

**No Special Tools Needed:**

You can assemble tubing to NTA fittings, no need to flare. Machined from CA 360, CA 345 or CA 377 brass.

**Specifications:**

Meets functional requirements of the SAE automotive tube fitting standards: SAE J246 and SAE J1131.

**Applications:**

Use with SAE J844 Type A and B nylon tubing in air brake systems or in cab air controls.

**Working Pressure Ranges:**

Up to 150 PSI.

**Temperature Ranges:**

Fittings will withstand variations from -40° to +200 F

**NUT**



J&B #	TUBE SIZE	PARKER #	QTY
52010	1/4	61NTA-4	25
52012	3/8	61NTA-6	25
52014	1/2	61NTA-8	25
52016	5/8	61NTA-10	25
52018	3/4	61NTA-12	10

**MALE CONN**



J&B #	TUBE SIZE	PIPE THRD	PARKER #	QTY
52049	3/16	1/16	68NTA-3-1	10
52050	1/4	1/8	68NTA-4-2	10
52052	1/4	1/4	68NTA-4-4	10
52054	1/4	3/8	68NTA-4-6	10
52785	3/8	1/8	68NTA-6-2	10
52056	3/8	1/4	68NTA-6-4	10
52058	3/8	3/8	68NTA-6-6	10
52060	3/8	1/2	68NTA-6-8	10
52062	1/2	1/4	68NTA-8-4	10
52064	1/2	3/8	68NTA-8-6	10
52066	1/2	1/2	68NTA-8-8	10
52157	5/8	3/8	68NTA-10-6	5
52068	5/8	1/2	68NTA-10-8	5
52069	3/4	1/2	68NTA-12-8	1
52120	3/4	3/4	68NTA-12-12	1

**FEMALE CONN**



J&B #	TUBE SIZE	PIPE THRD	PARKER #	QTY
52040	1/4	1/8	66NTA-4-2	10
52042	1/4	1/4	66NTA-4-4	10
52788	3/8	1/8	66NTA-6-2	10
52044	3/8	1/4	66NTA-6-4	10
52046	3/8	3/8	66NTA-6-6	10

# NTA BRASS FITTINGS

## SLEEVE



J&B #	TUBE SIZE	PARKER #	QTY
52000	1/4	60NTA-4	100
52002	3/8	60NTA-6	100
52004	1/2	60NTA-8	100
52006	5/8	60NTA-10	50
52008	3/4	60NTA-12	25

## INSERT



J&B #	TUBE SIZE	PARKER #	QTY
52030	1/4	63NTA-4	100
52032	3/8	63NTA-6	100
52034	1/2	63NTA-8	100
52036	5/8	63NTA-10	50
52038	3/4	63NTA-12	25

## UNION



J&B #	TUBE SIZE	PARKER #	QTY
52020	1/4	62NTA-4	10
52022	3/8	62NTA-6	10
52024	1/2	62NTA-8	10
52026	5/8	62NTA-10	5
52786	3/4	62NTA-12	1

## 45° ELBOW



J&B #	TUBE SIZE	PIPE THRD	PARKER #	QTY
52790	1/4	1/8	279NTA-4-2	10
52110	1/4	1/4	279NTA-4-4	10
52112	3/8	1/8	279NTA-6-2	10
52114	3/8	1/4	279NTA-6-4	10
52116	3/8	3/8	279NTA-6-6	10
52792	1/2	1/4	279NTA-8-4	5
52118	1/2	3/8	279NTA-8-6	5
52793	1/2	1/2	279NTA-8-8	5
52158	5/8	3/8	279NTA-10-6	2
52791	5/8	1/2	279NTA-10-8	1
52795	3/4	1/2	279NTA-12-8	1

## MALE ELBOW

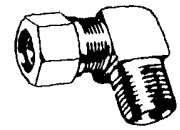

J&B #	TUBE SIZE	PIPE THRD	PARKER #	QTY
52080	1/4	1/8	269NTA-4-2	10
52082	1/4	1/4	269NTA-4-4	10
52083	1/4	3/8	269NTA-4-6	10
52084	3/8	1/8	269NTA-6-2	10
52086	3/8	1/4	269NTA-6-4	10
52088	3/8	3/8	269NTA-6-6	10
52090	3/8	1/2	269NTA-6-8	10
52095	1/2	1/4	269NTA-8-4	10
52092	1/2	3/8	269NTA-8-6	10
52094	1/2	1/2	269NTA-8-8	10
52159	5/8	3/8	269NTA-10-6	5
52096	5/8	1/2	269NTA-10-8	5
52097	3/4	1/2	269NTA-12-8	1

## MALE BRANCH TEE

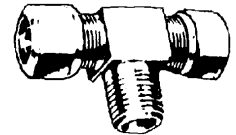

J&B #	TUBE SIZE	PIPE THRD	PARKER #	QTY
52102	1/4	1/8	272NTA-4-2	10
52104	1/4	1/4	272NTA-4-4	10
52106	3/8	1/4	272NTA-6-4	10
52108	3/8	3/8	272NTA-6-6	10
52122	1/2	3/8	272NTA-8-6	5

## MALE RUN TEE

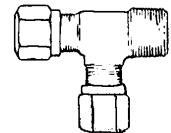

J&B #	TUBE SIZE	PIPE THRD	PARKER #	QTY
42156	3/8	1/4	271NTA-6-4	1
52796	3/8	3/8	271NTA-6-6	1

## UNION TEE

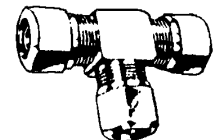

J&B #	TUBE SIZE	PARKER #	QTY
52070	1/4	264NTA-4	5
52072	3/8	264NTA-6	5
52794	1/2	264NTA-8	1

# NTA BRASS FITTINGS

## SLEEVE



J&B #	BASE#	TUBE SIZE	QTY
59031	52000	1/4	100
59010	52002	3/8	100
59011	52004	1/2	100

## MALE ELBOW

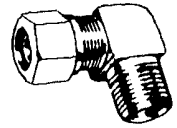

J&B #	BASE#	TUBE SIZE	PIPE THRD	QTY
59035	52080	1/4	1/8	10
59036	52082	1/4	1/4	10
59019	52086	3/8	1/4	10
59020	52088	3/8	3/8	10
59038	52094	1/2	1/2	10

## NUT



J&B #	BASE#	TUBE SIZE	QTY
59032	52010	1/4	25
59009	52012	3/8	25
59033	52014	1/2	25

## 45° ELBOW



J&B #	BASE#	TUBE SIZE	PIPE THRD	QTY
59039	52110	1/4	1/4	10
59021	52114	3/8	1/4	10
59022	52116	3/8	3/8	10
59023	52792	1/2	1/4	5
59024	52118	1/2	3/8	10

## UNION



J&B #	BASE#	TUBE SIZE	QTY
59034	52020	1/4	10
59012	52022	3/8	10
59013	52024	1/2	10

## MALE CONN



J&B #	BASE#	TUBE SIZE	PIPE THRD	QTY
59040	52050	1/4	1/8	10
59041	52052	1/4	1/4	10
59014	52056	3/8	1/4	10
59015	52058	3/8	3/8	10
59016	52060	3/8	1/2	10
59017	52062	1/2	1/4	10
59018	52064	1/2	3/8	10
59042	52066	1/2	1/2	10

## MALE BRANCH TEE

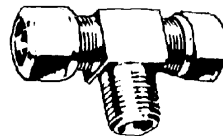

J&B #	BASE#	TUBE SIZE	PIPE THRD	QTY
59044	52108	3/8	3/8	10
59028	52122	1/2	3/8	5

## UNION TEE

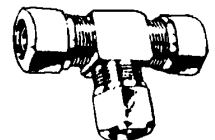

J&B #	BASE#	TUBE SIZE	QTY
59043	52070	1/4	5

# PRESTOLOK FITTINGS

## Advantages:

- Compact one piece brass fitting for use with polyethylene, nylon or soft metal tubing.
- This fitting is specially designed for low pressure circuits where fast assembly, disassembly and reassembly is important.
- No special tools are needed for assembly; just insert the tubing into the fitting until it bottoms.
- Radial claws on the metal grab ring grip the tubing securely to provide retention.
- Prestolok can be assembled and disassembled repeatedly without impairing its ability to seal.

## Applications:

Prestolok is designed to conduct air, water, oil and inert gases. Prestolok is ideal for use in pneumatic instrumentation circuits and many industrial applications. All applications should be carefully tested through the range of conditions which may be encountered prior to use.

## Working Pressure and Temperature Ranges:

Zero to 150°F at up to 285 psi. Vacuum applications are dependent upon temperature and type of tubing being used.

## MALE CONNECTOR



J&B #	TUBE SIZE	PIPE SIZE	QTY
54523	5/32	1/16	10
52762	1/8	1/16	10
54520	1/8	1/8	10
54522	5/32	1/8	10
54574	1/4	1/8	10
54575	1/4	1/4	10
54521	5/16	1/4	10
54576	3/8	1/8	10

## MALE ELBOW SWIVEL 90°



J&B #	TUBE SIZE	PIPE SIZE	QTY
54540	1/8	1/8	10
54542	5/32	1/8	10
54577	1/4	1/8	10
54578	1/4	1/4	10
54579	3/8	1/8	10

## UNION



J&B #	TUBE SIZE	QTY
54500	1/8	10
54502	5/32	10
54580	1/4	10
54503	5/16	10

## UNION TEE

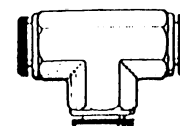

J&B #	TUBE SIZE	QTY
54560	1/8	10
54562	5/32	10
54582	1/4	10

# PRESTOMATIC FITTINGS

## AIR BRAKE PUSH-IN FITTINGS

### Advantages:

- Sizes 5/32" and above meet D.O.T. FMVSS 571.106 air brake performance specifications
- No special tools are needed to assemble. Just bottom the tubing in the fitting body for a positive seal.
- Stainless steel tube support in sizes 1/4" and above assures maximum flow and performance requirements of SAE J1131.
- Lubricated o-ring seal (Buna N) insures a quick, easy and positive seal.
- Innovative collet design insures positive grip on tubing.
- Release button offers quick and easy disconnections.

### Applications:

- Designed for all D.O.T. truck and trailer applications.
- Consult the factory with any questions regarding special product applications.

### Technical Data:

- Working pressure from 27in. Hg vacuum to 250 psi.
- Working temperature from -40°F to +200°F.

---

### ASSEMBLY INSTRUCTIONS:

1. Cut Parker Parflex J844 tubing squarely with Parker tube cutter PTC-001. Be certain the port or mating part is clean and free of debris.
2. Insert tubing into fitting until it bottoms. Pull on tubing to verify it is properly retained in the fitting.
3. To disassemble, simply hold release button against the body and remove tubing.
4. To reassemble, lubricate leading end of the tubing with light oil or petroleum jelly.

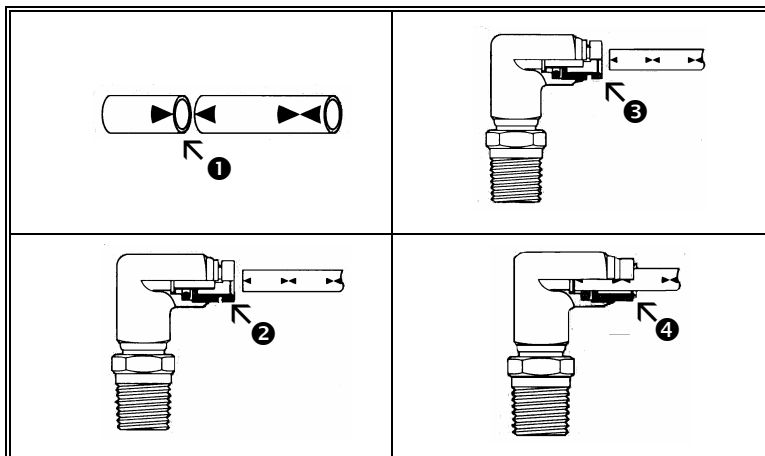

# PRESTOMATIC FITTINGS

## AIR BRAKE PUSH-IN FITTINGS

**MALE  
CONNECTOR**

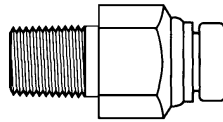

J&B #	TUBE SIZE	PIPE SIZE	QTY
54523	5/32	1/16	10
54524	1/4	1/8	10
54526	1/4	1/4	10
54532	3/8	1/4	10
54533	3/8	3/8	10
54536	1/2	3/8	5

**MALE ELBOW  
SWIVEL 90°**

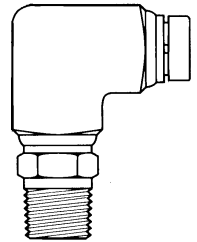

J&B #	TUBE SIZE	PIPE SIZE	QTY
54543	1/4	1/8	5
54544	1/4	1/4	5
54550	3/8	1/4	5
54551	3/8	3/8	5

**UNION**



J&B #	TUBE SIZE	QTY
54504	1/4	10
54506	3/8	10
54508	1/2	5

**UNION TEE**

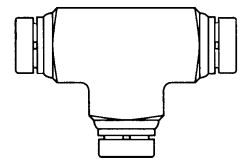

J&B #	TUBE SIZE	QTY
54564	1/4	5
54566	3/8	5

**MALE BRANCH  
TEE SWIVEL**

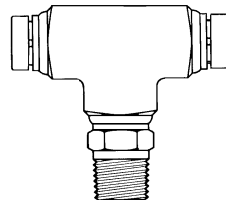

J&B #	TUBE SIZE	PIPE SIZE	QTY
54572	1/4	1/8	5



# PRESS TO CONNECT FITTINGS

## UNION



J&B #	TUBE SIZE	QTY
54800	1/8	10
54801	5/32	10

## MALE CONNECTOR



J&B #	TUBE SIZE	PIPE SIZE	QTY
54813	1/8	1/16	10
54814	1/8	1/8	10
54815	5/32	10/32	10
54816	5/32	1/8	10

## UNION TEE

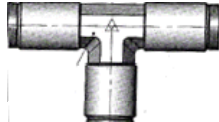

J&B #	TUBE SIZE	QTY
54802	1/8	5
54803	5/32	5

## MALE BRANCH TEE

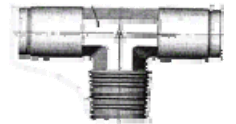

J&B #	TUBE SIZE	PIPE SIZE	QTY
54807	5/32	1/8	5

## MALE BRANCH TEE SWIVEL

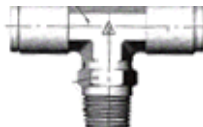

J&B #	TUBE SIZE	PIPE SIZE	QTY
54809	1/8	1/8	2

## UNION ELBOW 90

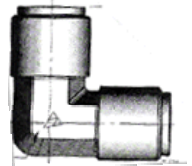

J&B #	TUBE SIZE	QTY
54804	1/8	5
54805	5/32	5

## MALE ELBOW 90

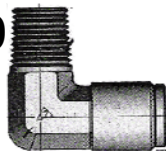

J&B #	TUBE SIZE	PIPE SIZE	QTY
54821	5/32	1/8	10

## MALE ELBOW SWIVEL 90

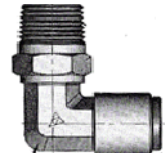

J&B #	TUBE SIZE	PIPE SIZE	QTY
54822	1/8	1/8	10
54823	5/32	1/8	10

# PRESS TO CONNECT FITTINGS

## DOT APPROVED

### UNION

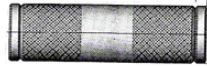

J&B #	TUBE SIZE	QTY
54819	3/16	5
54825	1/4	5
54826	3/8	5
54827	1/2	2
54828	5/8	2
54891	3/4	2

### MALE CONNECTOR

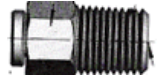

J&B #	TUBE SIZE	PIPE SIZE	QTY
54834	1/4	1/8	10
54835	1/4	1/4	10
54837	3/8	1/8	10
54838	3/8	1/4	10
54839	3/8	3/8	10
54841	1/2	1/4	5
54842	1/2	3/8	5
54843	1/2	1/2	5
54833	5/8	3/8	2
54845	5/8	1/2	2
54893	3/4	1/2	2

### BULKHEAD UNION

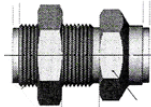

J&B #	TUBE SIZE	QTY
54880	1/4	2
54881	3/8	2
54882	1/2	2

### MALE BRANCH TEE SWIVEL

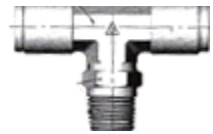

J&B #	TUBE SIZE	PIPE SIZE	QTY
54872	1/4	1/8	2
54873	1/4	1/4	2
54875	3/8	1/4	2
54879	3/8	3/8	2
54876	1/2	1/4	2
54877	1/2	3/8	2

### GLADHAND BULKHEAD CONNECTOR

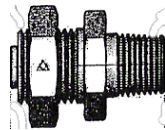

J&B #	TUBE SIZE	PIPE SIZE	QTY
54884	1/2	1/2	1

### UNION TEE

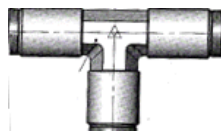

J&B #	TUBE SIZE	QTY
54830	1/4	2
54831	3/8	2
54832	1/2	2
54878	5/8	2

### MALE RUN TEE SWIVEL 90

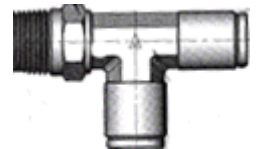

J&B #	TUBE SIZE	PIPE SIZE	QTY
54869	3/8	1/4	2
54870	3/8	3/8	2

# PRESS TO CONNECT FITTINGS

## DOT APPROVED

### MALE ELBOW SWIVEL 90

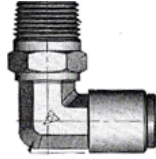

J&B #	TUBE SIZE	PIPE SIZE	QTY
54846	1/4	1/8	5
54847	1/4	1/4	5
54849	3/8	1/8	2
54850	3/8	1/4	2
54851	3/8	3/8	2
54852	3/8	1/2	2
54854	1/2	3/8	2
54856	1/2	1/2	2
54836	5/8	3/8	2
54858	5/8	1/2	2
54895	3/4	1/2	2

### MALE ELBOW 45

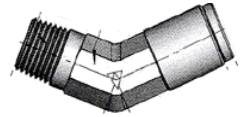

J&B #	TUBE SIZE	PIPE SIZE	QTY
54859	1/4	1/8	5
54860	1/4	1/4	5
54862	3/8	1/4	5
54863	3/8	3/8	5
54866	1/2	3/8	2
54896	1/2	1/2	2
54885	5/8	1/2	2
54897	3/4	1/2	2

### UNION ELBOW 90

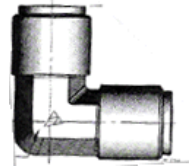

J&B #	TUBE SIZE	QTY
54810	1/4	2
54811	3/8	2
54812	1/2	2

### UNION TEE

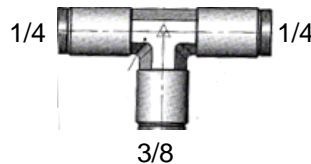

J&B #	TUBE SIZE	QTY
V54890	1/4 x 1/4 x 3/8	10

# JOHN GUEST FITTINGS

## THE PI RANGE OF INCH-SIZE FITTINGS

- Manufactured in gray acetyl copolymer with food grade nitride o-ring, making them Especially suitable for applications involving foodstuff and potable liquids.
- They are equally suitable for air and inert gasses and can therefore be used on CO2 lines, pneumatic applications and vacuum.

### MALE CONNECTOR



J&B #	TUBE SIZE	NPTF THREAD	QTY
PI010821S	1/4	1/8	10
PI010822S	1/4	1/4	10
PI010823S	1/4	3/8	10
PI011221S	3/8	1/8	10
PI011222S	3/8	1/4	10
PI011223S	3/8	3/8	10

### STEM ADAPTER



J&B #	TUBE SIZE	NPTF THREAD	QTY
PI050821S	1/4	1/8	10
PI050822S	1/4	1/4	10
PI051222S	3/8	1/4	10
PI051223S	3/8	3/8	10

### UNION



J&B #	TUBE SIZE	QTY
PI0408S	1/4	10
PI0412S	3/8	10

### SWIVEL ELBOW



J&B #	TUBE SIZE	NPTF THREAD	QTY
PI090822S	1/4	1/4	10
PI091222S	3/8	1/4	10

### UNION ELBOW



J&B #	TUBE SIZE	QTY
PI0308S	1/4	10
PI0312S	3/8	10

### UNION TEE



J&B #	TUBE SIZE	QTY
PI0208S	1/4	10
PI0212S	3/8	10

# AIR BRAKE HOSE

## LOW PRESSURE

AIR BRAKE HOSE CAN BE USED WITH THE AIR BRAKE FITTINGS ON PAGE 679.



### Application:

Air Brake Hose Lines

- Designed for conveying air in truck and industrial trailer brake systems.
- This hose is certified to meet SAE J1402A and D.O.T. FMVSS 106 requirements.
- Temperature resistance -40F to +200F. Cover = EPDM, RMA Class C.
- The synthetic oil resistant tube & cover with a four spiral polyester reinforcement makes it virtually kink-proof and keeps it flexible even in extreme temperatures.

### Construction:

- *Outer Cover* - Synthetic compound; resistant to oil, grease, abrasion, ozone and sunlight.
- *Reinforcement* - Duct piles of synthetic fiber.
- *Inner Tube* - Synthetic compound, resistant to gasoline, grease and other petroleum products, common hydraulic fluid, air and water.

J&B #	HOSE O.D.	HOSE I.D.	QTY
* 38684	3/4"	3/8"	50 FT.
* 38685	7/8"	1/2"	50 FT.

\* No broken boxes

# REUSABLE HOSE ENDS-AIR BRAKE

## AIR BRAKE HOSE END KITS

- Meets the requirements of DOT 106 and SAE J1402
- Swivel Ends reduce residual torque in hose for longer life – No need to disconnect both ends to service the brake system.
- Components in contact with the air are made of corrosion resistant brass and nylon to improve air system life.



Kit

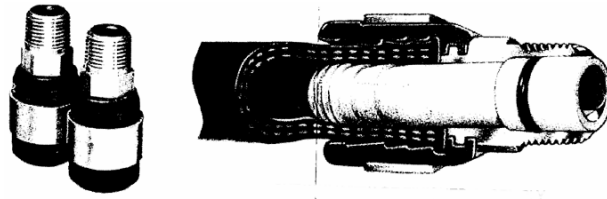

J&B #	DESCRIPTION	HOSE SIZE	PIPE THREAD	QTY
31402	Two End Fittings Per Kit	3/8	3/8	1
31403	Two End Fittings Per Kit	3/8	1/2	1

\* Kits not available for 1/2 I.D. hose.

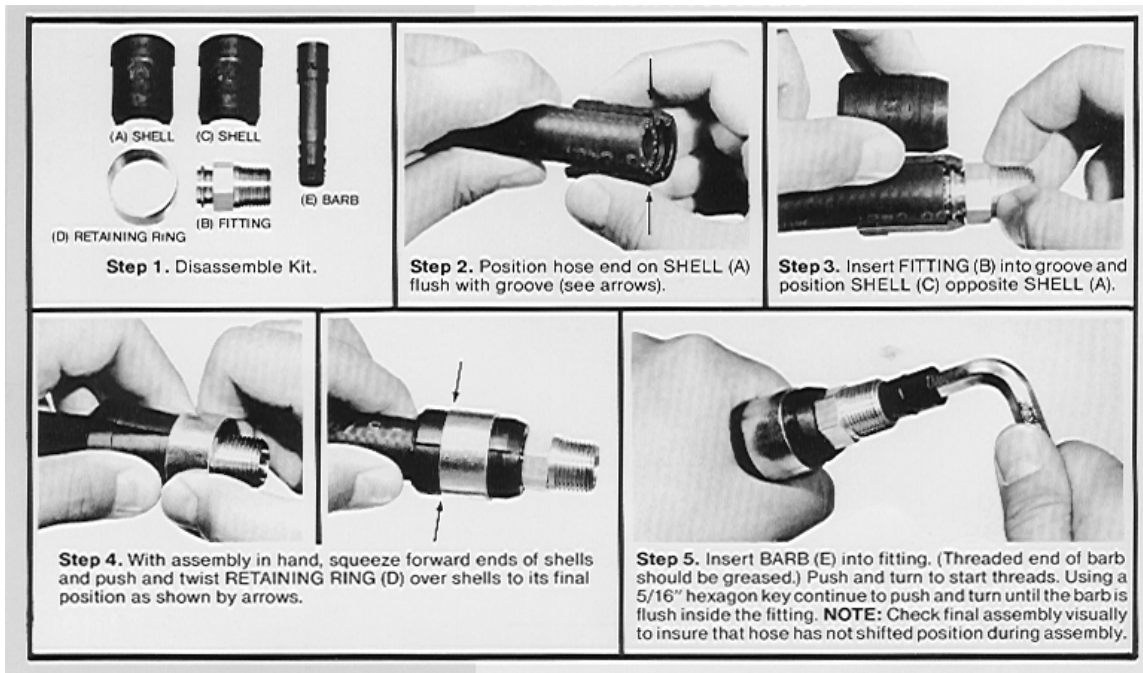

# REUSABLE HOSE ENDS-AIR BRAKE

## Advantages:

Easy to assemble and disassemble. Extruded from CA360 or CA345 brass. Sleeves are made from CA274 brass.

## Specifications:

Air brake hose ends will meet D.O.T. FMVSS571.106 standards when used with SAE J1402 air brake hose.

## Working Pressure Ranges:

Up to 125 PSI.

## Applications:

Air brake hose connections.

## Temperature Ranges:

-40°F to +120°F.

## CONNECTOR



J&B #	HOSE SIZE	PIPE THRD	QTY
20842	3/8	1/4	5
21517	3/8	3/8	5
**60048	3/8	3/8	5
20843	3/8	1/2	5
20854	1/2	3/8	5
20855	1/2	1/2	5

\*\* 60048 is not Parker Brand

## SLEEVE

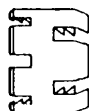

J&B #	HOSE SIZE	QTY
20841	3/8	10
20850	1/2	10

\* SLEEVES SHOULD NEVER BE REUSED

## HOSE UNION

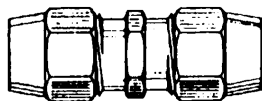

J&B #	HOSE SIZE	QTY
20809	3/8	5
22197	1/2	2

## CONNECTOR W/SPRING GUARD



J&B #	HOSE SIZE	PIPE THRD	QTY
20845	3/8	1/4	6
21498	3/8	3/8	6
20846	3/8	1/2	6
40871	1/2	3/8	6

## NUT



J&B #	HOSE SIZE	QTY
20844	3/8	5
20852	1/2	5

## INSERT

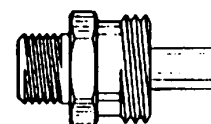

J&B #	HOSE SIZE	PIPE THRD	QTY
21482	3/8	1/4	5
21483	3/8	3/8	5
21530	3/8	1/2	5

## ADAPTER BODY



J&B #	SPECIAL THREAD	MALE PIPE	QTY
20847	3/4-20	3/8	5
20848	7/8-20	3/8	5

# SAE 45° FLARE BRASS FITTINGS

---

## Advantages:

This economical fitting resists mechanical pullout. Can be assembled and disassembled repeatedly. Manufactured from CA 360, CA 345 or CA 377 brass.

## Specifications:

Listed with Underwriter's Laboratories for flammable liquid, marine, refrigeration and gas applications. Meets functional requirements of SAE, ASA, ASME and MS (Military Standards).

## Applications:

Use with copper, brass, aluminum and welded steel hydraulic tubing that can be flared. Manufactured especially for hard-to-hold liquids and gases.

## Working Pressure Ranges:

Temperature and type of tubing used are important factors. However, the following table is a good guide for proper selection. Temperature 73°F with copper tubing:

PSI	TUBE O.D. (in.)	PSI	TUBE O.D. (in.)
2800	1/8	1000	3/8
1900	3/16	750	1/2
1400	1/4	650	5/8
1200	5/16	550	3/4

## Temperature Ranges:

From -65° to +250°F.

## Vibration:

Short nut may be used when vibration is minimal. The long nut offers additional vibration capacity.

## LONG NUT

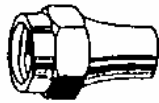

J&B #	TUBE SIZE	QTY
20330	3/16	10
20331	1/4	10
20332	5/16	10
20333	3/8	10
21452	1/2	5
21453	5/8	1

## SHORT NUT

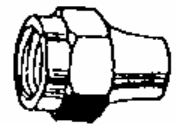

J&B #	TUBE SIZE	QTY
20334	1/8	10
20335	3/16	10
20336	1/4	10
20337	5/16	5
20338	3/8	5
21454	1/2	5
21455	5/8	5
21456	3/4	5



# SAE 45° FLARE BRASS FITTINGS

## MALE CONN



J&B #	TUBE SIZE	PIPE THREAD	QTY
20344	1/8	1/8	10
20345	3/16	1/8	10
20346	1/4	1/8	10
20347	1/4	1/4	10
20348	5/16	1/8	10
20349	5/16	1/4	10
20351	3/8	1/8	5
20350	3/8	1/4	10
20352	3/8	3/8	5
22091	3/8	1/2	5
22092	1/2	1/4	5
22093	1/2	3/8	5
22094	1/2	1/2	5
22095	5/8	3/8	2
22096	5/8	1/2	2
22099	5/8	3/4	2
22097	3/4	1/2	1
22098	3/4	3/4	1

## MALE ELBOW

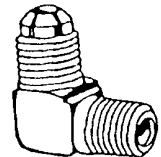

J&B #	TUBE SIZE	PIPE THREAD	QTY
20354	3/16	1/8	5
20355	1/4	1/8	10
20356	1/4	1/4	5
20357	5/16	1/8	10
20358	5/16	1/4	10
20360	3/8	1/8	5
20359	3/8	1/4	10
20361	3/8	3/8	5
22100	3/8	1/2	5
22101	1/2	1/4	5
22102	1/2	3/8	5
22103	1/2	1/2	5
22104	5/8	3/8	2
22088	5/8	1/2	2
22089	3/4	1/2	1
22090	3/4	3/4	1

## FEMALE CONN



J&B #	TUBE SIZE	PIPE THREAD	QTY
22105	3/16	1/8	5
22106	1/4	1/4	5
22107	5/16	1/8	5
22110	3/8	1/8	5
22108	3/8	1/4	5
22109	1/2	3/8	5

## SAE UNION



J&B #	TUBE SIZE	QTY
20339	1/8	5
20340	3/16	5
20341	1/4	5
20342	5/16	5
20343	3/8	5
22085	1/2	2
22086	5/8	2
22087	3/4	1

# SAE 45° FLARE BRASS FITTINGS

## FLARED SEAL PLUG

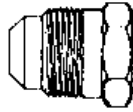

J&B #	TUBE SIZE	QTY
52651	1/4	5
52652	5/16	5
52653	3/8	5
52654	1/2	5
52655	5/8	2

## 45° ELBOW



J&B #	TUBE SIZE	PIPE THREAD	QTY
52642	1/4	1/8	5
52643	1/4	1/4	5
52644	5/16	1/4	5
52645	3/8	1/4	5
52648	3/8	3/8	5
52646	1/2	3/8	5
52647	5/8	3/8	5
52649	5/8	1/2	2

## CAP NUT

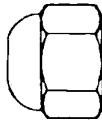

J&B #	TUBE SIZE	QTY
52656	3/16	5
52657	1/4	5
52658	5/16	5
52659	3/8	5
52660	1/2	5
52661	5/8	2
52664	3/4	2

## MALE BRANCH TEE



J&B #	TUBE SIZE	PIPE THREAD	QTY
20373	3/16	1/8	5
20374	1/4	1/8	5
20375	5/16	1/8	5
20376	3/8	1/4	5

# INVERTED FLARE BRASS FITTINGS

---

**Advantages:**

Built to resist mechanical pullout. This economical fitting can be assembled and disassembled repeatedly. Manufactured from CA 360 or CA 345 brass.

**Specifications:**

Listed with Underwriter's Laboratories for flammable liquid and gas. Meets functional requirements of SAE, J512, ASA, ASME and MS (Military Standards).

**Applications:**

Use with copper, brass, aluminum and welded steel hydraulic tubing that can be flared. Manufactured especially for hard-to-hold liquids and gases.

**Working Pressure Ranges:**

Temperature and type of tubing used are important factors. However, the following table is a good guide for proper selection. Temperature 73°F with copper tubing:

PSI	TUBE O.D. (in.)	TUBE WALL (in.)
2800	1/8	.030
1900	3/16	.030
1400	1/4	.030
1200	5/16	.032

PSI	TUBE O.D. (in.)	TUBE WALL (in.)
1000	3/8	.032
750	1/2	.032
650	5/8	.035
550	3/4	.035

**Temperature Ranges:**

From -65° to +250°F.

**MALE CONN**



J&B #	TUBE SIZE	PIPE THRD	QTY
20382	1/8	1/8	10
20383	3/16	1/8	10
20384	1/4	1/8	10
21423	1/4	1/4	10
20385	5/16	1/8	10
21424	5/16	1/4	10
20386	3/8	1/8	5
20387	3/8	1/4	10
20388	3/8	3/8	5
21425	1/2	3/8	5
21426	5/8	1/2	1

**MALE ELBOW**

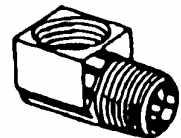

J&B #	TUBE SIZE	PIPE THRD	QTY
20389	1/8	1/8	5
20390	3/16	1/8	10
20391	1/4	1/8	10
20393	1/4	1/4	5
20392	5/16	1/8	10
20394	5/16	1/4	10
20395	3/8	1/8	5
20396	3/8	1/4	10
20397	3/8	3/8	5
21432	1/2	3/8	5

# INVERTED FLARE BRASS FITTINGS

## STEEL TUBE NUT



J&B #	TUBE SIZE	THREAD	QTY
20377	1/8		20
20378	3/16	3/8-24	20
42377	3/16	3/8-24	10
<b>*(42377 IS VIOLET &amp; HAS A 7/16" HEX)*</b>			
20379	1/4	7/16-24	20
20380	5/16	1/2-20	20
20381	3/8	5/8-18	10
21420	1/2	3/4-18	10
21421	5/8		10

## 45° ELBOW



J&B #	TUBE SIZE	PIPE THRD	QTY
20403	3/16	1/8	5
20404	1/4	1/8	10
20405	5/16	1/8	10
20407	3/8	1/4	5
21431	1/2	3/8	5

## LONG STEEL TUBE NUT



J&B #	TUBE SIZE	THREAD	QTY
42378	3/16	3/8-24	10
42379	1/4	7/16-24	10

## BRASS TUBE NUT

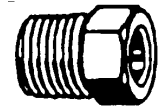

J&B #	TUBE SIZE	QTY
20445	3/16	10
20446	1/4	10

## UNION



J&B #	TUBE SIZE	QTY
20398	1/8	5
20399	3/16	10
20400	1/4	10
20401	5/16	10
20402	3/8	5
21422	1/2	5

## PLUG STEEL INVERTED FLARE



J&B #	TUBE SIZE	QTY
42345	3/16	10
42346	1/4	10
42347	5/16	10
42348	3/8	5

# INVERTED FLARE BRASS FITTINGS

---

## METRIC CONVERSION ADAPTERS

J&B #	FEMALE TUBE SIZE	MALE THREAD	STYLE	QTY
40380	3/16	M10 x 1.0	BUBBLE	5
40381	3/16	M10 x 1.0	INVERT	5
40386	3/16	M11 x 1.5	BUBBLE	1
40387	3/16	M12 x 1.0	BUBBLE	1
40388	3/16	M13 x 1.5	BUBBLE	1

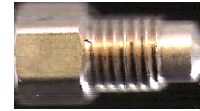

---

## CONVERSION INVERTED FLARE ADAPTERS (MASTER CYLINDER)

J&B #	FEMALE INV. FLARE TUBE	MALE INV. FLARE TUBE	MALE THREAD	QTY
40370	3/16	1/4	7/16-24	5
40371	3/16	5/16	1/2-20	5
40375	3/16	3/8	9/16-18	5
40372	1/4	3/16	3/8-24	5
40374	1/4	5/16	1/2-20	5
40378	1/4	3/8	9/16-18	5

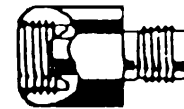

---

## HI-FLOW / HEAVY WALL FLARE UNIONS

J&B #	TUBE SIZE	THREAD	STYLE	QTY
40384	3/16	M10 X 1.00	BUBBLE	1
40385	3/16	M10 X 1.00	FLARE	1

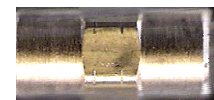

# INVERTED FLARE BRASS FITTINGS

## METRIC & IMPERIAL BUBBLE FLARE TUBE NUTS



40382



42369



42362



42363



42364

J&B #	FMSI	TUBE SIZE	THREAD	COLOR	TYPE	QTY
40382	3028	3/16	M10 x 1.0	OLIVE	EUROPEAN / DOMESTIC	5
42369	3420	3/16	M10 x 1.0	GOLD	FORD	5
42362	3040	3/16	M11 x 1.5	ORANGE/GREY	GM / FORD	5
42363	3041	3/16	M12 x 1.0	BLUE	GM / FORD	5
42364	3042	3/16	M13 x 1.5	GREEN	GM / FORD	5

## METRIC INVERTED FLARE TUBE NUTS



40383



42358



42359



40389



42360

J&B #	FMSI	TUBE SIZE	THREAD	COLOR	TYPE	QTY
40383	3043	3/16	M10 x 1.0	BLUE	JAPANESE	5
42358	3411	3/16	M10 x 1.0	GOLD	JAPANESE 12MM HEX LONG	5
42359	3413	1/4	M12 x 1.0	OLIVE	FORD & IMPORTS	5
40389	3417	3/16	M10 x 1.0	BLUE	TOYOTA,GM - LONG NUT	5
42360	3449	3/16	M10 x 1.0	SILVER		5

## FORD NUT

- Ford Gas Line Nut with comp sleeve soldered to nut.

J&B #	TUBE SIZE	QTY
20411	1/4	10

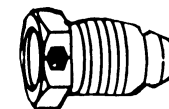

# INVERTED FLARE BRASS FITTINGS

## OVERSIZE STEEL TUBE NUTS



42350



42351



42352



42353



42354

J&B #	FMSI	TUBE SIZE	THREAD	COLOR	QTY
42350	3022	3/16	7/16-24	RED	5
42351	3023	3/16	1/2-20	GREEN	5
42352	3024	3/16	9/16-18	OLIVE / GOLD	5
42353	3025	1/4	9/16-18	BLUE	5
42354	3026	1/4	1/2-20	SILVER	5

## FUEL LINE TUBE NUTS



42374



42375

J&B #	FMSI	TUBE SIZE	THREAD	COLOR	TYPE	QTY
42374	3008	3/8	M16 x 1.5	OLIVE	GM	5
42375	3009	5/16	M14 x 1.5	OLIVE	GM	5

## FLARE NUT



J&B #	SURR	TUBE SIZE	THREAD	QTY
42376	BR1650	1/4	1/2-20	10

# DOUBLE COMPRESSION BRASS FITTINGS

---

## COMPRESSION NUT



J&B #	TUBE SIZE	QTY
21438	1/8	10
20408	3/16	10
20409	1/4	10
20410	5/16	10
21439	3/8	5

## MALE CONNECTOR

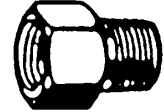

J&B #	TUBE SIZE	PIPE THRD	QTY
21447	1/8	1/8	10
21448	3/16	1/8	10
21451	3/8	1/4	10

## MALE ELBOW

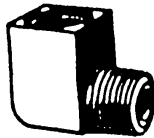

J&B #	TUBE SIZE	PIPE THRD	QTY
21441	1/8	1/8	5
21443	1/4	1/8	10
21444	5/16	1/8	10
21445	3/8	1/4	5



# BRAKE LINES

## HYDRAULIC STEEL BRAKE LINES

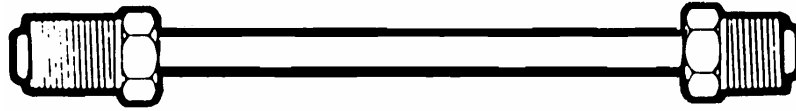

- Have been developed and manufactured to meet or exceed the following automotive and SAE specifications: SAE-527b, SAE J-533b, M.S. 1806 and GM 123.
- These lines resist corrosion, vibration, fatigue and shocks from impact.
- They provide increased protection and pressures greater than the most forceful braking applications.
- These brake lines are made by double wrapping a copper coated steel strip to form a double walled tube. Then the copper/steel tube is furnace-fused into one continuous, seamless line.
- Corrosion protection is provided by a lead/tin compound (ternecoat) coating.

LENGTH	3/16 DIA.	1/4 DIA.	5/16 DIA.	3/8 DIA.
8"	40450	40460	40470	
12"	40451	40461	40471	
20"	40452	40462	40472	
30"	40453	40463	40473	
40"	40454	40464	40474	
51"	40455	40465	40475	
60"	40456	40466	40476	40479
72"	40457	40467		

\* Must buy minimum of 10 assorted pieces to ship UPS.

## ASSORTMENT AND RACK

J&B #	DESCRIPTION
38441	Brake Line Rack for 3/16 & 1/4 lines
2098	Brake Line Assortment - Rack plus one each of all 3/16 and 1/4 lines

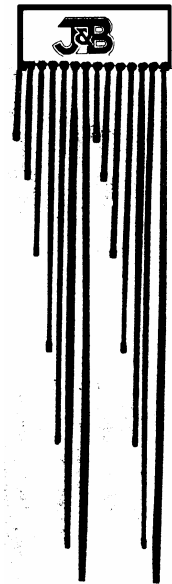

# BRAKE LINES

## METRIC BRAKE LINES

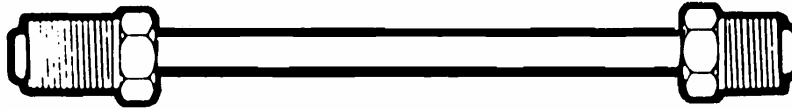

EUROPEAN / DOMESTIC (BUBBLE FLARE)				
J&B #	LENGTH	TUBE SIZE	THREAD	QTY
40522	8"	3/16	10MM	1
40523	12"	3/16	10MM	1
40524	20"	3/16	10MM	1
40525	30"	3/16	10MM	1
40526	40"	3/16	10MM	1
40527	51"	3/16	10MM	1
40528	60"	3/16	10MM	1

JAPANESE (DOUBLE FLARE)				
J&B #	LENGTH	TUBE SIZE	THREAD	QTY
40530	8"	3/16	10MM	1
40531	12"	3/16	10MM	1
40532	20"	3/16	10MM	1
40533	30"	3/16	10MM	1
40534	40"	3/16	10MM	1
40535	51"	3/16	10MM	1
40536	60"	3/16	10MM	1

\* Must buy minimum of 10 assorted pieces to ship UPS.

## ASSORTMENT AND RACK

J&B #	DESCRIPTION
38442	Brake Line Rack - Metric
2099	Brake Line Assortment - Rack plus one each of all metric sizes

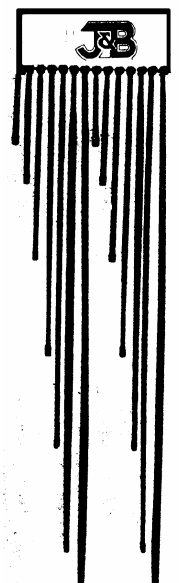

# BALL VALVES



## Advantages:

- Parker's CA377 forged brass body and bronze body ball valves provides extended service life and resists failure caused by severe temperature applications.
- Optimum flow design assures maximum system efficiency.
- Highly inert teflon seats and seals allow ease of opening and closing, plus the advantage of resistance to chemical corrosion.
- Parker also provides a blow-out proof stem and a specially designed handle enabling easier turning leverage.

## Applications: (Brass)

Fuel line shutoff for gasoline and diesel powered over the highway, off highway, and construction equipment vehicles.

Water and air service lines on capital equipment and plant design plumbing that requires total shutoff ability.

## Applications: (Bronze)

Water and air service lines on capital equipment and plant design plumbing that requires total shutoff ability.

## Operating Instructions:

Quarter turn is "ON" or "OFF". (Provides positive stop action for maximum flow and full shutoff.)

## Working Pressure:

600 PSI W.O.G. 150 PSI Saturated Steam

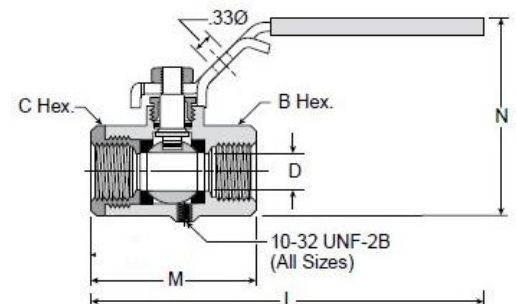

J&B #	PARKER #	PIPE THRD	C & B HEX	L	M	N	FLOW DIA. D	QTY
38518	V500P-4	1/4	15/16	4.75	2.03	2.23	.375	EA
38519	V500P-6	3/8	15/16	4.75	2.03	2.23	.375	EA
38520	V500P-8	1/2	1-1/16	4.85	2.20	2.41	.500	EA
38521	V500P-12	3/4	1-3/8	5.80	3.00	3.14	.690	EA
38522	V500P-16	1	1-5/8	6.15	3.32	3.14	.875	EA
54600	V500P-20	1-1/4	1.90	6.13	3.50	3.72	1.22	EA
54601	V500P-24	1-1/2	2.19	8.04	3.85	4.37	1.50	EA
54602	V500P-32	2	2.78	8.34	4.45	5.03	1.97	EA

- \* 1/4 - 1" BRASS BODY
- \* 1-1/4 - 2" BRONZE BODY

# BALL VALVES

---



**Advantages:**

- Proline brand.
- Forged brass.
- Lead free.
- -20 to 300 fahrenheit temperature range.

**Operating Instructions:**

Quarter turn is "ON" or "OFF". (Provides positive stop action for maximum flow and full shutoff.)

**Working Pressure:**

600 PSI W.O.G. 150 PSI Saturated Steam

---

J&B #	PIPE THRD	QTY
60051	1/4	EA
60052	3/8	EA
60053	1/2	EA
60054	3/4	EA

# TRUCK VALVES

---

**Advantages:**

Parker truck valves have metal-to-metal seats with fine-thread screwdown. This enables positive sealing up to the capacity of the valve.

**Working Pressure Ranges:**

Valves are designed to withstand up to 150 PSI working pressure.

---

**TRUCK VALVE**

(Hose to Male Pipe)

J&B #	TUBE SIZE	PIPE THRD	QTY
52150	3/8	3/8	EA
52152	5/8	3/8	EA

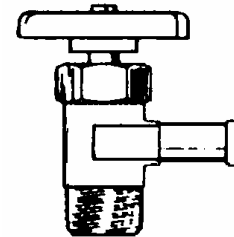

**TRUCK VALVE**

(Hose to Male Pipe)

J&B #	TUBE SIZE	PIPE THRD	QTY
52154	5/8	1/2	EA
52156	3/4	1/2	EA

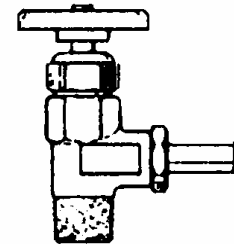

**TRUCK VALVE**

(Female Pipe to Male Pipe)

J&B #	MALE PIPE	FEMALE PIPE	QTY
52638	1/2	1/2	EA

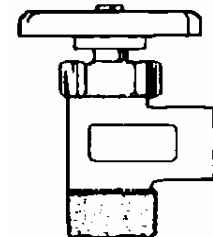

**TRUCK VALVE**

(Flare to Male Pipe)

J&B #	TUBE SIZE	PIPE THRD	QTY
52640	5/8	1/2	EA

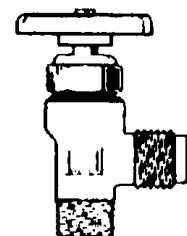

# VALVES

---

**Applications:**

Manufactured for use with low pressure air, water, gas and certain other fluids.

**Working Pressure Ranges:**

System temperature and the type of tubing used should be considered. Ground plug shutoffs are designed to withstand 30 PSI working pressure. Drain cocks are designed to withstand 150 PSI working pressure, except where noted.

---

**GROUND PLUG SHUTOFF COCK**

(30 PSI)

J&B #	FEMALE PIPE	MALE PIPE	QTY
21489	1/4	1/4	5

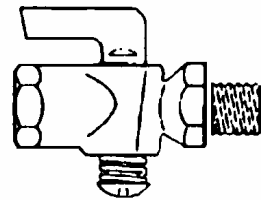

**GROUND PLUG SHUTOFF COCK**

(30 PSI)

J&B #	TUBE SIZE	PIPE THRD	QTY
52798	1/4	1/4	2

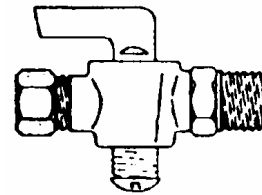

**GROUND PLUG SHUTOFF COCK**

(30 PSI)

J&B #	FEMALE PIPE	QTY
52622	1/8	5
52624	1/4	5
52626	3/8	5

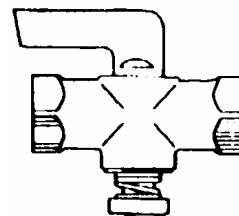

# VALVES

**DRAIN COCK**  
(30 PSI)

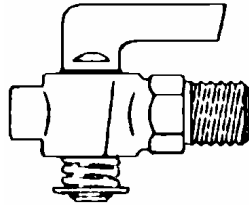

J&B #	PIPE THREAD	QTY
20435	1/8	5
20436	1/4	5
52628	3/8	5

**DRAIN COCK**  
(150 PSI)

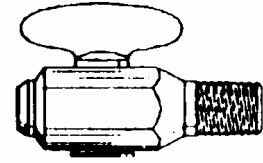

J&B #	PIPE THREAD	QTY
21172	1/4	5

**DRAIN COCK**

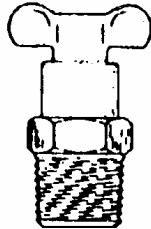

J&B #	PIPE THREAD	QTY
52630	1/8	5
52632	1/4	5
52634	3/8	5

**EXTERNAL SEAL  
DRAIN COCK**

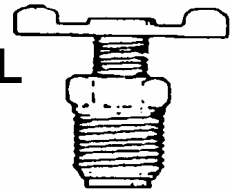

J&B #	PIPE THREAD	QTY
20437	1/8	5
20438	1/4	10
52636	3/8	5

**EXTERNAL SEAL  
DRAIN COCK**

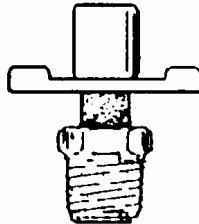

J&B #	PIPE THREAD	QTY
20439	1/4	5

# VALVES

## TANK VALVES

- Used on compressed air tanks and pneumatic devices.
- Permits inflation, deflation and pressure testing similar to tire valve treatment.
- Standard valve stem thread plus short brass cap.

J&B #	THREAD	LENGTH	QTY
52800	1/8" NPT	3/4	5
52801	1/4" NPT	3/4	5



## AIR TANK DRAIN VALVE

- Self-sealing with remote 5 foot cable.

J&B #	PIPE THREAD	QTY
39280	1/4	EA

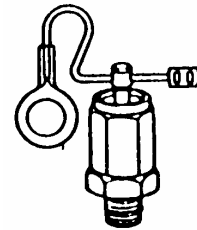

## HOOD RELEASE AND CHOKE WIRE STOP

J&B #	QTY
52802	10

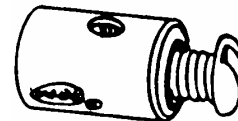



# BrakeCoil™

## Tractor to Trailer Coiled Nylon Air-Brake Connections

You get it all with Parker BrakeCoil - designed for just about any tractor/trailer air-brake application you will need for trouble free service on your rig.

- Heavy-duty cadmium plated spring guards that are rust resistant for added protection.
- More coils offer you maximum working lengths.
- No need for pogo sticks or spring hangers.
- Color coding gives you mistake-free hook-ups: blue for service, red for emergency.
- Temperature range: -40°F to +200°F.

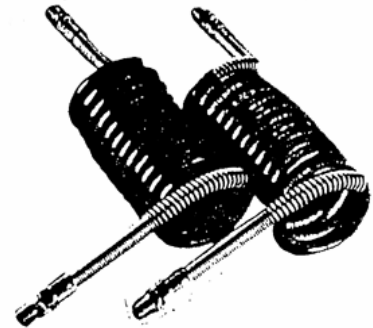

BrakeCoil kits are supplied complete - Parker preassembled. Everything needed including spring guards and male pipe end NTA fittings ready to install. No cutting or assembly necessary. Just attach the gladhand to either end. A kit consists of both a red and blue tube assembly.

J&B #	PARKER #	TUBE O.D.	VALVE TAIL LENGTH	MALE ENDS		WORKING LENGTH	APPLICATION
				VALVE	GLADHAND		
52570	731516	1/2	12"	1/2	1/2	15'	Tractor to Trailer

## GLADHAND COUPLINGS

- Die cast aluminum body.
- Conforms to SAE J318.
- Connects to 1/2" pipe.



J&B #	QTY
21669	EA

## GLADHAND SEAL

- Air coupling seals all trucks using air brakes.



J&B #	QTY
21476	25

# CROSS REFERENCE

## BRASS FITTINGS

WEATHER-HEAD #	J&B #	DESCRIPTION	OUR PAGE #
100x3	20445	brass tube nut-3/16	688
100x4	20446	brass tube nut-1/4	688
105x10	21421	steel tube nut-5/8	688
105x2	20377	steel tube nut-1/8	688
105x3	20378	steel tube nut-3/16	688
105x4	20379	steel tube nut-1/4	688
105x5	20380	steel tube nut-5/16	688
105x6	20381	steel tube nut-3/8	688
105x8	21420	steel tube nut-1/2	688
1110x10	21455	short nut-5/8	682
1110x12	21456	short nut-3/4	682
1110x2	20334	short nut-1/8	682
1110x3	20335	short nut-3/16	682
1110x4	20336	short nut-1/4	682
1110x5	20337	short nut-5/16	682
1110x6	20338	short nut-3/8	682
1110x8	21454	short nut-1/2	682
135	20437	drain cock-1/8	698
1421	39280	drain valve-1/4	699
1424	52630	drain cock-1/8	698
1425	52632	drain cock-1/4	698
1426	52634	drain cock-3/8	698
145	20438	drain cock-1/4	698
1460x10	52006	sleeve-5/8	671
1460x12	52008	sleeve-3/4	671
1460x4	52000	sleeve-1/4	671
1460x6	52002	sleeve-3/8	671
1460x8	52004	sleeve-1/2	671
1461x10	52016	nut-5/8	670
1461x12	52018	nut-3/4	670
1461x4	52010	nut-1/4	670
1461x6	52012	nut-3/8	670
1461x8	52014	nut-1/2	670
1462x10	52026	union-5/8	671
1462x12	52786	union-3/4	671
1462x4	52020	union-1/4	671
1462x6	52022	union-3/8	671
1462x8	52024	union-1/2	671
1464x4	52070	union tee-1/4	671
1464x6	52072	union tee-3/8	671
1464x8	52794	union tee-1/2	671
1466x4	52040	fe conn-1/4 x 1/8	670
1466x6	52044	fe conn-3/8 x 1/4	670
1466x6x2	52788	fe conn-3/8 x 1/8	670
1466x6x6	52046	fe conn-3/8 x 3/8	670
1468x10	52068	ml conn-5/8 x 1/2	670
1468x4	52050	ml conn-1/4 x 1/8	670
1468x4x4	52052	ml conn-1/4 x 1/4	670
1468x4x6	52054	ml conn-1/4 x 3/8	670
1468x6	52056	ml conn-3/8 x 1/4	670
1468x6x2	52785	ml conn-3/8 x 1/8	670
1468x6x6	52058	ml conn-3/8 x 3/8	670
1468x6x8	52060	ml conn-3/8 x 1/2	670
1468x8	52064	ml conn-1/2 x 3/8	670

WEATHER-HEAD #	J&B #	DESCRIPTION	OUR PAGE #
1468x8x4	52062	ml conn-1/2 x 1/4	670
1468x8x8	52066	ml conn-1/2 x 1/2	670
1469x10	52096	ml elb-5/8 x 1/2	671
1469x4	52080	ml elb-1/4 x 1/8	671
1469x4x4	52082	ml elb-1/4 x 1/4	671
1469x6	52086	ml elb-3/8 x 1/4	671
1469x6x2	52084	ml elb-3/8 x 1/8	671
1469x6x6	52088	ml elb-3/8 x 3/8	671
1469x6x8	52090	ml elb-3/8 x 1/2	671
1469x8	52092	ml elb-1/2 x 3/8	671
1469x8x4	52095	ml elb-1/2 x 1/4	671
1469x8x8	52094	ml elb-1/2 x 1/2	671
1471x6x6x6	52796	ml run t-3/8 x 3/8	671
1472x4	52102	ml br t-1/4 x 1/8	671
1472x6	52106	ml br t-3/8 x 1/4	671
1472x6x4x4	52104	ml br t-1/4 x 1/4	671
1472x6x6x6	52108	ml br t-3/8 x 3/8	671
1480x4	52790	45° elb-1/4 x 1/8	671
1480x6	52114	45° elb-3/8 x 1/4	671
1480x6x2	52112	45° elb-3/8 x 1/8	671
1480x6x6	52116	45° elb-3/8 x 3/8	671
1480x8	52118	45° elb-1/2 x 3/8	671
1480x8x4	52792	45° elb-1/2 x 1/4	671
1480x8x8	52793	45° elb-1/2 x 1/2	671
1484x10	52036	insert-5/8	671
1484x12	52038	insert-3/4	671
1484x4	52030	insert-1/4	671
1484x6	52032	insert-3/8	671
1484x8	52034	insert-1/2	671
1611x10	21419	long nut-5/8	660
1611x4	20288	long nut-1/4	660
1611x5	20289	long nut-5/16	660
1611x6	20290	long nut-3/8	660
1611x8	21418	long nut-1/2	660
200x2	20382	ml con-1/8 x 1/8	687
200x3	20383	ml con-3/16 x 1/8	687
200x4	20384	ml con-1/4 x 1/8	687
200x4x4	21423	ml con-1/4 x 1/4	687
200x5	20385	ml con-5/16 x 1/8	687
200x5x4	21424	ml con-5/16 x 1/4	687
200x6	20387	ml con-3/8 x 1/4	687
200x6x2	20386	ml con-3/8 x 1/8	687
200x6x6	20388	ml con-3/8 x 3/8	687
200x8	21425	ml con-1/2 x 3/8	687
202x10	21426	ml con-5/8 x 1/2	687
2030x10	25115	brass insert-5/8	660
2030x2	25109	brass insert-1/8	660
2030x3	25110	brass insert-3/16	660
2030x4	25111	brass insert-1/4	660
2030x5	25112	brass insert-5/16	660
2030x6	25113	brass insert-3/8	660
2030x8	25114	brass insert-1/2	660
270	52636	drain cock-3/8	698
300x2	20398	union-1/8	688

# CROSS REFERENCE

## BRASS FITTINGS

WEATHER-HEAD #	J&B #	DESCRIPTION	OUR PAGE #
300x3	20399	union-3/16	688
300x4	20400	union-1/4	688
300x5	20401	union-5/16	688
300x6	20402	union-3/8	688
302x8	21422	union-1/2	688
3129x2	52766	cap-1/8	651
3129x4	20322	cap-1/4	651
3129x6	20323	cap-3/8	651
3129x8	20324	cap-1/2	651
3150x2	23018	slotted plug-1/8	651
3151x2	23014	sq hd plug-1/8	651
3151x4	23015	sq hd plug-1/4	651
3151x6	23016	sq hd plug-3/8	651
3151x8	23017	sq hd plug-1/2	651
3152x12	52765	hx hd plug-3/4	651
3152x2	22321	hx hd plug-1/8	651
3152x4	20440	hx hd plug-1/4	651
3152x6	23012	hx hd plug-3/8	651
3152x8	23013	hx hd plug-1/2	651
3200x2	52665	adapt-1/8 x 1/8	652
3200x4	52667	adapt-1/4 x 1/4	652
3200x4x2	52666	adapt-1/4 x 1/8	652
3200x6	52669	adapt-3/8 x 3/8	652
3200x6x4	52668	adapt-3/8 x 1/4	652
3200x8	52671	adapt-1/2 x 1/2	652
3200x8x4	52672	adapt-1/2 x 1/4	652
3200x8x6	52670	adapt-1/2 x 3/8	652
3220x12x6	23023	bush-3/4 x 3/8	651
3220x12x8	23024	bush-3/4 x 1/2	651
3220x4x2	20412	bush-1/4 x 1/8	651
3220x6x2	20413	bush-3/8 x 1/8	651
3220x6x4	20414	bush-3/8 x 1/4	651
3220x8x2	23020	bush-1/2 x 1/8	651
3220x8x4	23021	bush-1/2 x 1/4	651
3220x8x6	23022	bush-1/2 x 3/8	651
3300x2	23025	coupling-1/8	653
3300x4	23026	coupling-1/4	653
3300x4x2	23029	reducer-1/4 x 1/8	653
3300x6	23027	coupling-3/8	653
3300x6x2	23030	reducer-3/8 x 1/8	653
3300x6x4	23031	reducer-3/8 x 1/4	653
3300x8	23028	coupling-1/2	653
3300x8x6	23032	reducer-1/2 x 3/8	653
3325x12	23007	hx nipple-3/4	652
3325x2	23033	hx nipple-1/8	652
3325x4	23034	hx nipple-1/4	652
3325x6	23035	hx nipple-3/8	652
3325x8	23008	hx nipple-1/2	652
3326x2	20415	cl nipple-1/8	652
3326x4	20416	cl nipple-1/4	652
3326x6	20417	cl nipple-3/8	652
3326x8	23036	cl nipple-1/2	652
3327x2	23037	lg nip-1/8 x 1-1/2	652
3327x4	23038	lg nip-1/4 x 1-1/2	652

WEATHER-HEAD #	J&B #	DESCRIPTION	OUR PAGE #
3328x2	23039	lg nip-1/8 x 2	652
3328x4	23040	lg nip-1/4 x 2	652
3328x6	20365	lg nip-3/8 x 2	652
3329x6	20366	lg nip-3/8 x 2-1/2	652
3329x8	20369	lg nip-1/2 x 2-1/2	652
3350x2	23041	45° str elb-1/8	653
3350x4	23042	45° str elb-1/4	653
3350x6	23043	45° str elb-3/8	653
3350x8	23044	45° str elb-1/2	653
3400x2	23045	90° str elb-1/8	653
3400x4	23046	90° str elb-1/4	653
3400x6	23047	90° str elb-3/8	653
3400x8	23048	90° str elb-1/2	653
3500x2	23049	90° elb-1/8	653
3500x4	23050	90° elb-1/4	653
3500x6	23051	90° elb-3/8	653
3500x8	23052	90° elb-1/2	653
352x3	20403	45° elb-3/16 x 1/8	688
352x4	20404	45° elb-1/4 x 1/8	688
352x5	20405	45° elb-5/16 x 1/8	688
352x5x4	20406	45° elb-5/16 x 1/4	688
352x6	20407	45° elb-3/8 x 1/4	688
352x8	21431	45° elb-1/2 x 3/8	688
3600x2	52680	ml br tee-1/8	653
3600x4	52681	ml br tee-1/4	653
3600x6	52682	ml br tee-3/8	653
3700x2	23053	tee-1/8	653
3700x4	23054	tee-1/4	653
3700x6	23055	tee-3/8	653
3700x8	23056	tee-1/2	653
3750x2	23057	street tee-1/8	653
3750x4	23058	street tee-1/4	653
3750x6	52684	street tee-3/8	653
3750x8	52685	street tee-1/2	653
3950x2	52675	cross-1/8	652
3950x4	52676	cross-1/4	652
3950x6	52677	cross-3/8	652
400x2	20389	ml elb-1/8 x 1/8	687
400x3	20390	ml elb-3/16 x 1/8	687
400x4	20391	ml elb-1/4 x 1/8	687
400x4x4	20393	ml elb-1/4 x 1/4	687
400x5	20392	ml elb-5/16 x 1/8	687
400x5x4	20394	ml elb-5/16 x 1/4	687
400x6	20396	ml elb-3/8 x 1/4	687
400x6x2	20395	ml elb-3/8 x 1/8	687
400x6x6	20397	ml elb-3/8 x 3/8	687
400x8	21432	ml elb-1/2 x 3/8	687
41x10	21453	long nut-5/8	682
41x3	20330	long nut-3/16	682
41x4	20331	long nut-1/4	682
41x5	20332	long nut-5/16	682
41x6	20333	long nut-3/8	682
41x8	21452	long nut-1/2	682
42x10	22086	sae union-5/8	683



# CROSS REFERENCE

## BRASS FITTINGS

WEATHER-HEAD #	J&B #	DESCRIPTION	OUR PAGE #
42x12	22087	sae union-3/4	683
42x2	20339	sae union-1/8	683
42x3	20340	sae union-3/16	683
42x4	20341	sae union-1/4	683
42x5	20342	sae union-5/16	683
42x6	20343	sae union-3/8	683
42x8	22085	sae union-1/2	683
45x3	20373	ml br t-3/16 x 1/8	684
45x4	20374	ml br t-1/4 x 1/8	684
45x5	20375	ml br t-5/16 x 1/8	684
45x6	20376	ml br t-3/8 x 1/4	684
46x3	22105	fe conn-3/16 x 1/8	683
46x4x4	22106	fe conn-1/4 x 1/4	683
46x5	22107	fe conn-5/16 x 1/8	683
46x6	22108	fe conn-3/8 x 1/4	683
46x8	22109	fe conn-1/2 x 3/8	683
48x10	22096	ml con-5/8 x 1/2	683
48x10x6	22095	ml con-5/8 x 3/8	683
48x12	22097	ml con-3/4 x 1/2	683
48x12x12	22098	ml con-3/4 x 3/4	683
48x2	20344	ml con-1/8 x 1/8	683
48x3	20345	ml con-3/16 x 1/8	683
48x4	20346	ml con-1/4 x 1/8	683
48x4x4	20347	ml con-1/4 x 1/4	683
48x5	20348	ml con-5/16 x 1/8	683
48x5x4	20349	ml con-5/16 x 1/4	683
48x6	20350	ml con-3/8 x 1/4	683
48x6x2	20351	ml con-3/8 x 1/8	683
48x6x6	20352	ml con-3/8 x 3/8	683
48x6x8	22091	ml con-3/8 x 1/2	683
48x8	22093	ml con-1/2 x 3/8	683
48x8x4	22092	ml con-1/2 x 1/4	683
48x8x8	22094	ml con-1/2 x 1/2	683
49x10	22088	ml elb-5/8 x 1/2	683
49x10x6	22104	ml elb-5/8 x 3/8	683
49x12	22089	ml elb-3/4 x 1/2	683
49x12x12	22090	ml elb-3/4 x 3/4	683
49x3	20354	ml elb-3/16 x 1/8	683
49x4	20355	ml elb-1/4 x 1/8	683
49x4x4	20356	ml elb-1/4 x 1/4	683
49x5	20357	ml elb-5/16 x 1/8	683
49x5x4	20358	ml elb-5/16 x 1/4	683
49x6	20359	ml elb-3/8 x 1/4	683
49x6x2	20360	ml elb-3/8 x 1/8	683
49x6x6	20361	ml elb-3/8 x 3/8	683
49x6x8	22100	ml elb-3/8 x 1/2	683
49x8	22102	ml elb-1/2 x 3/8	683
49x8x4	22101	ml elb-1/2 x 1/4	683
49x8x8	22103	ml elb-1/2 x 1/2	683
54x4	52642	45° elb-1/4 x 1/8	684
54x6	52645	45° elb-3/8 x 1/4	684
54x8	52646	45° elb-1/2 x 3/8	684
55x8	52764	union elb-1/2	684
60x10	20420	sleeve-5/8	658

WEATHER-HEAD #	J&B #	DESCRIPTION	OUR PAGE #
60x12	20421	sleeve-3/4	685
60x2	20278	sleeve-1/8	658
60x3	20279	sleeve-3/16	658
60x4	20280	sleeve-1/4	658
60x5	20281	sleeve-5/16	658
60x6	20282	sleeve-3/8	658
60x7	20418	sleeve-7/16	658
60x8	20419	sleeve-1/2	658
6100x2	21438	comp nut-1/8	690
6100x3	20408	comp nut-3/16	690
6100x4	20409	comp nut-1/4	690
6100x5	20410	comp nut-5/16	690
6100x6	21439	comp nut-3/8	690
61x10	20424	nut-5/8	658
61x12	20425	nut-3/4	658
61x2	20283	nut-1/8	658
61x3	20284	nut-3/16	658
61x4	20285	nut-1/4	658
61x5	20286	nut-5/16	658
61x6	20287	nut-3/8	658
61x7	20422	nut-7/16	658
61x8	20423	nut-1/2	658
6200x2	21447	ml con-1/8 x 1/8	690
6200x3	21448	ml con-3/16 x 1/8	690
6200x4	21449	ml con-1/4 x 1/8	690
6200x5	21450	ml con-5/16 x 1/8	690
6200x6	21451	ml con-3/8 x 1/4	690
62x10	21403	union-5/8	660
62x12	21404	union-3/4	660
62x2	20291	union-1/8	660
62x3	20292	union-3/16	660
62x4	20293	union-1/4	660
62x5	20294	union-5/16	660
62x6	20295	union-3/8	660
62x8	21402	union-1/2	660
6400x2	21441	ml elb-1/8 x 1/8	690
6400x3	21442	ml elb-3/16 x 1/8	690
6400x4	21443	ml elb-1/4 x 1/8	690
6400x5	21444	ml elb-5/16 x 1/8	690
6400x6	21445	ml elb-3/8 x 1/4	690
64x4	20315	union tee-1/4	660
64x5	52763	union tee-5/16	660
64x6	20317	union tee-3/8	660
65x3	20318	union elb-3/16	660
65x4	20319	union elb-1/4	660
65x5	20320	union elb-5/16	660
65x6	20321	union elb-3/8	660
65x8	20426	union elb-1/2	660
66x2	21412	fe con1/8 x 1/8-	659
66x3	21413	fe con-3/16 x 1/8	659
66x4	21414	fe con-1/4 x 1/8	659
66x5	21415	fe con-5/16 x 1/8	659
66x6	21416	fe con-3/8 x 1/4	659
66x8	21417	fe con-1/2 x 3/8	659

# CROSS REFERENCE

## BRASS FITTINGS

WEATHER-HEAD #	J&B #	DESCRIPTION	OUR PAGE #
6788	20439	drain cock-1/4	698
6804	52622	shutoff cock-1/8	697
6809	52624	shutoff cock-1/4	697
6829	21489	shutoff cock-1/4	697
6891	20435	drain cock-1/8	698
6892	20436	drain cock-1/4	698
6893	52628	drain cock-3/8	698
68x10	20431	ml conn-5/8 x 1/2	659
68x12	20432	ml conn-3/4 x 1/2	659
68x2	20296	ml conn-1/8 x 1/8	659
68x2x1	20362	ml conn-1/8 x 1/16	659
68x3	20297	ml conn-3/16 x 1/8	659
68x4	20298	ml conn-1/4 x 1/8	659
68x4x4	20299	ml conn-1/4 x 1/4	659
68x5	20300	ml conn-5/16 x 1/8	659
68x5x4	20301	ml conn-5/16 x 1/4	659
68x6	20302	ml conn-3/8 x 1/4	659
68x6x2	20303	ml conn-3/8 x 1/8	659
68x6x6	20304	ml conn-3/8 x 3/8	659
68x6x8	20427	ml conn-3/8 x 1/2	659
68x7	20428	ml conn-7/16 x 1/4	659
68x8	20429	ml conn-1/2 x 3/8	659
68x8x4	20433	ml con-1/2 x 1/4	659
68x8x8	20430	ml con-1/2 x 1/2	659
69x10	21407	ml elb-5/8 x 1/2	659
69x12	21408	ml elb-3/4 x 1/2	659
69x2	20305	ml elb-1/8 x 1/8	659
69x3	20306	ml elb-3/16 x 1/8	659
69x4	20307	ml elb-1/4 x 1/8	659
69x4x4	20308	ml elb-1/4 x 1/4	659
69x5	20309	ml elb-5/16 x 1/8	659
69x5x4	20310	ml elb-5/16 x 1/4	659
69x6	20311	ml elb-3/8 x 1/4	659
69x6x2	20312	ml elb-3/8 x 1/8	659
69x6x6	20313	ml elb-3/8 x 3/8	659
69x8	21405	ml elb-1/2 x 3/8	659
69x8x8	21406	ml elb-1/2 x 1/2	659
72x3	20326	ml tee-3/16 x 1/8	659
72x4	20327	ml tee-1/4 x 1/8	659
72x4x4x4	20325	ml tee-1/4 x 1/4	659
72x5	20328	ml tee-5/16 x 1/8	659
72x6	20329	ml tee-3/8 x 1/4	659
72x8	21410	ml tee-1/2 x 3/8	659
A664	52798	shutoff cock-1/4	697
W00360	20814	nut-3/8 x 17/32-24	662
W00361	20810	sleeve-3/8	662
W00455	21154	nut-1/4 x 7/16-24	662
W00457	21156	sleeve-1/4	662
W03610	20841	sleeve-3/8	679
W03624	20844	nut-3/8	679
W03754	20811	sleeve-1/2	662
W03755	20815	nut-1/2 x 11/16-20	662
W03896	20817	nut-3/4 x 1-18	662
W03897	20813	sleeve-3/4	662
W05053	38226	ml conn-3/8 x 1/4	663

WEATHER-HEAD #	J&B #	DESCRIPTION	OUR PAGE #
W05102	21161	90°ml elb-3/8 x 1/4	663
W05106	20827	union tee-3/8	663
W05127	21158	ml con-1/4 x 1/8	663
W05134	20828	union-3/8	662
W05183	38225	ml con-1/4 x 1/4	663
W05509	23009	ml con-3/8 x 1/8	663
W05514	21157	union-1/4	662
W05522	23011	90°ml elb-3/8 x 1/8	663
W05539	21160	90°ml elb-1/4 x 1/8	663
W05824	20833	ml con-3/8 x 3/8	663
W05829	20820	90°ml elb-3/8 x 3/8	663
W10612	20812	sleeve-5/8	662
W10613	20816	nut-5/8 x 13/16-18	662
W15310	21172	drain cock-1/4	698
W15535	20846	connector-3/8 x 1/2	679
W15536	20845	connector-3/8 x 1/4	679
W15539	20843	connector-3/8 x 1/2	679
W15540	20842	connector-3/8 x 1/4	679
W15709	20821	90°ml elb-1/2 x 3/8	663
W15710	20829	union-1/2	662
W15712	20826	union tee-1/2	663
W15762	20840	ml con-3/4 x 3/4	663
W15992	21530	insert-3/8 x 1/2	679
W15993	21482	insert-3/8 x 1/4	679
W16310	20824	90°ml elb-1/2 x 1/2	663
W16523	20831	union-3/4	662
W16678	20809	hose union-3/8	679
W16684	20838	ml con-5/8 x 1/2	663
W16685	20835	ml con-5/8 x 3/8	663
W17525	20834	ml con-1/2 x 3/8	663
W17621	20839	ml con-3/4 x 1/2	663
W17690	20832	ml con-1/2 x 1/4	663
W17691	20837	ml con-1/2 x 1/2	663
W17709	38515	bulk hd coup-3/8	652
W20291	21464	45°ml elb-3/8 x 3/8	662
W20292	21465	45°ml elb-1/2 x 3/8	662
W20475	20819	90°ml elb-1/2 x 1/4	663
W20722	21171	45°ml elb-3/8 x 1/4	662
W21825	20825	90°ml elb-5/8 x 1/2	663
W21826	20830	union-5/8	662
W21993	20822	90°ml elb-5/8 x 3/8	663
W22062	20823	90°ml elb-3/8 x 1/2	663
W22063	20836	ml con-3/8 x 1/2	663
W22065	21474	45°ml elb-5/8 x 1/2	662
W22858	20818	90°ml elb-3/8 x 1/4	663
W23907	21498	connector-3/8 x 3/8	679
W24318	23010	90°ml elb-1/4 x 1/4	663
W24887	21517	connector-3/8 x 3/8	679
W33470	21483	insert-3/8 x 3/8	679
W33801	20850	sleeve-1/2	679
W33802	20852	nut-1/2	679
W33883	20854	connector-1/2 x 3/8	679
W33884	20855	connector-1/2 x 1/2	679
W75150	21669	gladhand couplings	701
WO5465	38510	bulk hd coup-1/4	652

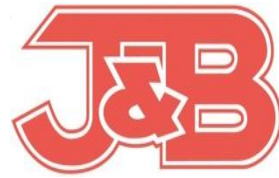













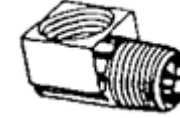

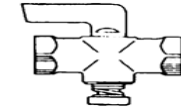



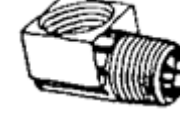





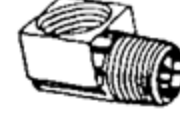
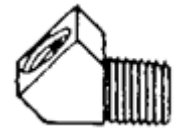

# J&B Fleet - Industrial Supply

22428 Harrisburg-Westville Rd. Alliance, Ohio 44601 Phone: (330) 821-6342 Fax: (330) 821-0411

[www.jbfleet.com](http://www.jbfleet.com)

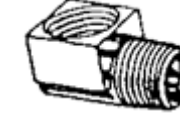
PART # 2282

## BRASS PIPE FITTINGS

 <b>23013</b> 1 1/2" HEX HD PLUG 2	 <b>23022</b> 2 1/2 x 3/8 BUSHING 2	 <b>23008</b> 3 1/2 HEX NIPPLE 2	 <b>23048</b> 4 1/2 90° ST ELBOW 2	 <b>23044</b> 5 1/2 45° ST ELBOW 2	 <b>23028</b> 6 1/2" COUPLING 2	 <b>52624</b> 7 1/4" PLUG SHUTOFF VALVE 1	 <b>52668</b> 8 3/8 x 1/4 ADAPTER 2
 <b>23012</b> 9 3/8" HEX HD PLUG 3	 <b>23021</b> 10 1/2 x 1/4 BUSHING 3	 <b>23035</b> 11 3/8 HEX NIPPLE 3	 <b>23047</b> 12 3/8 90° ST ELBOW 2	 <b>23043</b> 13 3/8 45° ST ELBOW 2	 <b>23027</b> 14 3/8" COUPLING 2	 <b>23032</b> 15 1/2 x 3/8 REDUCER COUPLING 2	 <b>52667</b> 16 1/4 x 1/4 ADAPTER 3
 <b>20440</b> 17 1/4" HEX HD PLUG 3	 <b>20414</b> 18 3/8 x 1/4 BUSHING 5	 <b>23034</b> 19 1/4 HEX NIPPLE 3	 <b>23046</b> 20 1/4 90° ST ELBOW 3	 <b>23042</b> 21 1/4 45° ST ELBOW 3	 <b>23026</b> 22 1/4" COUPLING 3	 <b>23031</b> 23 3/8 x 1/4 REDUCER COUPLING 2	 <b>52666</b> 24 1/4 x 1/8 ADAPTER 3
 <b>22321</b> 25 1/8" HEX HD PLUG 3	 <b>20412</b> 26 1/4 x 1/8 BUSHING 5	 <b>23033</b> 27 1/8 HEX NIPPLE 3	 <b>23045</b> 28 1/8 90° ST ELBOW 3	 <b>23041</b> 29 1/8 45° ST ELBOW 3	 <b>23025</b> 30 1/8" COUPLING 3	 <b>23029</b> 31 1/4 x 1/8 REDUCER COUPLING 2	 <b>52665</b> 32 1/8 x 1/8 ADAPTER 3

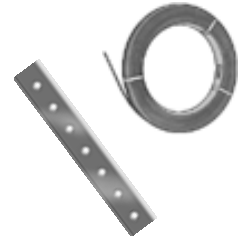





























# J&B Fleet - Industrial Supply

22428 Harrisburg-Westville Rd. Alliance, Ohio 44601 Phone: (330) 821-6342 Fax: (330) 821-0411

[www.jbfleet.com](http://www.jbfleet.com)

PART # 2023

## BRASS PIPE FITTINGS

<p><b>23033</b> <sup>1</sup></p>  <p><b>1/8P HEX NIPPLE</b></p> <p><sup>2</sup></p>	<p><b>23034</b> <sup>2</sup></p>  <p><b>1/4P HEX NIPPLE</b></p> <p><sup>2</sup></p>	<p><b>23035</b> <sup>3</sup></p>  <p><b>3/8P HEX NIPPLE</b></p> <p><sup>2</sup></p>	<p><b>23053</b> <sup>4</sup></p>  <p><b>1/8P TEE</b></p> <p><sup>2</sup></p>	<p><b>23054</b> <sup>5</sup></p>  <p><b>1/4P TEE</b></p> <p><sup>2</sup></p>	<p><b>23055</b> <sup>6</sup></p>  <p><b>3/8P TEE</b></p> <p><sup>1</sup></p>
<p><b>20415</b> <sup>7</sup></p>  <p><b>1/8P CLOSE NIPPLE</b></p> <p><sup>4</sup></p>	<p><b>23037</b> <sup>8</sup></p>  <p><b>1/8P X 1-1/2 NIPPLE</b></p> <p><sup>3</sup></p>	<p><b>20417</b> <sup>9</sup></p>  <p><b>3/8P CLOSE NIPPLE</b></p> <p><sup>3</sup></p>	<p><b>23025</b> <sup>10</sup></p>  <p><b>1/8P COUPLER</b></p> <p><sup>3</sup></p>	<p><b>23026</b> <sup>11</sup></p>  <p><b>1/4P COUPLER</b></p> <p><sup>3</sup></p>	<p><b>23027</b> <sup>12</sup></p>  <p><b>3/8P COUPLER</b></p> <p><sup>2</sup></p>
<p><b>20416</b> <sup>13</sup></p>  <p><b>1/4P CLOSE NIPPLE</b></p> <p><sup>4</sup></p>	<p><b>23038</b> <sup>14</sup></p>  <p><b>1/4P X 1-1/2 NIPPLE</b></p> <p><sup>3</sup></p>	<p><b>20365</b> <sup>15</sup></p>  <p><b>3/8P X 2 NIPPLE</b></p> <p><sup>2</sup></p>	<p><b>23045</b> <sup>16</sup></p>  <p><b>1/8P 90 STREET ELBOW</b></p> <p><sup>2</sup></p>	<p><b>23046</b> <sup>17</sup></p>  <p><b>1/4P 90 STREET ELBOW</b></p> <p><sup>2</sup></p>	<p><b>23047</b> <sup>18</sup></p>  <p><b>3/8P 90 STREET ELBOW</b></p> <p><sup>2</sup></p>
<p><b>22321</b> <sup>19</sup></p>  <p><b>1/8P HEX HEAD PLUG</b></p> <p><sup>4</sup></p>	<p><b>20440</b> <sup>20</sup></p>  <p><b>1/4P HEX HEAD PLUG</b></p> <p><sup>4</sup></p>	<p><b>23012</b> <sup>21</sup></p>  <p><b>3/8P HEX HEAD PLUG</b></p> <p><sup>4</sup></p>	<p><b>23029</b> <sup>22</sup></p>  <p><b>1/4P X 1/8P REDUCER</b></p> <p><sup>4</sup></p>	<p><b>20412</b> <sup>23</sup></p>  <p><b>1/4P X 1/8P BUSHING</b></p> <p><sup>4</sup></p>	<p><b>20414</b> <sup>24</sup></p>  <p><b>3/8P X 1/4P BUSHING</b></p> <p><sup>3</sup></p>

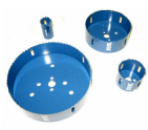
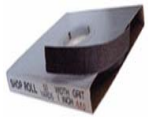



# J&B Fleet - Industrial Supply









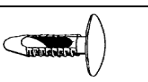















22428 Harrisburg-Westville Rd. Alliance, Ohio 44601 Phone: (330) 821-6342 Fax: (330) 821-0411

[www.jbfleet.com](http://www.jbfleet.com)

PART # 2013

## COMPRESSION BRASS



 <b>20279</b> <sup>1</sup> <b>3/16 SLEEVE</b> <sub>5</sub>	 <b>20284</b> <sup>2</sup> <b>3/16 NUT</b> <sub>5</sub>	 <b>20297</b> <sup>3</sup> <b>3/16T X 1/8P MALE CONNECTOR</b> <sub>2</sub>	 <b>20306</b> <sup>4</sup> <b>3/16T X 1/8P MALE ELBOW</b> <sub>2</sub>	 <b>20292</b> <sup>5</sup> <b>3/16 TUBE UNION</b> <sub>2</sub>	 <b>20326</b> <sup>6</sup> <b>3/16 TUBE MALE BRANCH TEE</b> <sub>1</sub>
 <b>20280</b> <sup>7</sup> <b>1/4 SLEEVE</b> <sub>5</sub>	 <b>20285</b> <sup>8</sup> <b>1/4 NUT</b> <sub>5</sub>	 <b>20298</b> <sup>9</sup> <b>1/4T X 1/8P MALE CONNECTOR</b> <sub>2</sub>	 <b>20307</b> <sup>10</sup> <b>1/4P X 1/8P MALE ELBOW</b> <sub>2</sub>	 <b>20293</b> <sup>11</sup> <b>1/4 TUBE UNION</b> <sub>3</sub>	 <b>20327</b> <sup>12</sup> <b>1/4 TUBE MALE BRANCH TEE</b> <sub>1</sub>
 <b>20281</b> <sup>13</sup> <b>5/16 SLEEVE</b> <sub>5</sub>	 <b>20286</b> <sup>14</sup> <b>5/16 NUT</b> <sub>5</sub>	 <b>20300</b> <sup>15</sup> <b>5/16T X 1/8P MALE CONNECTOR</b> <sub>2</sub>	 <b>20309</b> <sup>16</sup> <b>5/16T X 1/8P MALE ELBOW</b> <sub>2</sub>	 <b>20294</b> <sup>17</sup> <b>5/16 TUBE UNION</b> <sub>3</sub>	 <b>20328</b> <sup>18</sup> <b>5/16 TUBE MALE BRANCH TEE</b> <sub>1</sub>
 <b>20282</b> <sup>19</sup> <b>3/8 SLEEVE</b> <sub>5</sub>	 <b>20287</b> <sup>20</sup> <b>3/8 NUT</b> <sub>5</sub>	 <b>20303</b> <sup>21</sup> <b>3/8T X 1/8P MALE CONNECTOR</b> <sub>2</sub>	 <b>20312</b> <sup>22</sup> <b>3/8T X 1/8P MALE ELBOW</b> <sub>2</sub>	 <b>20295</b> <sup>23</sup> <b>3/8 TUBE UNION</b> <sub>3</sub>	 <b>20329</b> <sup>24</sup> <b>3/8 TUBE MALE BRANCH TEE</b> <sub>1</sub>



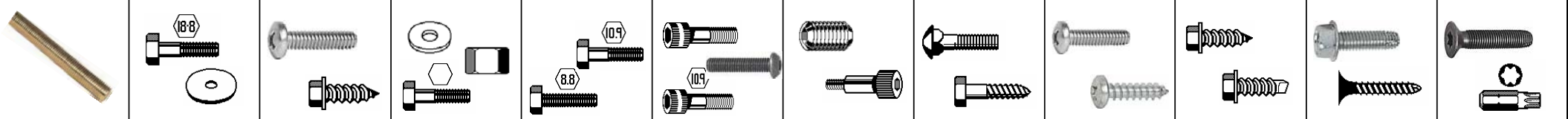











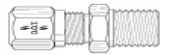
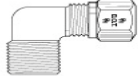

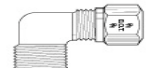

# J&B Fleet - Industrial Supply

22428 Harrisburg-Westville Rd. Alliance, Ohio 44601 Phone: (330) 821-6342 Fax: (330) 821-0411

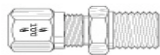
[www.jbfleet.com](http://www.jbfleet.com)

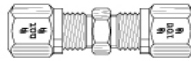
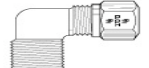
PART # 2070

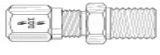
## NTA BRASS

<p>1</p>  <p><b>52050</b></p> <p>1/4T X 1/8P MALE CONNECTOR</p> <p>2</p>	<p>2</p>	<p>3</p>	<p>4</p>	<p>5</p>	<p>6</p>  <p><b>52088</b></p> <p>3/8T X 3/8P 90 MALE CONNECTOR</p> <p>1</p>
<p>7</p>  <p><b>52030</b></p> <p>1/4 INSERT</p> <p>10</p>	<p>8</p>  <p><b>52052</b></p> <p>1/4T X 1/4 P MALE CONNECTOR</p> <p>2</p>	<p>9</p>	<p>10</p>  <p><b>52032</b></p> <p>3/8 INSERT</p> <p>15</p>	<p>11</p>	<p>12</p>  <p><b>52086</b></p> <p>3/8T X 1/4P 90 MALE CONNECTOR</p> <p>2</p>
<p>13</p>  <p><b>52000</b></p> <p>1/4 SLEEVE</p> <p>15</p>	<p>14</p>	<p>15</p>  <p><b>52082</b></p> <p>1/4T X 1/4P 90 MALE CONNECTOR</p> <p>2</p>	<p>16</p>  <p><b>52002</b></p> <p>3/8 SLEEVE</p> <p>10</p>	<p>17</p>  <p><b>52058</b></p> <p>3/8T X 3/8P MALE CONNECTOR</p> <p>1</p>	<p>18</p>
<p>19</p>  <p><b>52010</b></p> <p>1/4 NUT</p> <p>10</p>	<p>20</p>  <p><b>52020</b></p> <p>1/4 UNION</p> <p>2</p>	<p>21</p>  <p><b>52080</b></p> <p>1/4T X 1/8P 90 MALE CONNECTOR</p> <p>1</p>	<p>22</p>  <p><b>52012</b></p> <p>3/8 NUT</p> <p>5</p>	<p>23</p>  <p><b>52056</b></p> <p>3/8T X 1/4P MALE CONNECTOR</p> <p>2</p>	<p>24</p>  <p><b>52022</b></p> <p>3/8 UNION</p> <p>2</p>

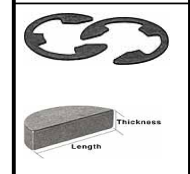
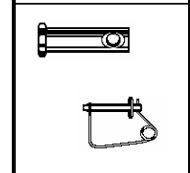
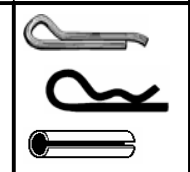
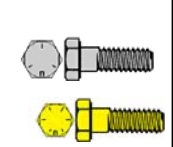
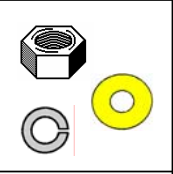
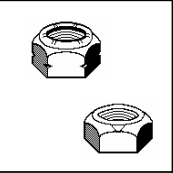
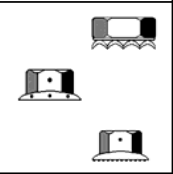
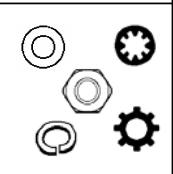

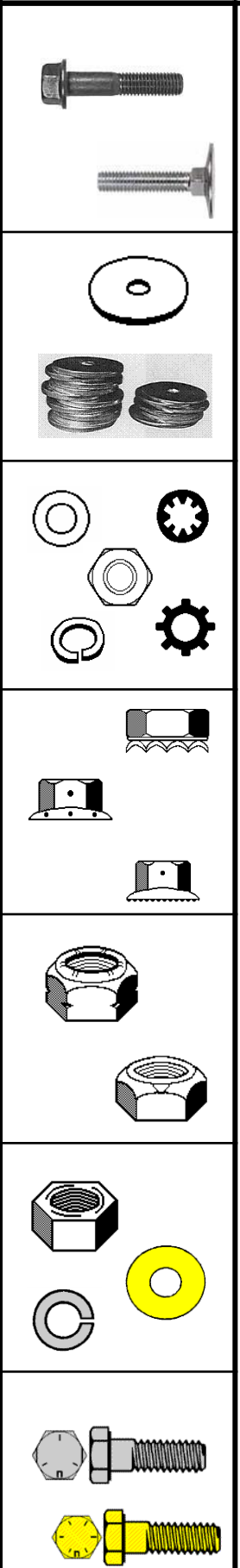
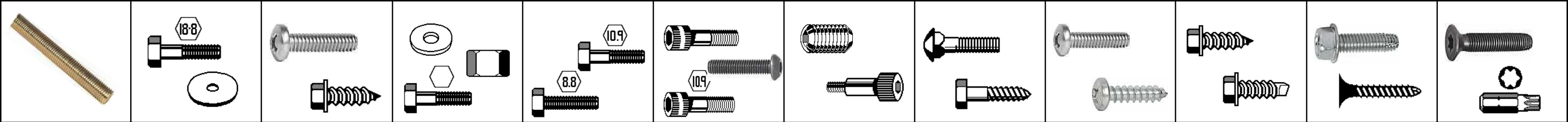













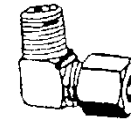

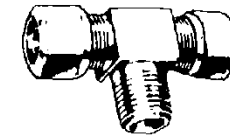

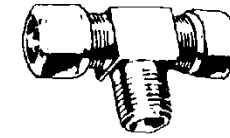
# J&B Fleet - Industrial Supply

22428 Harrisburg-Westville Rd. Alliance, Ohio 44601 Phone: (330) 821-6342 Fax: (330) 821-0411

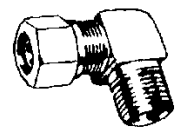
[www.jbfleet.com](http://www.jbfleet.com)

PART #2801

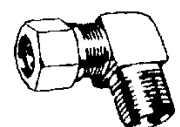
## 1/8 AND 1/4 NTA FITTINGS

 <b>20283</b> 1 <b>1/8" NUT</b> 5	 <b>20296</b> 2 <b>1/8 T X 1/8 P MALE CONNECTOR</b> 5	 <b>20305</b> 3 <b>1/8 T X 1/8 P MALE ELBOW</b> 5	 <b>20291</b> 4 <b>1/8 UNION</b> 3	 <b>52102</b> 6 <b>1/4 X 1/4 X 1/8 MALE BRANCH TEE</b> 1
 <b>52030</b> 7 <b>1/4" INSERT</b> 5	 <b>52054</b> 8 <b>1/4T X 3/8P MALE CONNECTOR</b> 2			 <b>52104</b> 12 <b>1/4 X 1/4 X 1/4 MALE BRANCH TEE</b> 1
 <b>52000</b> 13 <b>1/4" SLEEVE</b> 5	 <b>52052</b> 14 <b>1/4T X 1/4P MALE CONNECTOR</b> 2	 <b>52042</b> 15 <b>1/4T X 1/4P FEMALE CONNECTOR</b> 2	 <b>52082</b> 16 <b>1/4T X 1/4P 90° MALE ELBOW</b> 2	 <b>52110</b> 17 <b>1/4T X 1/8P 45° MALE ELBOW</b> 2
 <b>52010</b> 19 <b>1/4" NUT</b> 5	 <b>52050</b> 20 <b>1/4T X 1/8 P MALE CONNECTOR</b> 2	 <b>52040</b> 21 <b>1/4T X 1/8P FEMALE CONNECTOR</b> 2	 <b>52080</b> 22 <b>1/4T X 1/8P 90° MALE ELBOW</b> 2	 <b>52790</b> 23 <b>1/4T X 1/8P 45° MALE ELBOW</b> 2
				 <b>52020</b> 24 <b>1/4 UNION</b> 5

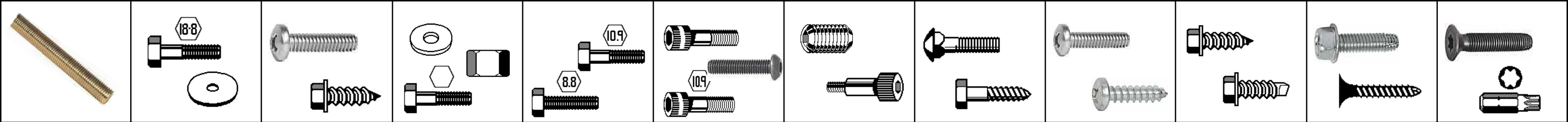











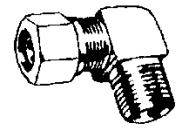



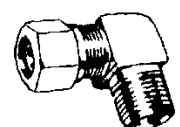

# J&B Fleet - Industrial Supply

22428 Harrisburg-Westville Rd. Alliance, Ohio 44601 Phone: (330) 821-6342 Fax: (330) 821-0411

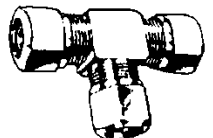
[www.jbfleet.com](http://www.jbfleet.com)

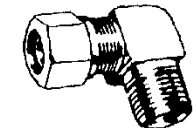
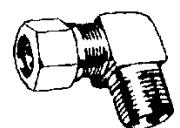
PART #2802

## 1/2 AND 5/8 NTA FITTINGS

<p>52006 <sup>1</sup></p>  <p>5/8 SLEEVE</p> <p>5</p>	<p>52096 <sup>2</sup></p>  <p>5/8 X 1/2 MALE ELBOW</p> <p>1</p>	<p>52068 <sup>3</sup></p>  <p>5/8T X 1/2P MALE CONNECTOR</p> <p>1</p>	<p>52036 <sup>4</sup></p>  <p>5/8 INSERT</p> <p>2</p>	<p>52016 <sup>5</sup></p>  <p>5/8 NUT</p> <p>2</p>	<p>52026 <sup>6</sup></p>  <p>5/8 UNION</p> <p>1</p>
<p>52034 <sup>7</sup></p>  <p>1/2 INSERT</p> <p>5</p>	<p>52064 <sup>14</sup></p>  <p>1/2T X 3/8P MALE CONNECTOR</p> <p>3</p>	<p>52066 <sup>15</sup></p>  <p>1/2T X 1/2P MALE CONNECTOR</p> <p>3</p>	<p>52094 <sup>16</sup></p>  <p>1/2T X 1/2P MALE ELBOW</p> <p>2</p>	<p>52118 <sup>17</sup></p>  <p>1/2T X 3/8P 45° ELBOW</p> <p>2</p>	<p>52794 <sup>12</sup></p>  <p>1/2 UNION TEE</p> <p>1</p>
<p>52004 <sup>13</sup></p>  <p>1/2 SLEEVE</p> <p>5</p>	<p>52062 <sup>20</sup></p>  <p>1/2T X 1/4P MALE CONNECTOR</p> <p>3</p>	<p>52095 <sup>21</sup></p>  <p>1/2T X 1/4P MALE CONNECTOR</p> <p>2</p>	<p>52092 <sup>22</sup></p>  <p>1/2T X 3/8P MALE ELBOW</p> <p>2</p>	<p>52792 <sup>23</sup></p>  <p>1/2T X 1/4P 45° ELBOW</p> <p>2</p>	<p>52793 <sup>18</sup></p>  <p>1/2T X 1/2P 45° ELBOW</p> <p>1</p>
<p>52014 <sup>19</sup></p>  <p>1/2 NUT</p> <p>5</p>	<p>52024 <sup>24</sup></p>  <p>1/2 UNION</p> <p>3</p>				

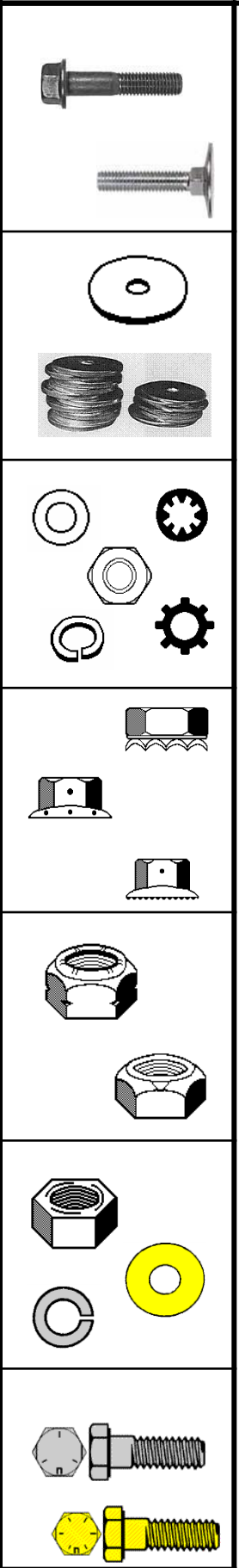



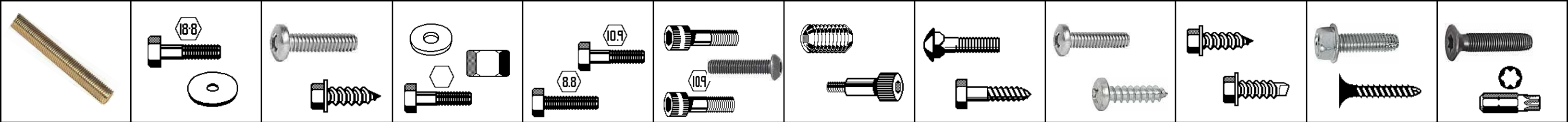











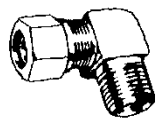
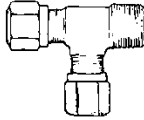
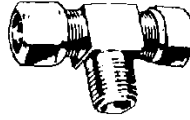



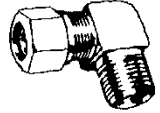

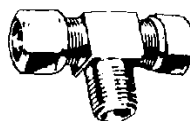

# J&B Fleet - Industrial Supply

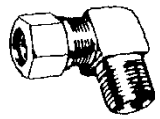
22428 Harrisburg-Westville Rd. Alliance, Ohio 44601 Phone: (330) 821-6342 Fax: (330) 821-0411

[www.jbfleet.com](http://www.jbfleet.com)

PART #2803

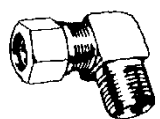
## 3/8 NTA FITTINGS

<p>1</p>  <p>52060</p> <p>3/8T X 1/2P MALE CONNECTOR</p> <p>2</p>	<p>3</p>  <p>52090</p> <p>3/8T X 1/2P MALE ELBOW</p> <p>4</p>	<p>5</p>  <p>52796</p> <p>3/8 T X 3/8P MALE RUN TEE</p> <p>5</p>	<p>6</p>  <p>52108</p> <p>3/8 T X 3/8P MALE BRANCH TEE</p> <p>6</p>		
<p>7</p>  <p>52032</p> <p>3/8 INSERT</p> <p>5</p>	<p>8</p>  <p>52058</p> <p>3/8T X 3/8P MALE CONNECTOR</p> <p>8</p>	<p>9</p>  <p>52046</p> <p>3/8T X 3/8P FEMALE CONNECTOR</p> <p>9</p>	<p>10</p>  <p>52088</p> <p>3/8T X 3/8P MALE ELBOW</p> <p>10</p>	<p>11</p>  <p>52116</p> <p>3/8T X 3/8P 45° MALE ELBOW</p> <p>11</p>	<p>12</p>  <p>52106</p> <p>3/8 T X 1/4P MALE BRANCH TEE</p> <p>12</p>
<p>13</p>  <p>52002</p> <p>3/8 SLEEVE</p> <p>13</p>	<p>14</p>  <p>52056</p> <p>3/8T X 1/4P MALE CONNECTOR</p> <p>14</p>	<p>15</p>  <p>52044</p> <p>3/8T X 1/4P FEMALE CONNECTOR</p> <p>15</p>	<p>16</p>  <p>52086</p> <p>3/8T X 1/4P MALE ELBOW</p> <p>16</p>	<p>17</p>  <p>52114</p> <p>3/8T X 1/4P 45° MALE ELBOW</p> <p>17</p>	<p>18</p>  <p>52072</p> <p>3/8 UNION TEE</p> <p>18</p>
<p>19</p>  <p>52012</p> <p>3/8 NUT</p> <p>19</p>	<p>20</p>  <p>52785</p> <p>3/8T X 1/8P MALE CONNECTOR</p> <p>20</p>	<p>21</p>  <p>52788</p> <p>3/8T X 1/8P FEMALE CONNECTOR</p> <p>21</p>	<p>22</p>  <p>52084</p> <p>3/8T X 1/8P MALE ELBOW</p> <p>22</p>	<p>23</p>  <p>52112</p> <p>3/8T X 1/8P 45° MALE ELBOW</p> <p>23</p>	<p>24</p>  <p>52022</p> <p>3/8 UNION</p> <p>24</p>

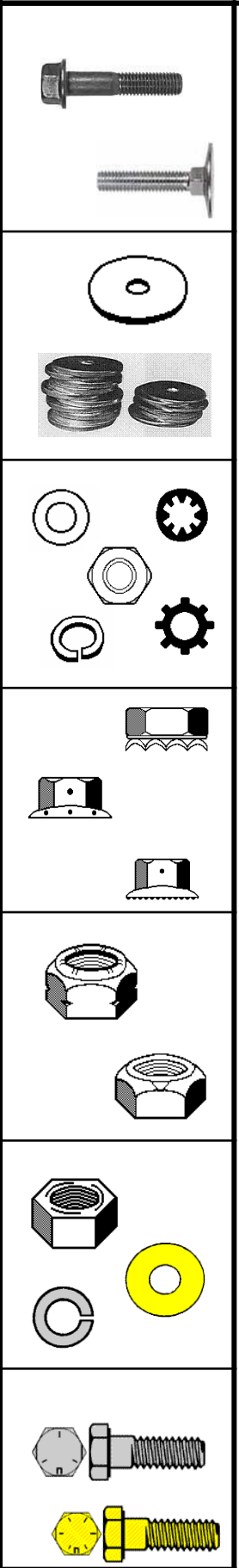



# J&B Fleet - Industrial Supply















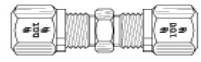
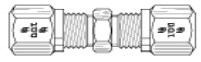

22428 Harrisburg-Westville Rd. Alliance, Ohio 44601 Phone: (330) 821-6342 Fax: (330) 821-0411

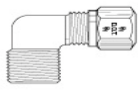
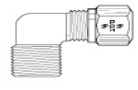
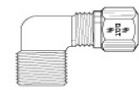
www.jbfleet.com

PART # 2073

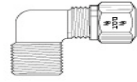
## NTA BRASS

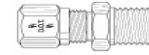

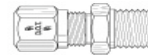
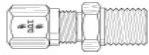
 <b>52014</b> <sup>1</sup> <b>1/2 NUT</b> <sup>2</sup>	 <b>52004</b> <sup>2</sup> <b>1/2 SLEEVE</b> <sup>5</sup>	 <b>52034</b> <sup>3</sup> <b>1/2 INSERT</b> <sup>4</sup>	 <b>52020</b> <sup>4</sup> <b>1/4 UNION</b> <sup>3</sup>	 <b>52022</b> <sup>5</sup> <b>3/8 UNION</b> <sup>2</sup>	 <b>52024</b> <sup>6</sup> <b>1/2 UNION</b> <sup>2</sup>
 <b>52012</b> <sup>7</sup> <b>3/8 NUT</b> <sup>10</sup>	 <b>52002</b> <sup>8</sup> <b>3/8 SLEEVE</b> <sup>10</sup>	 <b>52032</b> <sup>9</sup> <b>3/8 INSERT</b> <sup>10</sup>	 <b>52080</b> <sup>10</sup> <b>1/4T X 1/8P 90 MALE CONNECTOR</b> <sup>2</sup>	 <b>52086</b> <sup>11</sup> <b>3/8T X 1/4P 90 MALE CONNECTOR</b> <sup>2</sup>	 <b>52092</b> <sup>12</sup> <b>1/2T X 3/8P 90 MALE CONNECTOR</b> <sup>1</sup>
 <b>52010</b> <sup>13</sup> <b>1/4 NUT</b> <sup>10</sup>	 <b>52000</b> <sup>14</sup> <b>1/4 SLEEVE</b> <sup>15</sup>	 <b>52030</b> <sup>15</sup> <b>1/4 INSERT</b> <sup>15</sup>	 <b>52082</b> <sup>16</sup> <b>1/4T X 1/4P 90 MALE CONNECTOR</b> <sup>2</sup>	 <b>52088</b> <sup>17</sup> <b>3/8T X 3/8P 90 MALE CONNECTOR</b> <sup>2</sup>	 <b>52094</b> <sup>18</sup> <b>1/2T X 1/2P 90 MALE CONNECTOR</b> <sup>1</sup>
 <b>52050</b> <sup>19</sup> <b>1/4T X 1/8P MALE CONNECTOR</b> <sup>3</sup>	 <b>52052</b> <sup>20</sup> <b>1/4T X 1/4P MALE CONNECTOR</b> <sup>3</sup>	 <b>52056</b> <sup>21</sup> <b>3/8T X 1/4P MALE CONNECTOR</b> <sup>2</sup>	 <b>52058</b> <sup>22</sup> <b>3/8T X 3/8P MALE CONNECTOR</b> <sup>2</sup>	 <b>52064</b> <sup>23</sup> <b>1/2T X 3/8P MALE CONNECTOR</b> <sup>1</sup>	 <b>52066</b> <sup>24</sup> <b>1/2T X 1/2P MALE CONNECTOR</b> <sup>1</sup>

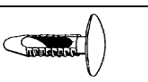

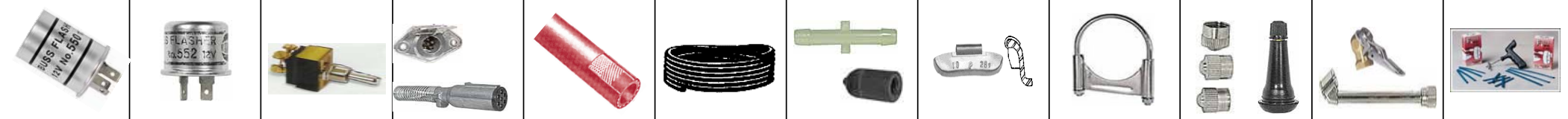





















## J&B Fleet - Industrial Supply

22428 Harrisburg-Westville Rd. Alliance, Ohio 44601 Phone: (330) 821-6342 Fax: (330) 821-0411

[www.jbfleet.com](http://www.jbfleet.com)

PART # 2090

## PRESTOLOK

 <p><b>54540</b> <sup>1</sup></p> <p>1/8 T X 1/8 P 90 MALE ELBOW</p> <p>2</p>	 <p><b>54542</b> <sup>2</sup></p> <p>5/32 T X 1/8 P 90 MALE ELBOW</p> <p>2</p>	 <p><b>54543</b> <sup>3</sup></p> <p>1/4 T X 1/8 P 90 MALE ELBOW</p> <p>2</p>	 <p><b>54544</b> <sup>4</sup></p> <p>1/4 T X 1/4 P 90 MALE ELBOW</p> <p>2</p>	 <p><b>54550</b> <sup>5</sup></p> <p>3/8 T X 1/4 P 90 MALE ELBOW</p> <p>1</p>	 <p><b>54551</b> <sup>6</sup></p> <p>3/8 T X 3/8 P 90 MALE ELBOW</p> <p>1</p>
 <p><b>52762</b> <sup>7</sup></p> <p>1/8 T X 1/16 P MALE CONNECTOR</p> <p>2</p>	 <p><b>54520</b> <sup>8</sup></p> <p>1/8 T X 1/8 P MALE CONNECTOR</p> <p>2</p>	 <p><b>54522</b> <sup>9</sup></p> <p>5/32 T X 1/8 P MALE CONNECTOR</p> <p>2</p>	 <p><b>54524</b> <sup>10</sup></p> <p>1/4 T X 1/8 P MALE CONNECTOR</p> <p>2</p>	 <p><b>54526</b> <sup>11</sup></p> <p>1/4 T X 1/4 P MALE CONNECTOR</p> <p>2</p>	 <p><b>54532</b> <sup>12</sup></p> <p>3/8 T X 1/4 P MALE CONNECTOR</p> <p>1</p>
 <p><b>54500</b> <sup>13</sup></p> <p>1/8 T UNION</p> <p>2</p>	 <p><b>54502</b> <sup>14</sup></p> <p>5/32 T UNION</p> <p>2</p>	 <p><b>54504</b> <sup>15</sup></p> <p>1/4 T UNION</p> <p>2</p>	 <p><b>54506</b> <sup>16</sup></p> <p>3/8 T UNION</p> <p>1</p>		 <p><b>54533</b> <sup>18</sup></p> <p>3/8 T X 3/8 P MALE CONNECTOR</p> <p>1</p>
 <p><b>54560</b> <sup>19</sup></p> <p>1/8 T UNION TEE</p> <p>1</p>	 <p><b>54562</b> <sup>20</sup></p> <p>5/32 T UNION TEE</p> <p>1</p>	 <p><b>54564</b> <sup>21</sup></p> <p>1/4 T UNION TEE</p> <p>1</p>	 <p><b>54566</b> <sup>22</sup></p> <p>3/8 T UNION TEE</p> <p>1</p>		



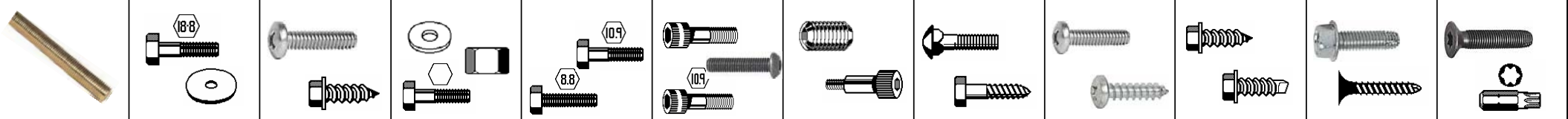















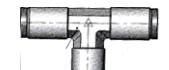

# J&B Fleet - Industrial Supply

22428 Harrisburg-Westville Rd. Alliance, Ohio 44601 Phone: (330) 821-6342 Fax: (330) 821-0411

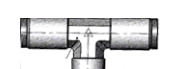
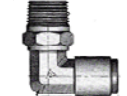
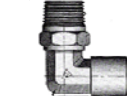
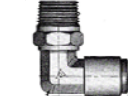
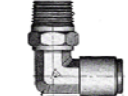
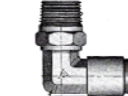
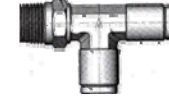
[www.jbfleet.com](http://www.jbfleet.com)

PART # 2227

## PRESS TO CONNECT FITTINGS

<p>54825 <sup>1</sup></p>  <p>1/4 UNION</p> <p><sup>2</sup></p>	<p>54826 <sup>2</sup></p>  <p>3/8 UNION</p> <p><sup>2</sup></p>	<p>54860 <sup>3</sup></p>  <p>MALE ELBOW 45 1/4T X 1/4P</p> <p><sup>2</sup></p>	<p>54862 <sup>4</sup></p>  <p>MALE ELBOW 45 3/8T X 1/4P</p> <p><sup>1</sup></p>	<p>54863 <sup>5</sup></p>  <p>MALE ELBOW 45 3/8T X 3/8P</p> <p><sup>1</sup></p>	<p>54830 <sup>6</sup></p>  <p>1/4 UNION TEE</p> <p><sup>1</sup></p>
<p>54834 <sup>7</sup></p>  <p>1/4T X 1/8P MALE CONNECTOR</p> <p><sup>2</sup></p>	<p>54835 <sup>8</sup></p>  <p>1/4T X 1/4P MALE CONNECTOR</p> <p><sup>2</sup></p>	<p>54837 <sup>9</sup></p>  <p>3/8T X 1/8P MALE CONNECTOR</p> <p><sup>1</sup></p>	<p>54838 <sup>10</sup></p>  <p>3/8T X 1/4P MALE CONNECTOR</p> <p><sup>2</sup></p>	<p>54839 <sup>11</sup></p>  <p>3/8T X 3/8P MALE CONNECTOR</p> <p><sup>1</sup></p>	<p>54831 <sup>12</sup></p>  <p>3/8 UNION TEE</p> <p><sup>1</sup></p>
<p>54846 <sup>13</sup></p>  <p>1/4T X 1/8P MALE ELBOW 90 SWIVEL</p> <p><sup>2</sup></p>	<p>54847 <sup>14</sup></p>  <p>1/4T X 1/4P MALE ELBOW 90 SWIVEL</p> <p><sup>2</sup></p>	<p>54849 <sup>15</sup></p>  <p>3/8T X 3/8P MALE ELBOW 90 SWIVEL</p> <p><sup>1</sup></p>	<p>54850 <sup>16</sup></p>  <p>3/8T X 1/4P MALE ELBOW 90 SWIVEL</p> <p><sup>2</sup></p>	<p>54851 <sup>17</sup></p>  <p>3/8T X 3/8P MALE ELBOW 90 SWIVEL</p> <p><sup>1</sup></p>	<p>54869 <sup>18</sup></p>  <p>3/8T X 1/4 P MALE RUN TEE 90 SWIVEL</p> <p><sup>1</sup></p>
<p>54880 <sup>19</sup></p>  <p>1/4 BULKHEAD UNION</p> <p><sup>1</sup></p>	<p>54881 <sup>20</sup></p>  <p>3/8 BULKHEAD UNION</p> <p><sup>1</sup></p>	<p>54872 <sup>21</sup></p>  <p>1/4T X 1/8P MALE BRANCH TEE SWIVEL</p> <p><sup>1</sup></p>	<p>54873 <sup>22</sup></p>  <p>1/4T X 1/4P MALE BRANCH TEE SWIVEL</p> <p><sup>1</sup></p>	<p>54875 <sup>23</sup></p>  <p>3/8T X 1/4P MALE BRANCH TEE SWIVEL</p> <p><sup>1</sup></p>	<p>54879 <sup>24</sup></p>  <p>3/8T X 3/8P MALE BRANCH TEE SWIVEL</p> <p><sup>1</sup></p>





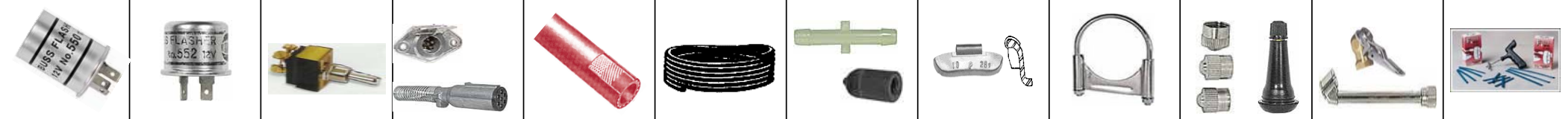





















## J&B Fleet - Industrial Supply

www.jbfleet.com

22428 Harrisburg-Westville Rd. Alliance, Ohio 44601 Phone: (330) 821-6342 Fax: (330) 821-0411

PART # 2091

# PRESS TO CONNECT FITTINGS

 <b>54822</b> <sup>1</sup> 1/8 T X 1/8 P 90 MALE ELBOW <sub>2</sub>	 <b>54823</b> <sup>2</sup> 5/32 T X 1/8 P 90 MALE ELBOW <sub>2</sub>	 <b>54846</b> <sup>3</sup> 1/4 T X 1/8 P 90 MALE ELBOW <sub>2</sub>	 <b>54847</b> <sup>4</sup> 1/4 T X 1/4 P 90 MALE ELBOW <sub>2</sub>	 <b>54850</b> <sup>5</sup> 3/8 T X 1/4 P 90 MALE ELBOW <sub>1</sub>	 <b>54851</b> <sup>6</sup> 3/8 T X 3/8 P 90 MALE ELBOW <sub>1</sub>
 <b>54813</b> <sup>7</sup> 1/8 T X 1/16 P MALE CONNECTOR <sub>2</sub>	 <b>54814</b> <sup>8</sup> 1/8 T X 1/8 P MALE CONNECTOR <sub>2</sub>	 <b>54816</b> <sup>9</sup> 5/32 T X 1/8 P MALE CONNECTOR <sub>2</sub>	 <b>54834</b> <sup>10</sup> 1/4 T X 1/8 P MALE CONNECTOR <sub>2</sub>	 <b>54835</b> <sup>11</sup> 1/4 T X 1/4 P MALE CONNECTOR <sub>2</sub>	 <b>54838</b> <sup>12</sup> 3/8 T X 1/4 P MALE CONNECTOR <sub>1</sub>
 <b>54802</b> <sup>13</sup> 1/8 T UNION <sub>2</sub>	 <b>54803</b> <sup>14</sup> 5/32 T UNION <sub>2</sub>	 <b>54830</b> <sup>15</sup> 1/4 T UNION <sub>2</sub>	 <b>54831</b> <sup>16</sup> 3/8 T UNION <sub>1</sub>		 <b>54839</b> <sup>18</sup> 3/8 T X 3/8 P MALE CONNECTOR <sub>1</sub>
 <b>54802</b> <sup>19</sup> 1/8 T UNION TEE <sub>1</sub>	 <b>54803</b> <sup>20</sup> 5/32 T UNION TEE <sub>1</sub>	 <b>54830</b> <sup>21</sup> 1/4 T UNION TEE <sub>1</sub>	 <b>54831</b> <sup>22</sup> 3/8 T UNION TEE <sub>1</sub>		

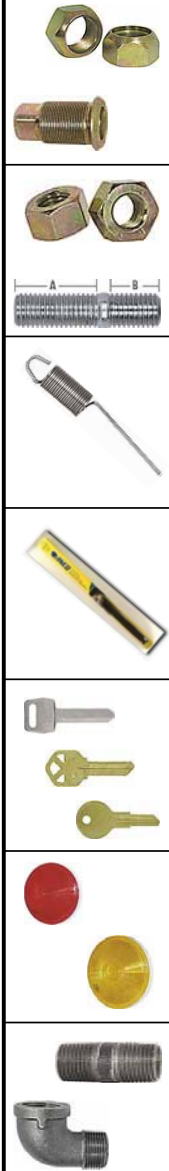



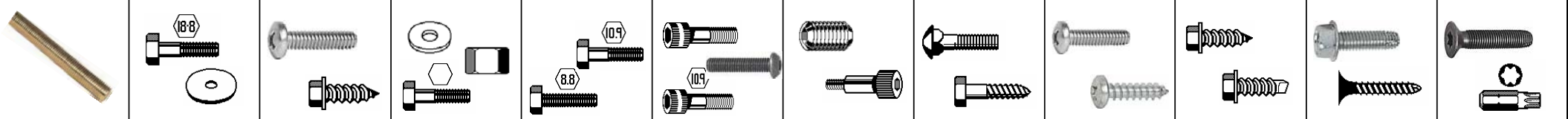

# J&B Fleet - Industrial Supply

22428 Harrisburg-Westville Rd. Alliance, Ohio 44601 Phone: (330) 821-6342 Fax: (330) 821-0411

[www.jbfleet.com](http://www.jbfleet.com)

PART # 2226

## PRESS TO CONNECT FITTINGS

1	2	3	4 54825	5 54826	6 54827
			2 1/4 UNION	2 3/8 UNION	1 1/2 UNION
7 54834	8 54835	9 54838	10 54839	11 54842	12 54843
2 MALE CONNECTOR 1/4T X 1/8P	2 MALE CONNECTOR 1/4T X 1/4P	2 MALE CONNECTOR 3/8T X 1/4P	2 MALE CONNECTOR 3/8T X 3/8P	1 MALE CONNECTOR 1/2T X 3/8P	1 MALE CONNECTOR 1/2T X 1/2P
13 54846	14 54847	15 54850	16 54851	17	18 54854
2 MALE ELBOW SWIVEL 90 1/4T X 1/8P	2 MALE ELBOW SWIVEL 90 1/4T X 1/4P	2 MALE ELBOW SWIVEL 90 3/8T X 1/4P	2 MALE ELBOW SWIVEL 90 3/8T X 3/8P		1 MALE ELBOW SWIVEL 90 1/2T X 3/8P
19	20	21	22 54830	23 54831	24 54832
			1 UNION TEE 1/4	1 UNION TEE 3/8	1 UNION TEE 1/2



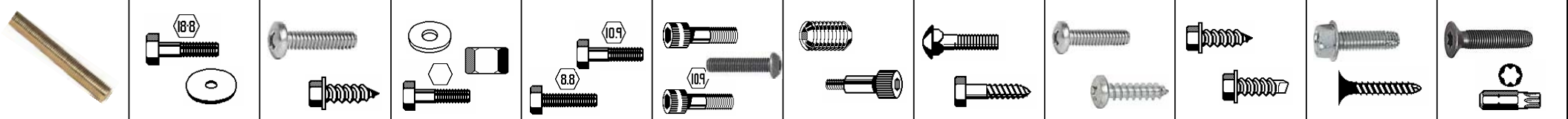



















**J&B Fleet - Industrial Supply**  
 22428 Harrisburg-Westville Rd. Alliance, Ohio 44601

[www.jbfleet.com](http://www.jbfleet.com)

**PART # 2250**

**John Guest Fittings**

<p><b>PI 051223 S</b> <sup>1</sup></p>  <p><b>3/8 Stem 3/8 NPT Stem Adapter</b></p> <p>2</p>	<p>2</p>	<p><b>PI 011222 S</b> <sup>3</sup></p>  <p><b>3/8 T x 1/4 P Male Conn</b></p> <p>2</p>	<p>4</p>	<p><b>PI 091222 S</b> <sup>5</sup></p>  <p><b>3/8 T x 1/4 P 90° Male Elbow</b></p> <p>2</p>	<p><b>PI 0212S</b> <sup>6</sup></p>  <p><b>3/8 Tube Union Tee</b></p> <p>2</p>
<p><b>PI 051222 S</b> <sup>7</sup></p>  <p><b>3/8 Stem 1/4 NPT Stem Adapter</b></p> <p>2</p>	<p>8</p>	<p><b>PI 011221 S</b> <sup>9</sup></p>  <p><b>3/8 T x 1/8 P Male Conn</b></p> <p>2</p>	<p><b>PI 011223 S</b> <sup>10</sup></p>  <p><b>3/8 T x 3/8 P Male Conn</b></p> <p>2</p>	<p><b>PI 0412 S</b> <sup>11</sup></p>  <p><b>3/8 Tube Union</b></p> <p>2</p>	<p><b>PI 0312 S</b> <sup>12</sup></p>  <p><b>3/8 Tube 90° Union Elbow</b></p> <p>2</p>
<p><b>PI 050822 S</b> <sup>13</sup></p>  <p><b>1/4 Stem 1/4 NPT Stem Adapter</b></p> <p>2</p>	<p>14</p>	<p><b>PI 010822 S</b> <sup>15</sup></p>  <p><b>1/4 T x 1/4 P Male Conn</b></p> <p>2</p>	<p>16</p>	<p><b>PI 090822 S</b> <sup>17</sup></p>  <p><b>1/4 T x 1/4 P 90° Male Elbow</b></p> <p>2</p>	<p><b>PI 0208 S</b> <sup>18</sup></p>  <p><b>1/4 Tube Union Tee</b></p> <p>2</p>
<p><b>PI 050821 S</b> <sup>19</sup></p>  <p><b>1/4 Stem 1/8 NPT Stem Adapter</b></p> <p>2</p>	<p>20</p>	<p><b>PI 010821 S</b> <sup>21</sup></p>  <p><b>1/4 T x 1/8 P Male Conn</b></p> <p>2</p>	<p><b>PI 010823 S</b> <sup>22</sup></p>  <p><b>1/4 T x 3/8 P Male Conn</b></p> <p>2</p>	<p><b>PI 0408 S</b> <sup>23</sup></p>  <p><b>1/4 Tube Union</b></p> <p>2</p>	<p><b>PI 0308 S</b> <sup>24</sup></p>  <p><b>1/4 Tube 90° Union Elbow</b></p> <p>2</p>



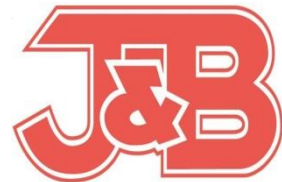
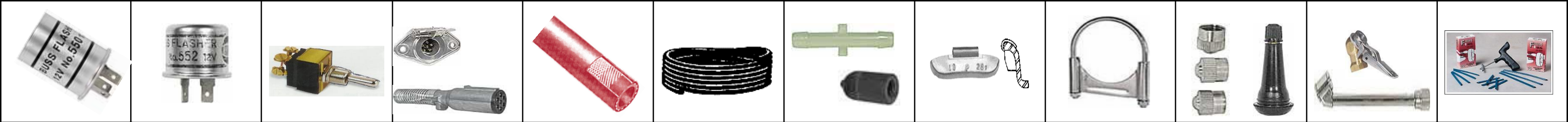















# J&B Fleet - Industrial Supply

www.jbfleet.com

22428 Harrisburg-Westville Rd. Alliance, Ohio 44601 Phone: (330) 821-6342 Fax: (330) 821-0411

**PART# 2860**

## REUSABLE HOSE ENDS - AIRBRAKE

<p><b>20842</b></p>  <p><b>3/8H-1/4P CONNECTOR</b></p> <p>2</p>	<p><b>20855</b></p>  <p><b>1/2H-1/2P CONNECTOR</b></p> <p>1</p>	<p><b>20850</b></p>  <p><b>1/2 SLEEVE</b></p> <p>2</p>	<p><b>21498</b></p>  <p><b>3/8H-3/8P CONNECTOR W/ SPRING GUARD</b></p> <p>2</p>
<p><b>21517</b></p>  <p><b>3/8H-3/8P CONNECTOR</b></p> <p>2</p>	<p><b>20841</b></p>  <p><b>3/8 SLEEVE</b></p> <p>3</p>	<p><b>20844</b></p>  <p><b>3/8 NUT</b></p> <p>3</p>	<p><b>20846</b></p>  <p><b>3/8H-1/2P CONNECTOR W/ SPRING GUARD</b></p> <p>2</p>
<p><b>20843</b></p>  <p><b>3/8H-1/2P CONNECTOR</b></p> <p>2</p>	<p><b>22197</b></p>  <p><b>1/2 UNION</b></p> <p>1</p>	<p><b>20852</b></p>  <p><b>1/2 NUT</b></p> <p>2</p>	
<p><b>20854</b></p>  <p><b>1/2H-3/8P CONNECTOR</b></p> <p>2</p>	<p><b>20809</b></p>  <p><b>3/8 UNION</b></p> <p>2</p>	<p><b>20845</b></p>  <p><b>3/8H-1/4P CONNECTOR W/ SPRING GUARD</b></p> <p>2</p>	

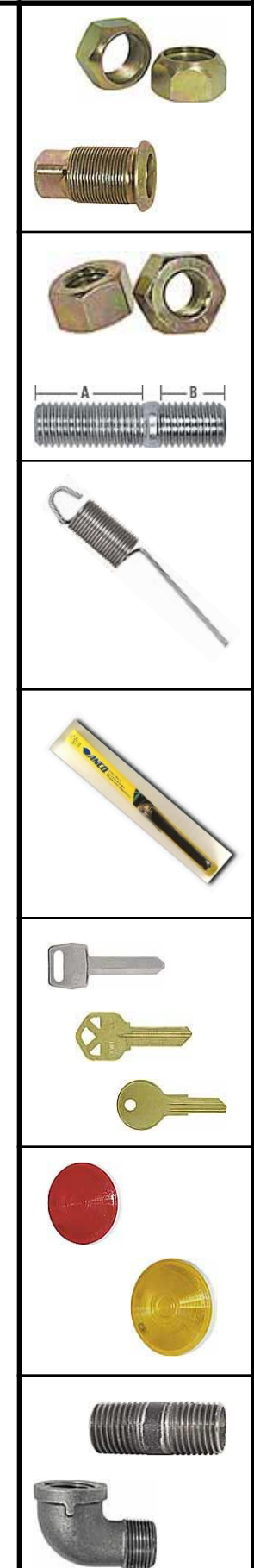





# J&B Fleet - Industrial Supply

























22428 Harrisburg-Westville Rd. Alliance, Ohio 44601 Phone: (330) 821-6342 Fax: (330) 821-0411

[www.jbfleet.com](http://www.jbfleet.com)

PART # 2014

## SAE FLARE BRASS



<p><b>20345</b> <sup>1</sup></p>  <p>48 X 3 3/16 X 1/8 MALE CONNECTOR</p>	<p><b>20346</b> <sup>2</sup></p>  <p>48 X 4 1/4 X 1/8 MALE CONNECTOR</p>	<p><b>20347</b> <sup>3</sup></p>  <p>48 X 4 X 4 1/4 X 1/4 MALE CONNECTOR</p>	<p><b>20348</b> <sup>4</sup></p>  <p>48 X 5 5/16 X 1/8 MALE CONNECTOR</p>	<p><b>20349</b> <sup>5</sup></p>  <p>48 X 5 X 4 5/16 X 1/4 MALE CONNECTOR</p>	<p><b>20330</b> <sup>6</sup></p>  <p>41 X 3 3/16 TUBE LONG NUT</p>
<p><b>20354</b> <sup>7</sup></p>  <p>49 X 3 3/16 X 1/8 90 MALE ELBOW</p>	<p><b>20355</b> <sup>8</sup></p>  <p>49 X 4 1/4 X 1/8 90 MALE ELBOW</p>	<p><b>20356</b> <sup>9</sup></p>  <p>49 X 4 X 4 1/4 X 1/4 90 MALE ELBOW</p>	<p><b>20357</b> <sup>10</sup></p>  <p>49 X 5 5/16 X 1/8 90 MALE ELBOW</p>	<p><b>20358</b> <sup>11</sup></p>  <p>49 X 5 X 4 5/16 X 1/4 90 MALE ELBOW</p>	<p><b>20331</b> <sup>12</sup></p>  <p>41 X 4 1/4 TUBE LONG NUT</p>
<p><b>20340</b> <sup>13</sup></p>  <p>42 X 3 3/16 TUBE UNION</p>	<p><b>20341</b> <sup>14</sup></p>  <p>42 X 4 1/4 TUBE UNION</p>	<p><b>20342</b> <sup>15</sup></p>  <p>42 X 5 5/16 TUBE UNION</p>	<p><b>22106</b> <sup>16</sup></p>  <p>55 X 4 1/4 TUBE FEM CONNECTOR</p>	<p><b>22108</b> <sup>17</sup></p>  <p>55 X 5 5/16 TUBE FEM CONNECTOR</p>	<p><b>20332</b> <sup>18</sup></p>  <p>41 X 5 5/16 TUBE LONG NUT</p>
<p><b>20373</b> <sup>19</sup></p>  <p>44 X 3 3/16T X 1/8P MALE BRANCH TEE</p>	<p><b>20374</b> <sup>20</sup></p>  <p>44 X 4 1/4 TUBE MALE BRANCH TEE</p>	<p><b>20375</b> <sup>21</sup></p>  <p>44 X 5 5/16 TUBE MALE BRANCH TEE</p>	<p><b>20335</b> <sup>22</sup></p>  <p>1110 X 3 3/16 SHORT NUT</p>	<p><b>20336</b> <sup>23</sup></p>  <p>1110 X 4 1/4 SHORT NUT</p>	<p><b>20337</b> <sup>24</sup></p>  <p>1110 X 5 5/16 SHORT NUT</p>



# J&B Fleet - Industrial Supply

























22428 Harrisburg-Westville Rd. Alliance, Ohio 44601 Phone: (330) 821-6342 Fax: (330) 821-0411

[www.jbfleet.com](http://www.jbfleet.com)

PART # 2022

## INVERTED FLARE BRASS



<p><b>20378</b> <sup>1</sup></p>  <p>105 X 3 3/16 NUT</p> <p>10</p>	<p><b>20383</b> <sup>2</sup></p>  <p>200 X 3 3/16 X 1/8 MALE CONNECTOR</p> <p>5</p>	<p><b>20403</b> <sup>3</sup></p>  <p>352 X 3 3/16 X 1/8 45 ELBOW</p> <p>2</p>	<p><b>20395</b> <sup>4</sup></p>  <p>400 X 6 X 2 3/8 X 1/8 90 ELBOW</p> <p>2</p>	<p><b>20390</b> <sup>5</sup></p>  <p>400 X 3 3/16 X 1/8 90 ELBOW</p> <p>2</p>	<p><b>20399</b> <sup>6</sup></p>  <p>300 X 3 3/16 TUBE UNION</p> <p>5</p>
<p><b>20379</b> <sup>7</sup></p>  <p>105 X 4 1/4 NUT</p> <p>10</p>	<p><b>20384</b> <sup>8</sup></p>  <p>200 X 4 1/4 X 1/8 MALE CONNECTOR</p> <p>5</p>	<p><b>20404</b> <sup>9</sup></p>  <p>352 X 4 1/4 X 1/8 45 ELBOW</p> <p>2</p>	<p><b>20407</b> <sup>10</sup></p>  <p>352 X 6 3/8 X 1/4 45 ELBOW</p> <p>2</p>	<p><b>20391</b> <sup>11</sup></p>  <p>400 X 4 1/4 X 1/8 90 ELBOW</p> <p>2</p>	<p><b>20400</b> <sup>12</sup></p>  <p>300 X 4 1/4 TUBE UNION</p> <p>5</p>
<p><b>20380</b> <sup>13</sup></p>  <p>150 X 5 5/16 NUT</p> <p>10</p>	<p><b>20385</b> <sup>14</sup></p>  <p>200 X 5 5/16 X 1/8 MALE CONNECTOR</p> <p>5</p>	<p><b>21424</b> <sup>15</sup></p>  <p>200 X 5 X 4 5/16 X 1/4 MALE CONNECTOR</p> <p>3</p>	<p><b>20405</b> <sup>16</sup></p>  <p>352 X 5 5/16 X 1/8 45 ELBOW</p> <p>2</p>	<p><b>20392</b> <sup>17</sup></p>  <p>400 X 5 5/16 X 1/8 90 ELBOW</p> <p>2</p>	<p><b>20401</b> <sup>18</sup></p>  <p>300 X 5 5/16 TUBE UNION</p> <p>3</p>
<p><b>20381</b> <sup>19</sup></p>  <p>150 X 6 3/8 NUT</p> <p>10</p>	<p><b>20386</b> <sup>20</sup></p>  <p>200 X 6 X 2 3/8 X 1/8 MALE CONNECTOR</p> <p>3</p>	<p><b>20387</b> <sup>21</sup></p>  <p>200 X 6 3/8 X 1/4 MALE CONNECTOR</p> <p>2</p>	<p><b>20406</b> <sup>22</sup></p>  <p>352 X 5 X 4 5/16 X 1/4 45 ELBOW</p> <p>2</p>	<p><b>20396</b> <sup>23</sup></p>  <p>400 X 6 3/8 X 1/4 90 ELBOW</p> <p>2</p>	<p><b>20402</b> <sup>24</sup></p>  <p>300 X 6 3/8 TUBE UNION</p> <p>2</p>



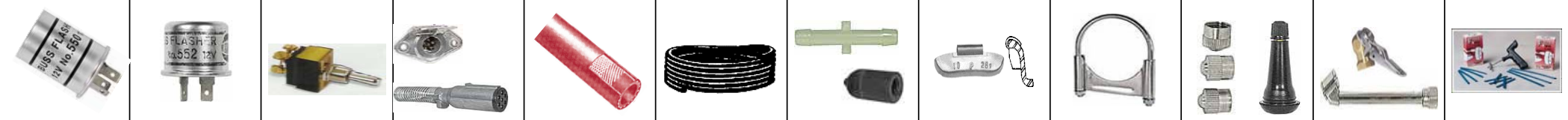

# J&B Fleet - Industrial Supply

22428 Harrisburg-Westville Rd. Alliance, Ohio 44601 Phone: (330) 821-6342 Fax: (330) 821-0411

[www.jbfleet.com](http://www.jbfleet.com)

PART # 2124

## BRAKELINE ADAPTERS

 <b>20377</b> 1 1/8 NUT	 <b>20378</b> 2 3/16 NUT	 <b>20379</b> 3 1/4 NUT	 <b>20380</b> 4 5/16 NUT	 <b>20381</b> 5 3/8 NUT	 <b>20398</b> 6 1/8 UNION	 <b>20399</b> 7 3/16 UNION	 <b>20400</b> 8 1/4 UNION
 <b>20401</b> 9 5/16 UNION	 <b>20402</b> 10 3/8 UNION	 <b>20383</b> 11 3/16T - 1/8P 3 MALE CONN.	 <b>20384</b> 12 1/4T - 1/8P 3 MALE CONN.	 <b>20385</b> 13 5/16T - 1/8P 3 MALE CONN.	 <b>21424</b> 14 5/16T - 1/4P 3 MALE CONN.	 <b>20387</b> 15 3/8T - 1/4P 2 MALE CONN.	 <b>40371</b> 16 3/16F - 5/16M 1 CONVERSION
 <b>40370</b> 17 3/16F - 1/4M 1 CONVERSION	 <b>40378</b> 18 1/4F - 9/16-18M 1 CONVERSION	 <b>40375</b> 19 3/16F - 9/16-18M 1 CONVERSION	 <b>40374</b> 20 1/4F - 5/16M 1 CONVERSION	 <b>40372</b> 21 1/4F - 3/16M 1 CONVERSION	 <b>20403</b> 22 3/16T - 1/8P 1 45° ELBOW	 <b>20404</b> 23 1/4T - 1/8P 1 45° ELBOW	 <b>20406</b> 24 5/16T - 1/4P 1 45° ELBOW
 <b>20407</b> 25 3/8T - 1/4P 1 45° ELBOW	 <b>20390</b> 26 3/16T - 1/8P 3 90° ELBOW	 <b>20391</b> 27 1/4T - 1/8P 3 90° ELBOW	 <b>20394</b> 28 5/16T - 1/4P 1 90° ELBOW	 <b>20396</b> 29 3/8T - 1/4P 1 90° ELBOW	 <b>20411</b> 30 1/4 TUBE 1 FORD NUT		

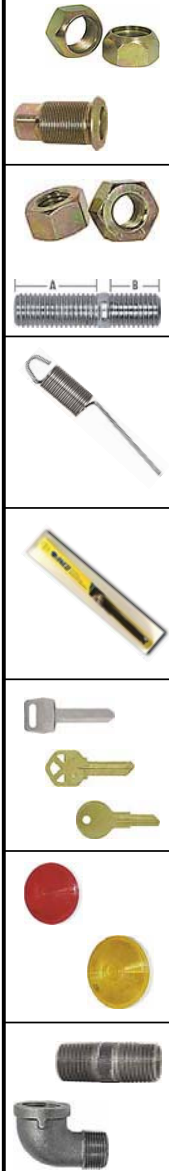















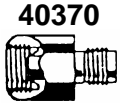
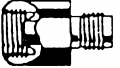





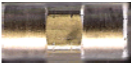
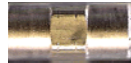
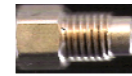
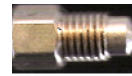
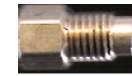





# J&B Fleet - Industrial Supply

22428 Harrisburg-Westville Rd. Alliance, Ohio 44601 Phone: (330) 821-6342 Fax: (330) 821-0411

[www.jbfleet.com](http://www.jbfleet.com)

PART # 2247

## BRAKE LINE ADAPTER KIT

 <p><b>40370</b> <sup>1</sup></p> <p>3/16" F - 1/4" M BRASS INV FLARE ADAPT</p> <p>2</p>	 <p><b>40371</b> <sup>2</sup></p> <p>3/16" F - 5/16" M BRASS INV FLARE ADAPT</p> <p>2</p>	 <p><b>40375</b> <sup>3</sup></p> <p>3/16" F - 9/16"-18 M BRASS INV FLARE ADAPT</p> <p>2</p>	 <p><b>40372</b> <sup>4</sup></p> <p>1/4" F - 3/16" M BRASS INV FLARE ADAPT</p> <p>2</p>	 <p><b>40374</b> <sup>5</sup></p> <p>1/4" F - 5/16" M BRASS INV FLARE ADAPT</p> <p>2</p>	 <p><b>40378</b> <sup>6</sup></p> <p>1/4" F - 9/16"-18 M BRASS INV FLARE ADAPT</p> <p>2</p>	 <p><b>40380</b> <sup>7</sup></p> <p>3/16" F - M10 X 1 EURO INV FLARE ADAPT</p> <p>2</p>	 <p><b>40381</b> <sup>8</sup></p> <p>3/16" F - M10 X 1 JAPANESE INV FLARE ADAPT</p> <p>2</p>
 <p><b>40384</b> <sup>9</sup></p> <p>M10 X 1.00 BUBBLE INV FLARE UNION</p> <p>2</p>	 <p><b>40385</b> <sup>10</sup></p> <p>M10 X 1.00 STANDARD INV FLARE UNION</p> <p>2</p>	 <p><b>40386</b> <sup>11</sup></p> <p>M11 X 1.50 BRAKE LINE ADAPT</p> <p>2</p>	 <p><b>40387</b> <sup>12</sup></p> <p>M12 X 1.00 BRAKE LINE ADAPT</p> <p>2</p>	 <p><b>40388</b> <sup>13</sup></p> <p>M13 X 1.50 BRAKE LINE ADAPT</p> <p>2</p>	 <p><b>40382</b> <sup>14</sup></p> <p>3/16" M10 X 1 EURO/DOMESTIC TUBE NUT</p> <p>2</p>	 <p><b>40383</b> <sup>15</sup></p> <p>3/16" M10 X 1 JAPANESE TUBE NUT</p> <p>2</p>	 <p><b>40389</b> <sup>16</sup></p> <p>3/16" M10 X 1 TOYOTA, GM LONG NUT</p> <p>2</p>
 <p><b>20378</b> <sup>17</sup></p> <p>3/16" STEEL TUBE NUT</p> <p>2</p>	 <p><b>20379</b> <sup>18</sup></p> <p>1/4" STEEL TUBE NUT</p> <p>2</p>	 <p><b>20380</b> <sup>19</sup></p> <p>5/16" STEEL TUBE NUT</p> <p>2</p>	 <p><b>20381</b> <sup>20</sup></p> <p>3/8" STEEL TUBE NUT</p> <p>2</p>	<p><sup>21</sup></p>	<p><sup>22</sup></p>	<p><sup>23</sup></p>	<p><sup>24</sup></p>
 <p><b>20292</b> <sup>25</sup></p> <p>3/16" BRASS COMPRESSION UNION</p> <p>2</p>	 <p><b>20293</b> <sup>26</sup></p> <p>1/4" BRASS COMPRESSION UNION</p> <p>2</p>	 <p><b>20294</b> <sup>27</sup></p> <p>5/16" BRASS COMPRESSION UNION</p> <p>2</p>	 <p><b>20295</b> <sup>28</sup></p> <p>3/8" BRASS COMPRESSION UNION</p> <p>2</p>	 <p><b>20399</b> <sup>29</sup></p> <p>3/16" BRASS INV FLARE UNION</p> <p>2</p>	 <p><b>20400</b> <sup>30</sup></p> <p>1/4" BRASS INV FLARE UNION</p> <p>2</p>	 <p><b>20401</b> <sup>31</sup></p> <p>5/16" BRASS INV FLARE UNION</p> <p>2</p>	 <p><b>20402</b> <sup>32</sup></p> <p>3/8" BRASS INV FLARE UNION</p> <p>2</p>





# J&B Fleet - Industrial Supply

22428 Harrisburg-Westville Rd. Alliance, Ohio 44601 Phone: (330) 821-6342 Fax: (330) 821-0411

www.jbfleet.com

PART # 2251

## BRAKE & FUEL LINE TUBE NUTS

 <b>20378</b> 1 3/16" I/F NUT 2	 <b>20379</b> 2 1/4" I/F NUT 2	 <b>20380</b> 3 5/16" I/F NUT 2	 <b>42378</b> 4 3/16" I/F LONG NUT 2	 <b>42379</b> 5 1/4" I/F LONG NUT 2	 <b>20399</b> 6 3/16" I/F UNION 2	 <b>20400</b> 7 1/4" I/F UNION 2	 <b>20401</b> 8 5/16" I/F UNION 2
 <b>42377</b> 9 (7/16 HEX) 3/16" VIOLET NUT 2	 <b>42350</b> 10 3/16" 7/16-24 OVERSIZE NUT 2	 <b>42351</b> 11 3/16" 1/2-20 OVERSIZE NUT 2	 <b>42352</b> 12 3/16" 9/16-18 OVERSIZE NUT 2	 <b>42353</b> 13 1/4" 9/16-18 OVERSIZE NUT 2	 <b>42354</b> 14 1/4" 1/2-20 OVERSIZE NUT 2	 <b>40384</b> 15 3/16" M10-1.00 BUBBLE FLARE UNION 2	 <b>40385</b> 16 3/16" M10-1.00 I/F UNION 2
 <b>40382</b> 17 3/16" M10-1.00 BUBBLE FLARE 2	 <b>42369</b> 18 3/16" M10-1.00 BUBBLE FLARE 2	 <b>42362</b> 19 3/16" M11-1.50 BUBBLE FLARE 2	 <b>42363</b> 20 3/16" M12-1.00 BUBBLE FLARE 2	 <b>42364</b> 21 3/16" M13-1.50 BUBBLE FLARE 2	 <b>40380</b> 22 3/16" M10-1.00 BUBBLE CONV ADAPTER 2	 <b>40381</b> 23 3/16" M10-1.00 I/F CONV ADAPTER 2	 <b>40386</b> 24 3/16" M10-1.50 BUBBLE CONV ADAPTER 2
 <b>40383</b> 25 3/16" M10-1.00 I/F NUT 2	 <b>42358</b> 26 3/16" M10-1.00 I/F NUT 2	 <b>42359</b> 27 1/4" M12-1.00 I/F NUT 2	 <b>40389</b> 28 3/16" M10-1.00 I/F NUT 2	 <b>42360</b> 29 3/16" M10-1.00 I/F NUT 2	 <b>40387</b> 30 3/16" M12-1.00 BUBBLE CONV ADAPTER 2	 <b>40388</b> 31 3/16" M13-1.50 BUBBLE CONV ADAPTER 2	 <b>42374</b> 32 3/8" M16-1.50  <b>42375</b> 5/16" M14-1.50 2

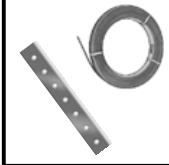



LET US HELP YOU MAKE THE CONNECTION

PART # 3031

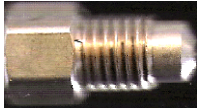

# BRAKELINE ADAPTERS



J & B FLEET-INDUSTRIAL SUPPLY  
PHONE: 330-821-6342

<p><b>40380</b></p> <p>3/16- M10 X 1" EUROPEAN</p> <p>2</p>	<p><b>40381</b></p> <p>3/16- M10 X 1" JAPANESE</p> <p>2</p>	<p><b>40382</b></p> <p>METRIC BLUE LINE NUT</p> <p>2</p>	<p><b>40383</b></p> <p>METRIC PURPLE LINE NUT</p> <p>2</p>		
<p><b>40384</b></p> <p>METRIC BUBBLE UNION M10 X 1.0</p> <p>2</p>	<p><b>40385</b></p> <p>METRIC INVERTED FLARE M10 X 1.0</p> <p>2</p>	<p><b>40386</b></p> <p>METRIC M11 X 1.5</p> <p>2</p>	<p><b>40387</b></p> <p>METRIC M12 X 1.0</p> <p>2</p>	<p><b>40388</b></p> <p>METRIC M13 X 1.5</p> <p>2</p>	
<p><b>40370</b></p> <p>3/16 F - 1/4 M</p> <p>2</p>	<p><b>40371</b></p> <p>3/16 F - 5/16 M</p> <p>2</p>	<p><b>40375</b></p> <p>3/16 F - 9/16-18 M</p> <p>2</p>	<p><b>40372</b></p> <p>1/4 F - 3/16 M</p> <p>2</p>	<p><b>40374</b></p> <p>1/4 F - 5/16 M</p> <p>2</p>	<p><b>40378</b></p> <p>1/4 F—9/16-18 M</p> <p>2</p>

LET US HELP YOU MAKE THE CONNECTION

PART # 3080

# BRAKE LINE FITTINGS



J & B FLEET-INDUSTRIAL SUPPLY  
PHONE: 330-821-6342

<b>42350</b>  <b>3/16 RED OVERSIZED TUBE NUT</b>  2	<b>42351</b>  <b>3/16 GREEN OVERSIZED TUBE NUT</b>  2	<b>42352</b>  <b>3/16 OLIVE OVERSIZED TUBE NUT</b>  2	<b>42353</b>  <b>1/4 BLUE OVERSIZED TUBE NUT</b>  2	<b>42354</b>  <b>1/4 SILVER OVERSIZED TUBE NUT</b>  2	
<b>40382</b>  <b>3/16 M10 X 1.00 OLIVE TUBE NUT</b>  2	<b>42362</b>  <b>3/16 M11 X 1.50 ORANGE TUBE NUT</b>  2	<b>42363</b>  <b>3/16 M12 X 1.00 BLUE TUBE NUT</b>  2	<b>42364</b>  <b>3/16 M13 X 1.50 GREEN TUBE NUT</b>  2		

LET US HELP YOU MAKE THE CONNECTION

Part # 3081

# BRAKE LINE FITTINGS & ADAPTERS



J & B FLEET-INDUSTRIAL SUPPLY  
PHONE: 330-821-6342

<p><b>40382</b></p> <p><b>3/16"</b> <b>OLIVE</b> <b>STEEL TUBE</b> <b>NUT</b></p> <p>2</p>	<p><b>40380</b></p> <p><b>3/16" F x M10 M</b></p> <p><b>BRASS</b> <b>CONVERSION</b> <b>INVERTED</b> <b>FLARE ADAPTER</b></p> <p>2</p>	<p><b>42362</b></p> <p><b>3/16"</b> <b>ORANGE</b></p> <p><b>BRASS TUBE</b> <b>NUT</b></p> <p>2</p>	<p><b>42363</b></p> <p><b>3/16"</b> <b>BLUE</b></p> <p><b>BRASS TUBE</b> <b>NUT</b></p> <p>2</p>	<p><b>42364</b></p> <p><b>3/16"</b> <b>GREEN</b></p> <p><b>BRASS TUBE</b> <b>NUT</b></p> <p>2</p>	<p><b>42369</b></p> <p><b>3/16"</b> <b>GOLD</b></p> <p><b>BRASS TUBE</b> <b>NUT</b></p> <p>2</p>
<p><b>40383</b></p> <p><b>3/16"</b> <b>BLUE</b></p> <p><b>STEEL TUBE</b> <b>NUT</b></p> <p>2</p>	<p><b>40384</b></p> <p><b>M10 X 1.00</b></p> <p><b>METRIC</b> <b>BUBBLE</b> <b>UNION</b></p> <p>2</p>	<p><b>40381</b></p> <p><b>3/16" F x M10 M</b></p> <p><b>BRASS</b> <b>CONVERSION</b> <b>INVERTED</b> <b>FLARE ADAPTER</b></p> <p>2</p>	<p><b>40385</b></p> <p><b>M10 X 1.00</b></p> <p><b>STANDARD</b> <b>INVERTED</b> <b>FLARE</b> <b>METRIC UNION</b></p> <p>2</p>		