

Monday

Song for the letter of the week.

AAAAAAAAAAAAAAAAAAAAAAAAAAAAAAAAAAAAAAAA

Apple Annie

TUNE: JINGLE BELLS

**Apple Annie, Apple Annie, how are you today?
Tell me all the things you know about the letter A.
Alligators, astronauts, apple trees that sway;
These are all my favorite things
That start with letter A.**

The End

1
AAAAAAAAAAAAAAAAAAAAAAAAAAAAAAAA

AA

Tuesday

Letter activity sheet

A IS FOR APPLE

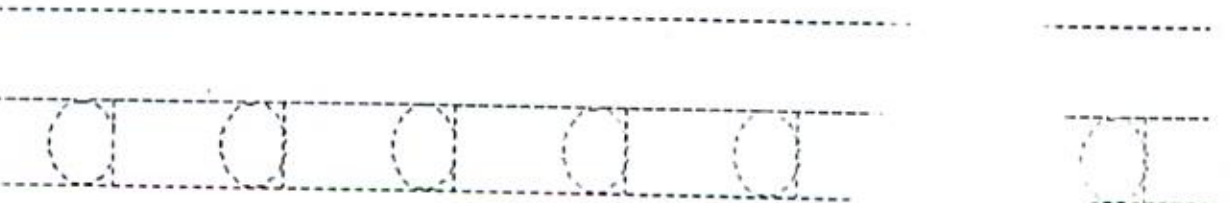
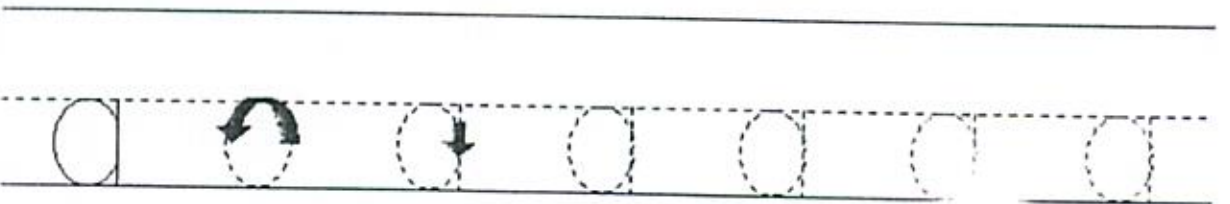
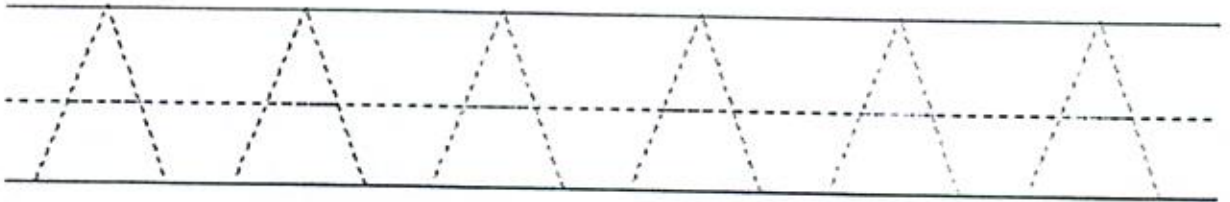
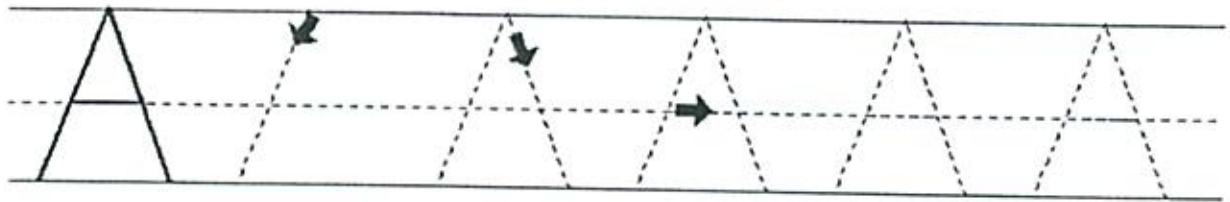

Wednesday

Color Sheet

Aa

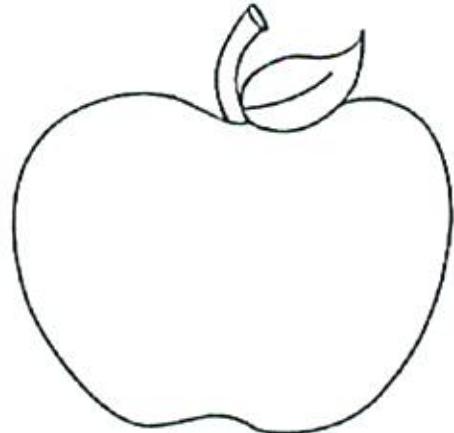

Apple

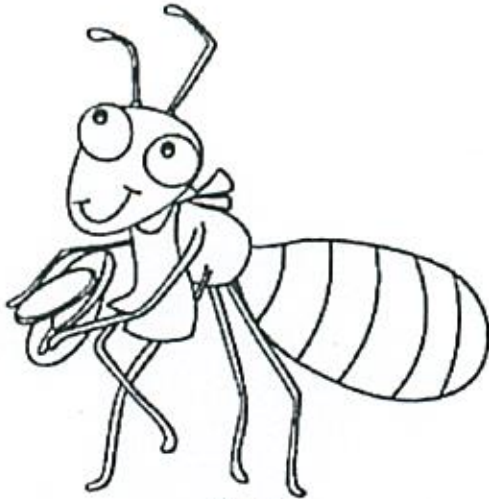

Ant



Archer



Alligator



Airplane

Thursday

Art Activity

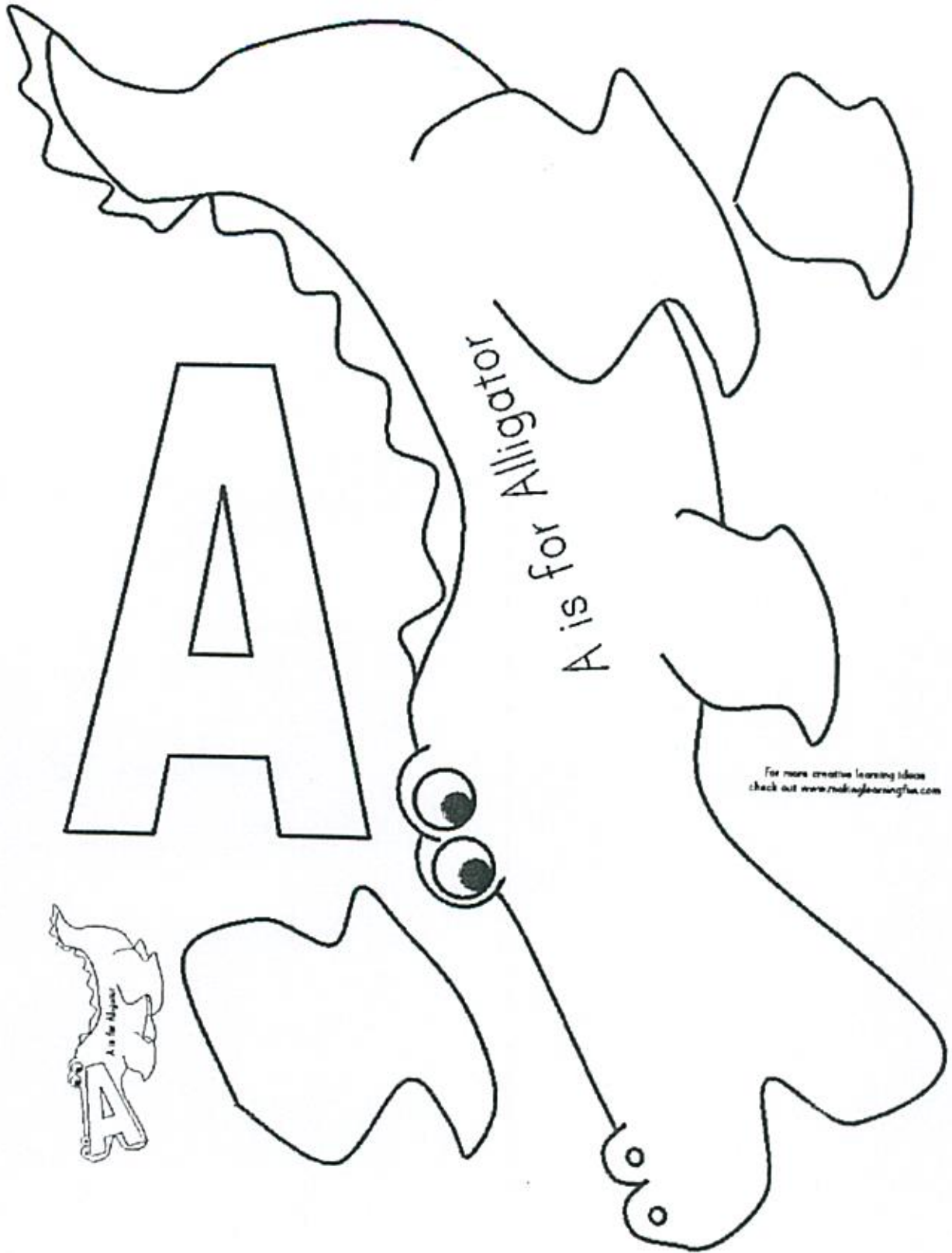

For more creative learning ideas
check out www.makinglearningfun.com

Friday

Name writing sheet

(Let the child write his/her name at the top and then on Saturday and Sunday let them write their name again)

**L.B.J. & C. Head Start
Children's Sign-in for Home**

Name:

Saturday:

Sunday:

Monday

Song for the letter of the week.

BBBBBBBBBBBBBBBBBBBBBBBBBBBBBBBBBBBBBBBBBBBBBBBBBBBBBBBB

Benjamin Bunny

TUNE: BEAUTIFUL DREAMER

Benjamin Bunny,
What do you see?
Name all the things
That begin with a B.
Babies and bubbles,
Butterflies too,
Beachballs and bears
And balloons that are blue.
The End



BBBBBBBBBBBBBBBBBBBBBBBBBBBBBBBBBBBBBBBBBBBBBBBBBBBB

BBBBBB

Tuesday

Letter activity sheet

B IS FOR BUMBLEBEE

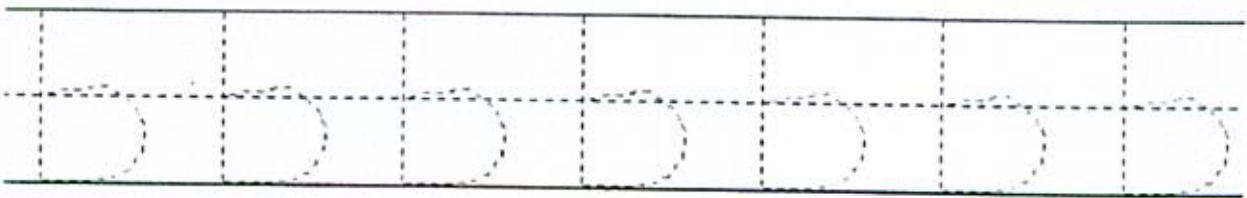
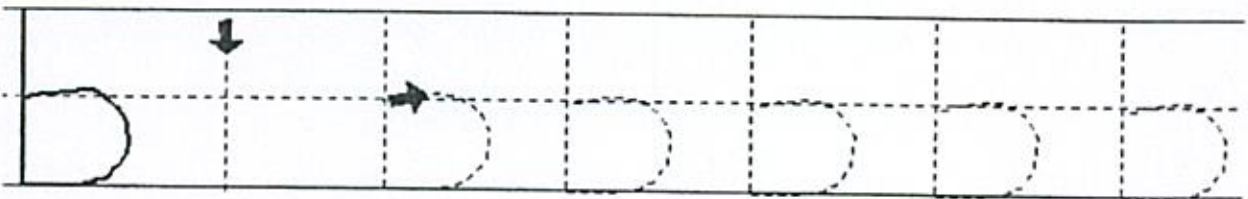
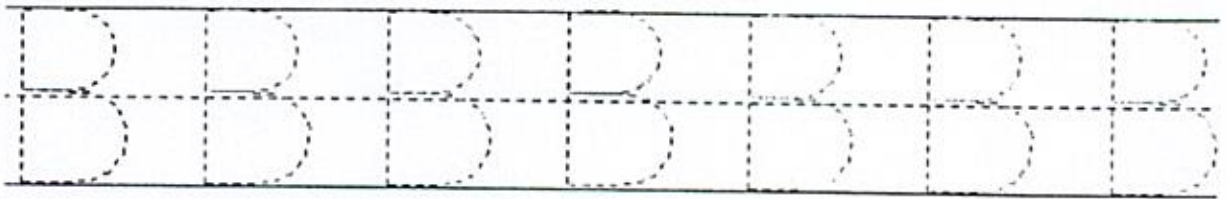
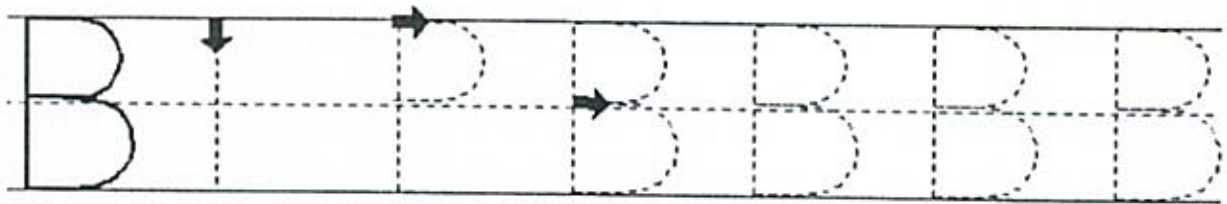

Wednesday

Color Sheet

Bb

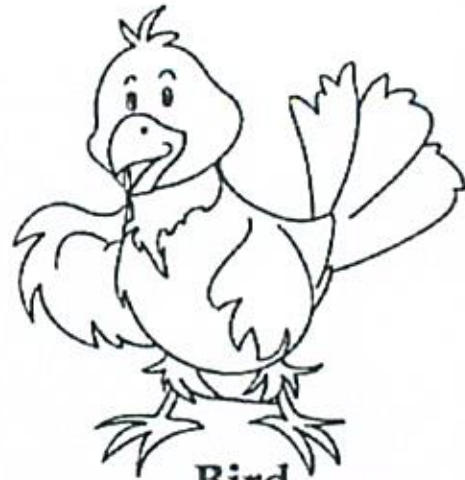

Bird

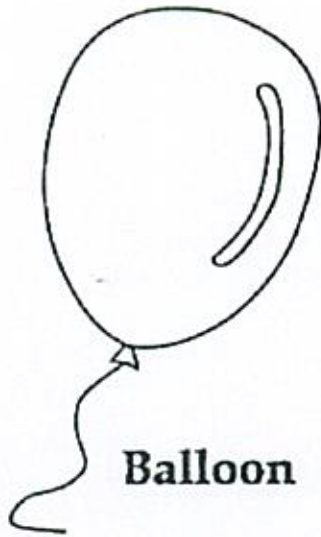

Balloon

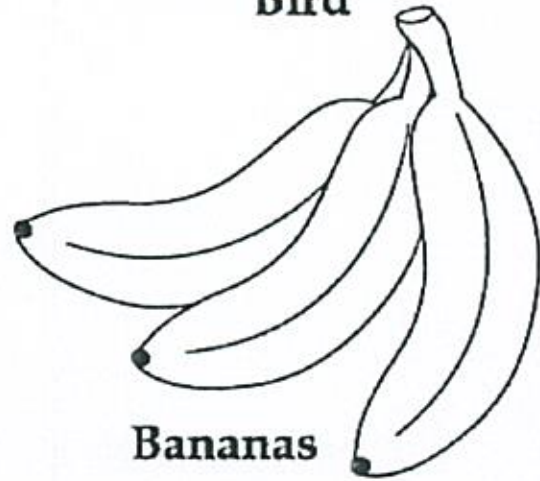

Bananas

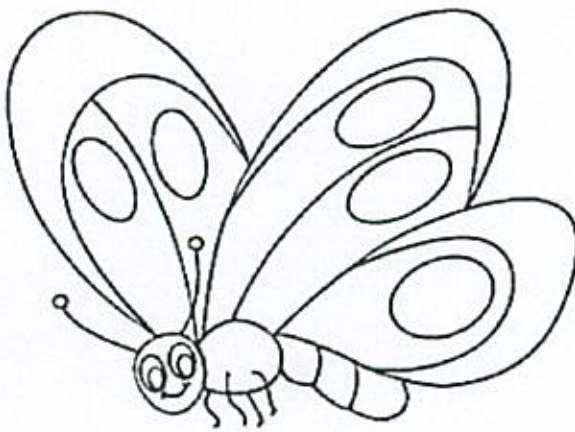

Butterfly



Bear

Thursday

Art Activity

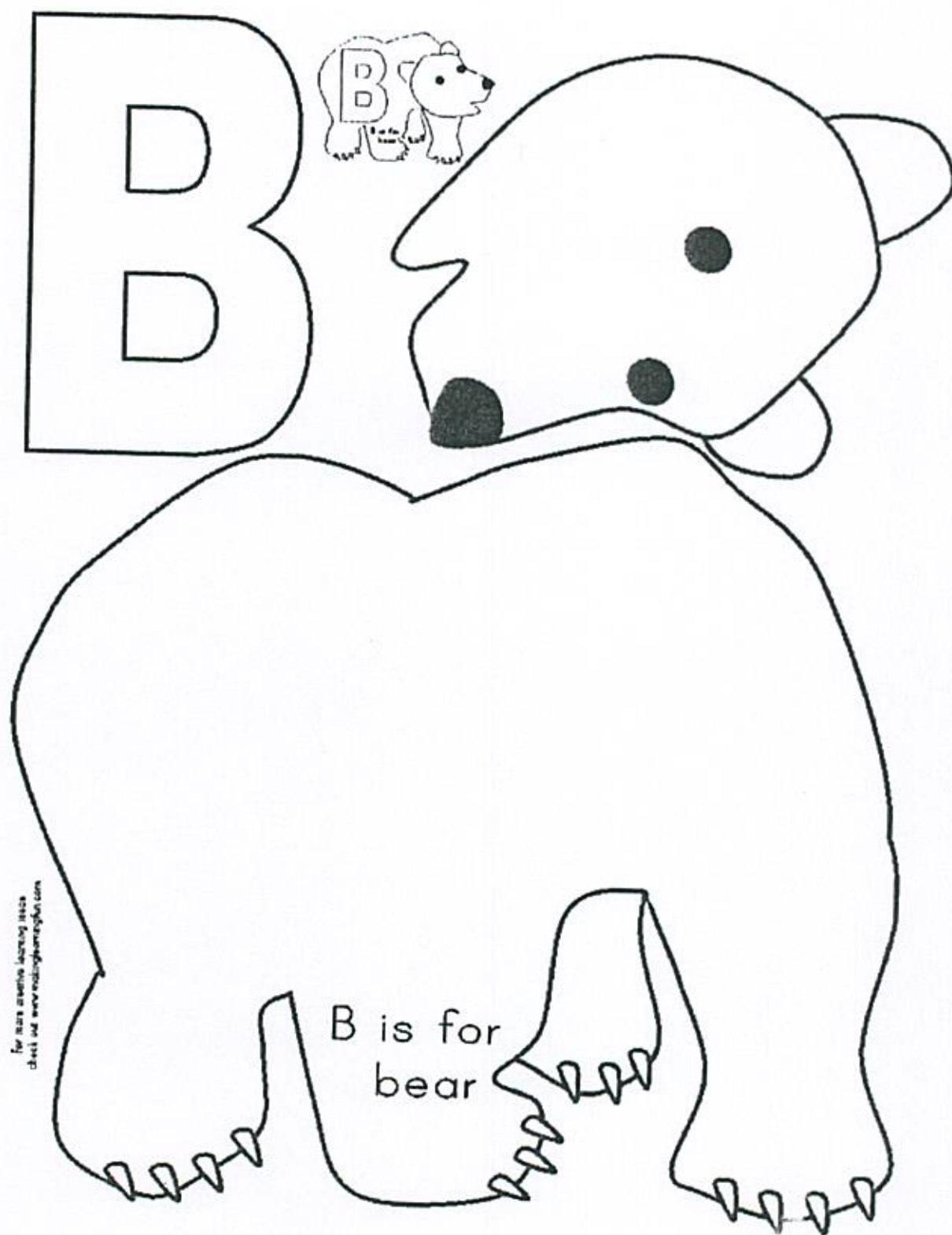

For more creative learning ideas
check out www.makinglearningfun.com

Friday

Name writing sheet

(Let the child write his/her name at the top and then on Saturday and Sunday let them write their name again)

**L.B.J. & C. Head Start
Children's Sign-in for Home**

Name:

Saturday:

Sunday:

Monday

Song for the letter of the week.

CCCCCCCCCCCCCCCCCCCCCCCCCCCCCCCCCCCCCCCC

CATHY COOK

TUNE: THE FARMER IN THE DELL

Good morning Cathy Cook,
Make something good for me.
There are lots of yummy things
That start with letter Cc.
Cookies, candy canes,
Cupcakes and a coke,
Carrots, corn and cauliflower
Almost make me croak.

The End



CCCCCCCCCCCCCCCCCCCCCCCCCCCCCCCCCCCCCCCC

Tuesday

Letter activity sheet

C IS FOR CAR

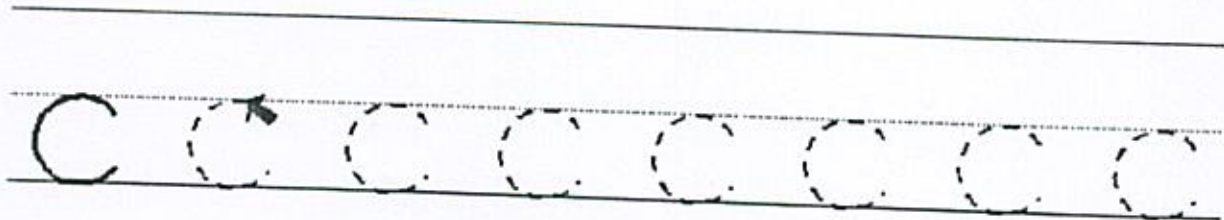
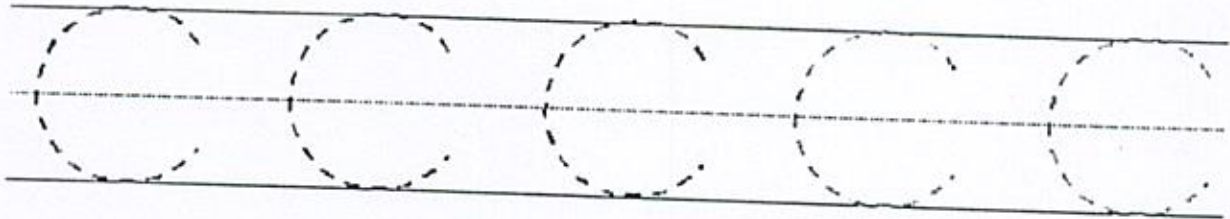
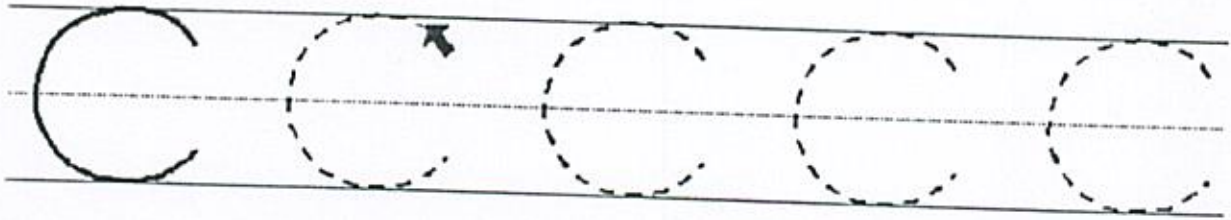
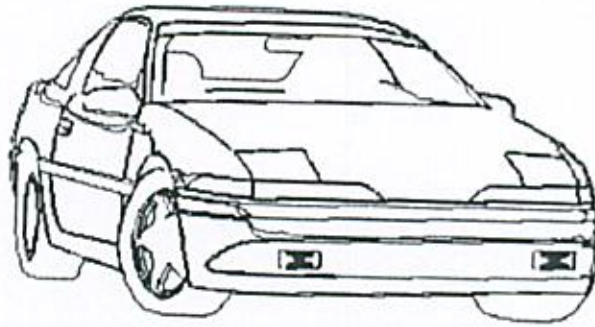

Wednesday

Color Sheet

Cc



Cow

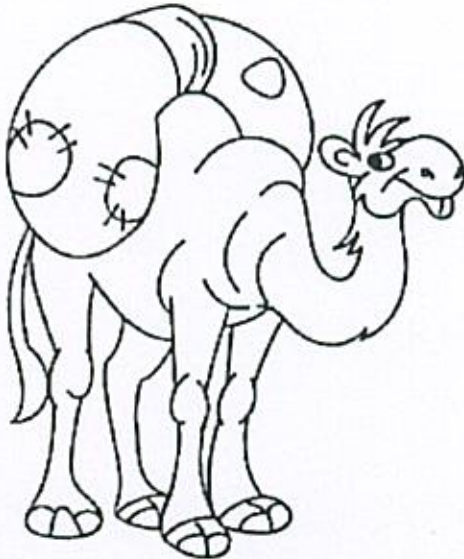

Camel



Cat

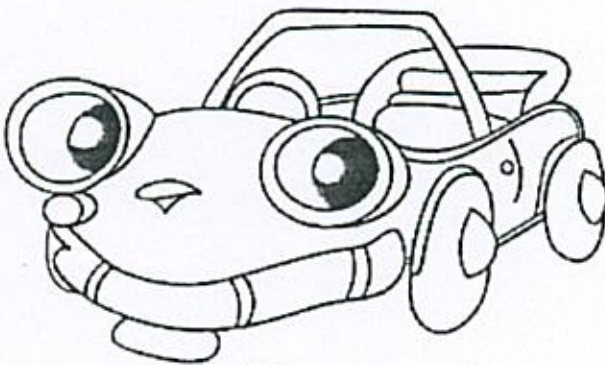

Car

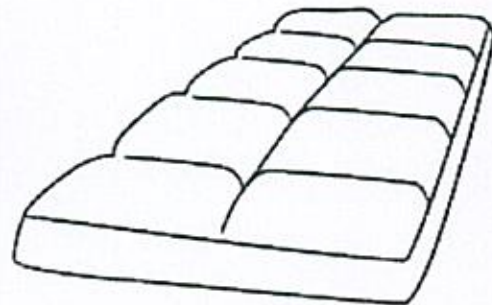

Chocolate

Thursday

Art Activity

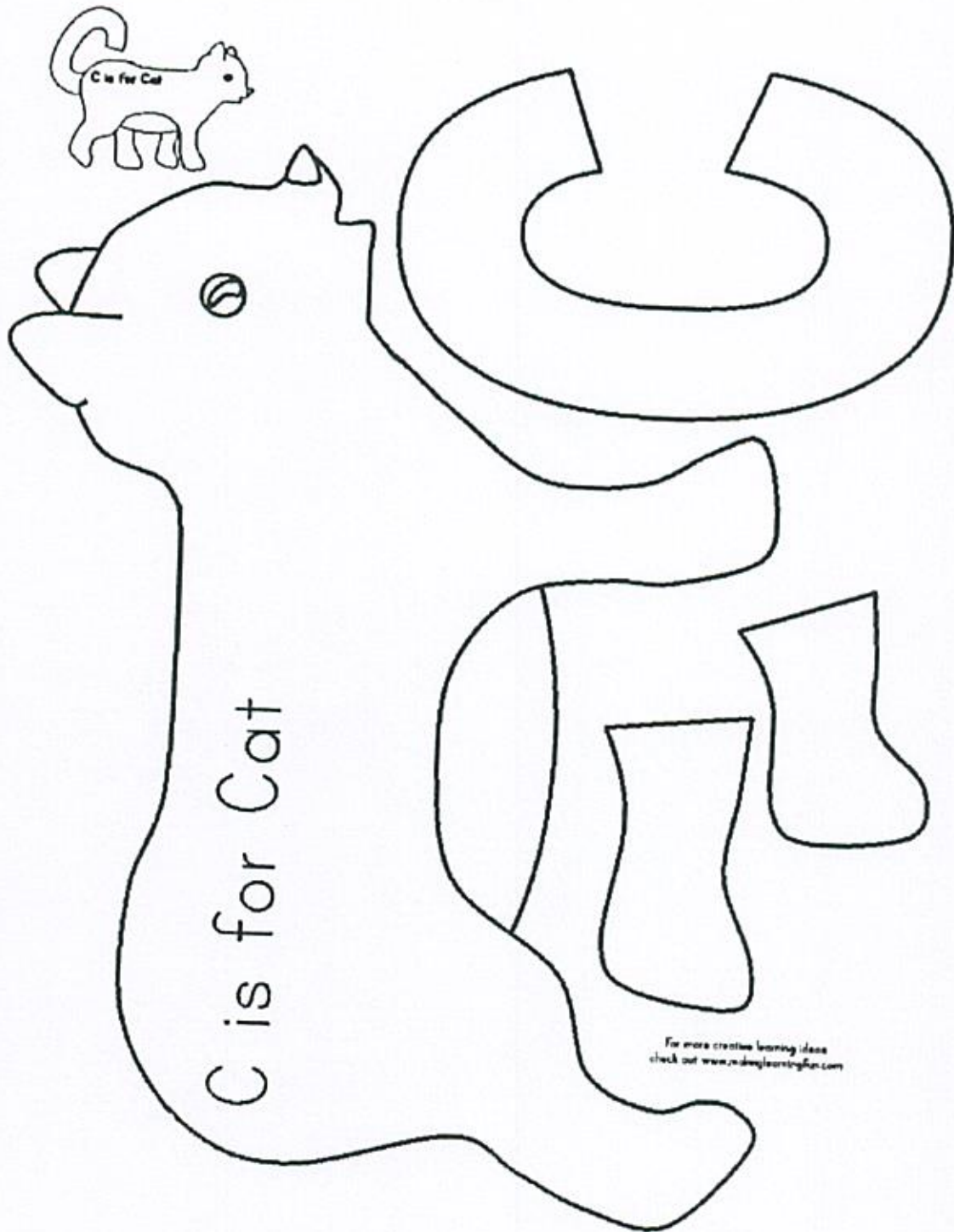

For more creative learning ideas
check out www.makinglearningfun.com

Friday

Name writing sheet

(Let the child write his/her name at the top and then on
Saturday and Sunday let them write their name again)

**L.B.J. & C. Head Start
Children's Sign-in for Home**

Name:

Saturday:

Sunday:

Monday

Song for the letter of the week.

DDDDDDDDDDDDDDDDDDDDDDDDDDDDDDDDDDDDDDDDDDDDDDDDDD

Daisy Doll

TUNE: JINGLE BELLS

Daisy Doll, Daisy Doll,
Tell us what you see.

Name the things around your house
That start with letter D.
Daffodils, dandelions,
Dogs that dig in dirt,
Daddy working in the yard
In his favorite shirt.

The End



DDDDDDDDDDDDDDDDDDDDDDDDDDDDDDDDDDDDDDDDDDDDDDDDDD

DDDDDD

Tuesday

Letter activity sheet

D IS FOR DINOSAUR

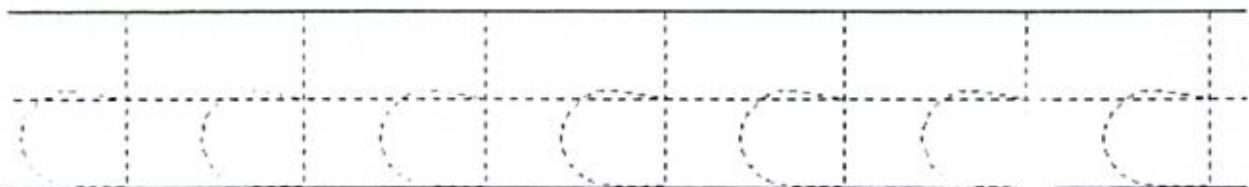
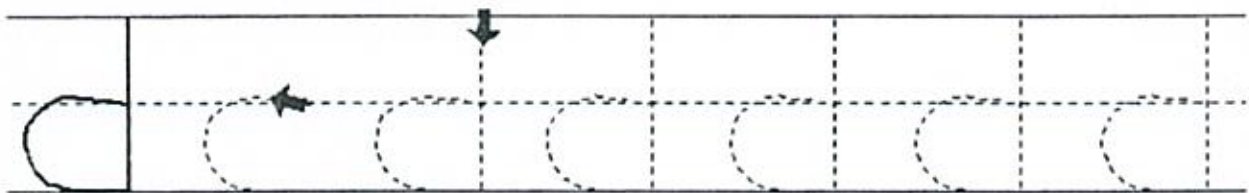
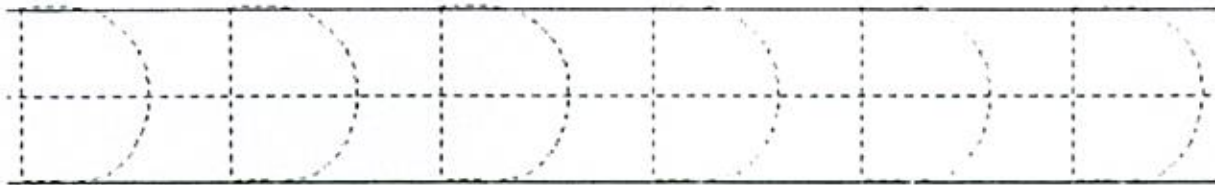
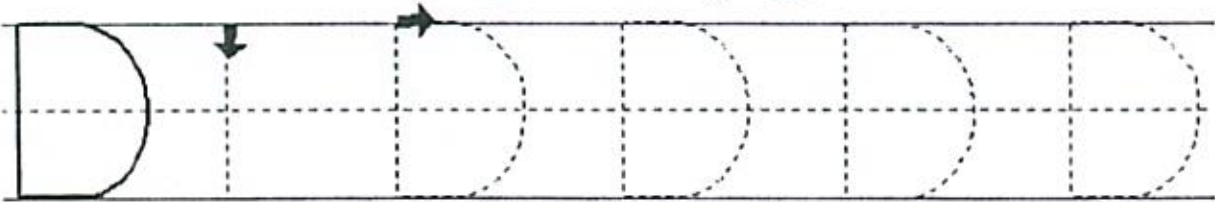
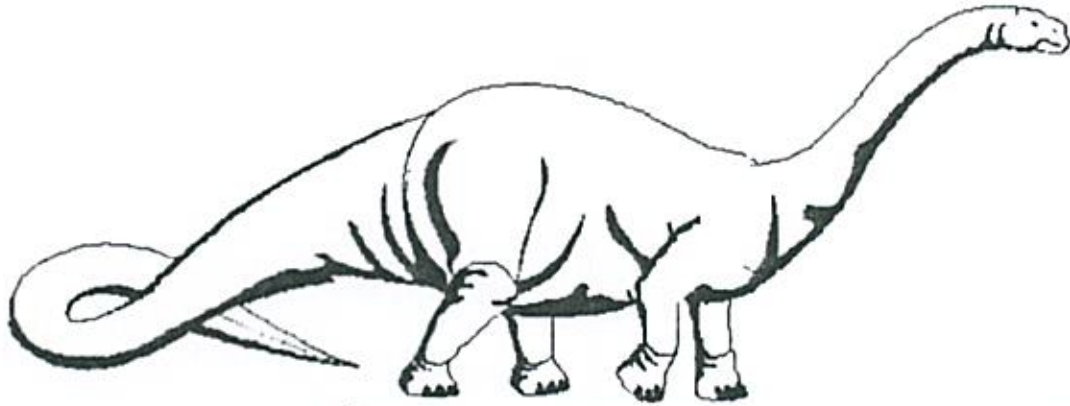

Wednesday

Color Sheet

Dd



Dog



Dolphin

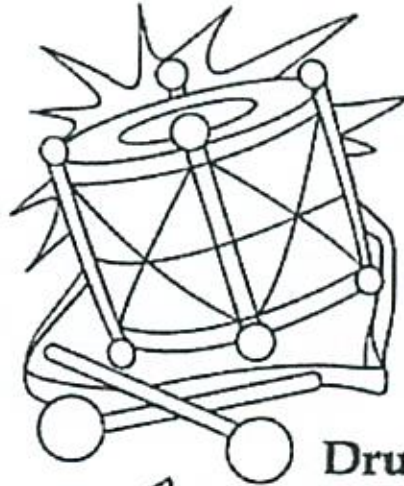

Drum



Duck



Deer

Thursday

Art Activity

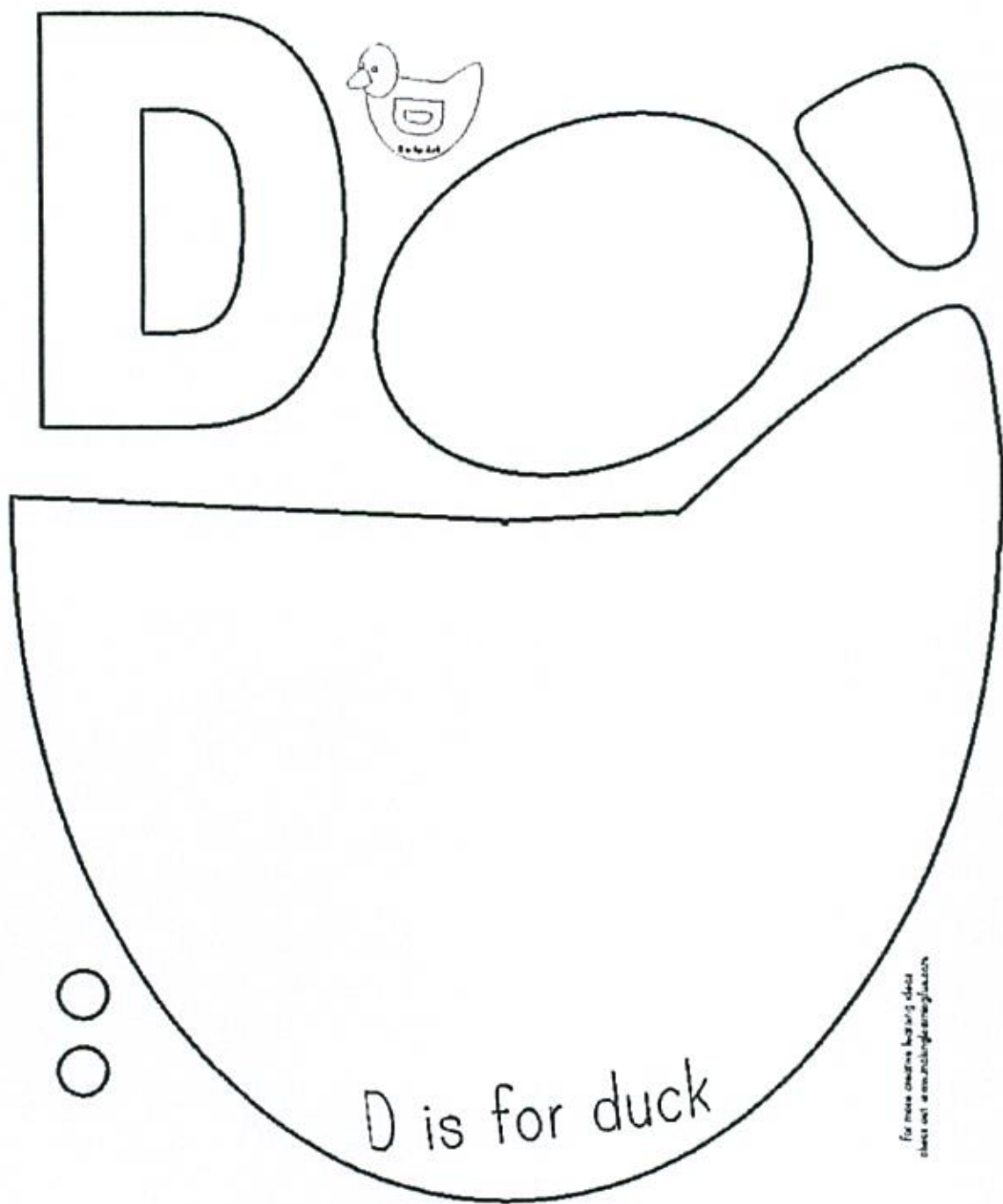

Friday

Name writing sheet

(Let the child write his/her name at the top and then on Saturday and Sunday let them write their name again)

**L.B.J. & C. Head Start
Children's Sign-in for Home**

Name:

Saturday:

Sunday:

Monday

Song for the letter of the week.

Tuesday

Letter activity sheet

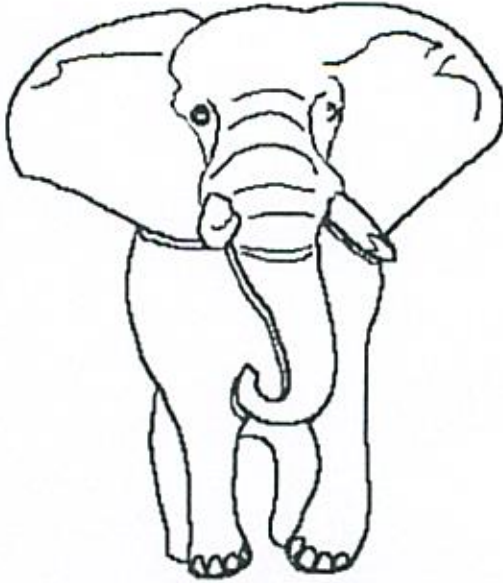

E IS FOR
ELEPHANT

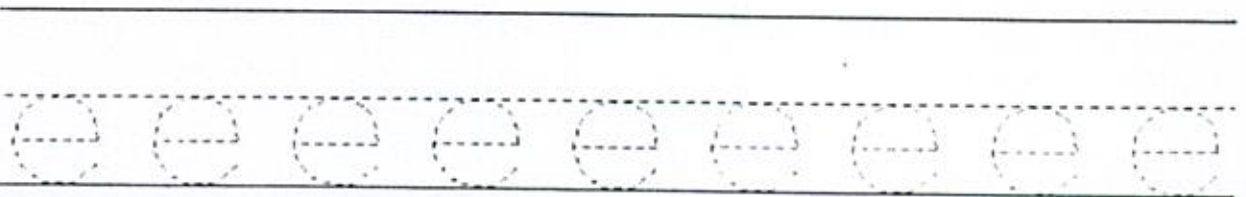
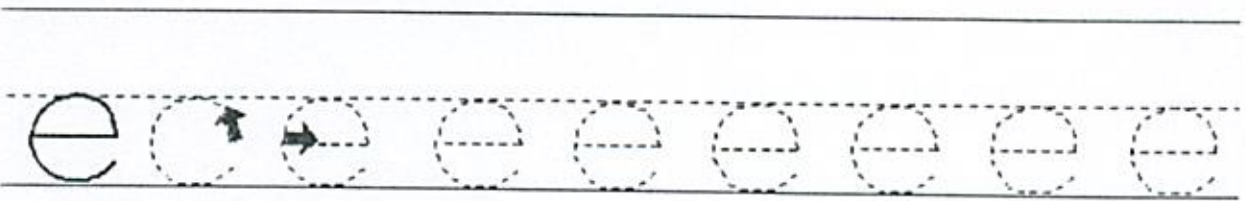
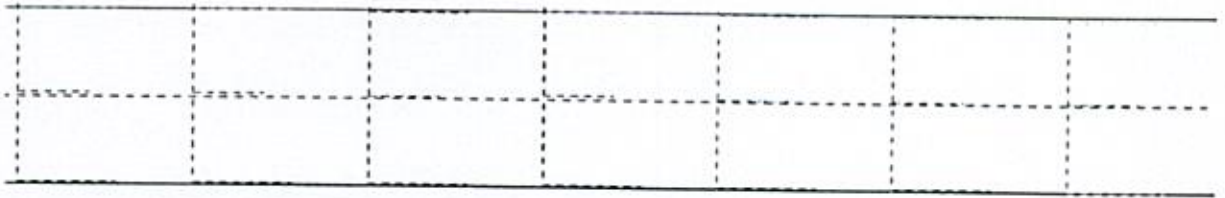
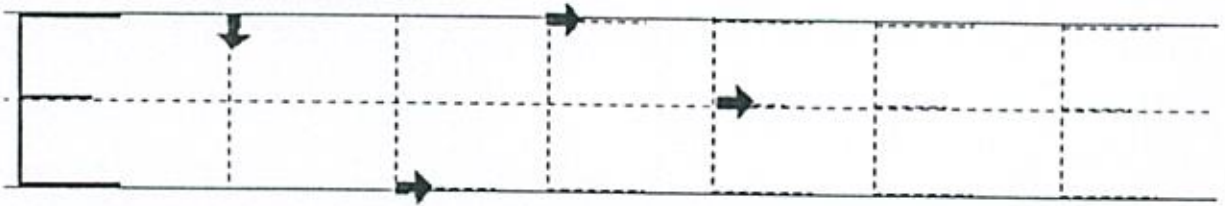

Wednesday

Color Sheet

Ee

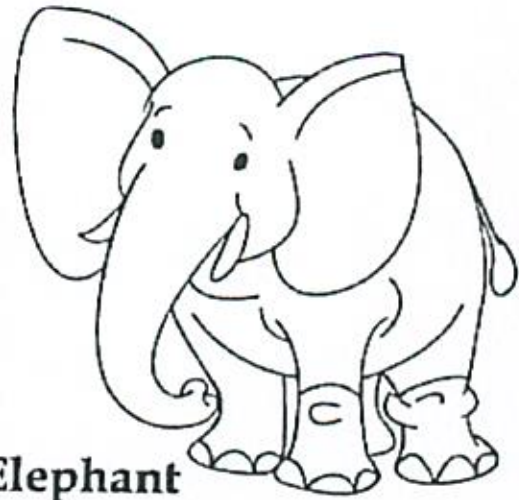

Elephant

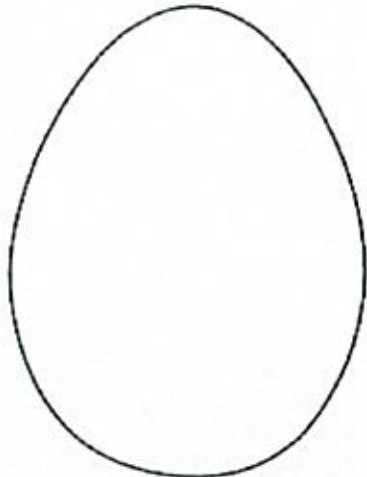

Egg

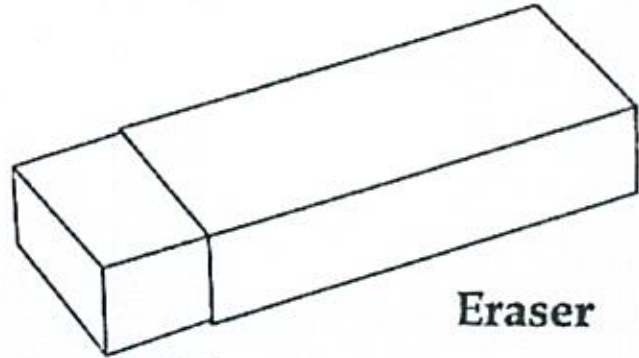

Eraser



Earth



Engine

Thursday

Art Activity

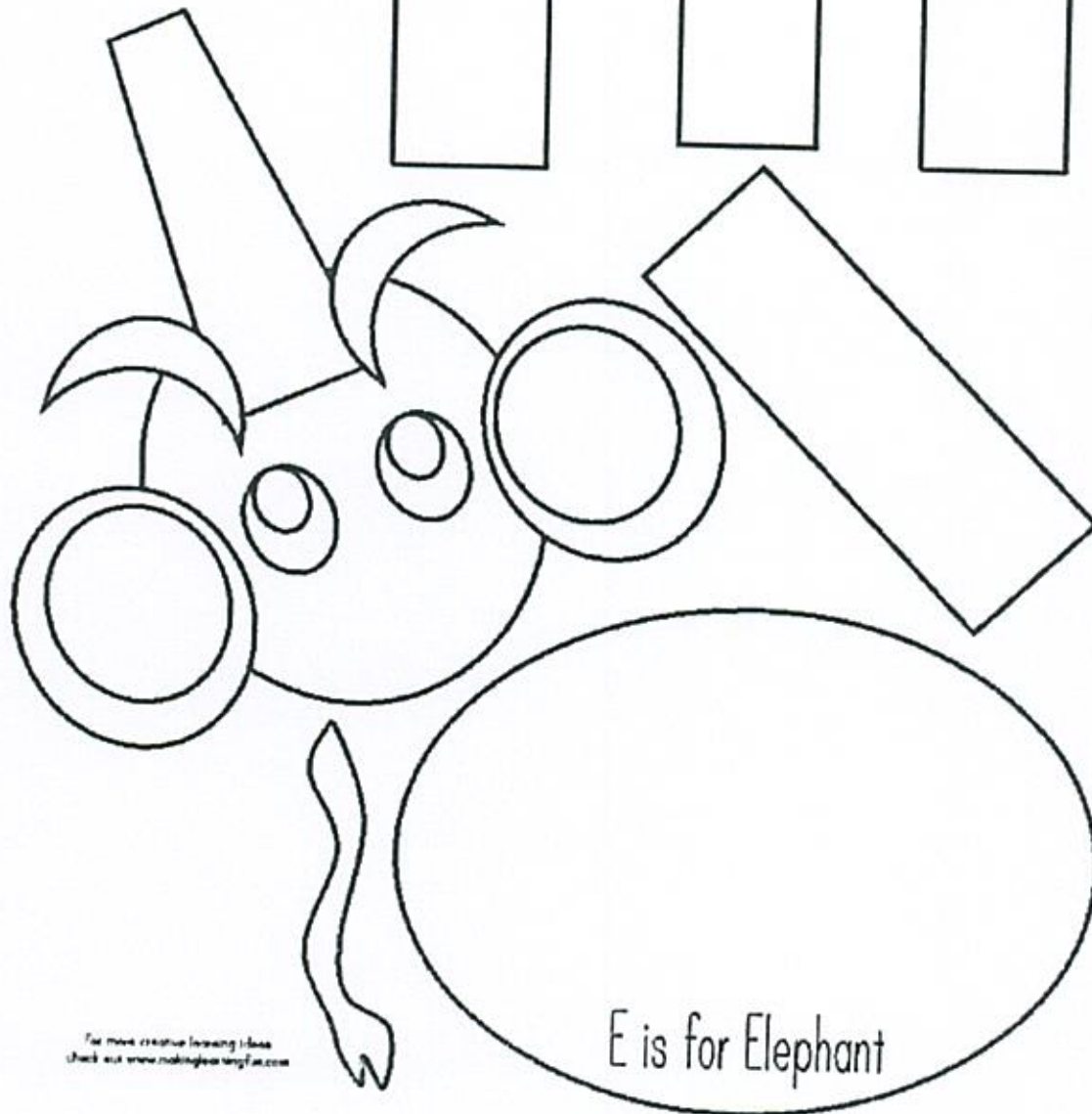
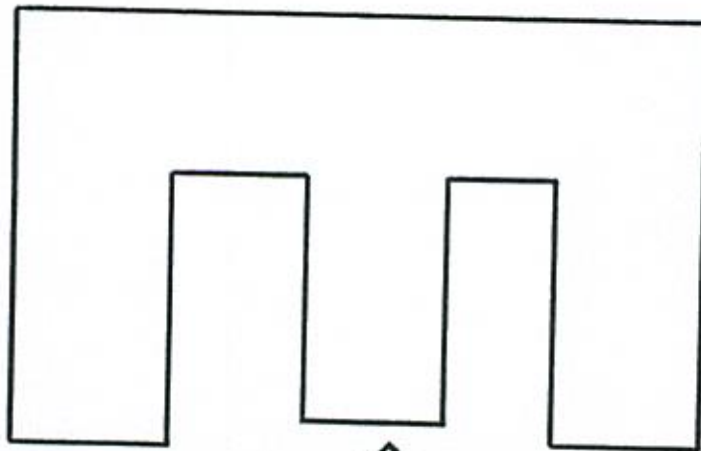
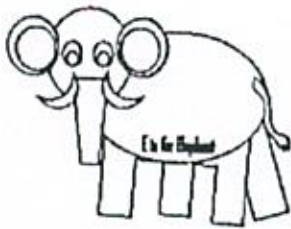

For more creative learning ideas
check out www.makinglearningfun.com

Friday

Name writing sheet

(Let the child write his/her name at the top and then on Saturday and Sunday let them write their name again)

**L.B.J. & C. Head Start
Children's Sign-in for Home**

Name:

Saturday:

Sunday:

Monday

Song for the letter of the week.

XXXXXXXXXXXXXXXXXXXXXXXXXXXXXXXXXXXXXXXXXXXXXXXXXXXX



Foxy Roxy

TUNE: TWINKLE TWINKLE LITTLE STAR

Foxy Roxy was a fox,
Who lived in a paper box.
She collected rocks and clocks,
Kept them in her dirty socks.
She played on her xylophone,
Until she began to moan.
Roxy had some itchy spots,
So she called on Dr. Cox.
Dr. Cox was in dismay.
We must take a quick X-ray.
Dr. Cox, the wise old ox
Cried "Oh, no! It's chicken-pox".
The End

XXXXXXXXXXXXXXXXXXXXXXXXXXXXXXXXXXXXXXXXXXXXXXXXXXXX

Tuesday

Letter activity sheet

F IS FOR FIRE TRUCK

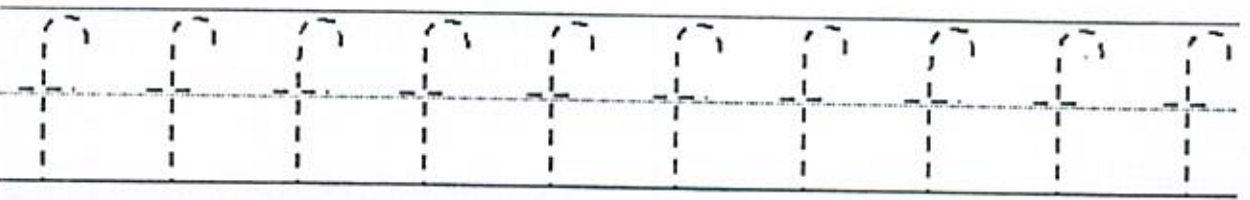
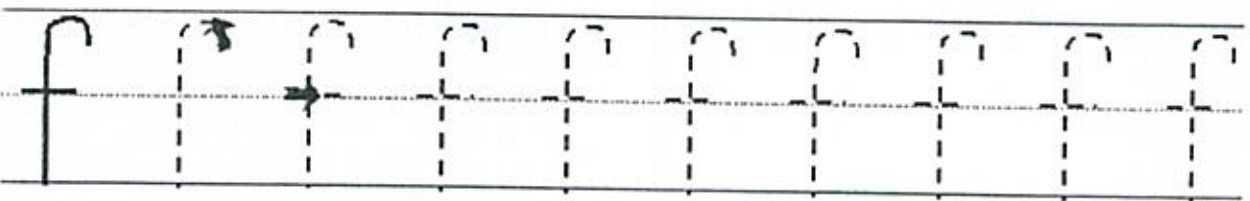
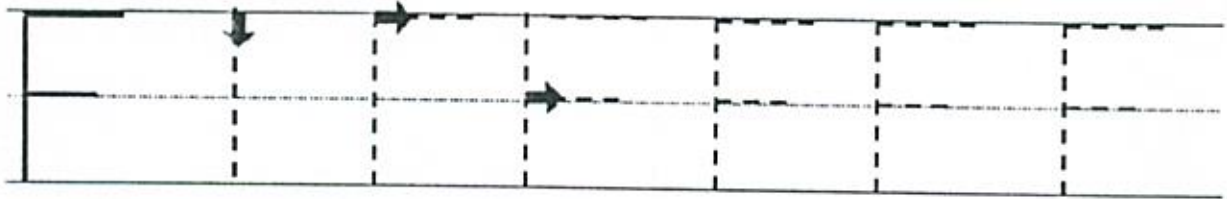
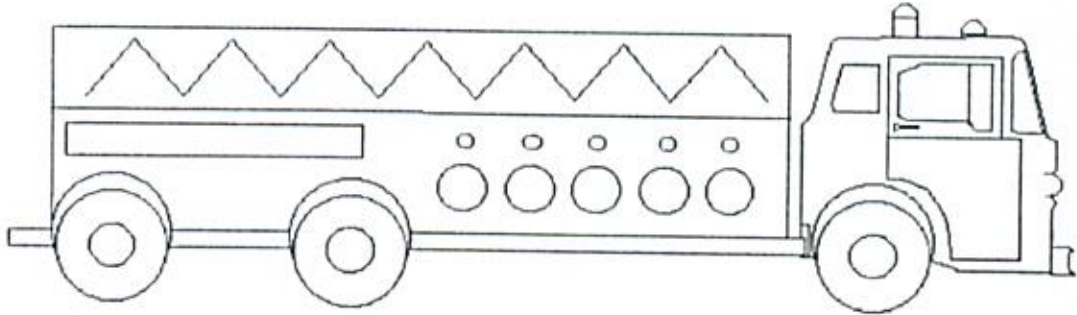

Wednesday

Color Sheet

Ff

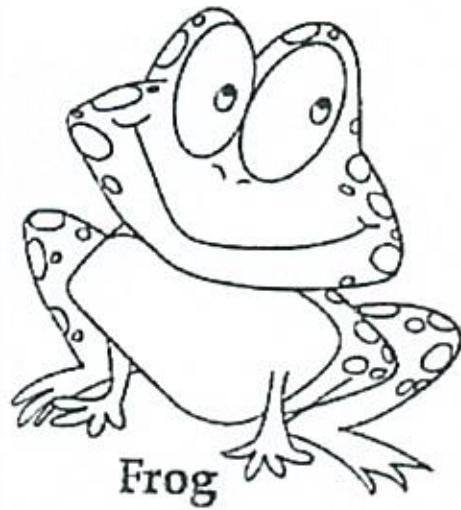
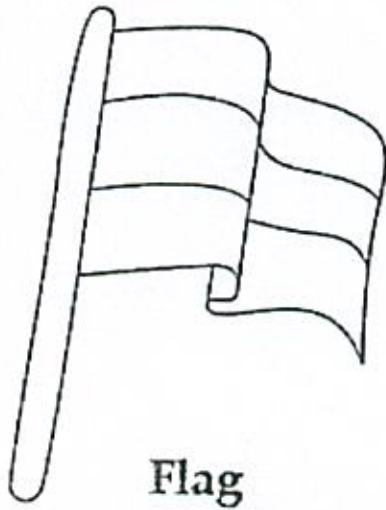

Thursday

Art Activity

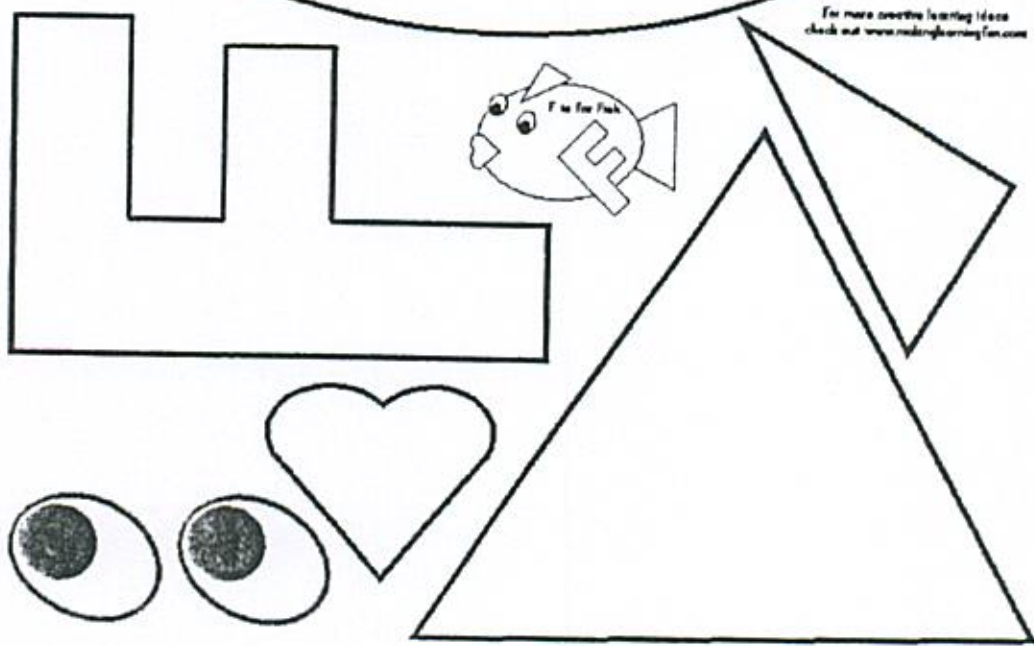
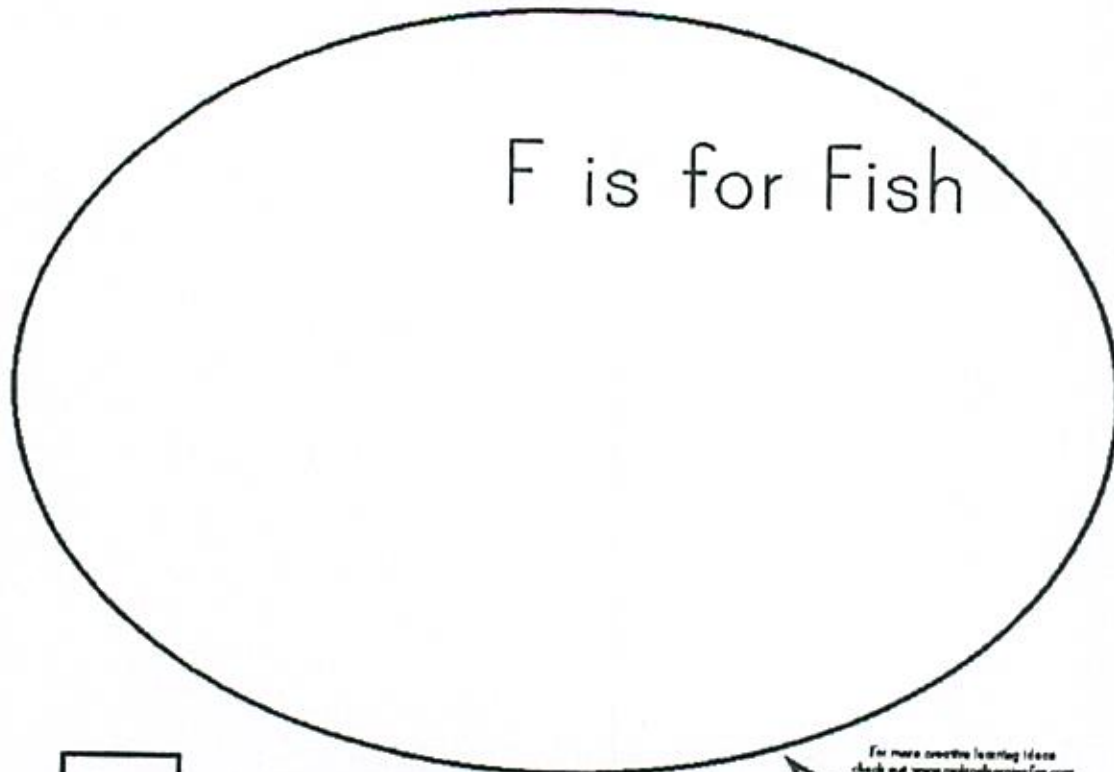

Friday

Name writing sheet

(Let the child write his/her name at the top and then on Saturday and Sunday let them write their name again)

**L.B.J. & C. Head Start
Children's Sign-in for Home**

Name:

Saturday:

Sunday:

Monday

Song for the letter of the week.

Tuesday

Letter activity sheet

G IS FOR
GHOST

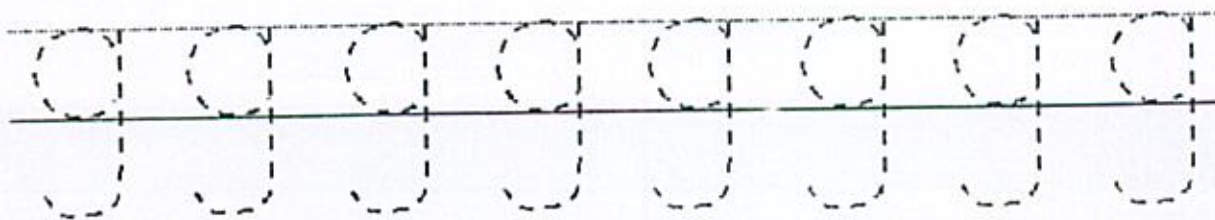
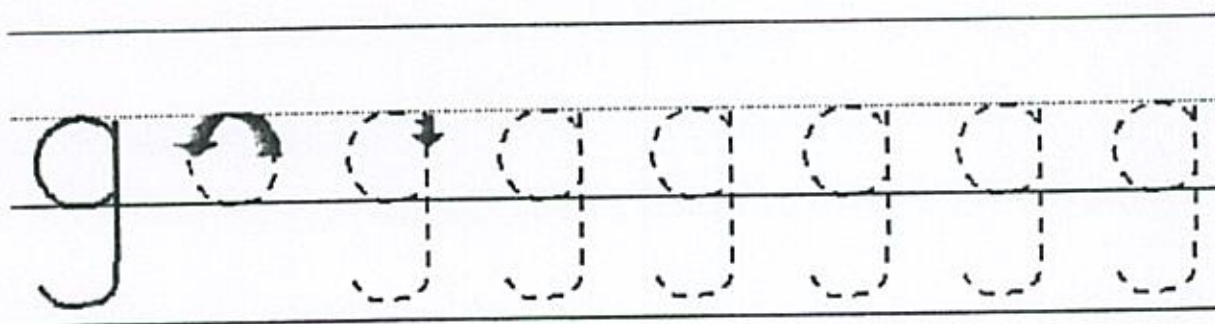
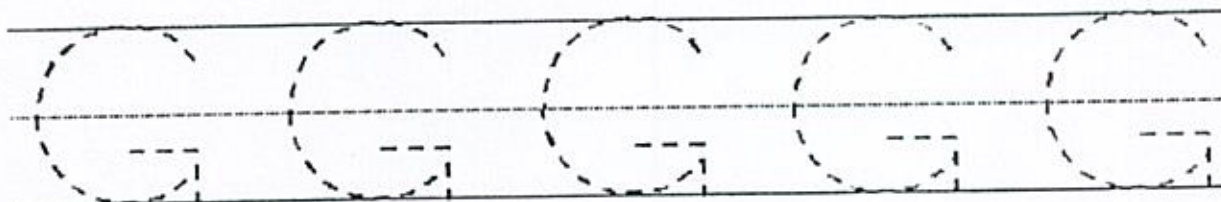
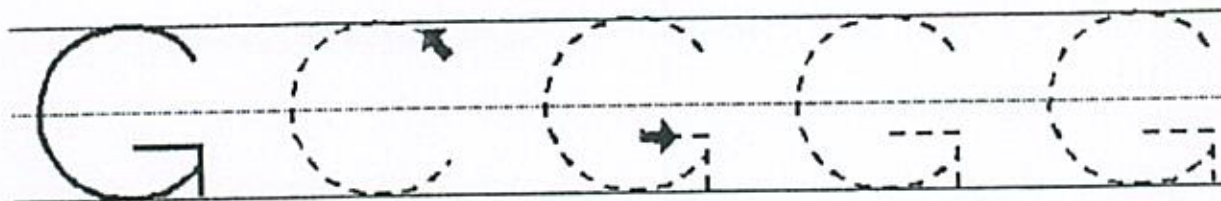

Wednesday

Color Sheet

Gg

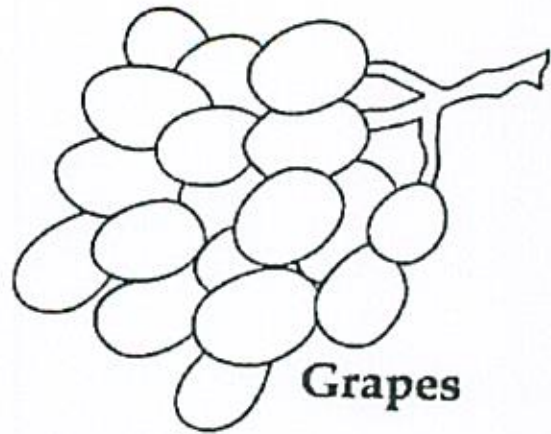

Grapes



Giraffe



Grasshopper



Gorilla

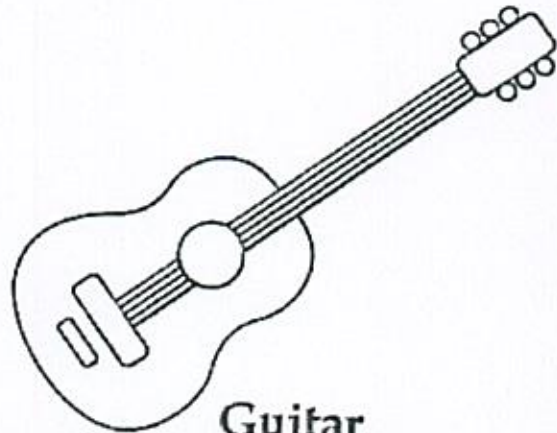

Guitar

Thursday

Art Activity

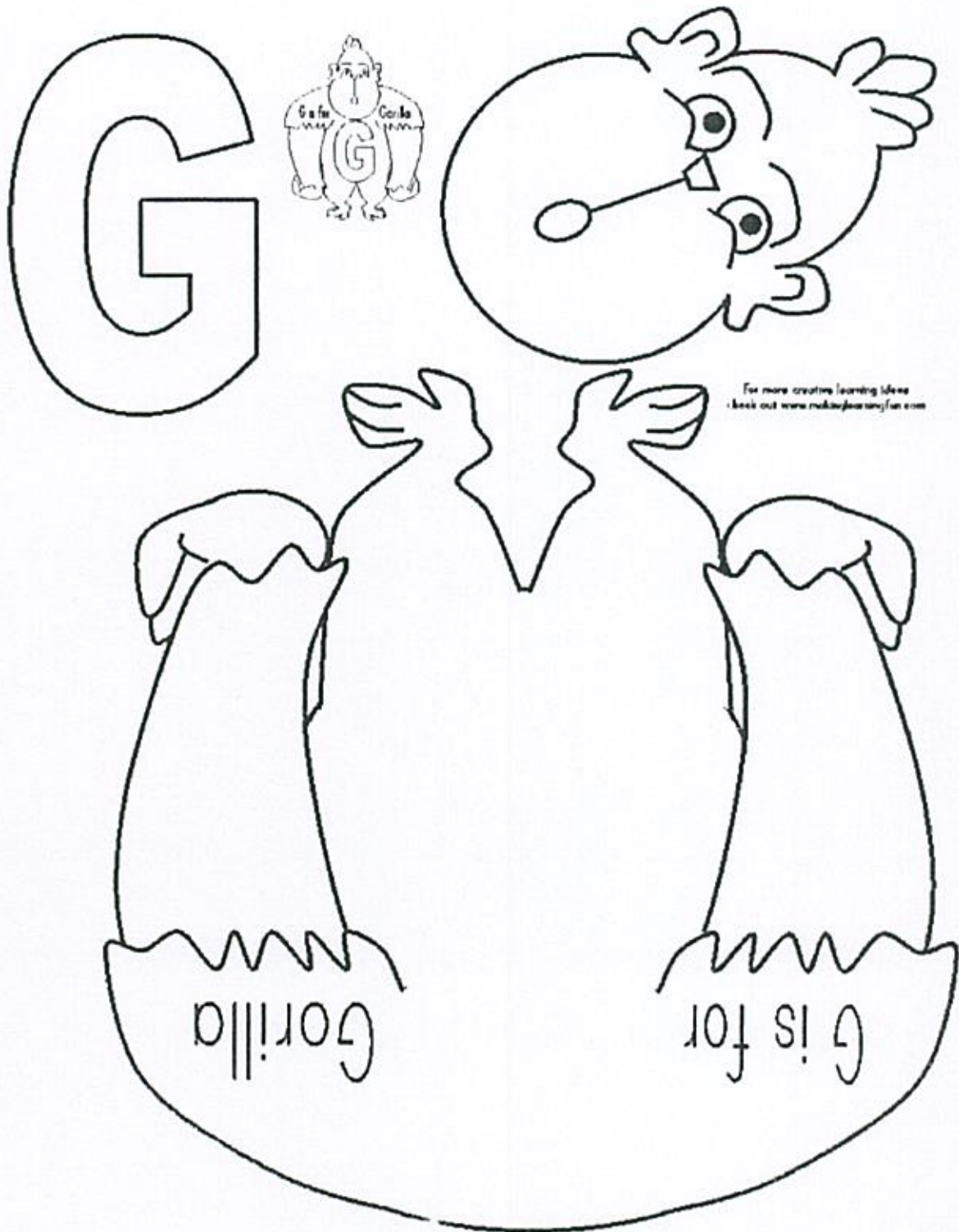

Friday

Name writing sheet

(Let the child write his/her name at the top and then on Saturday and Sunday let them write their name again)

**L.B.J. & C. Head Start
Children's Sign-in for Home**

Name:

Saturday:

Sunday:

Monday

Song for the letter of the week.

Tuesday

Letter activity sheet

H IS FOR HELICOPTER

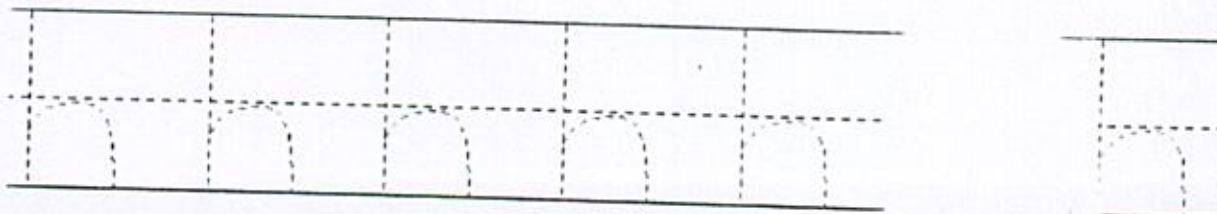
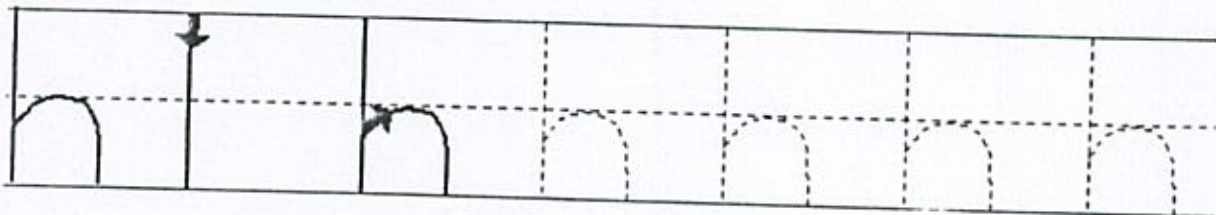
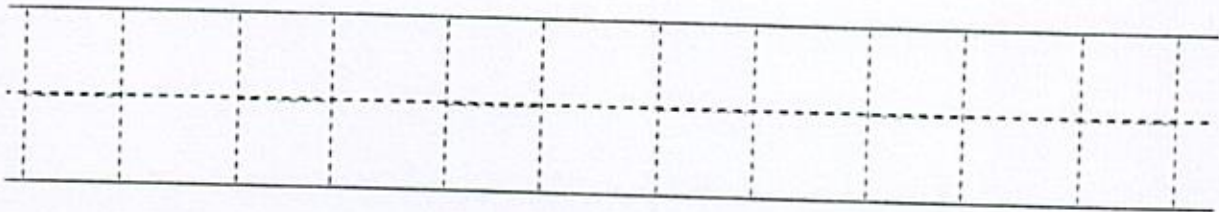
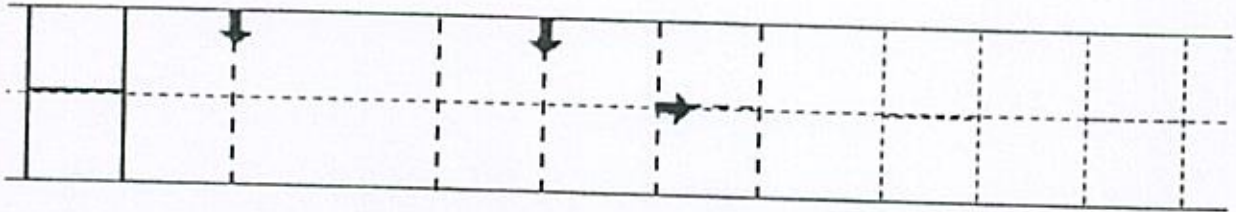

Wednesday

Color Sheet

Hh

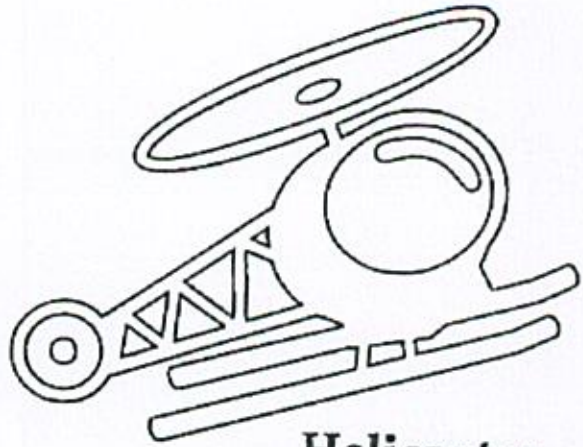

Helicopter



Hen



Hat

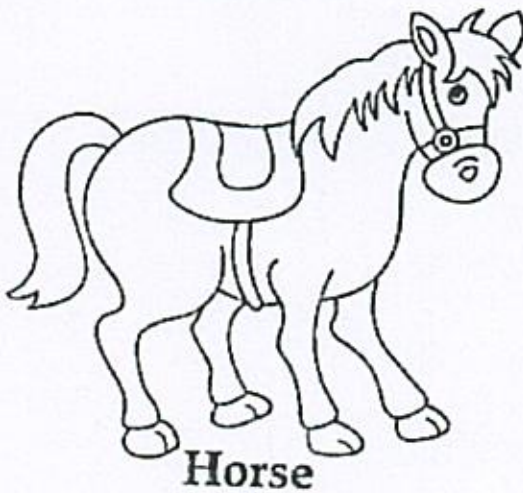

Horse

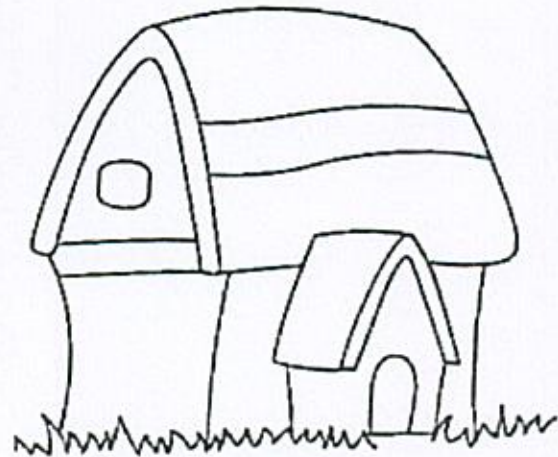

House

Thursday

Art Activity

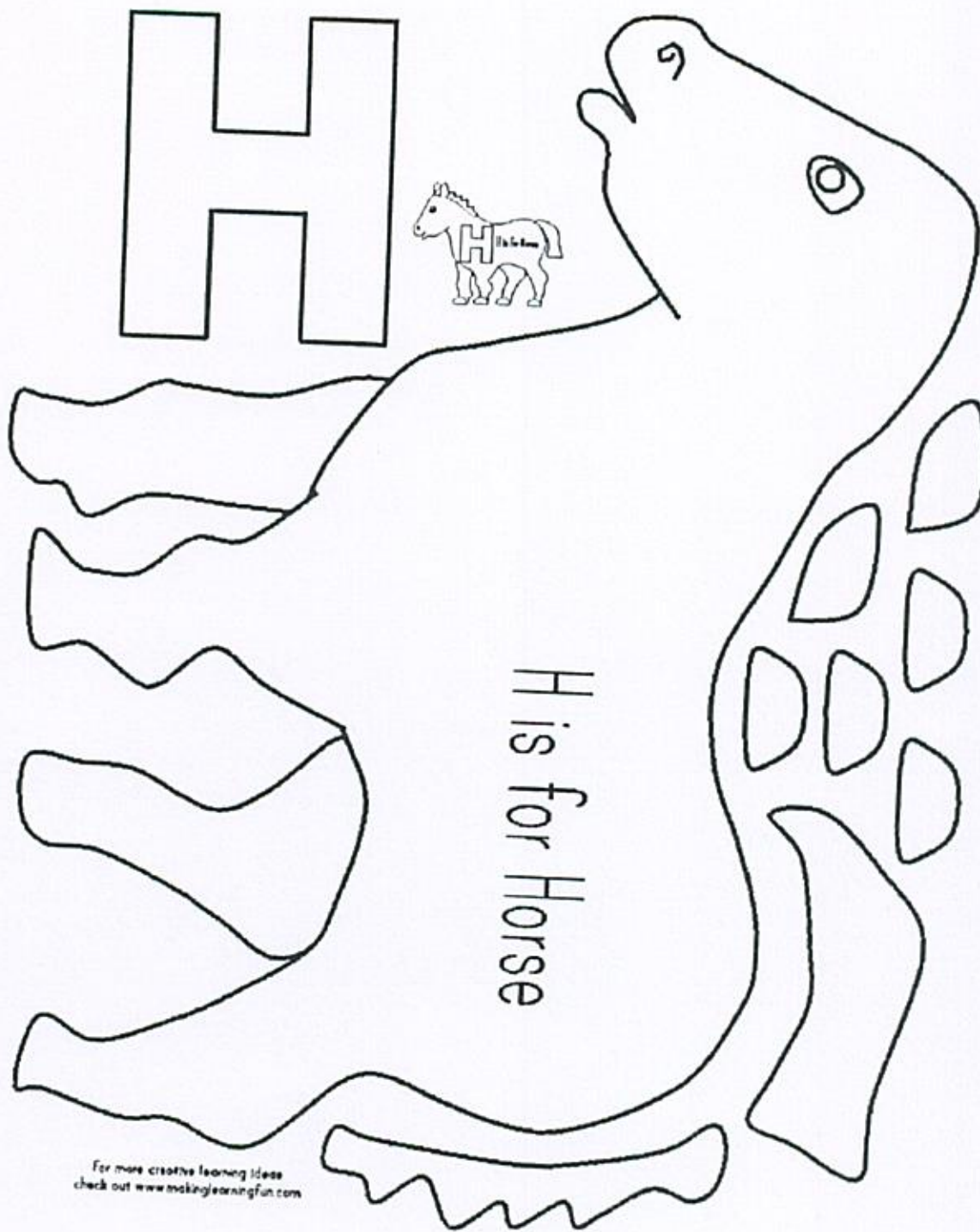

Friday

Name writing sheet

(Let the child write his/her name at the top and then on Saturday and Sunday let them write their name again)

**L.B.J. & C. Head Start
Children's Sign-in for Home**

Name:

Saturday:

Sunday:

Monday

Song for the letter of the week.

Isabella Inchworm

TUNE: I'M A LITTLE TEAPOT

**Isabella Inchworm, will you try
To name some things that begin with li?
"Into and Inside and In between,
Invisible means that you can't be seen!"
"Indians and igloos and insects too,
And interesting, intelligent, kids like you!"**

The End

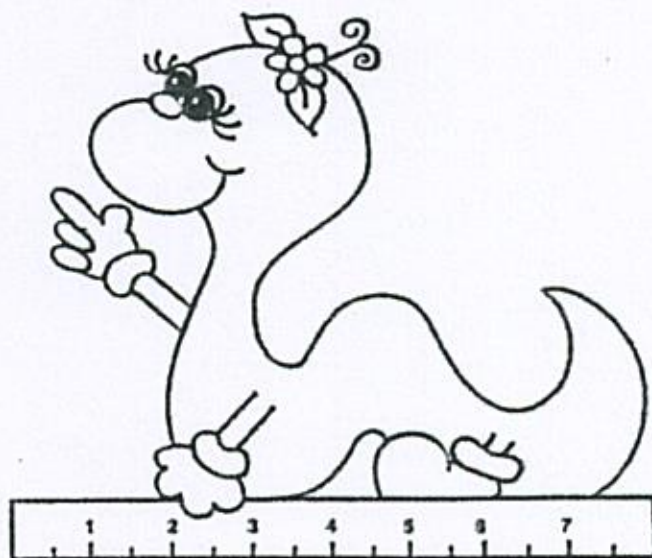

Tuesday

Letter activity sheet

I IS FOR ICE CREAM

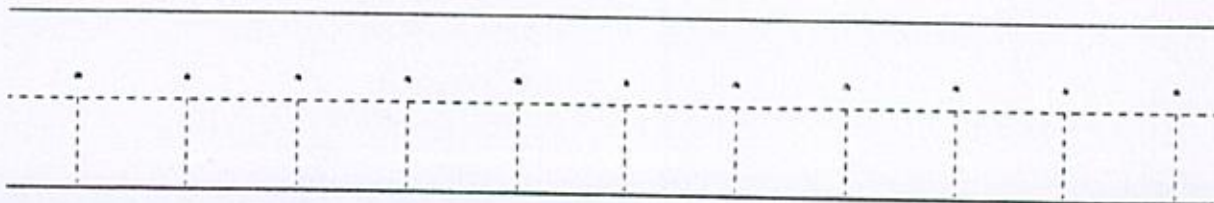
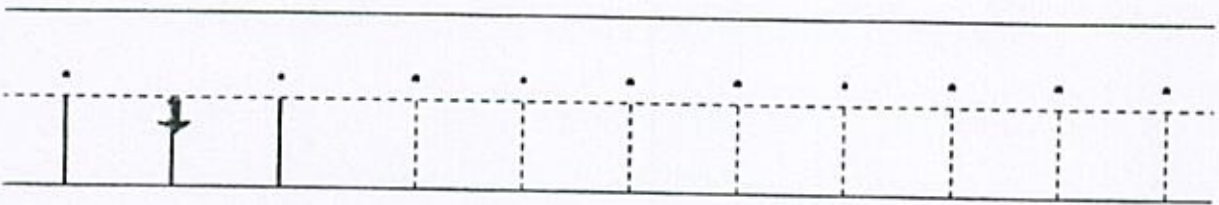
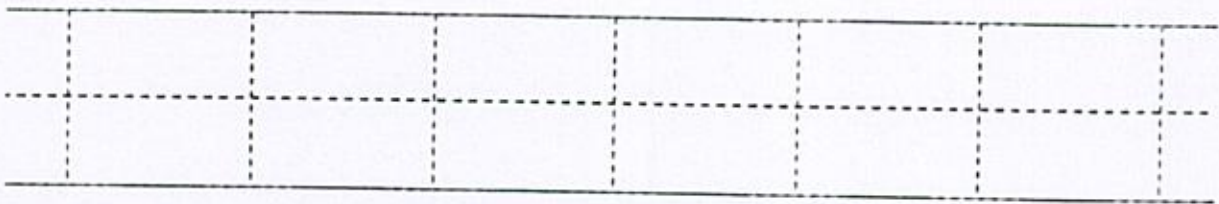
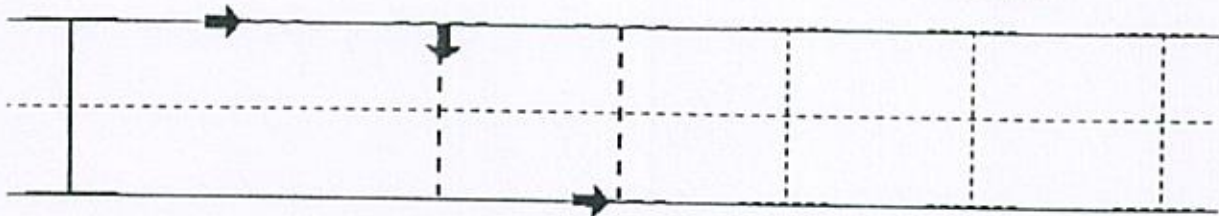

Wednesday

Color Sheet

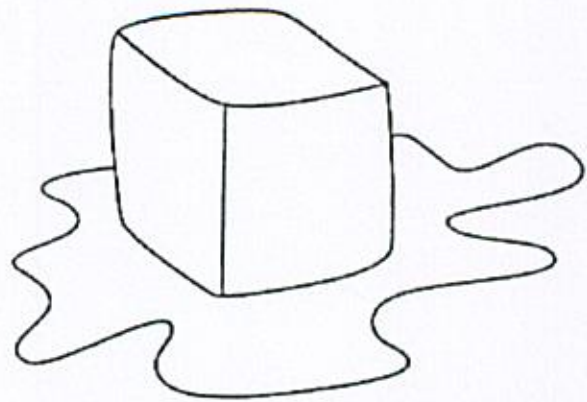

Ice



Ice cream



Infant

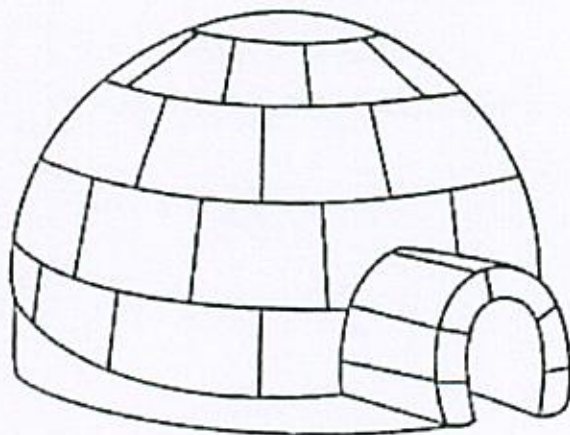

Igloo



Insect

Thursday

Art Activity

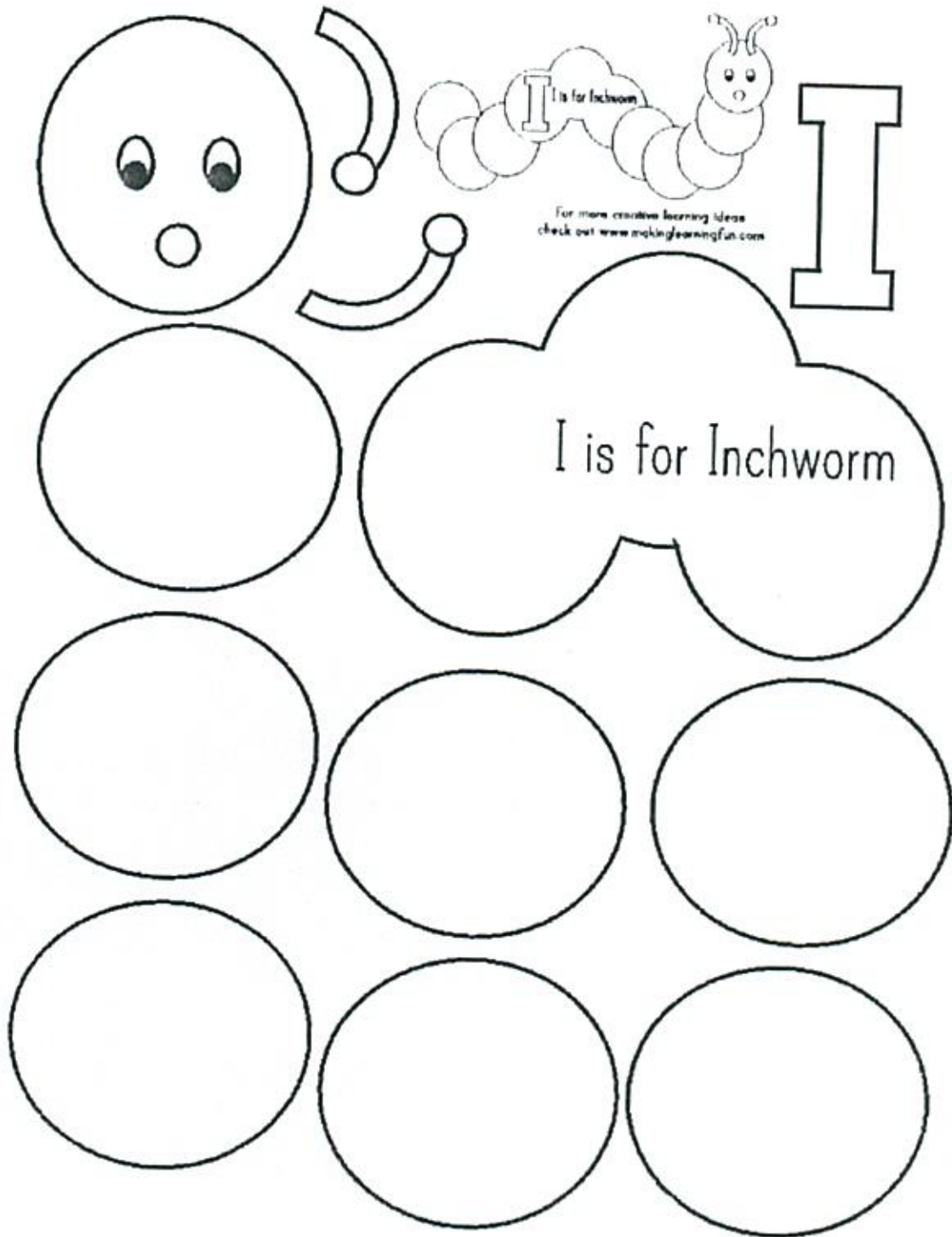

Friday

Name writing sheet

(Let the child write his/her name at the top and then on Saturday and Sunday let them write their name again)

**L.B.J. & C. Head Start
Children's Sign-in for Home**

Name:

Saturday:

Sunday:

Monday

Song for the letter of the week.

Tuesday

Letter activity sheet

J IS FOR JET

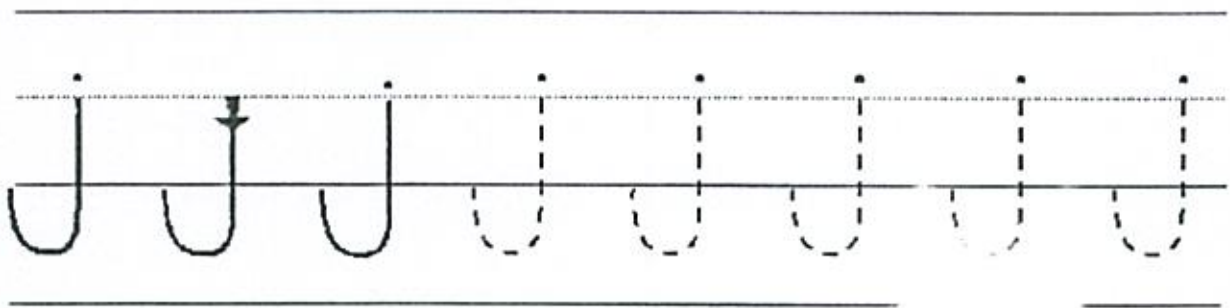
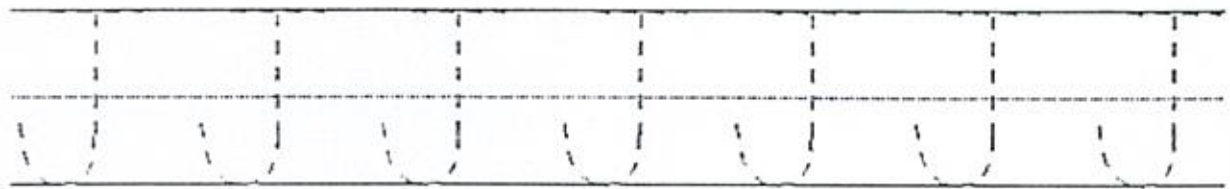
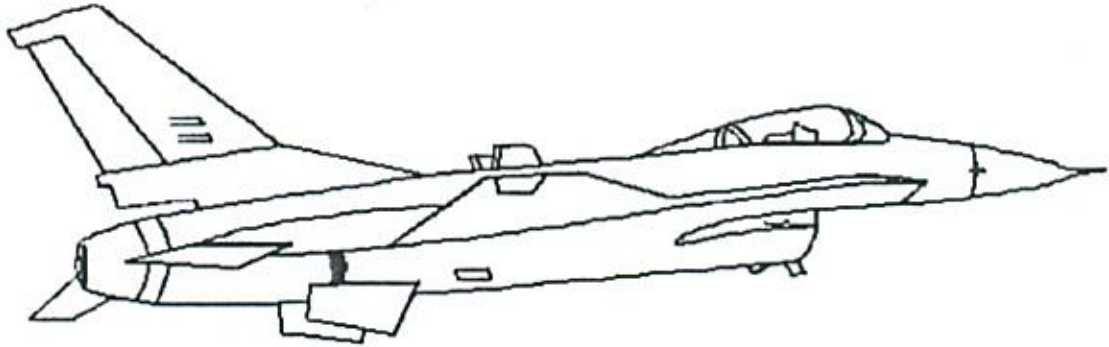

Wednesday

Color Sheet

J j

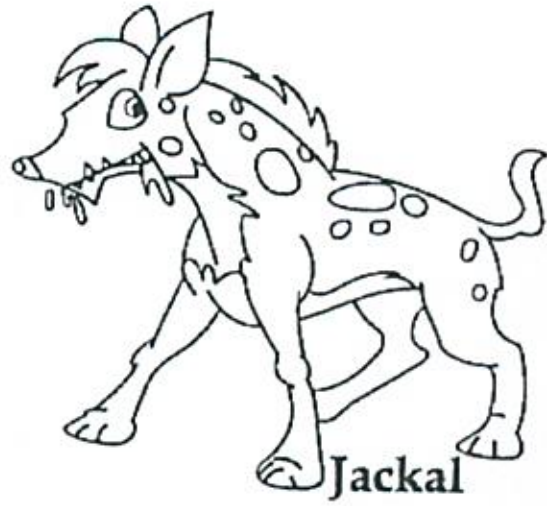

Thursday

Art Activity

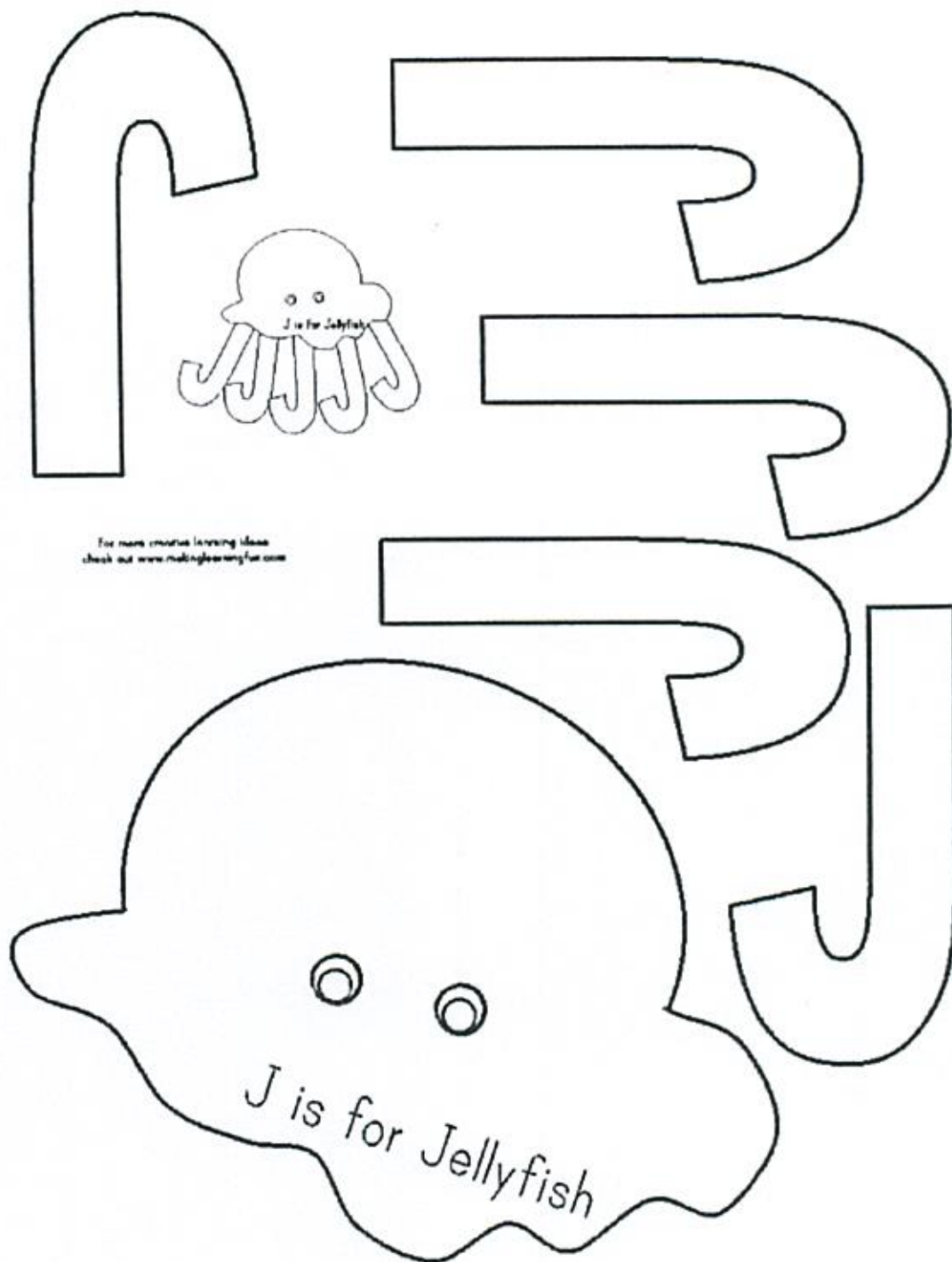

Friday

Name writing sheet

(Let the child write his/her name at the top and then on Saturday and Sunday let them write their name again)

L.B.J. & C. Head Start
Children's Sign-in for Home

Name:

Saturday:

Sunday:

Monday

Song for the letter of the week.

Tuesday

Letter activity sheet

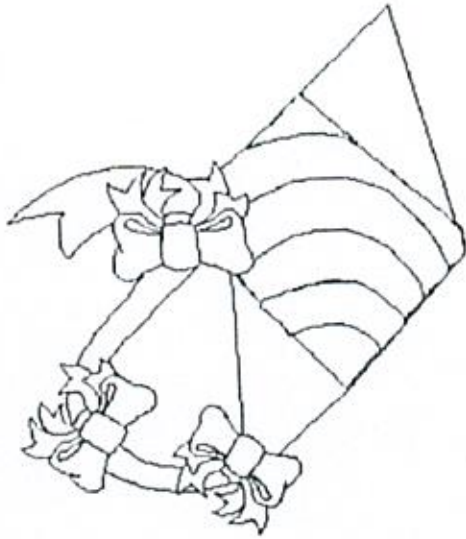

K IS FOR
KITE

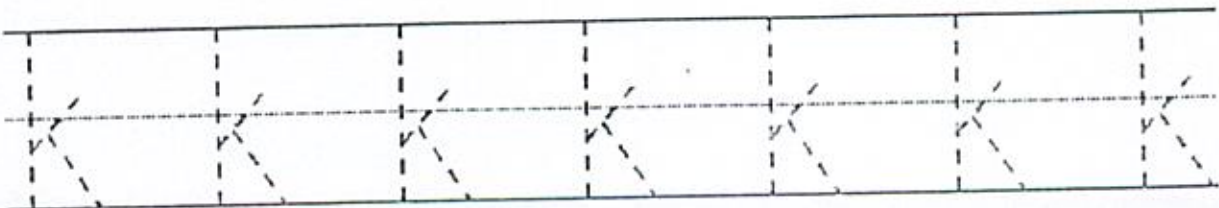
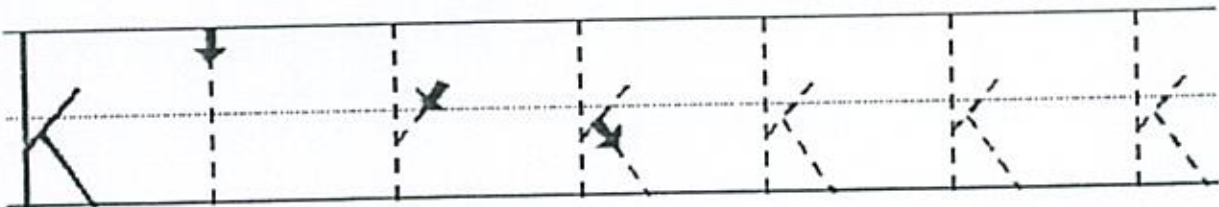
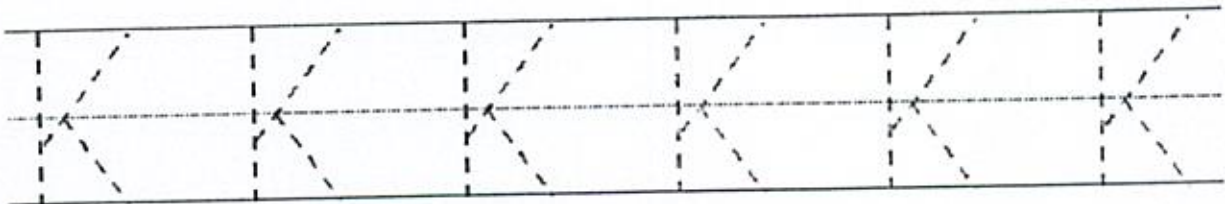
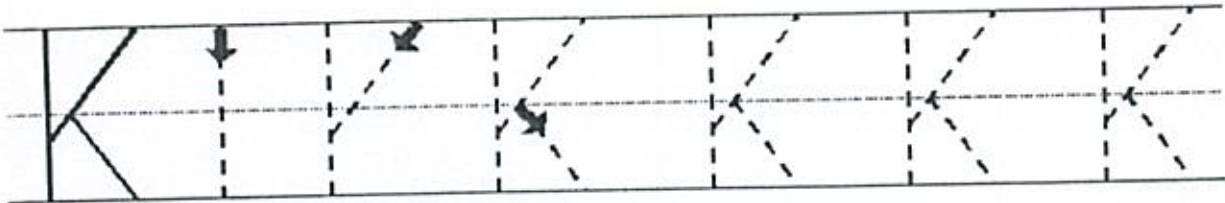

Wednesday

Color Sheet

Kk



Kangaroo



Kingfisher

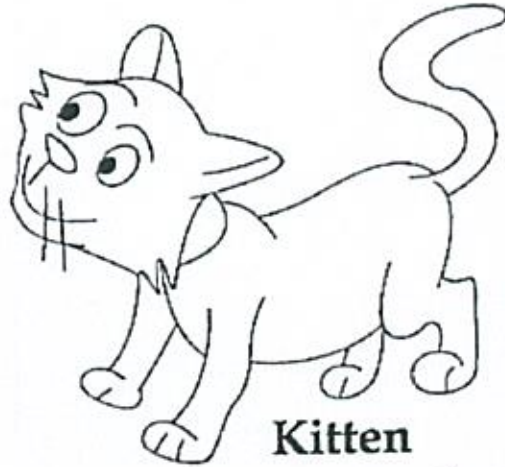

Kitten

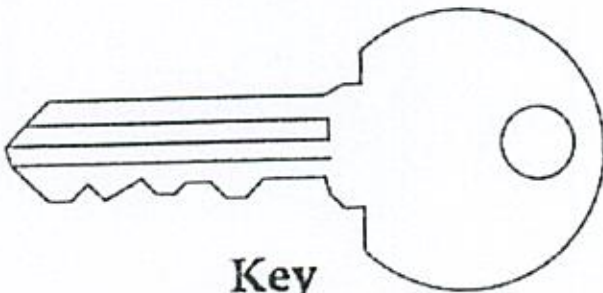

Key

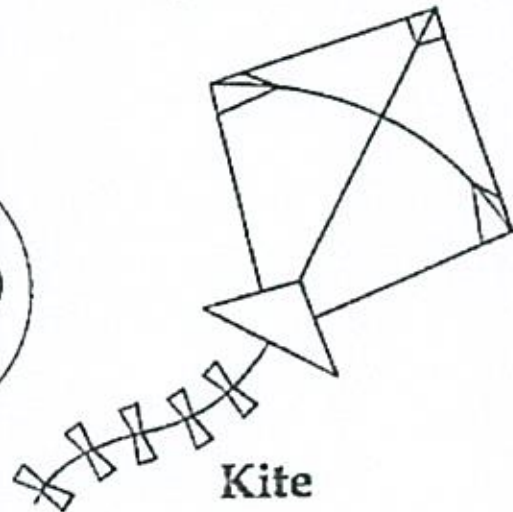

Kite

Thursday

Art Activity

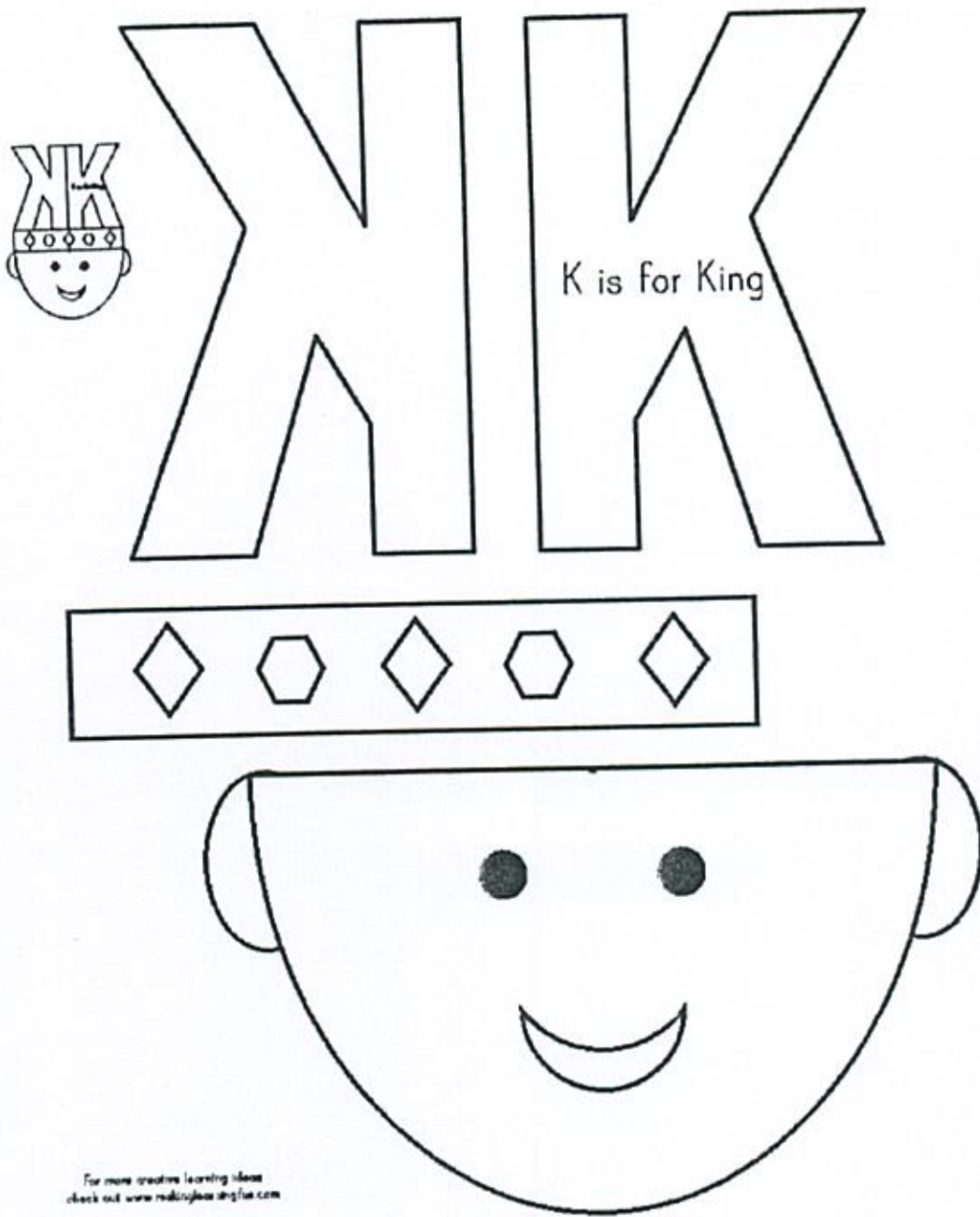

Friday

Name writing sheet

(Let the child write his/her name at the top and then on Saturday and Sunday let them write their name again)

**L.B.J. & C. Head Start
Children's Sign-in for Home**

Name:

Saturday:

Sunday:

Monday

Song for the letter of the week.



Larry Lion

TUNE: JINGLE BELLS

**Larry Lion, Larry Lion,
Look down in your well.**

**Wish for all your favorite things
That start with letter L.**

**Lemon drops,
Lollipops,
Lemonade for sale,
These are all my favorite things
That start with letter L.**

The End



Tuesday

Letter activity sheet



L IS FOR
LADYBUG

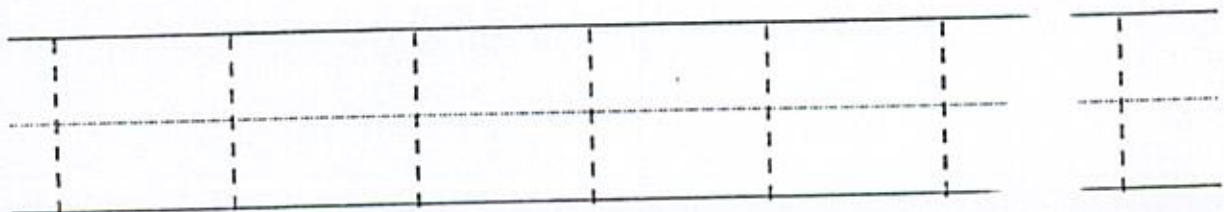
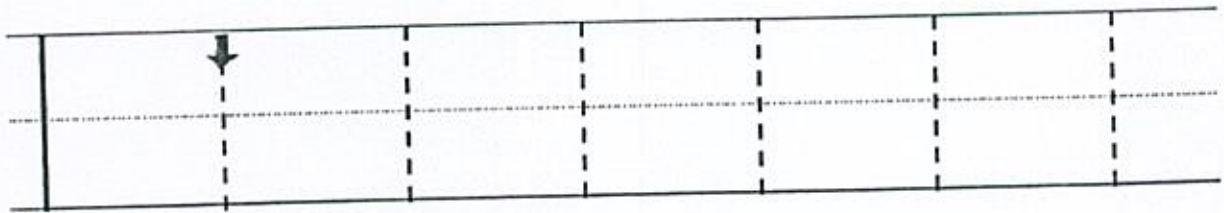
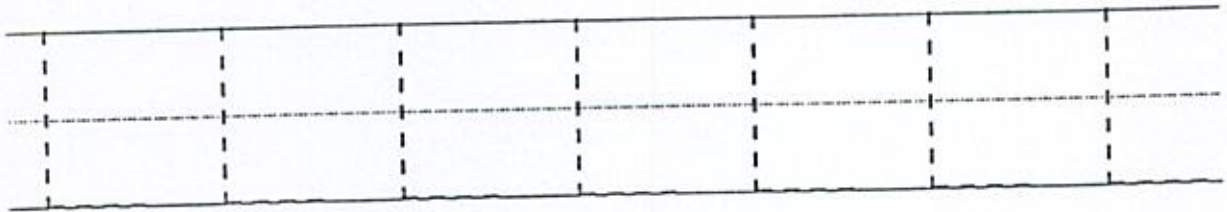

Wednesday

Color Sheet

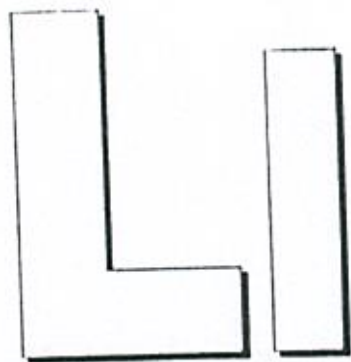

Lion



Leaf

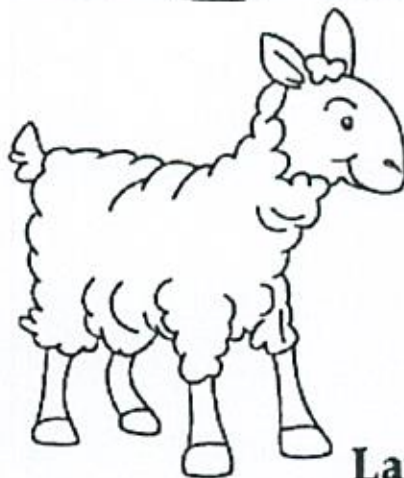

Lamb



Lobster

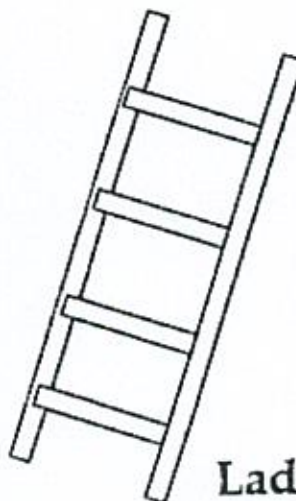

Ladder

Thursday

Art Activity

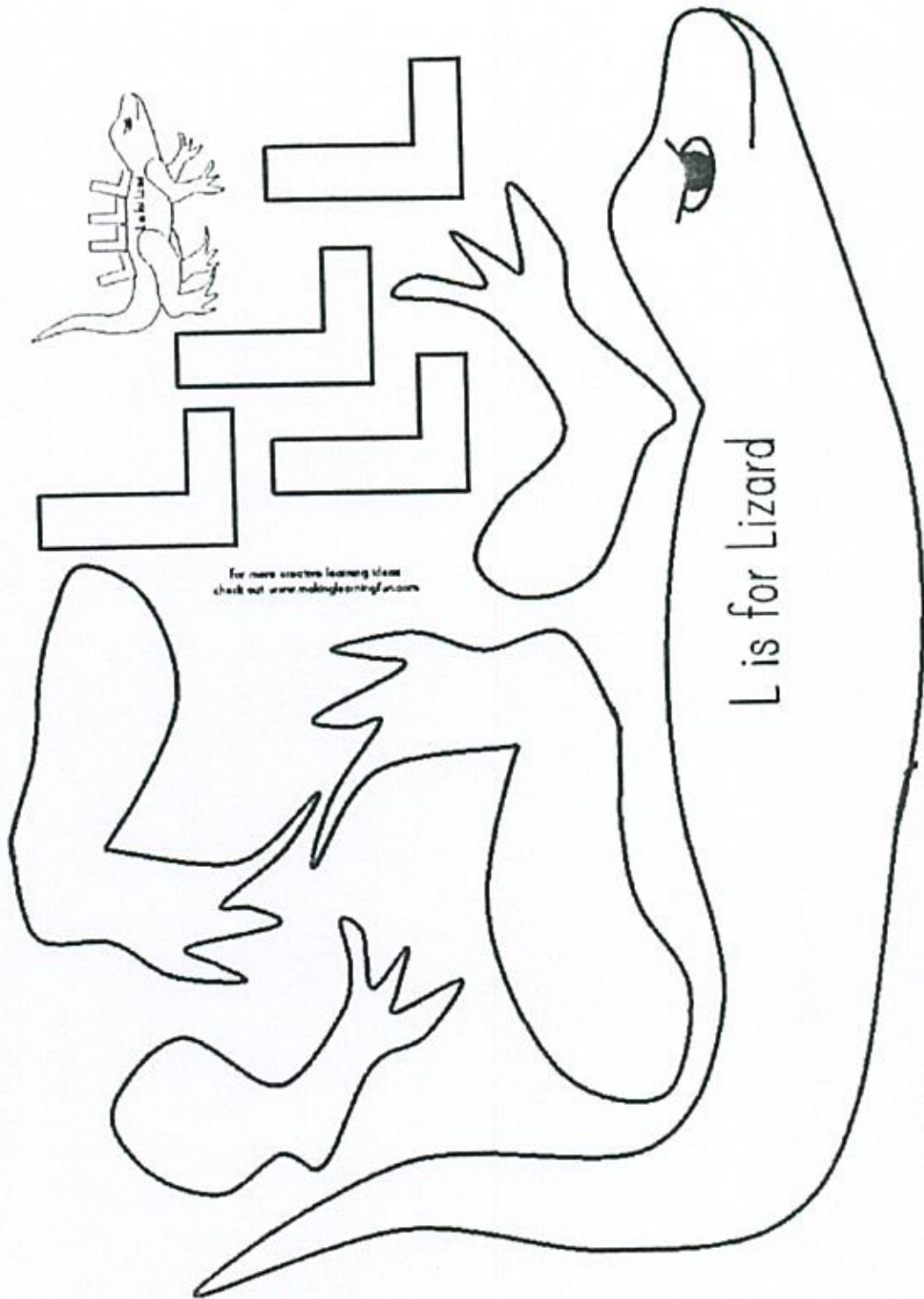

Friday

Name writing sheet

(Let the child write his/her name at the top and then on Saturday and Sunday let them write their name again)

**L.B.J. & C. Head Start
Children's Sign-in for Home**

Name:

Saturday:

Sunday:

Monday

Song for the letter of the week.

Tuesday

Letter activity sheet

M IS FOR MOTORCYCLE

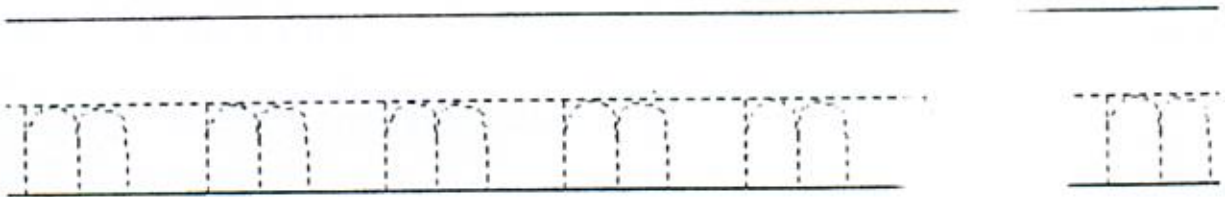
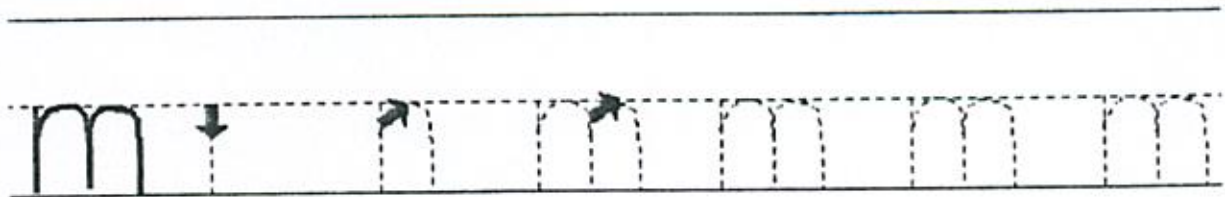
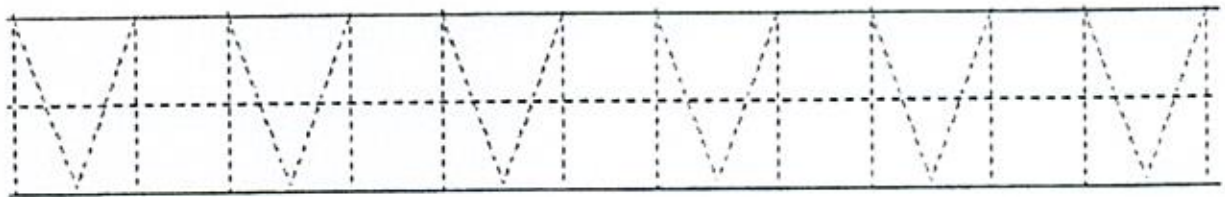
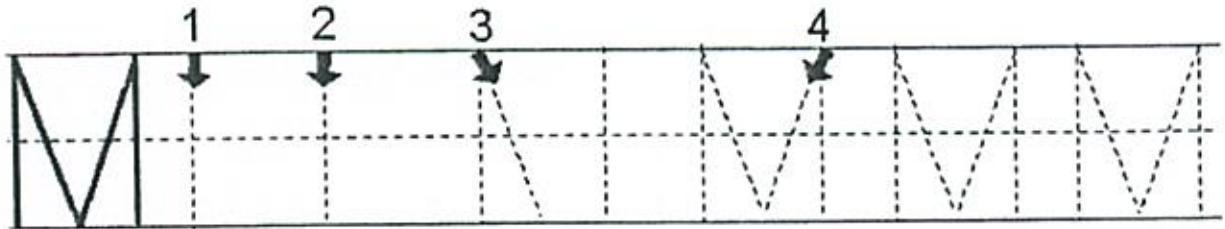
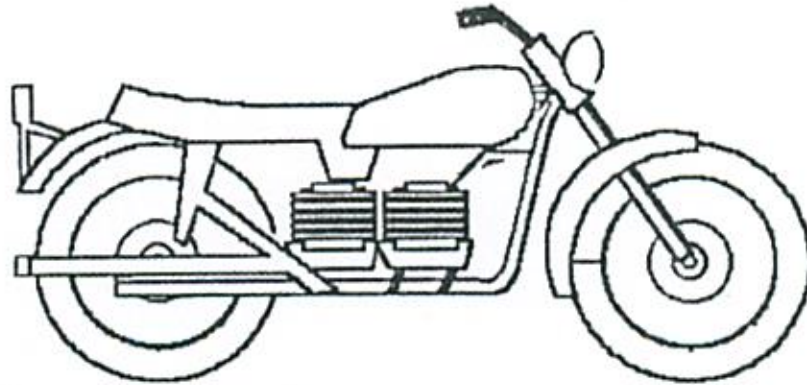

Wednesday

Color Sheet

Mm

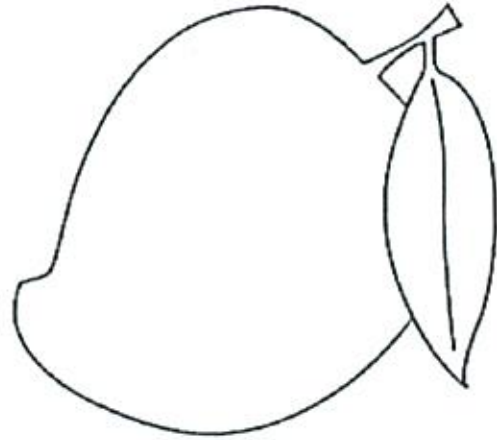

Mango



Monkey

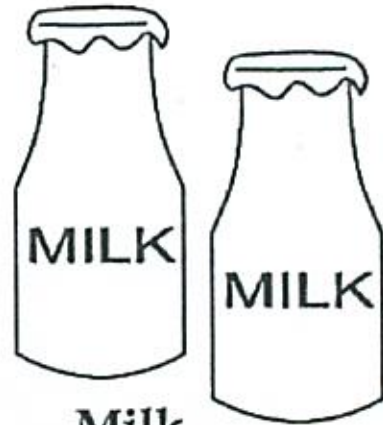

Milk



Moon

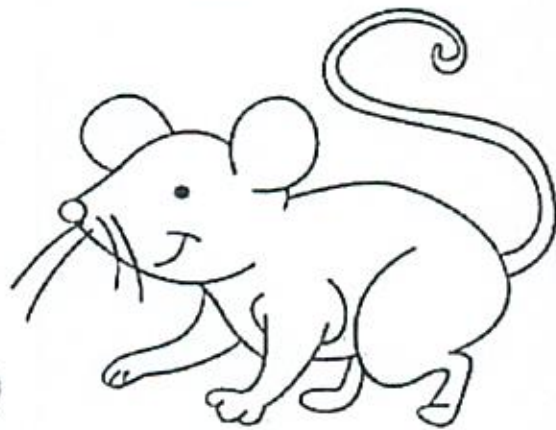

Mouse

Thursday

Art Activity

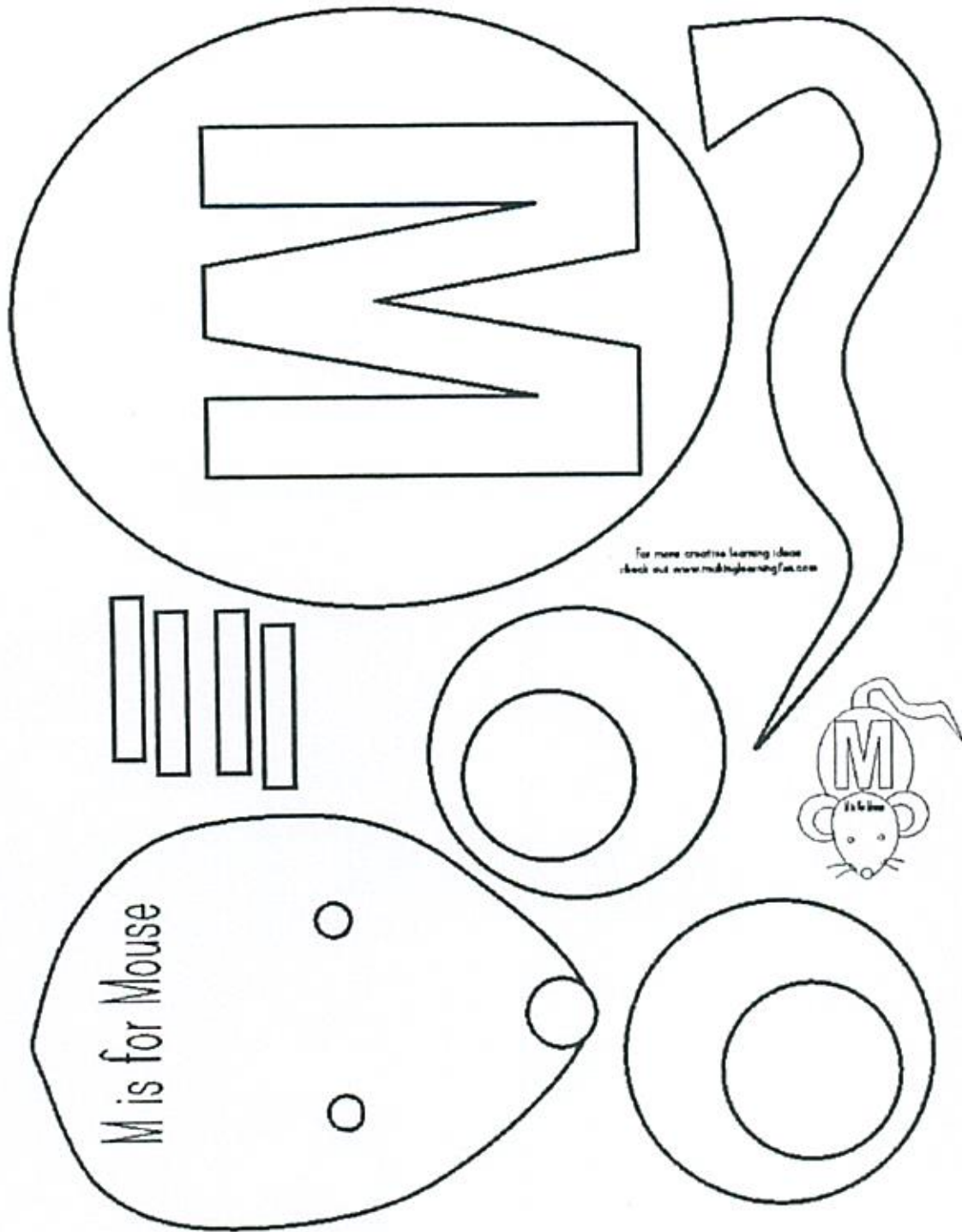

For more creative learning ideas
check out www.makinglearningfun.com

Friday

Name writing sheet

(Let the child write his/her name at the top and then on Saturday and Sunday let them write their name again)

L.B.J. & C. Head Start
Children's Sign-in for Home

Name:

Saturday:

Sunday:

Monday

Song for the letter of the week.

Tuesday

Letter activity sheet

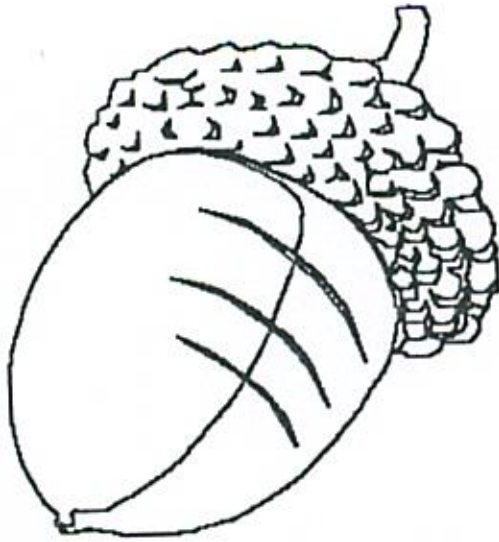

N IS FOR
NUT

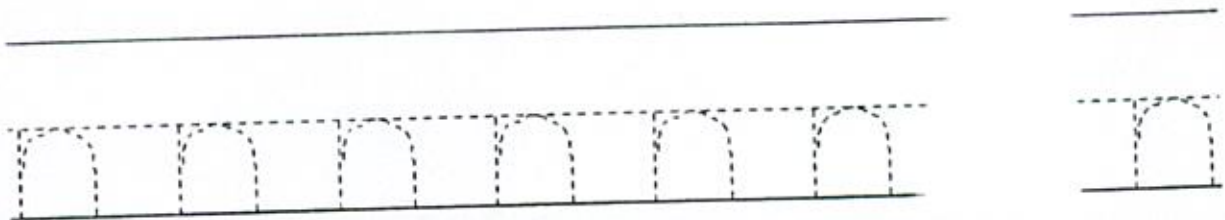
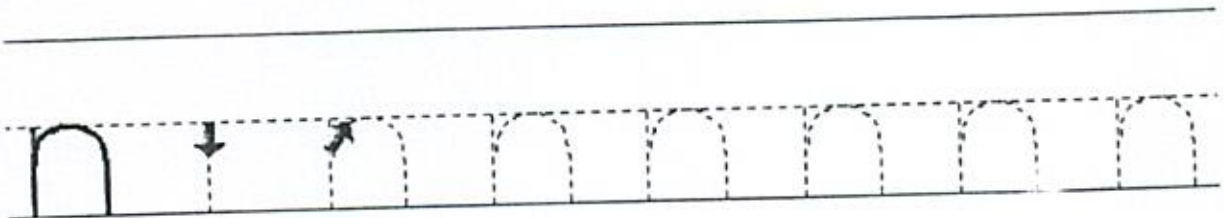
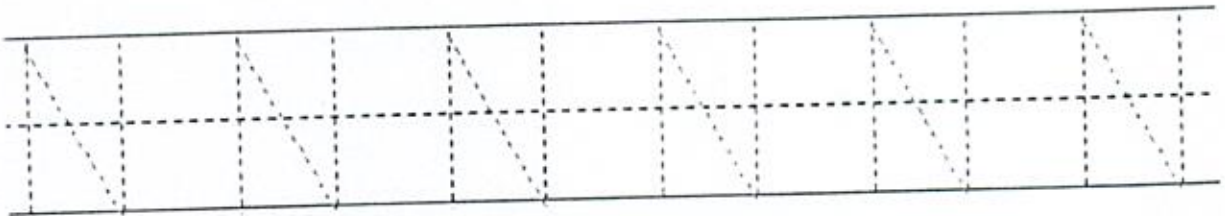
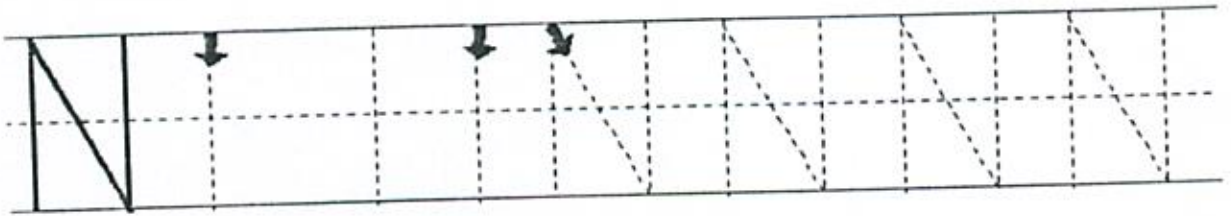

Wednesday

Color Sheet

Nn

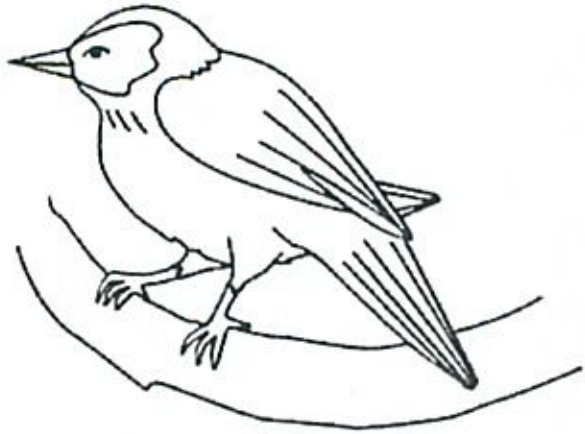

Nightingale



Nose



Nest

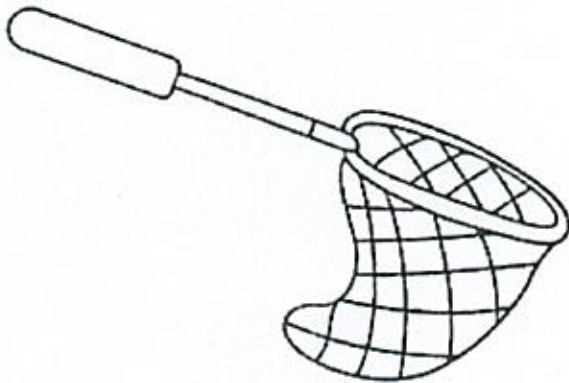

Net

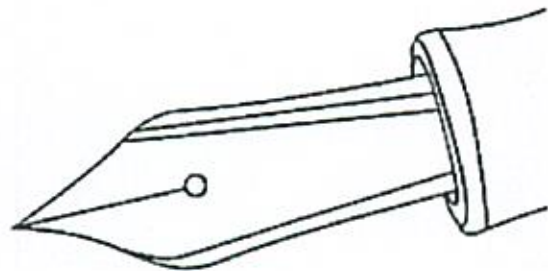

Nib

Thursday

Art Activity

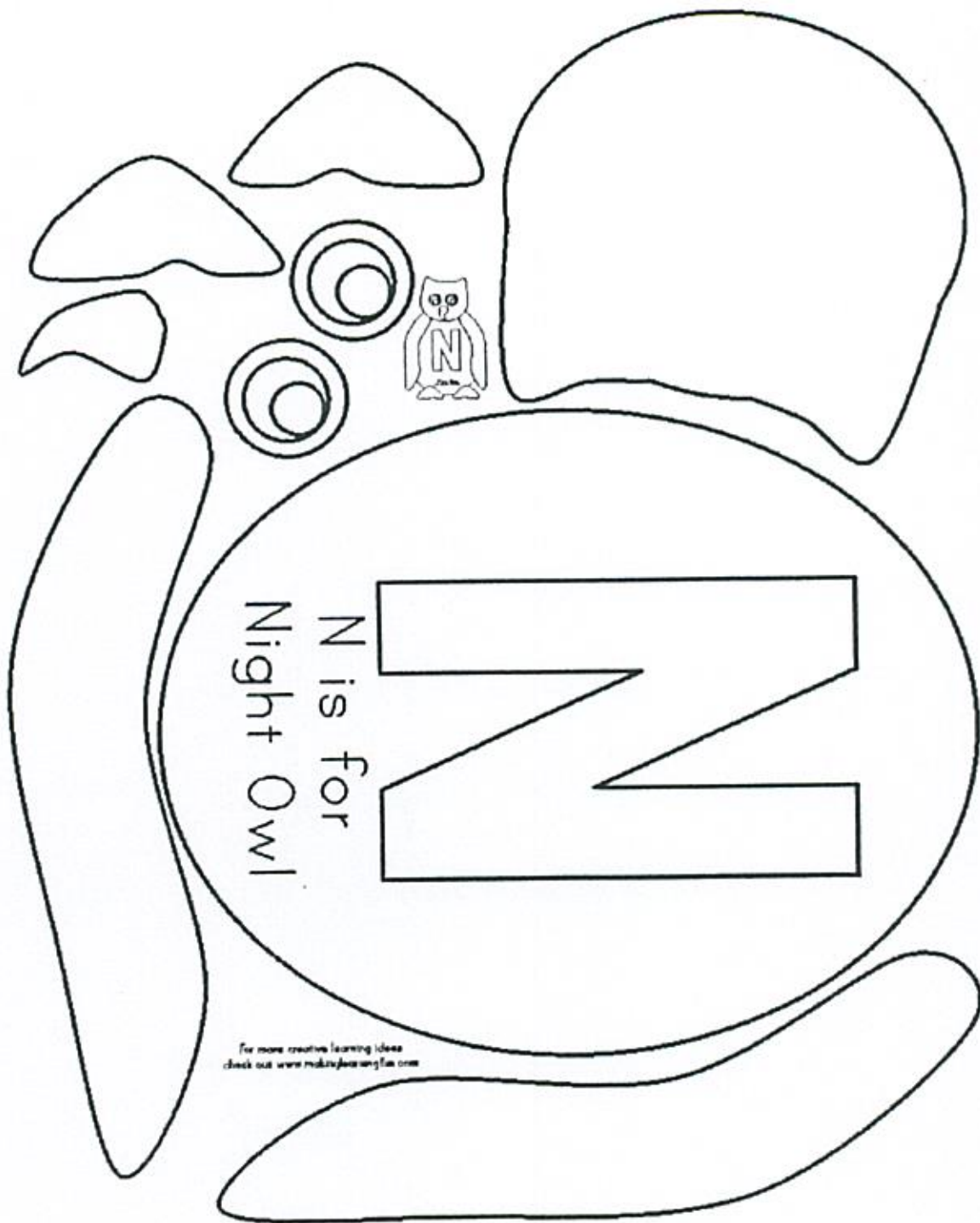

Friday

Name writing sheet

(Let the child write his/her name at the top and then on Saturday and Sunday let them write their name again)

**L.B.J. & C. Head Start
Children's Sign-in for Home**

Name:

Saturday:

Sunday:

Monday

Song for the letter of the week.

oooooooooooooooooooooooooooooooooooooooooooooooooooo

Octopus Stew
TUNE: BEAUTIFUL DREAMER
Here is a question,
I'd like to know.
What can you name
That begins with an O?
Oxen and otters,
Ostriches too,
Oranges and olives,
And octopus stew.
The End



oooooooooooooooooooooooooooooooooooooooooooooooooooo

Tuesday

Letter activity sheet

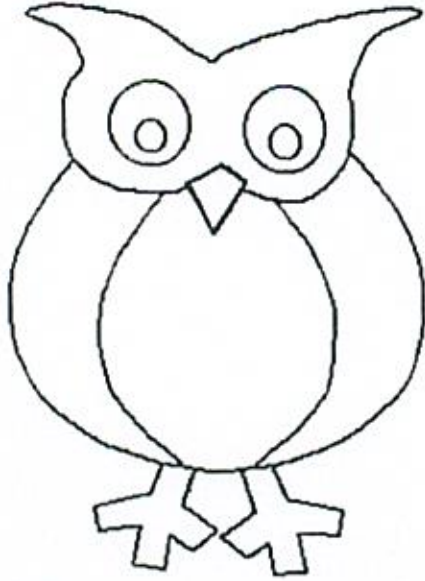

O IS FOR
OWL

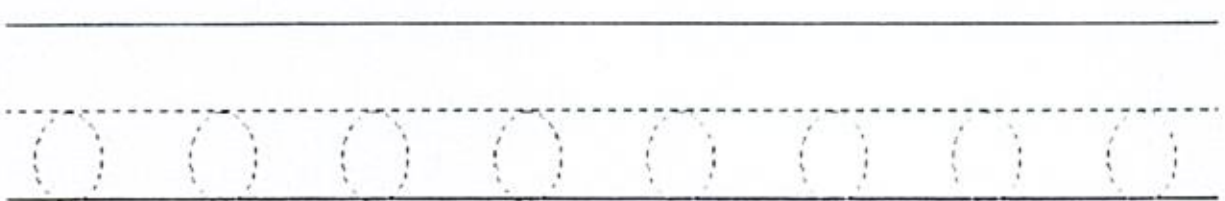
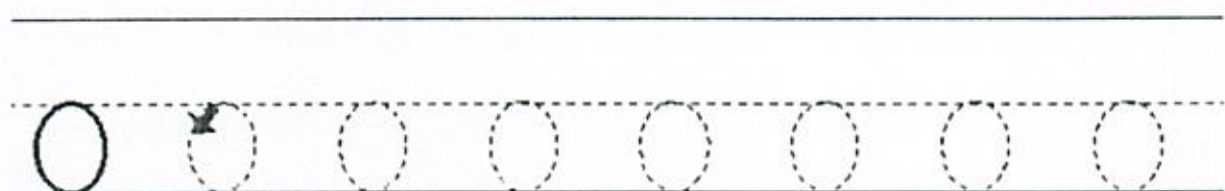
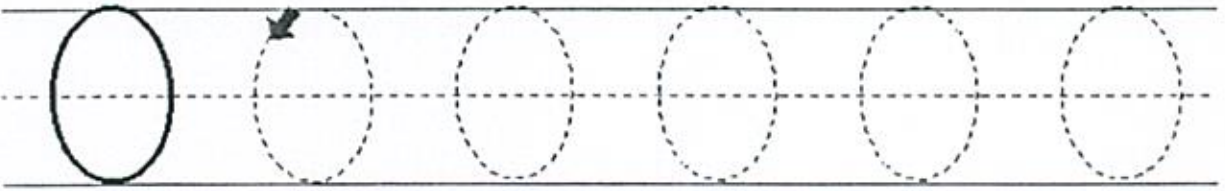

Wednesday

Color Sheet

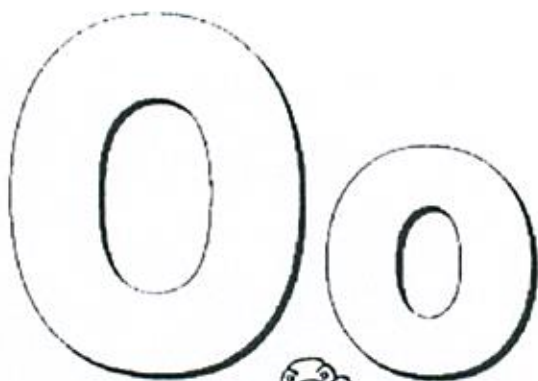

Octopus

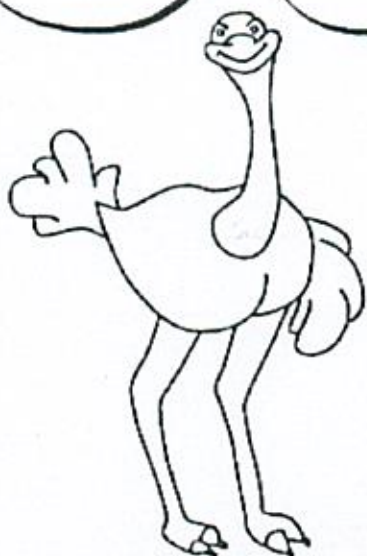

Ostrich

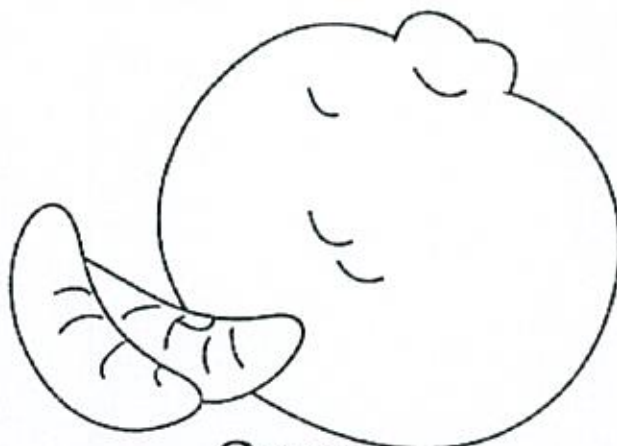

Orange



Owl

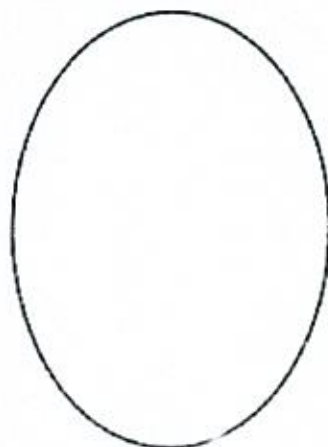

Ova

Thursday

Art Activity

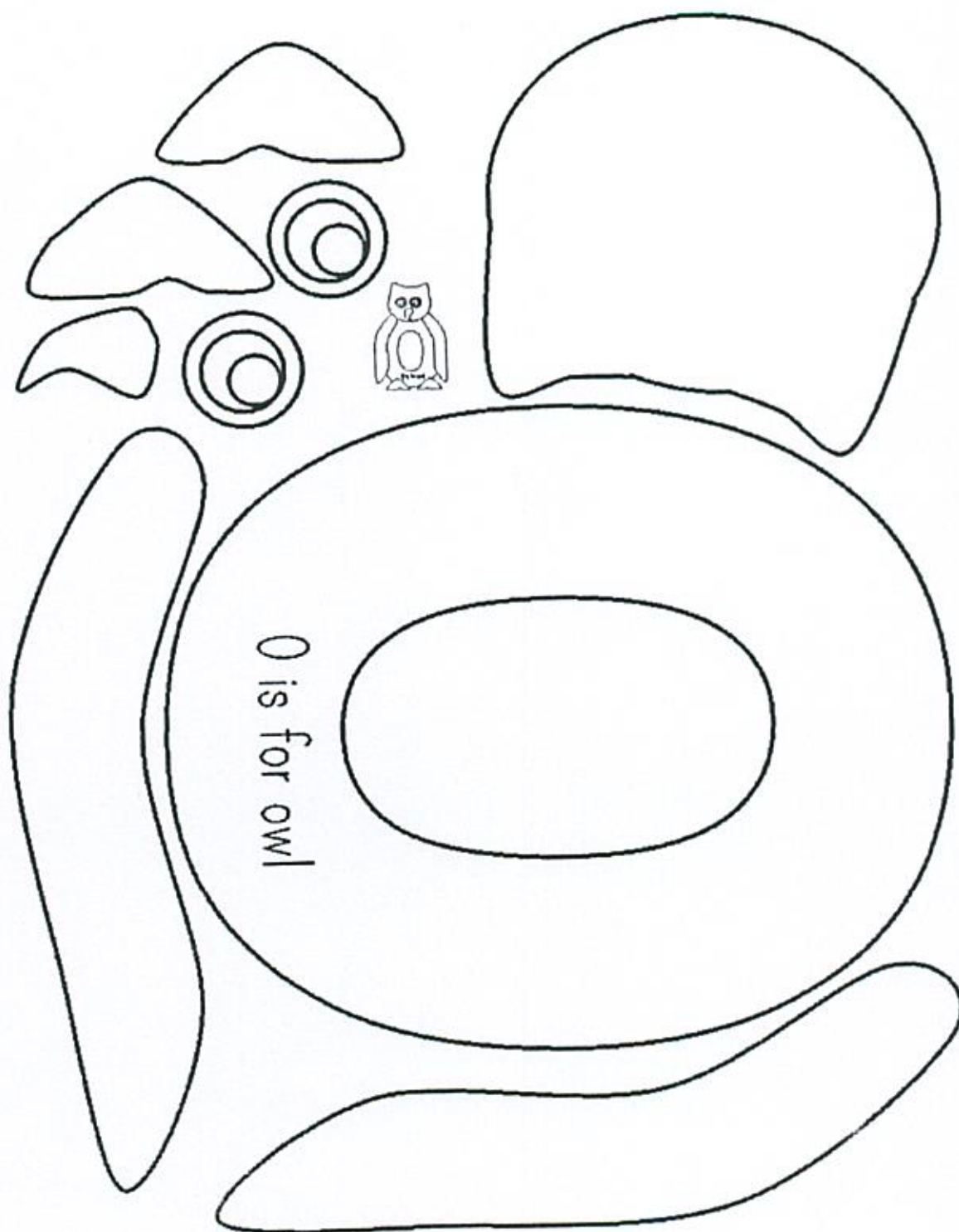

Friday

Name writing sheet

(Let the child write his/her name at the top and then on Saturday and Sunday let them write their name again)

**L.B.J. & C. Head Start
Children's Sign-in for Home**

Name:

Saturday:

Sunday:

Monday

Song for the letter of the week.



PPPPPPPPPPPPPPPPPPPPPPPPPPPPPPPP

Penelope Pig

TUNE: REUBEN, REUBEN

**Penelope Pig and her pal Polly,
Packed a perfect little lunch.
Went down to the penguin's picnic,
Drank up all the purple punch.
While the penguins played some ping-pong,
They were left there all alone.
They ate every lunch they came to,
Until all the food was gone.
50 pounds of roasted peanuts,
Popcorn pilled up to the sky,
13 jars of peanut butter,
15 plates of pizza pie,
Pickles, pears, and pink popsicles,
They just couldn't bear to stop.
When the penguins came to eat lunch.
They were just about to pop!
The End**

PPPPPPPPPPPPPPPPPPPPPPPPPPPPPPPP P P P P P

Tuesday

Letter activity sheet



Wednesday
P IS FOR

Color Sheet

PARROT

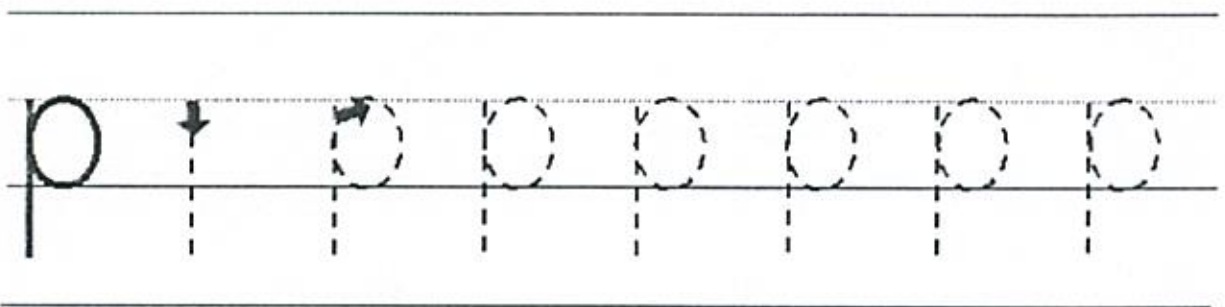
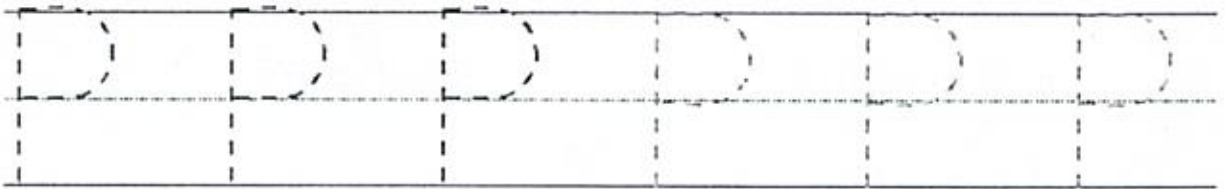
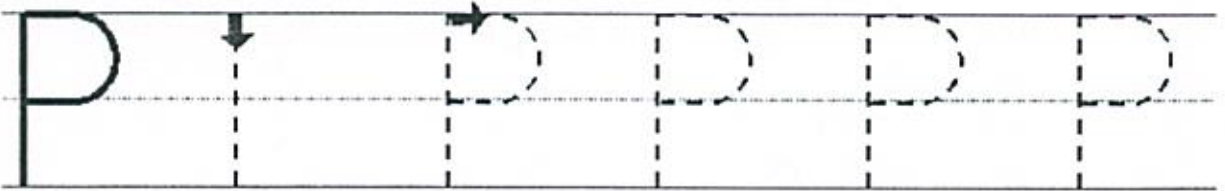

Thursday

Art Activity

P is for Pig

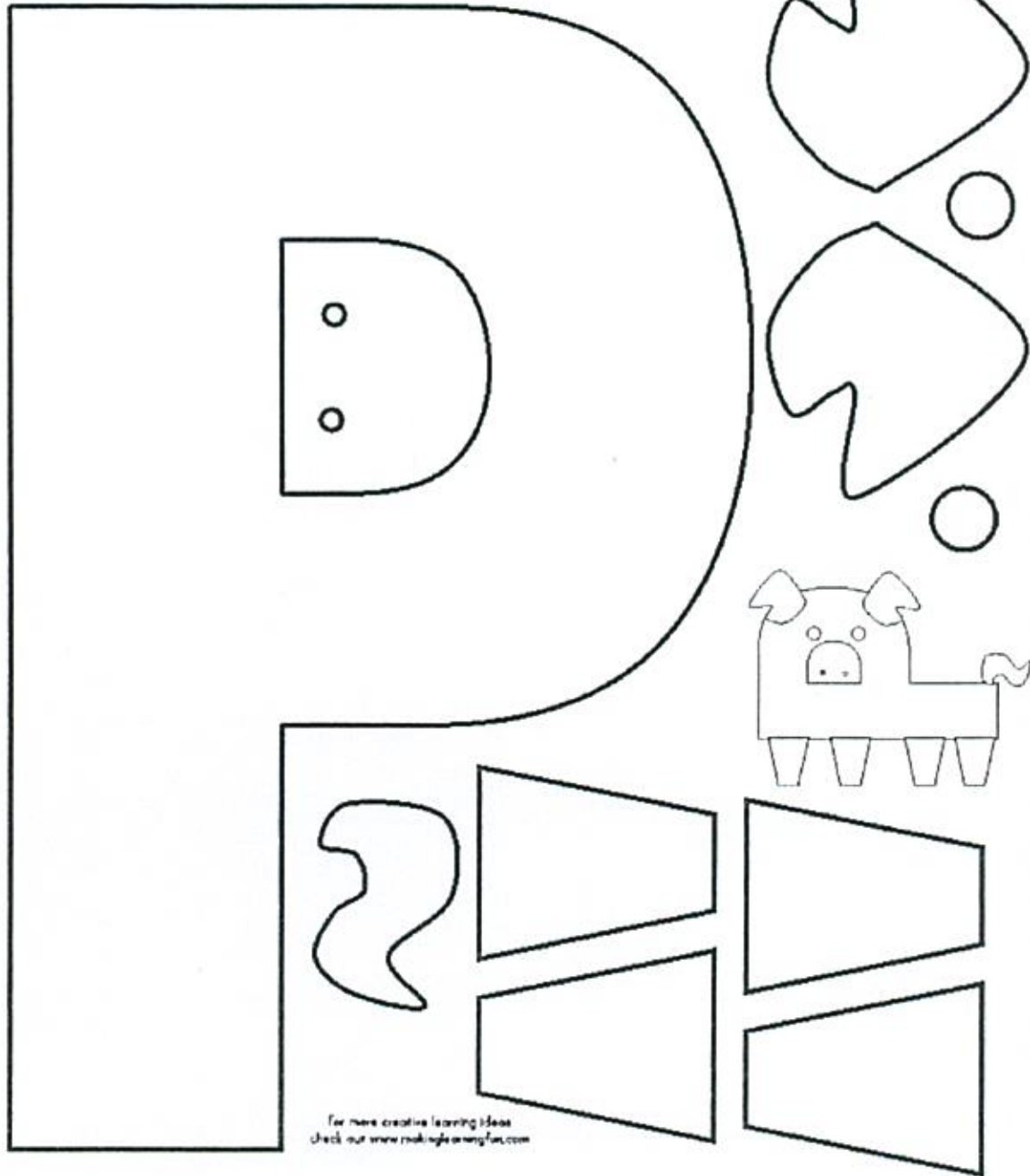

For more creative learning ideas
check out www.makinglearningfun.com

Friday

Name writing sheet

(Let the child write his/her name at the top and then on Saturday and Sunday let them write their name again)

**L.B.J. & C. Head Start
Children's Sign-in for Home**

Name:

Saturday:

Sunday:

Monday

Song for the letter of the week.

QQQQQQQQQQQQQQQQQQQQQQQQQQQQQQQQQQ

Quilla the Queen

TUNE: BEAUTIFUL DREAMER

Quilla the Queen, oh how do you do?
What can you do that begins with a Qq?
"I am the queen of a kingdom that's quiet.
I'm quick at quilting I do it all night."
"I have a quirk that people don't like.
I like to quarrel and get in a fight.
I met a wizard all dressed in black.
He changed me quite quickly
And now I just quack."

The End



QQQQQQQQQQQQQQQQQQQQQQQQQQQQQQQQ

QQQQQ

Tuesday

Letter activity sheet



Q IS FOR
QUEEN

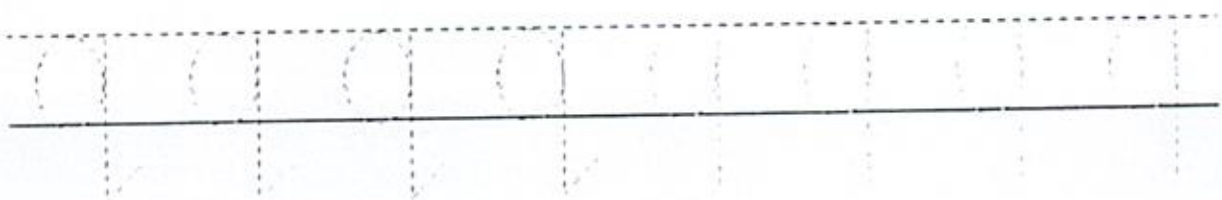
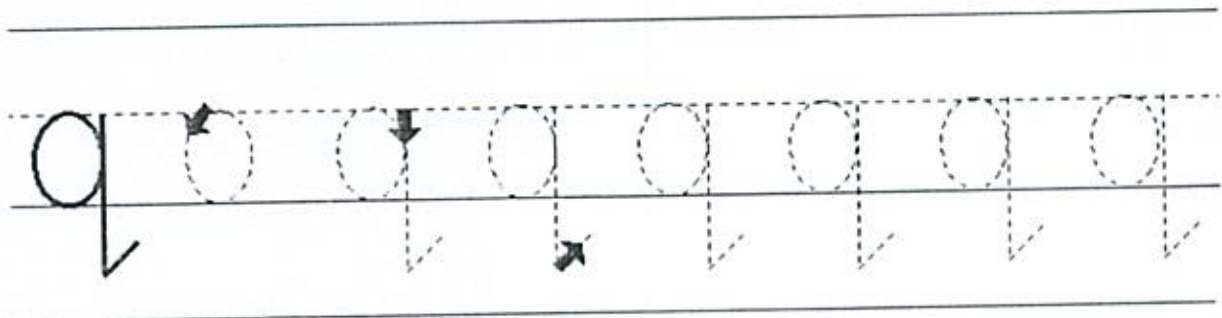
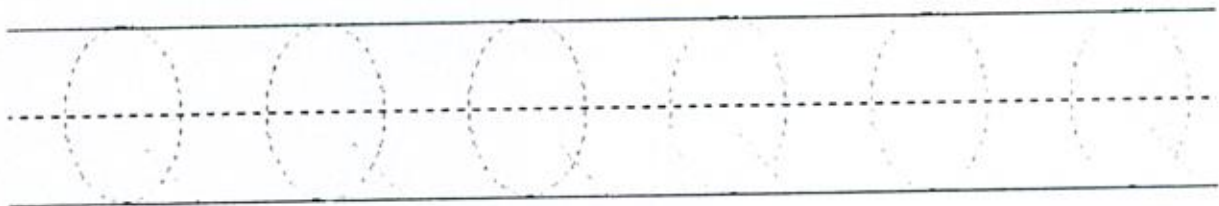
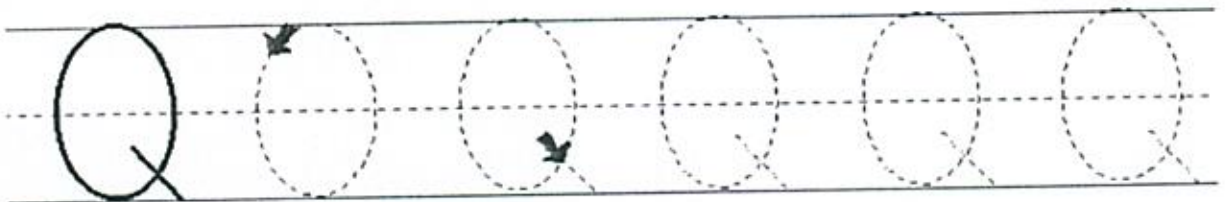

Wednesday

Color Sheet

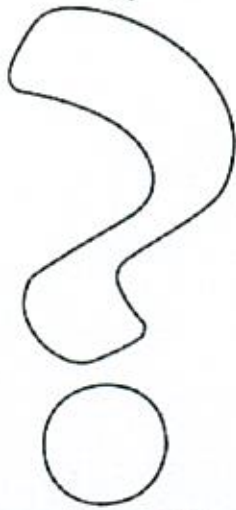

Question Mark



Queen

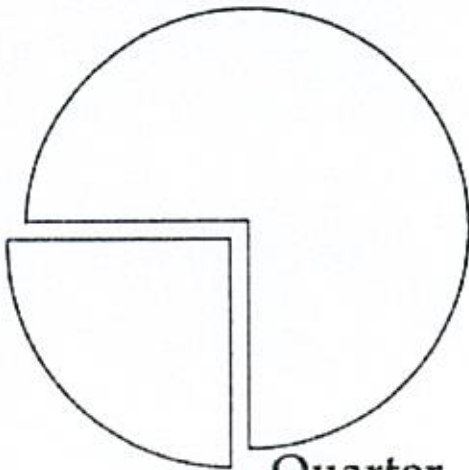

Quarter

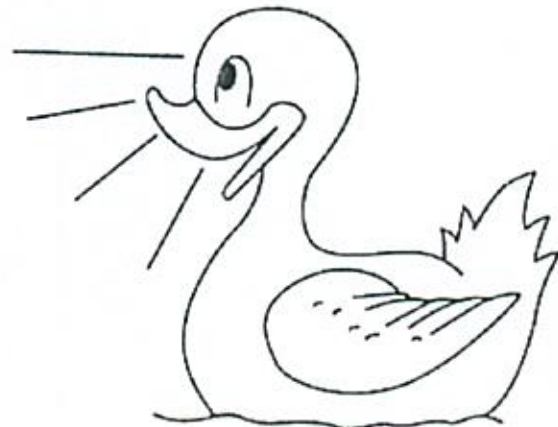

Quack

Thursday

Art Activity

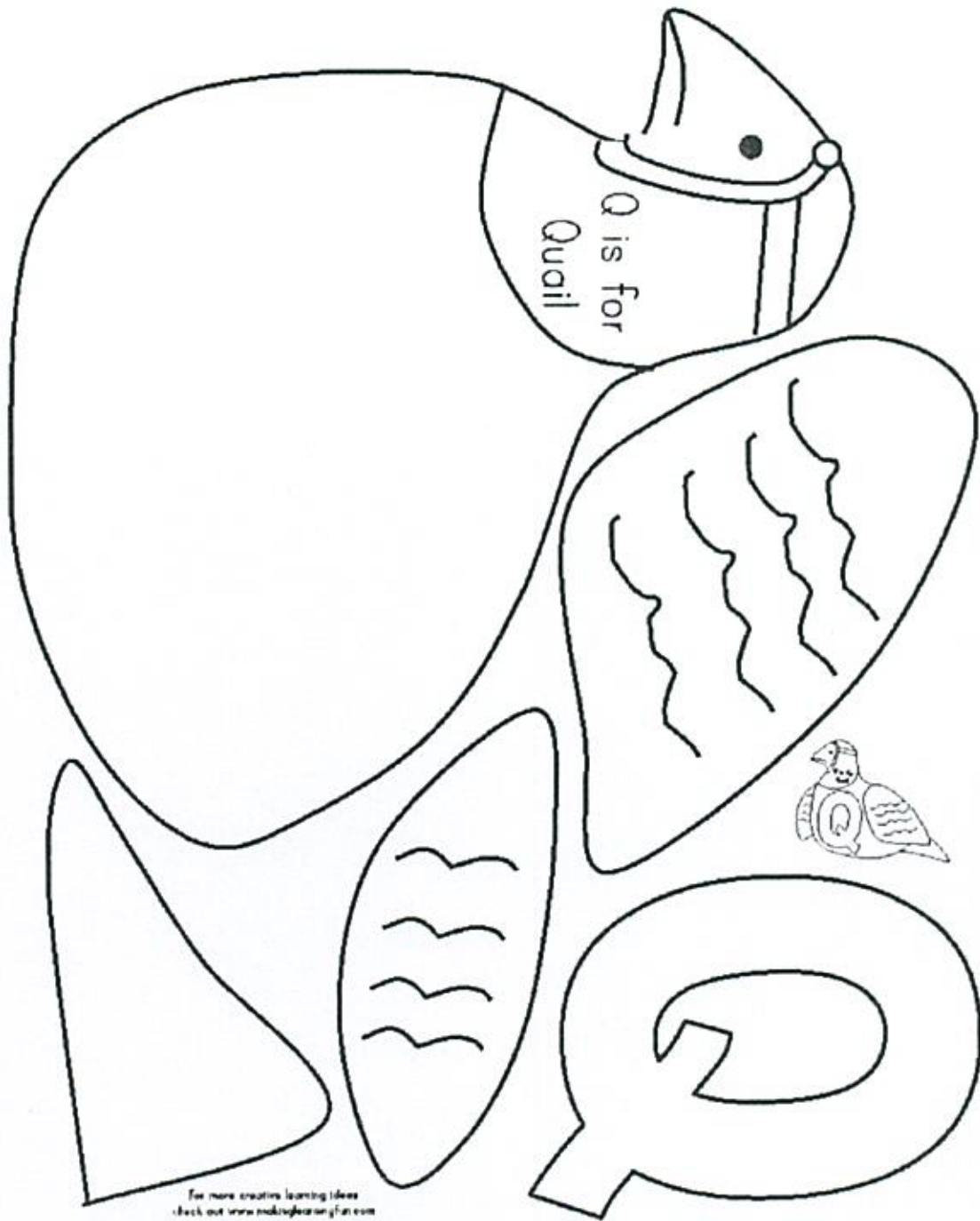

For more creative learning ideas
check out www.makinglearningfun.com

Friday

Name writing sheet

(Let the child write his/her name at the top and then on Saturday and Sunday let them write their name again)

**L.B.J. & C. Head Start
Children's Sign-in for Home**

Name:

Saturday:

Sunday:

Monday

Song for the letter of the week.

Tuesday

Letter activity sheet

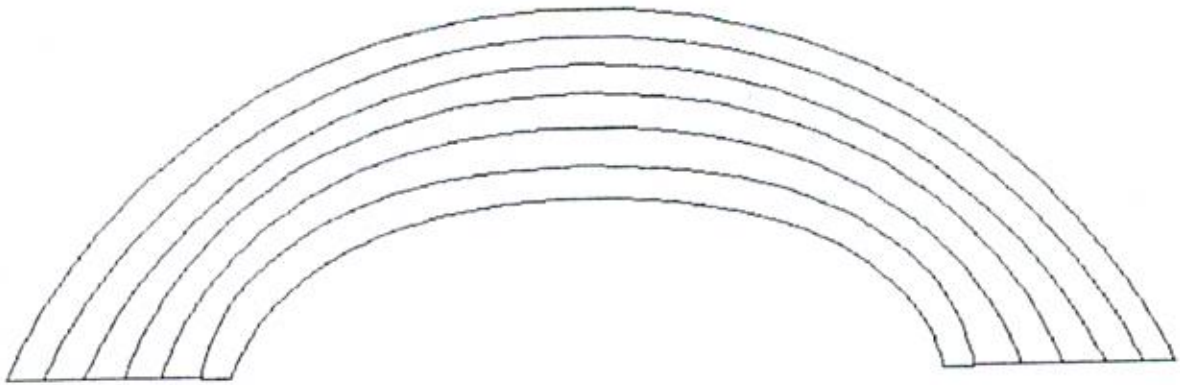

R IS FOR RAINBOW

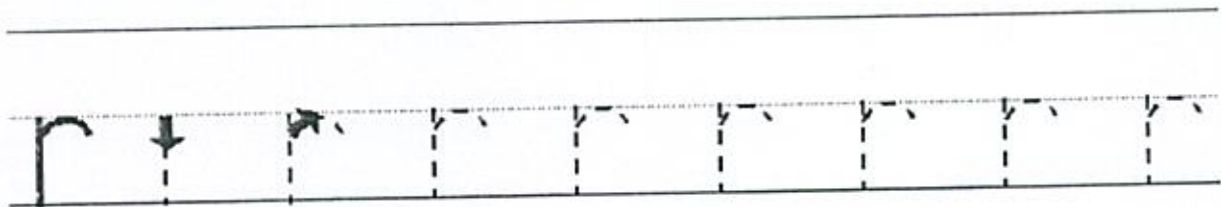
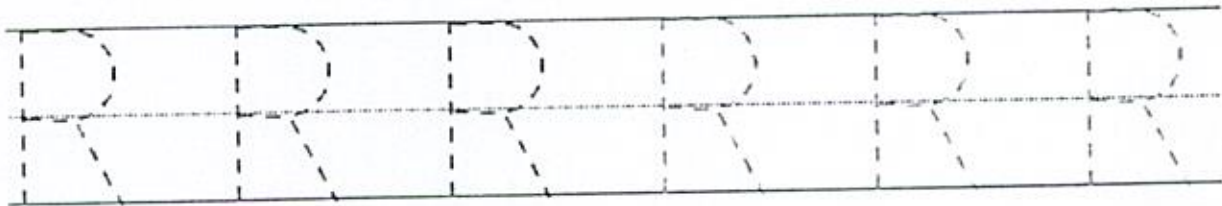
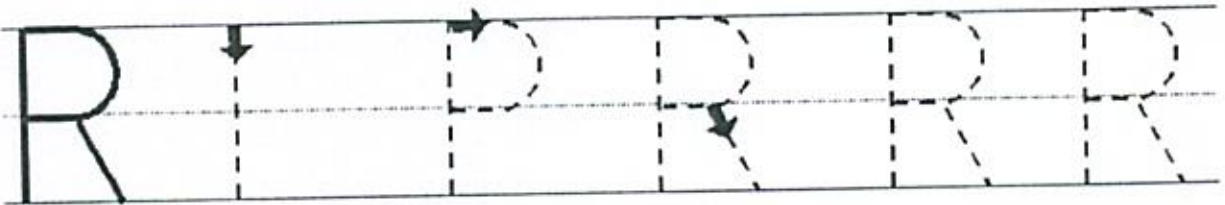

Wednesday

Color Sheet

Rr



Rabbit



Rose

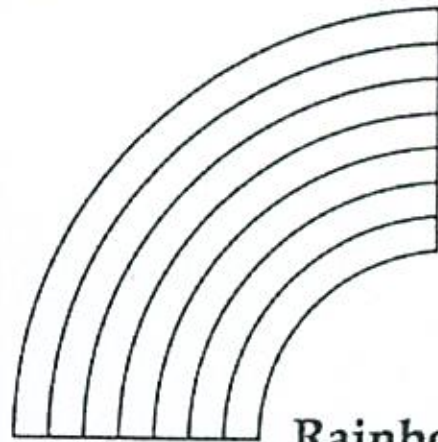

Rainbow

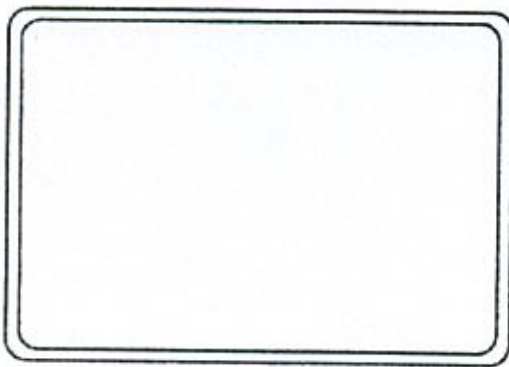

Rectangle

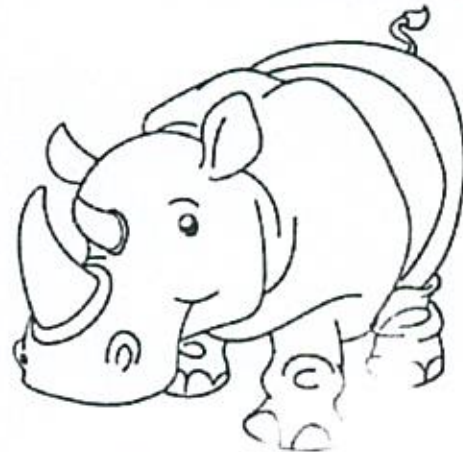

Rhino

Thursday

Art Activity

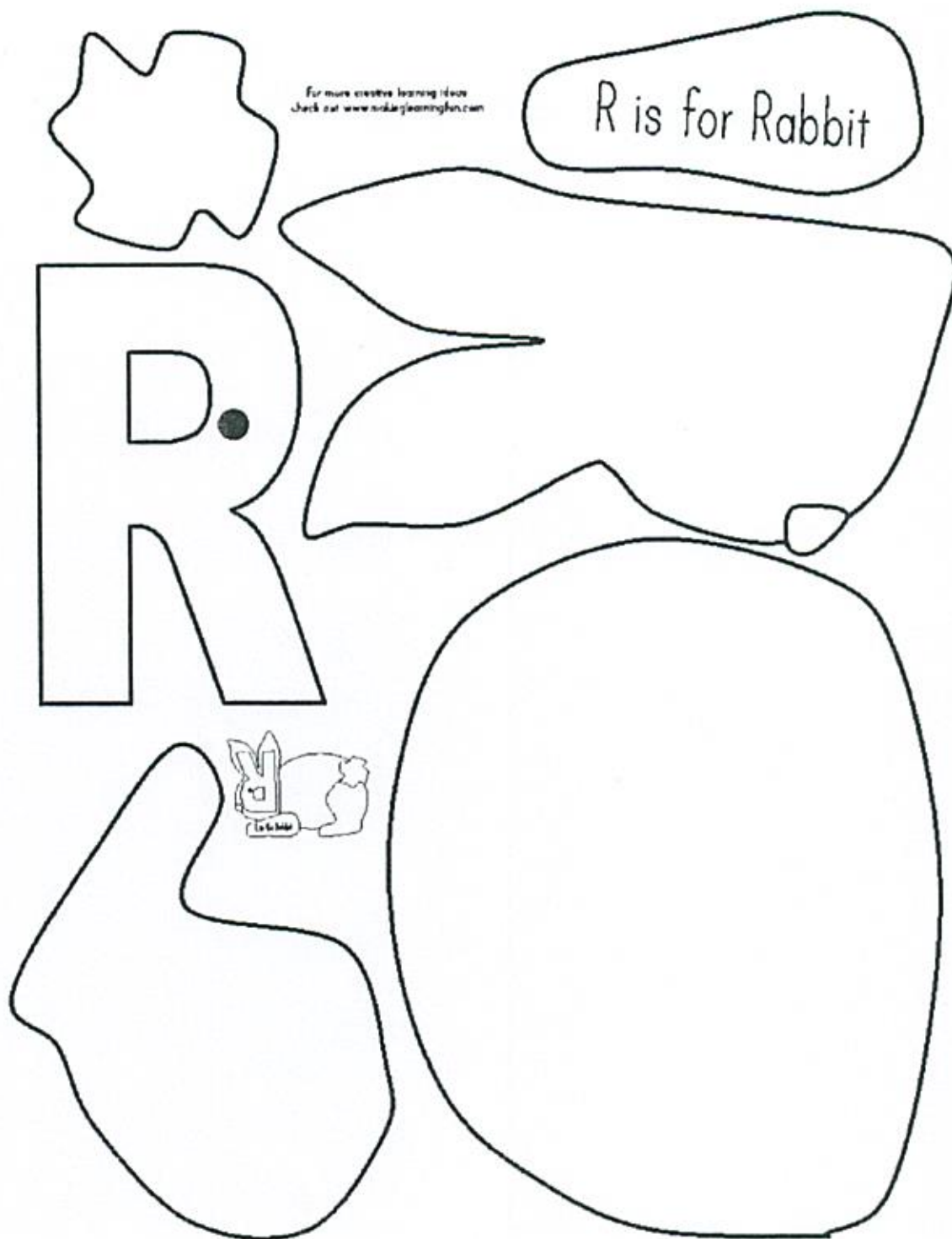

L.B.J. & C. Head Start

Children Sign in for Home

Friday

Name:

Name writing sheet

(Let the child write his/her name at the top and then on
Saturday and Sunday let them write their name again)

Sunday:

Monday

Song for the letter of the week.

Tuesday

Letter activity sheet

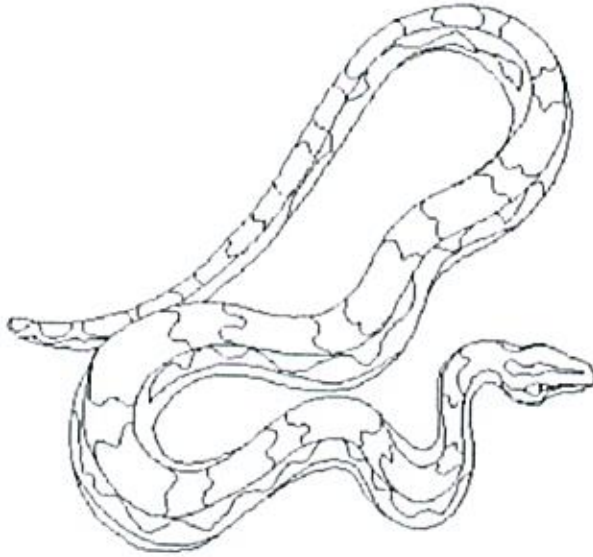

S IS FOR
SNAKE

S S S S S S S

S S S S S S S

S S S S S S S S

S S S S S S S S

Wednesday

Color Sheet

Ss

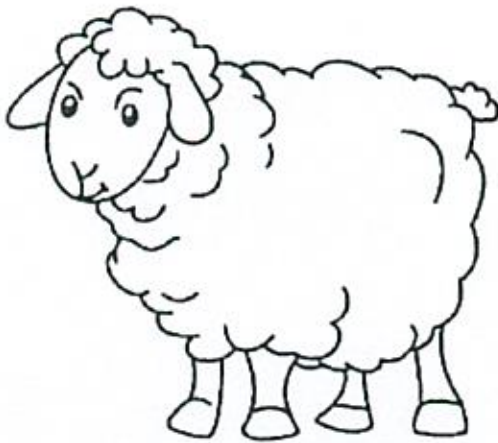

Sheep

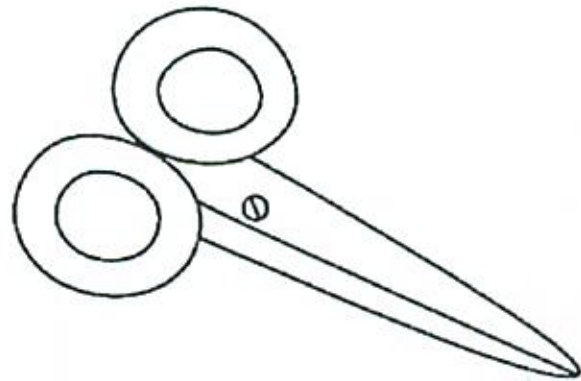

Scissors



Snail



Shoe

Thursday

Art Activity

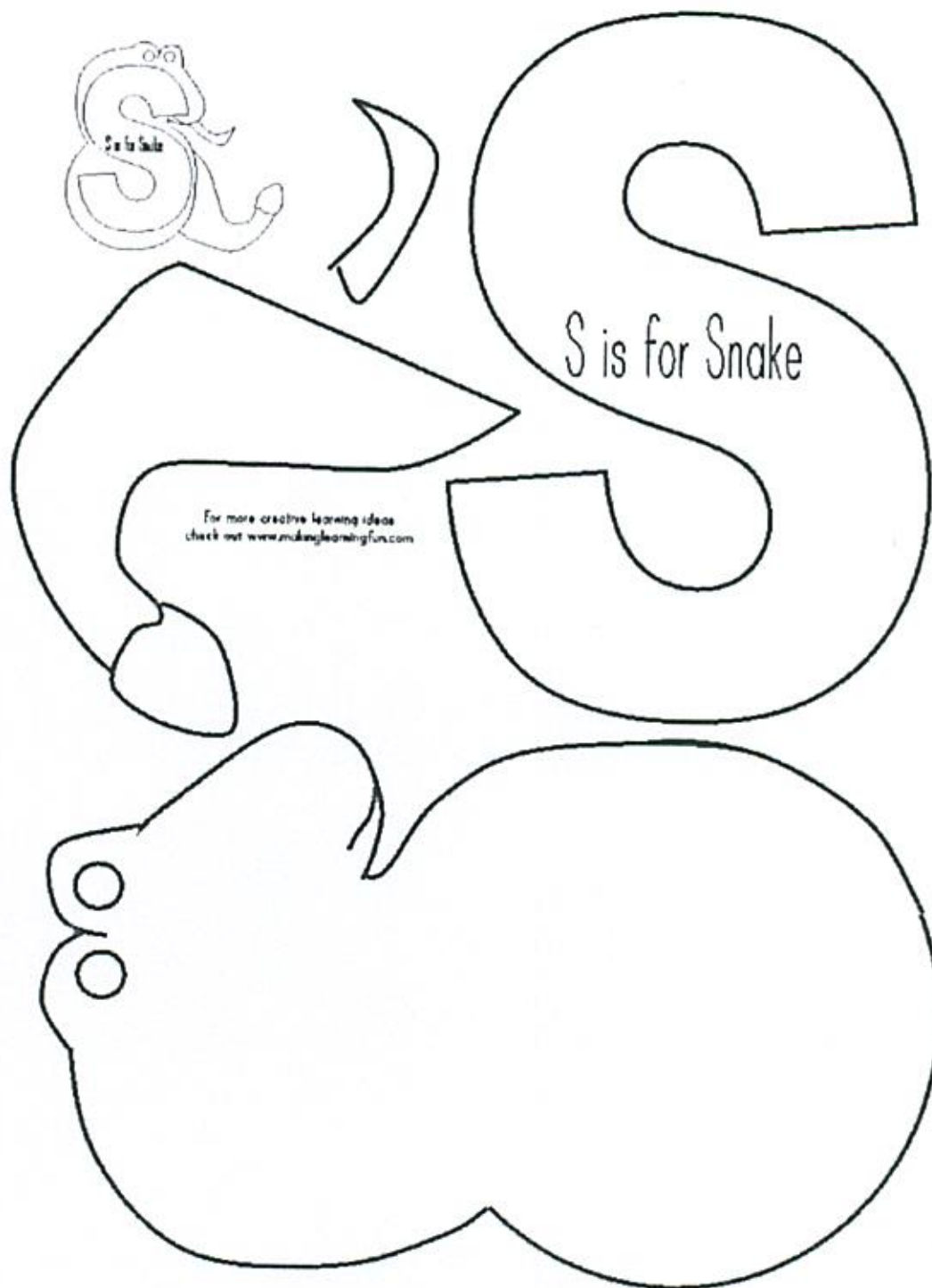

Friday

Name writing sheet

(Let the child write his/her name at the top and then on Saturday and Sunday let them write their name again)

**L.B.J. & C. Head Start
Children's Sign-in for Home**

Name:

Saturday:

Sunday:

Monday

Song for the letter of the week.

Tuesday

Letter activity sheet



T IS FOR
TRUCK

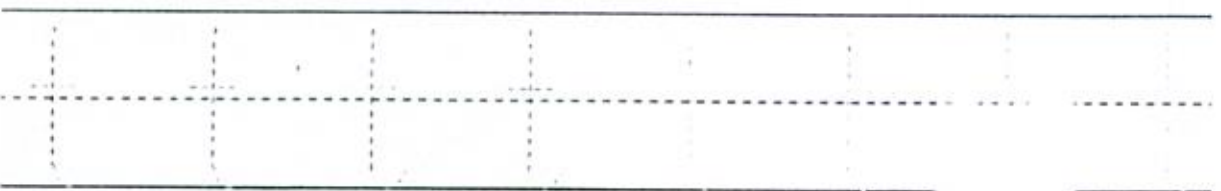
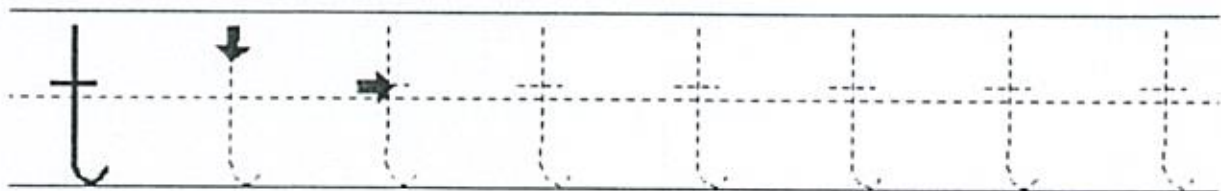
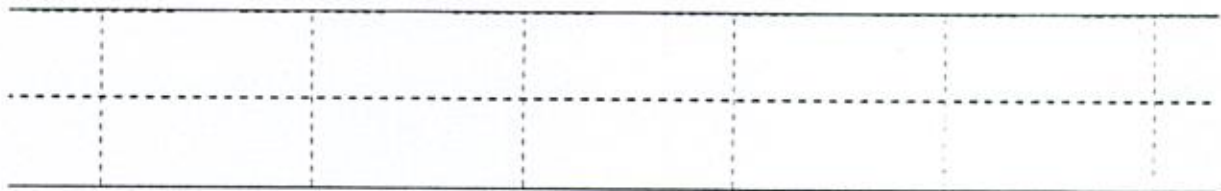
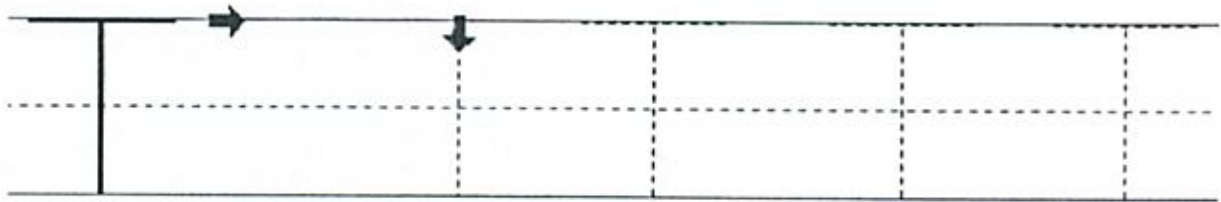

Wednesday

Color Sheet

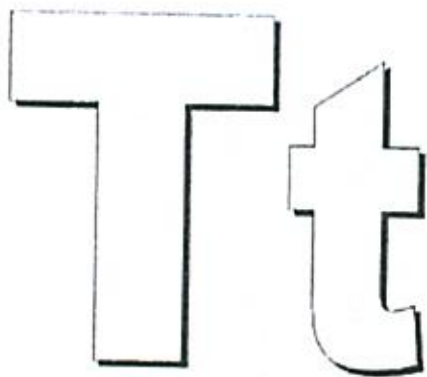

Tiger

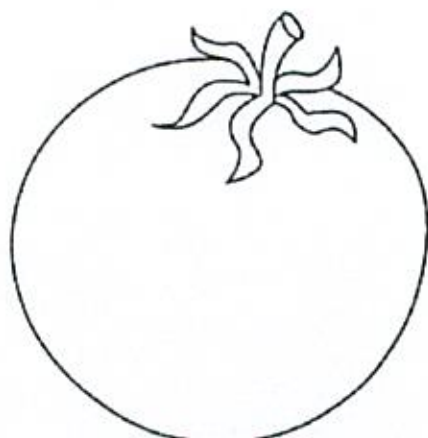

Tomato

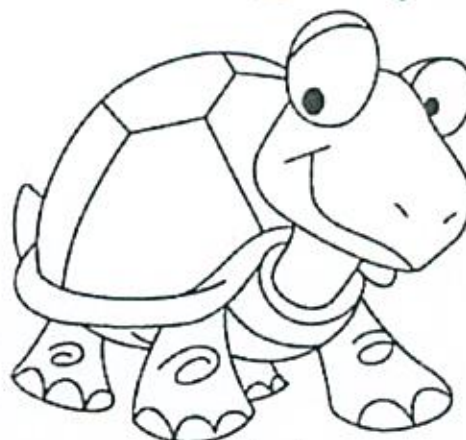

Tortoise



Tulip

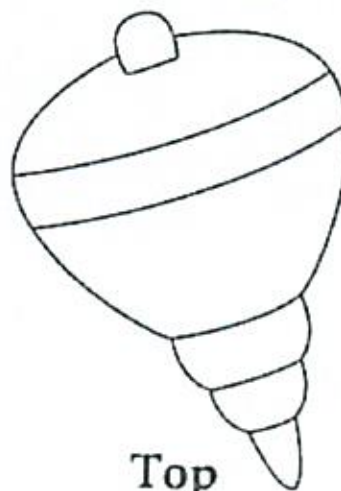

Top

Thursday

Art Activity

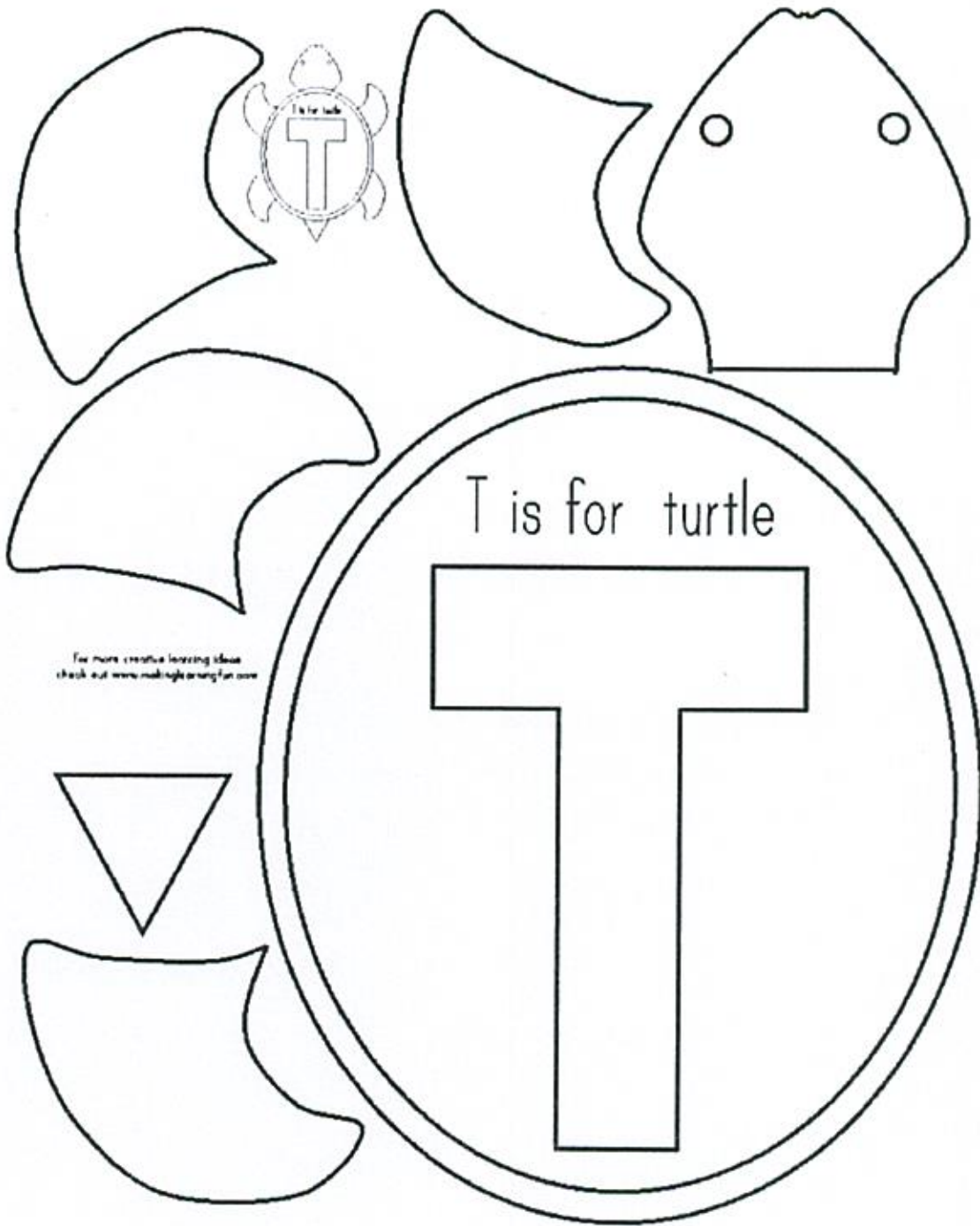

Friday

Name writing sheet

(Let the child write his/her name at the top and then on Saturday and Sunday let them write their name again)

**L.B.J. & C. Head Start
Children's Sign-in for Home**

Name:

Saturday:

Sunday:

Monday

Song for the letter of the week.

Tuesday

Letter activity sheet



U IS FOR
UMBRELLA

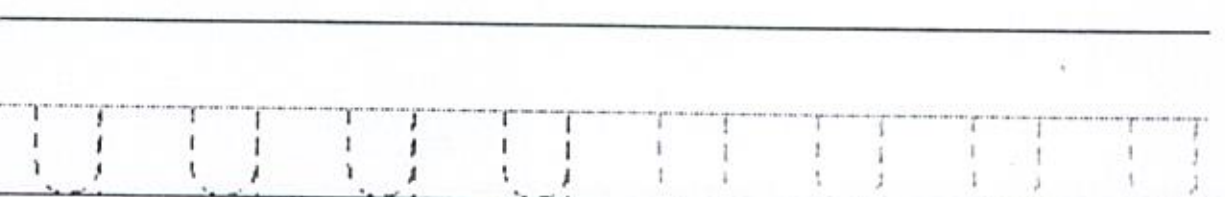
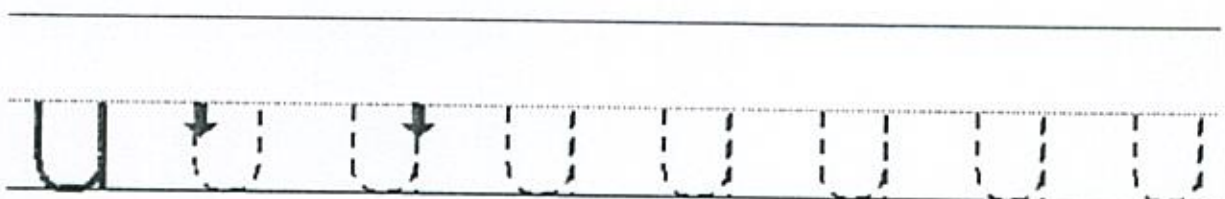
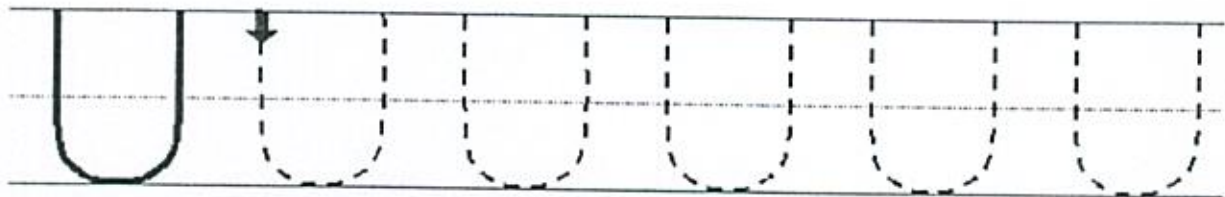

Wednesday

Color Sheet

U u

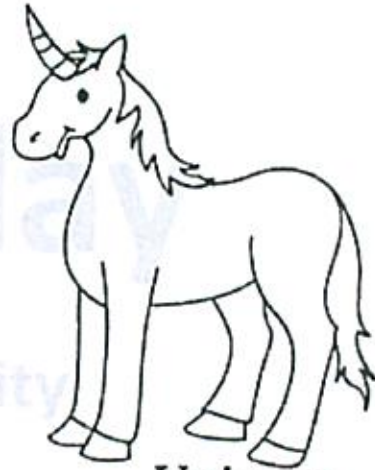

Unicorn



Utensils



Umbrella

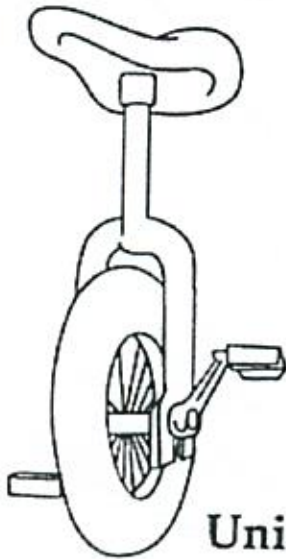

Unicycle



Urn

Friday

Name writing sheet

(Let the child write his/her name at the top and then on Saturday and Sunday let them write their name again)

**L.B.J. & C. Head Start
Children's Sign-in for Home**

Name:

Saturday:

Sunday:

Monday

Song for the letter of the week.

Tuesday

Letter activity sheet



V IS FOR
VOLCANO

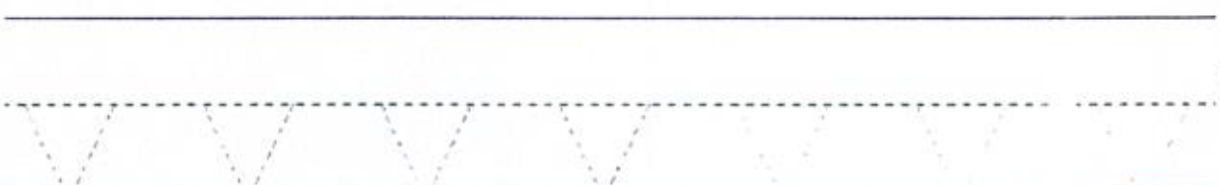
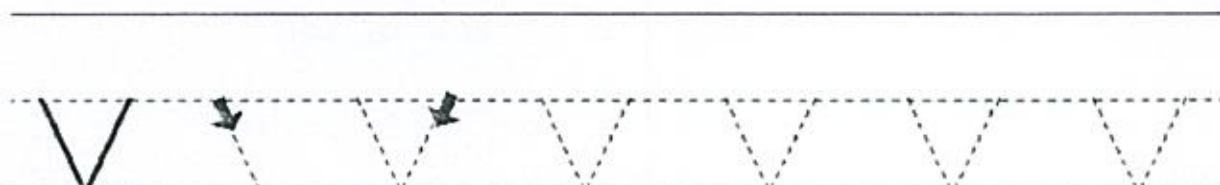
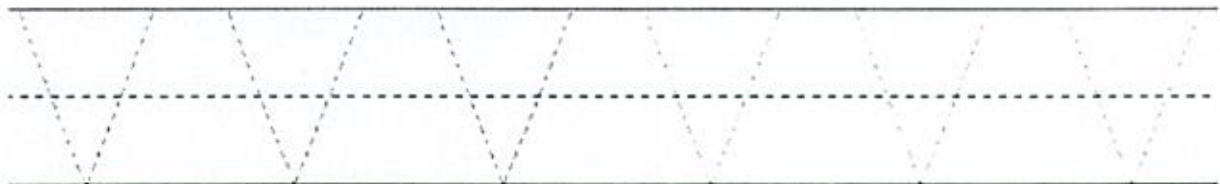
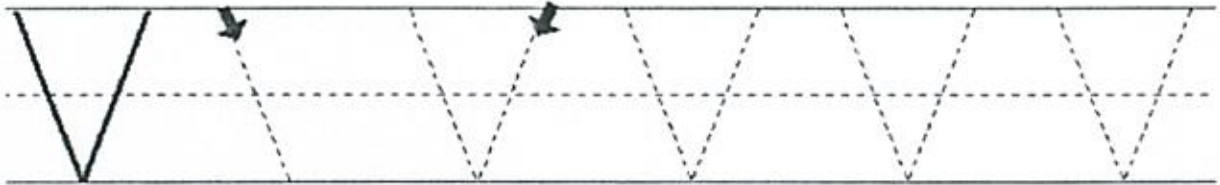

Wednesday

Color Sheet



Vase



Vulture

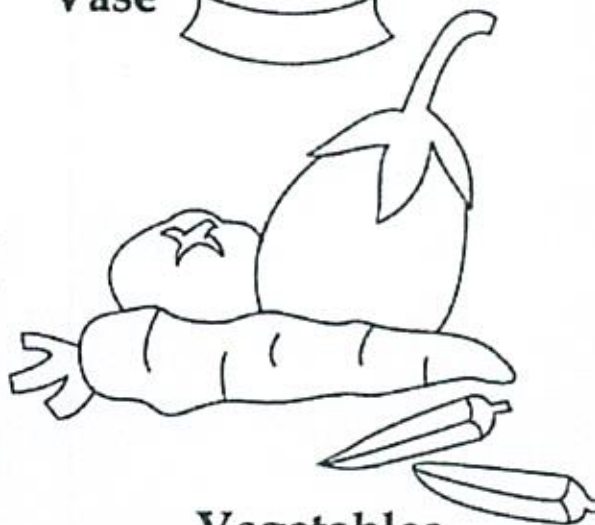

Vegetables

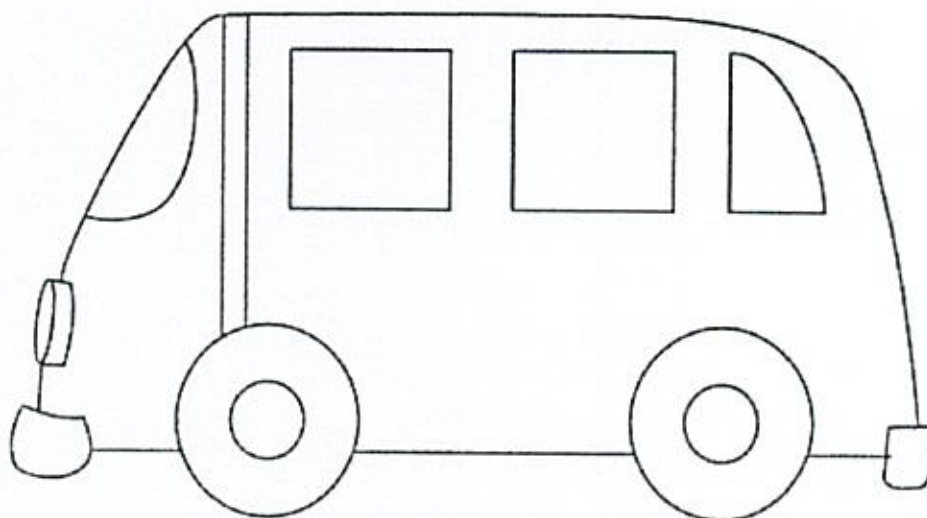

Van

Thursday

Art Activity

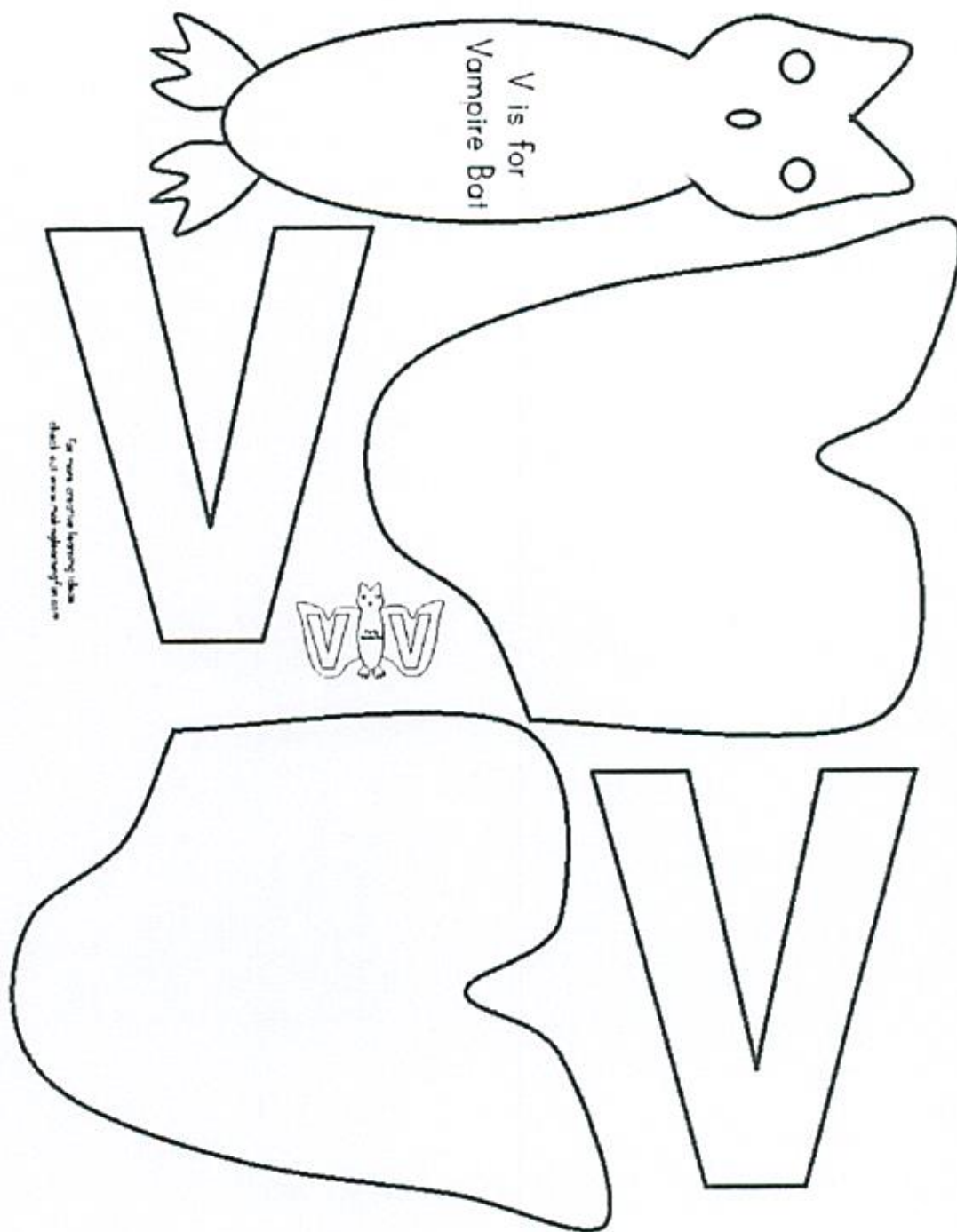

Friday

Name writing sheet

(Let the child write his/her name at the top and then on Saturday and Sunday let them write their name again)

**L.B.J. & C. Head Start
Children's Sign-in for Home**

Name:

Saturday:

Sunday:

Monday

Song for the letter of the week.

XXXXXXXXXXXXXXXXXXXXXXXXXXXXXXXXXXXXXXXXXXXX

Willie and Wanda

TUNE: ON TOP OF OLD SMOKEY

Willie the walrus wanted a wife,
To have and to hold for the rest of his life.
He went down to Walrus-Mart to buy him a sink.
There he saw Wanda and he gave her a wink.
She was wild about Willie.
It was love at first sight.
They planned a big wedding,
And were married that night.
We served watermelon, and all worked out fine.
And they lived life together, 'til they were ninety-nine.

The End



XXXXXXXXXXXXXXXXXXXXXXXXXXXXXXXXXXXXXXXXXXXX

Tuesday

Letter activity sheet

W IS FOR WHALE

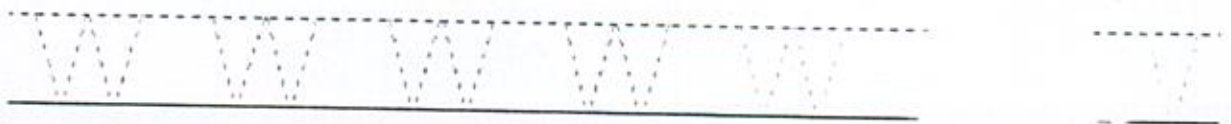
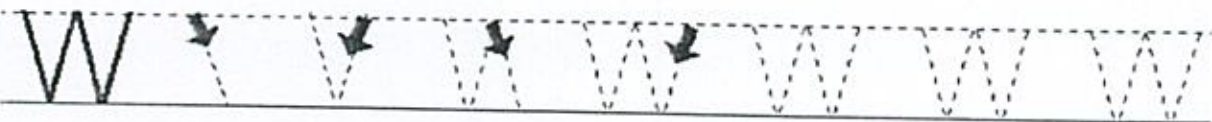
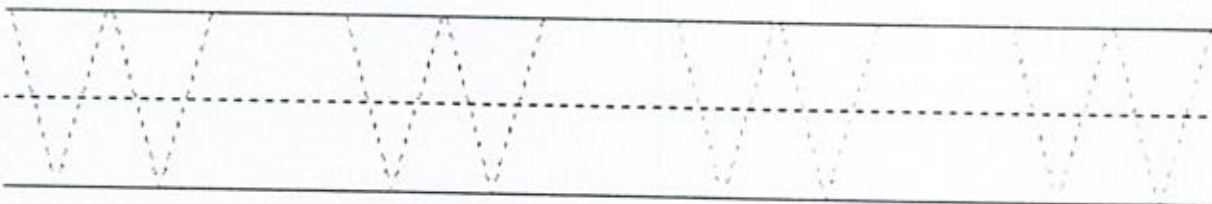
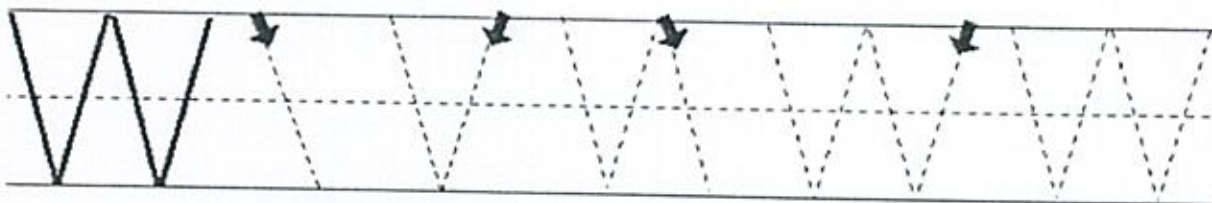
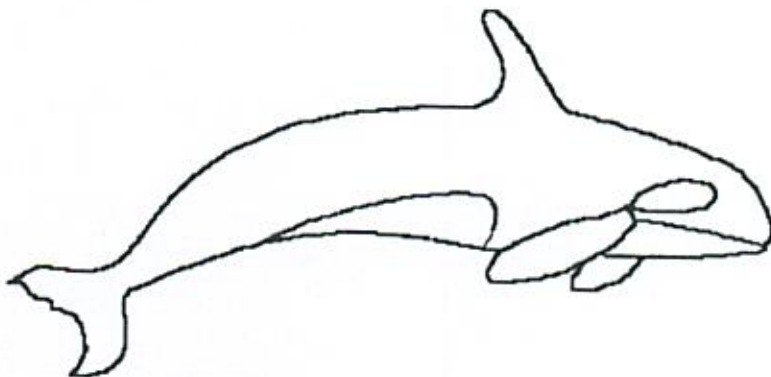

Wednesday

Color Sheet

Ww

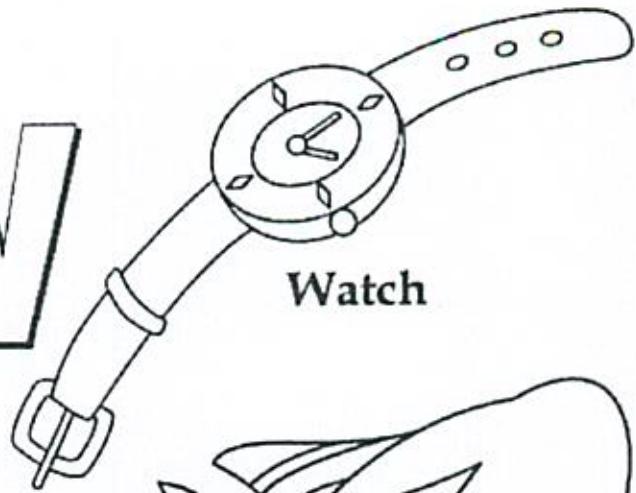

Watch

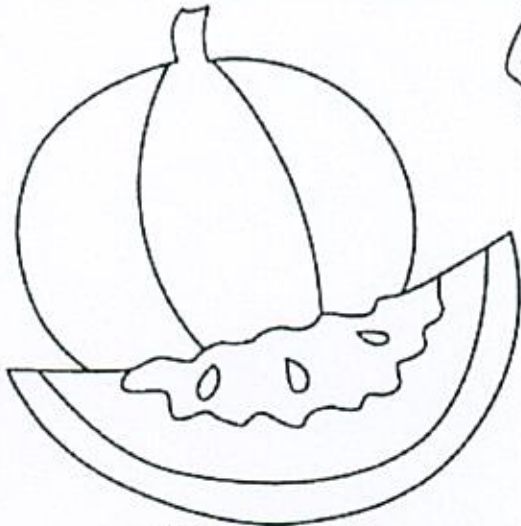

Watermelon



Whale



Wolf

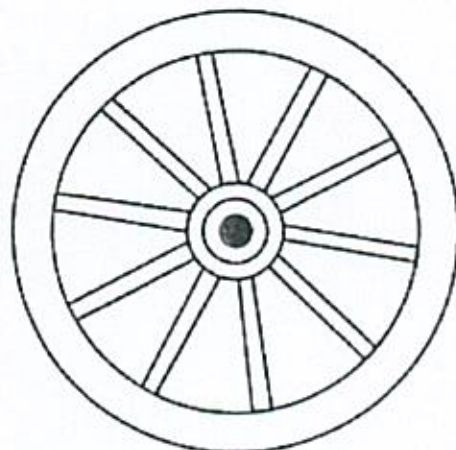

Wheel

Thursday

Art Activity

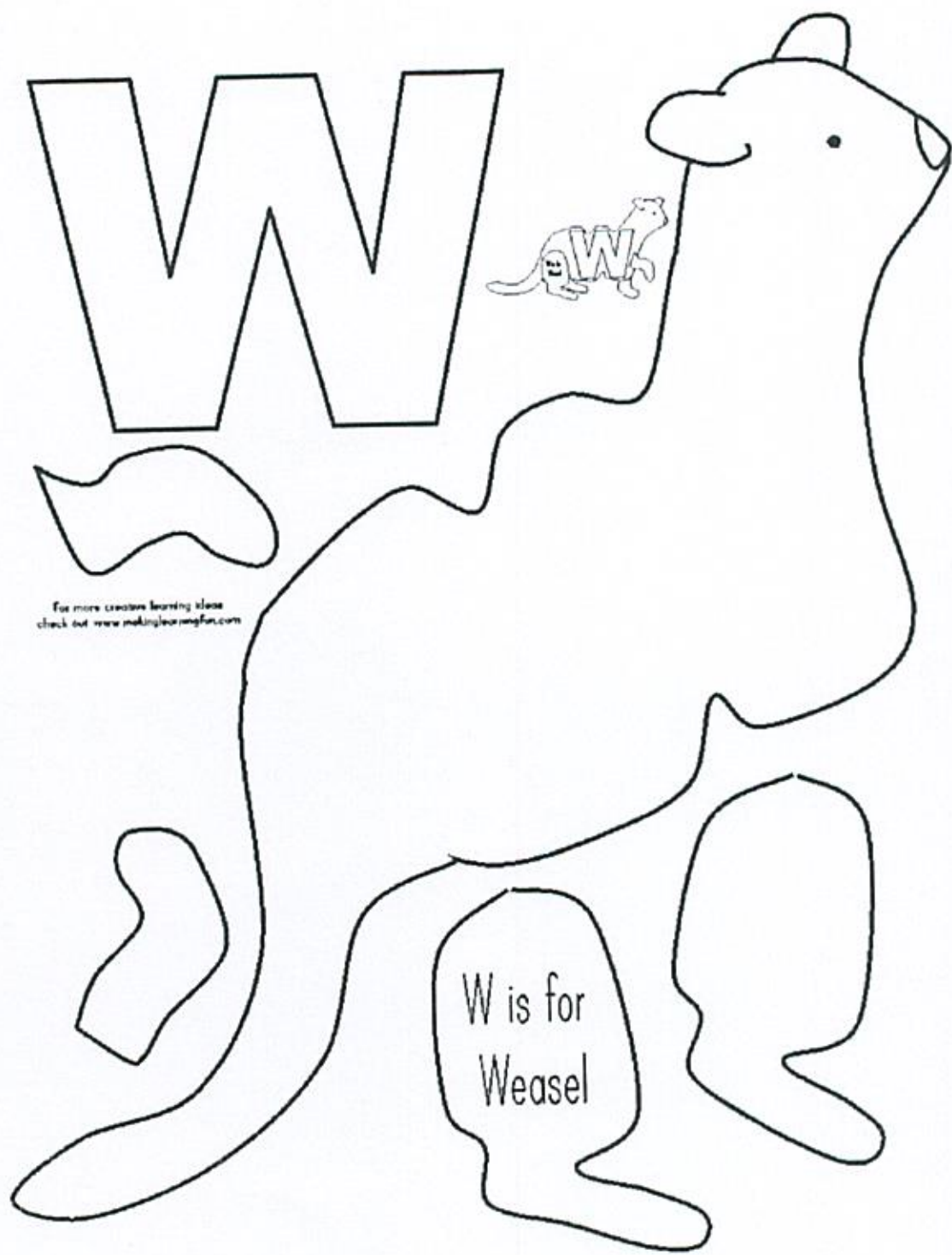

For more creative learning ideas
check out www.makinglearningfun.com

Friday

Name writing sheet

(Let the child write his/her name at the top and then on Saturday and Sunday let them write their name again)

**L.B.J. & C. Head Start
Children's Sign-in for Home**

Name:

Saturday:

Sunday:

Monday

Song for the letter of the week.

Tuesday

Letter activity sheet



X IS FOR

X-RAY

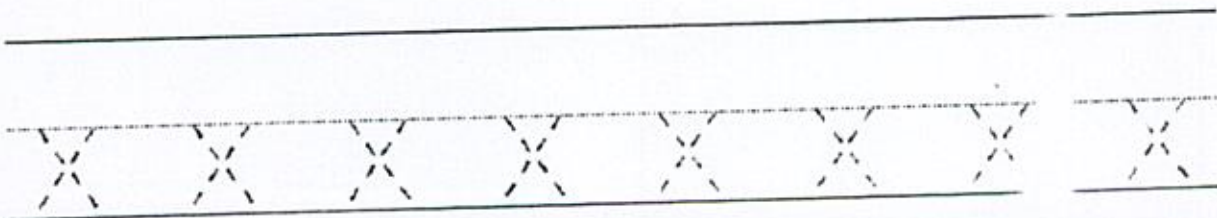
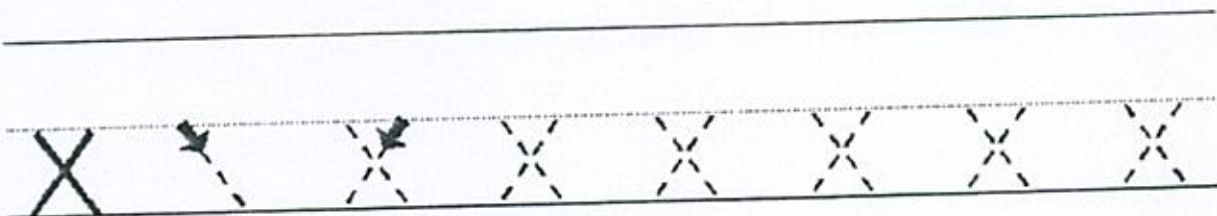
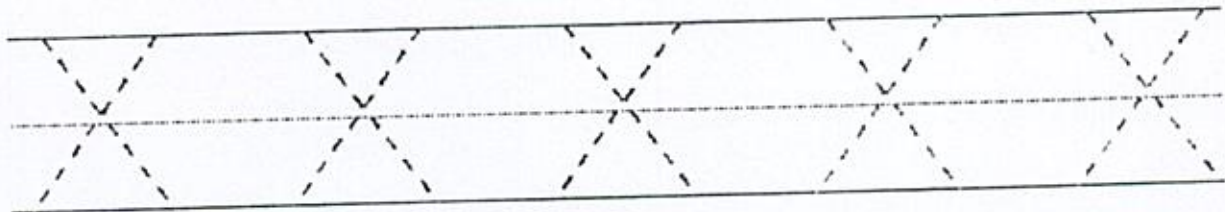
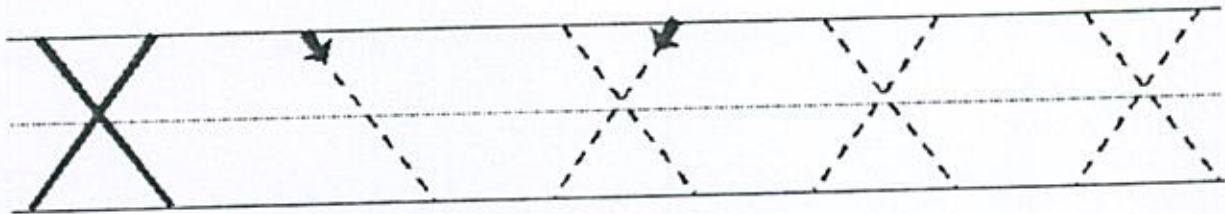

Wednesday

Color Sheet

Xx

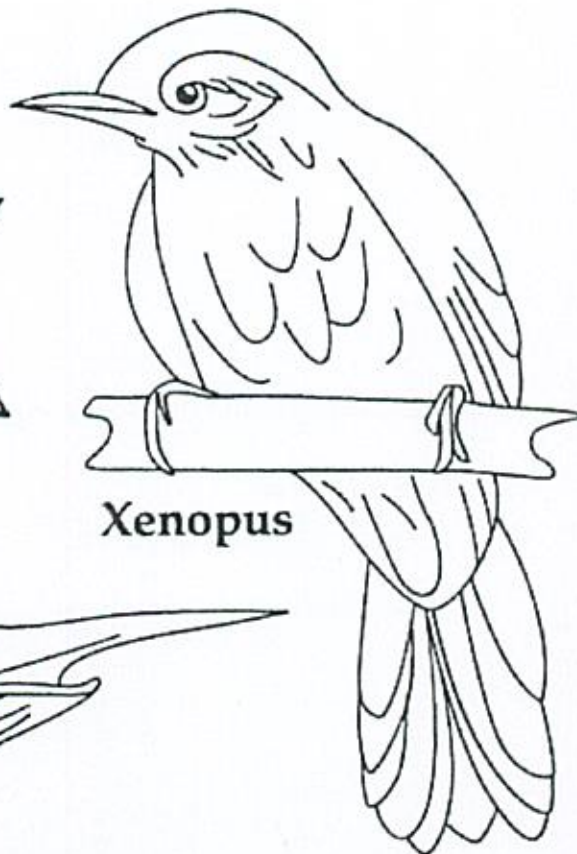

Xenopus

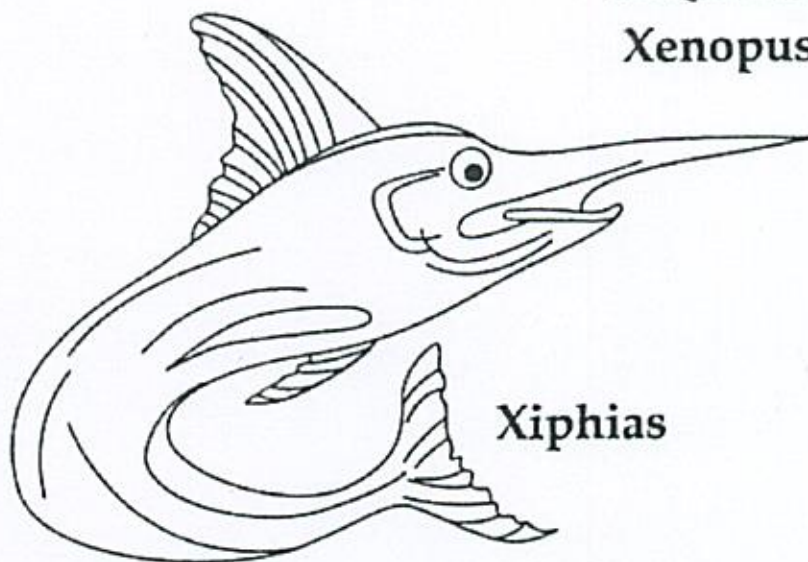

Xiphias

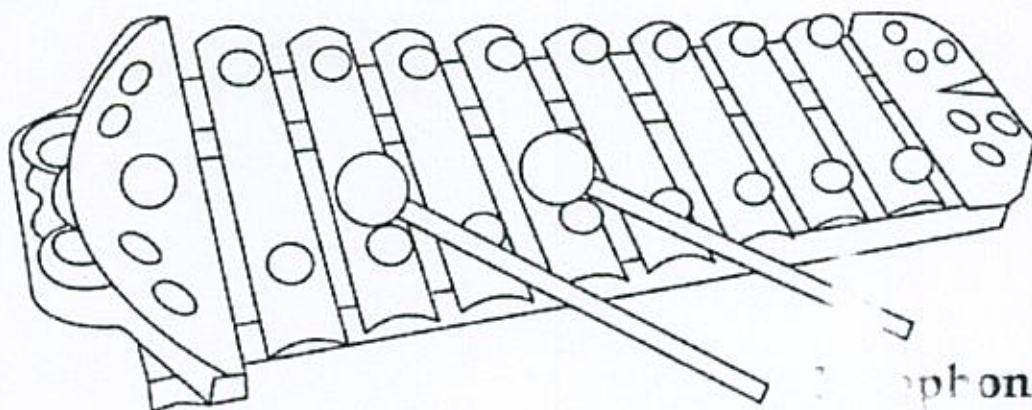

Xylophone

Thursday

Art Activity

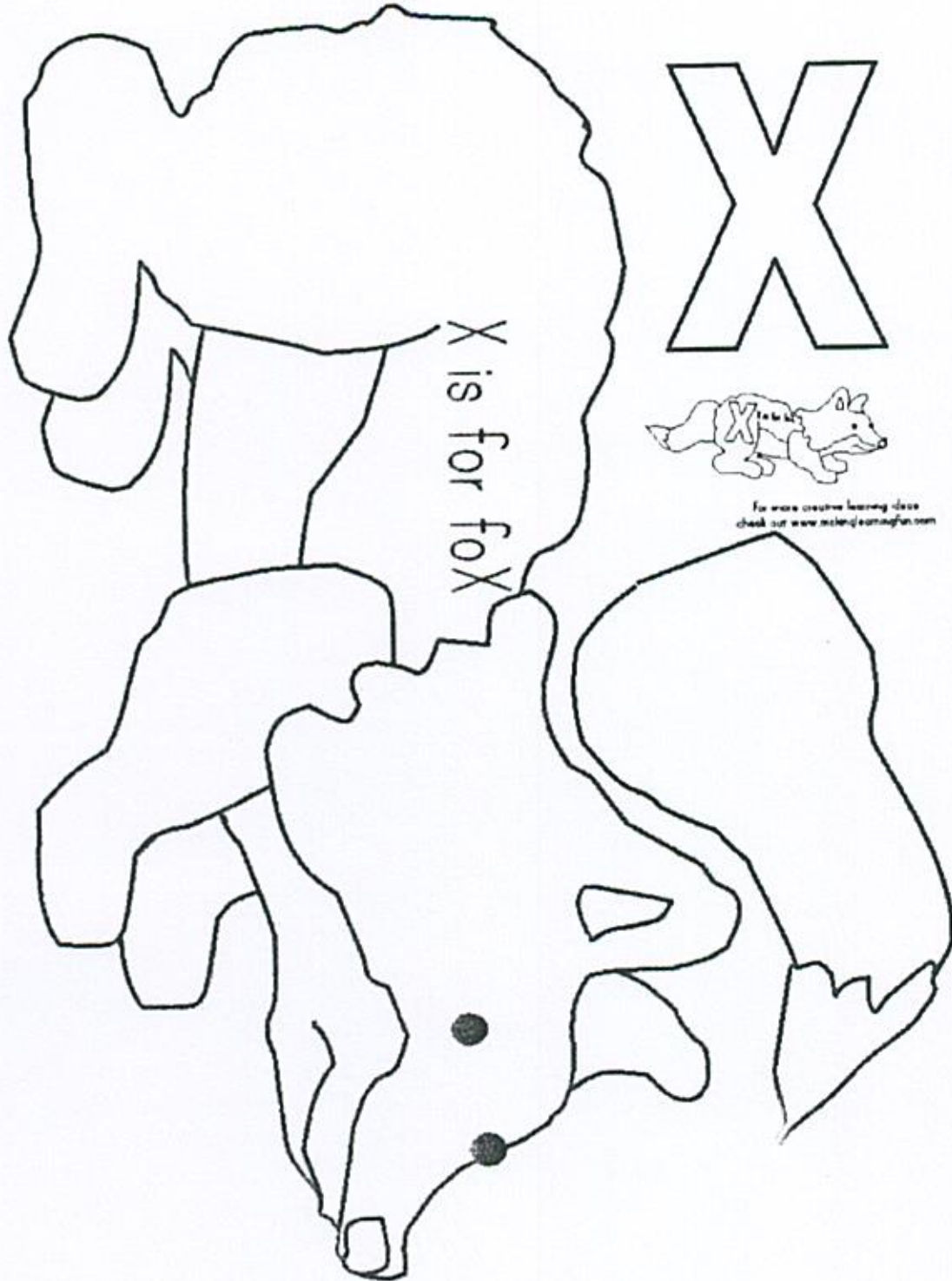

Friday

Name writing sheet

(Let the child write his/her name at the top and then on Saturday and Sunday let them write their name again)

**L.B.J. & C. Head Start
Children's Sign-in for Home**

Name:

Saturday:

Sunday:

Monday

Song for the letter of the week.

Tuesday

Letter activity sheet

Y IS FOR YACHT

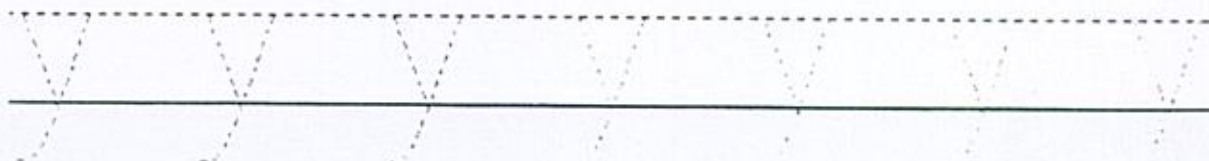
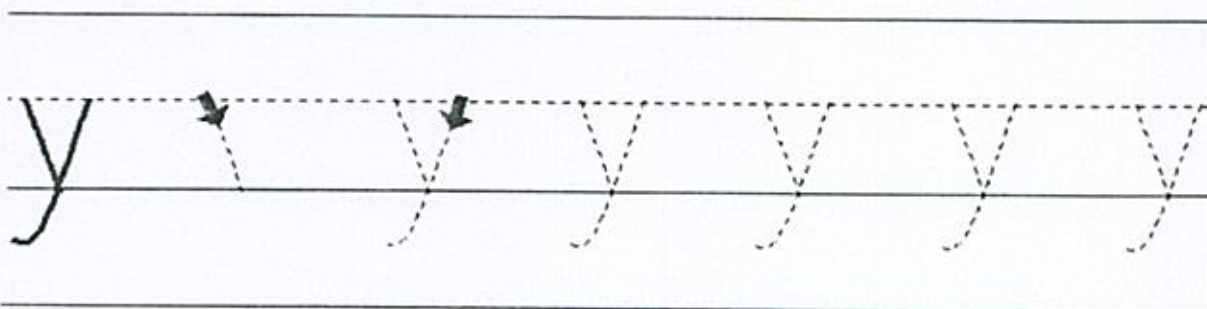
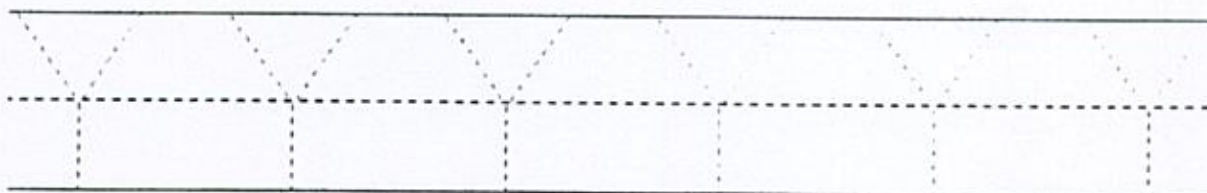
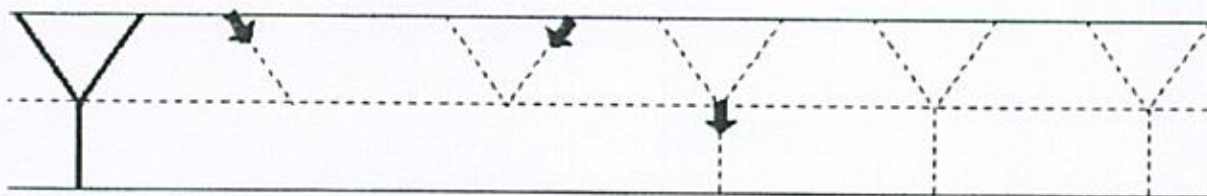
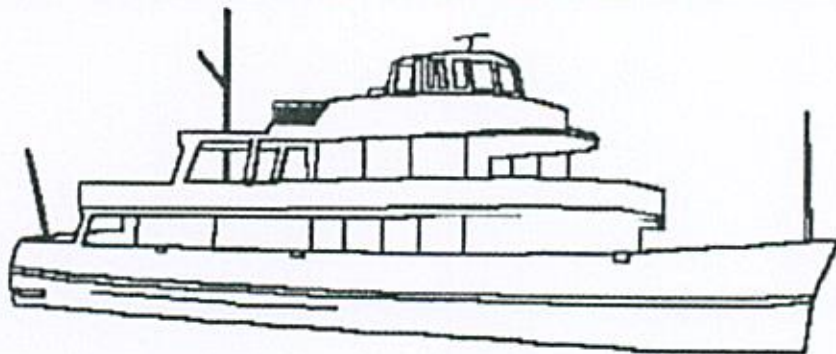

Wednesday

Color Sheet



Yo-yo

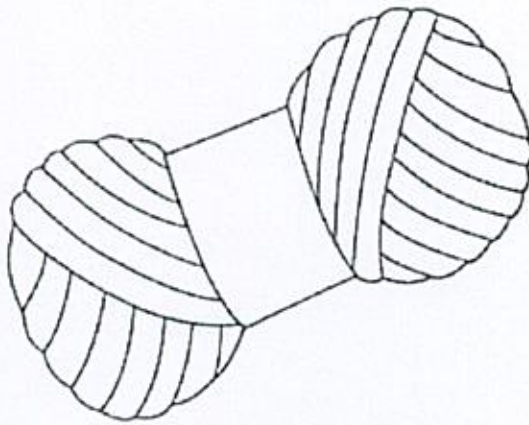

Yarn



Yacht



Yak

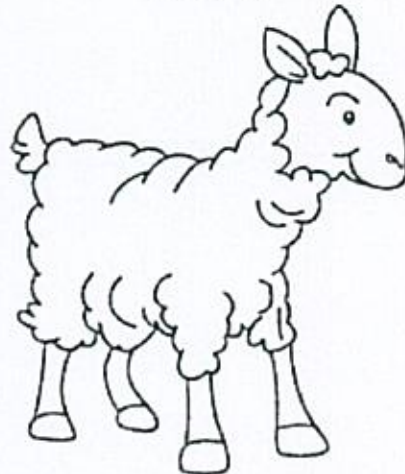

Yeanling

Thursday

Art Activity

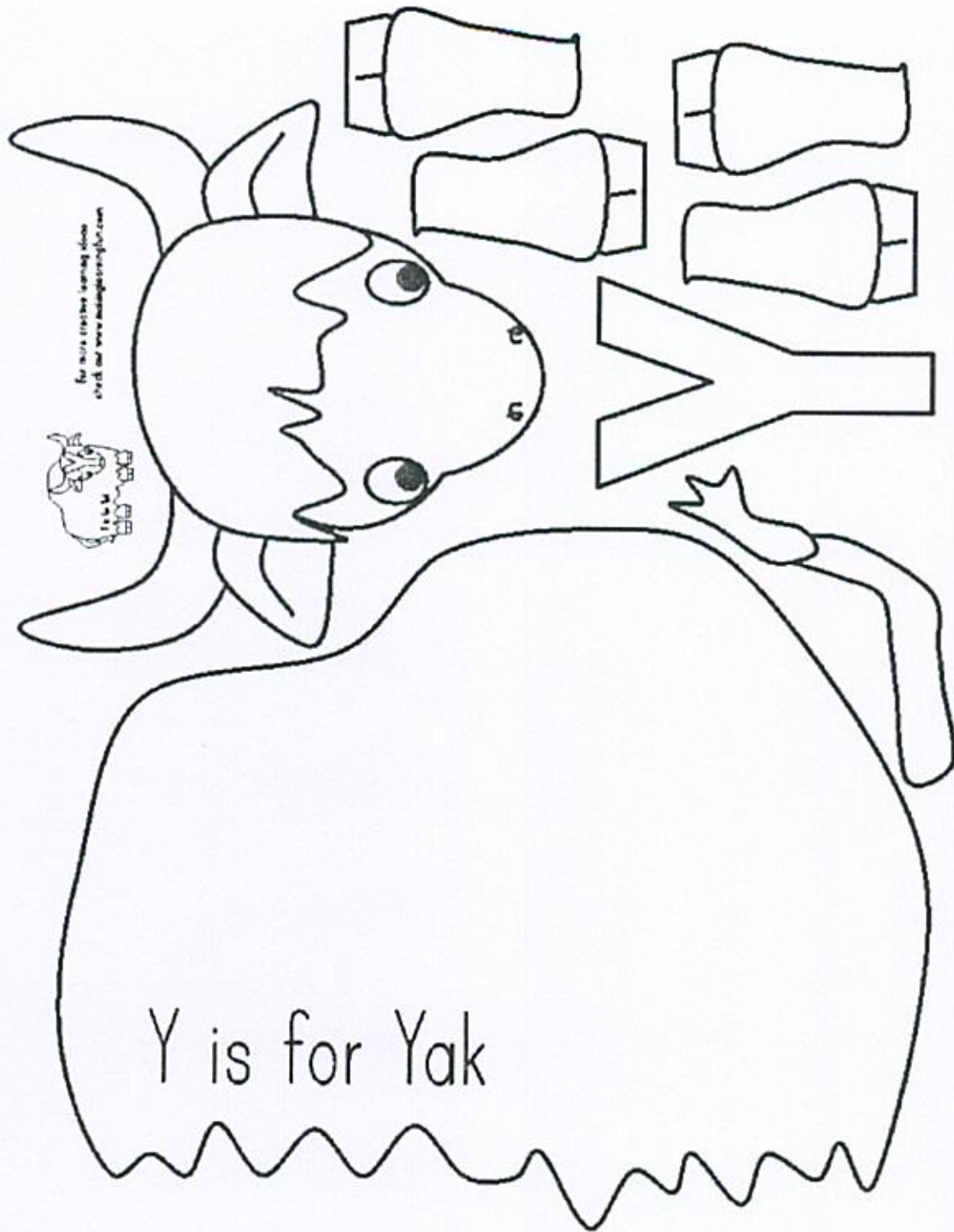

Friday

Name writing sheet

(Let the child write his/her name at the top and then on Saturday and Sunday let them write their name again)

**L.B.J. & C. Head Start
Children's Sign-in for Home**

Name:

Saturday:

Sunday:

Monday

Song for the letter of the week.

Tuesday

Letter activity sheet

Z IS FOR
ZEBRA

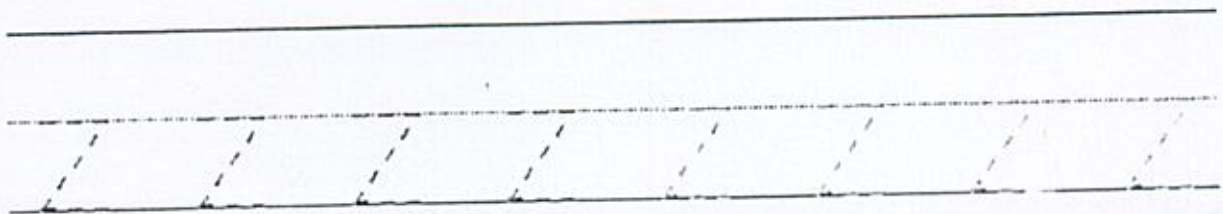
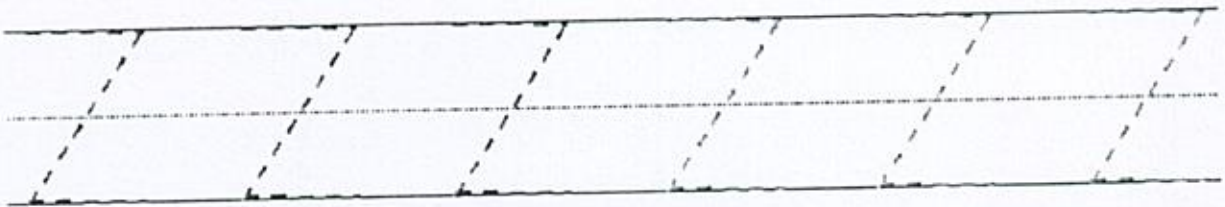
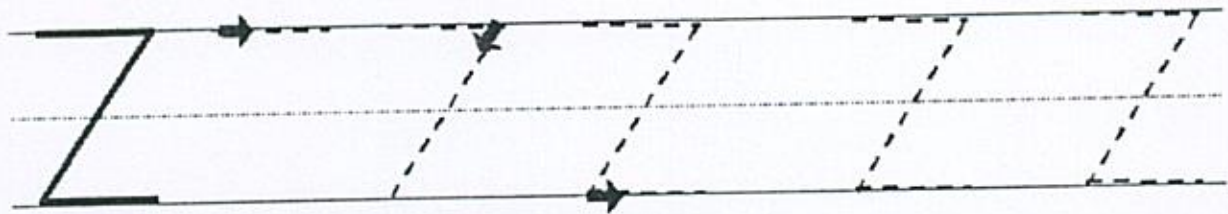
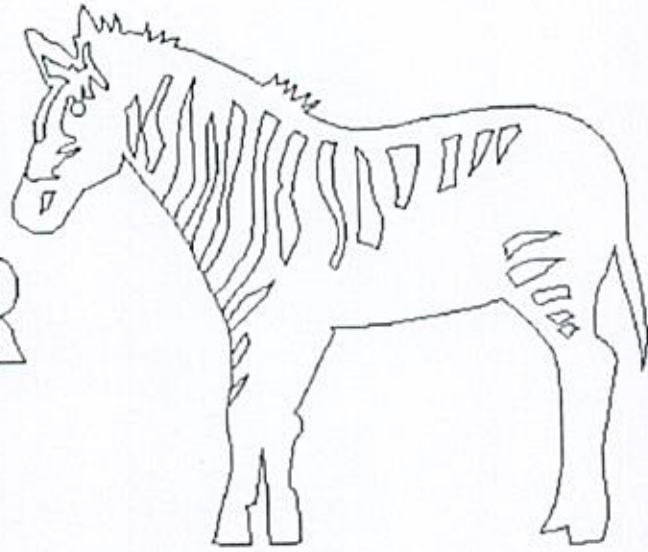

Wednesday

Color Sheet



Zebra

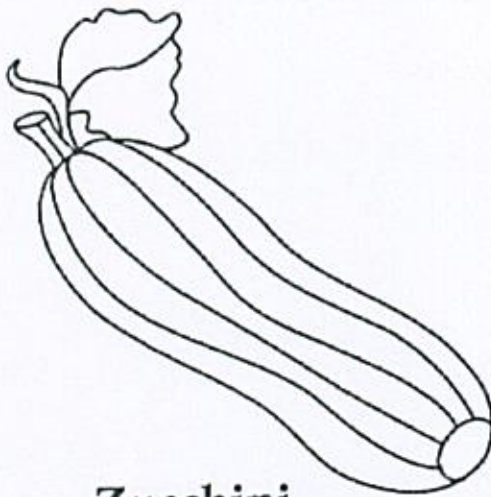

Zucchini



Zinnia

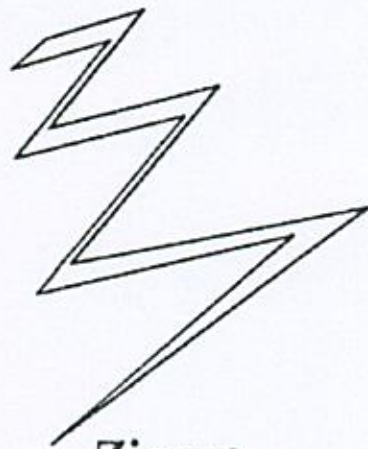

Zigzag

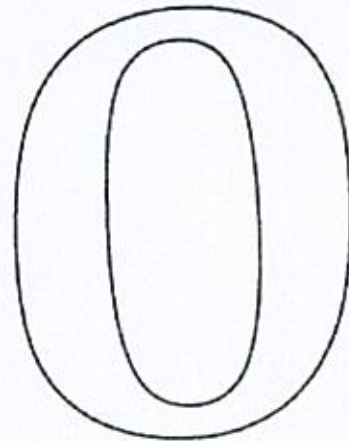

Zero

Thursday

Art Activity



for more creative learning ideas
check out www.makinglearningfun.com

Friday

Name writing sheet

(Let the child write his/her name at the top and then on Saturday and Sunday let them write their name again)

**L.B.J. & C. Head Start
Children's Sign-in for Home**

Name:

Saturday:

Sunday:
