

Super Clean Technology

Micro Weld Fitting
Tube Butt Weld Fitting
Face Seal Fitting



Super Clean Technology

Super Clean Technology

Super Clean Technology

Index

- 3 / Ordering Instructions**
- 5 / Micro Weld Fitting**
- 7 / Tube Butt Weld Fitting**
- 7 / Automatic Tube Weld Fitting**
- 9 / Automatic Socket Weld Fitting**
- 10 / Face Seal Fitting**
 - 11 / Glands
 - 16 / Welded Assemblies
 - 17 / Gaskets
 - 17 / Nuts, Caps, and Plugs
 - 18 / High-Flow Connections - "H" Type
 - 19 / Handling

Ordering Instructions

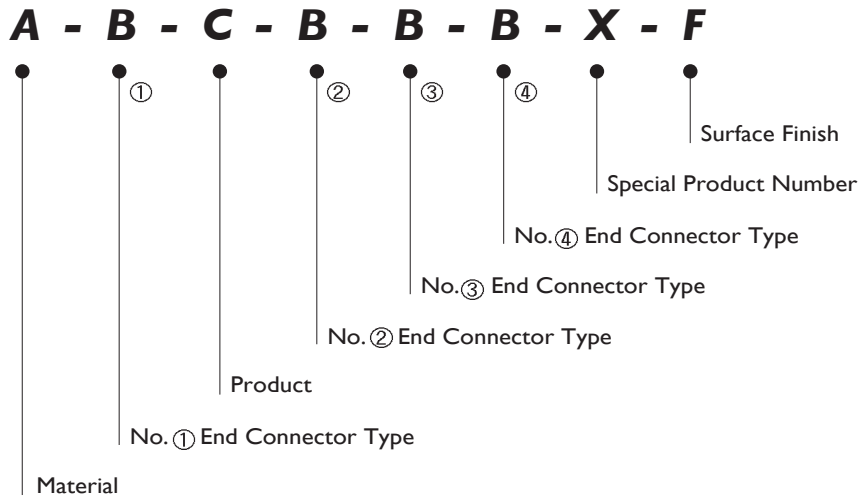

For tees, the run(① to ②) shall precede the branch(③).

For crosses, the run(① to ②) shall precede the branch(③ to ④).

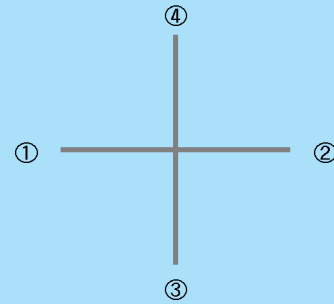

A. Material Designator

Identifier	Material	Identifier	Material
SM	Single Melt 316L Stainless Steel	NI	Nickel
DM	Double Melt 316L Stainless Steel	SN	Silver Plated Nickel
SL	316L Stainless Steel	SP	316 Stainless Steel
SS	Silver Plated Stainless Steel		

B. End Connector Type

Size		Connector Type		Length	
Identifier	Size	Identifier	Connector Type	Identifier	Length
1	1/16"	T	Tube Butt Weld	1	6.4mm
2	1/8"	A	Automatic Tube Butt Weld	2	9.6mm
4	1/4"	S	Socket Weld	3	19.1mm
6	3/8"	TM	Manual Tube Butt Weld	4	24.4mm
8	1/2"	N	NPT	5	7.1mm
12	3/4"	NF	NPT - Female	6	10.4mm
16	1"	NS	NPT - Straight Thread O - Ring	7	11.4mm
6M	6mm	P	PT	8	12.7mm
8M	8mm	PF	PT - Female	9	15.7mm
10M	10mm	PS	PT - Straight Thread O - Ring	10	20.6mm
12M	12mm	V	Face Seal Fitting (VCR) Male Type	11	25.4mm
18M	18mm	VF	Face Seal Fitting (VCR) Female Type	12	28.4mm
		KM	Superlok Male Type		
		K	Superlok Female Type		

C. Product

Identifier	Material	Identifier	Material
LG	Long Gland	CP	Cap
SG	Short Gland	PG	Plug
BG	Blind Gland	HG	High Flow Gland
CB	Connector Body	HCB	High Flow Connector Body
UB	Union Body	HBCB	High Flow Bulkhead Connector Body
PB	Coupling Body	HBUB	High Flow Bulkhead Union Body
AB	Adapter Body	HUEB	High Flow Union Elbow Body
BB	Bushing Body	HUTB	High Flow Union Tee Body
CEB	Connector Elbow Body	HFN	High Flow Female Nut
CTB	Connector Tee Body	HMN	High Flow Male Nut
UEB	Union Elbow Body	TA	Tube Adapter
UTB	Union Tee Body	LA	Locator Tube Adapter
UCB	Union Cross Body	E	Elbow
CW	Connector Weld Assembly	T	Tee
UW	Union Weld Assembly	CT	Cross Tee
UEW	Union Elbow Weld Assembly	TB	Tribow
UTW	Union Tee Weld Assembly	R	Reducer
UCTW	Union Cross Tee Weld Assembly	ME	Micro Elbow
NR	Non - Retained Style Gasket	MHE	Micro Half Elbow
GR	Gasket Retainer Assembly	MT	Micro Tee
RG	Retainer Style Gasket	MCT	Micro Cross Tee
FN	Female Nut	MTB	Micro Tribow
MN	Male Nut	MR	Micro Reducer
SMN	Short Male Nut	CE	Cube Elbow
BC	Bulkhead Connector Body	CT	Cube Tee
BSC	Bulkhead Short Connector Body	CCT	Cube Cross Tee
BU	Bulkhead Union Body	CTB	Cube Tribow
BSU	Bulkhead Short Union Body		

F. Surface Finish

Identifier	Specification
Blank	10 μ in Ra
P	5.0 μ in Ra
PX	4.0 μ in Ra

G. Temperature Ratings

Components	Material	Temperature, $^{\circ}$ F($^{\circ}$ C)	Components	Material	Temperature, $^{\circ}$ F($^{\circ}$ C)
Fittings	316 Stainless Steel	1000(537)	Gaskets	316 Stainless Steel	1000 (537)
	316L Stainless Steel			Nickel	600 (315)
	316L VAR Stainless Steel			Copper	400 (204)

Micro Weld Fitting

Features

- 316L VIM/VAR Material
- Permanently Heat code marked; traceable to original mill certificate of test.
- Electropolished components permanently marked with designator on cube (P or PX)
- Critical surfaces are 100% visually inspected using magnification and lighting.

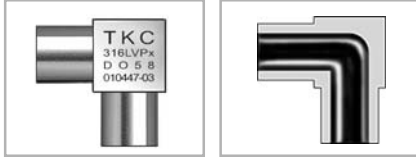

Materials

- 316L VIM/VAR Material complies with ASTM A276 and ASME SA479. Recommended tubing specifications include ASME SA213, ASTM A213, ASTM A249, ASTM A269, MIL T8504, and MIL T8506.

Specifications

- **Pressure Ratings** will be governed by the tubing selected for a particular application. Working Pressures are calculated below for tubing using maximum allowable stress levels in accordance with ASME/ANSI B31.3, at ambient temperature.

Tube O.D.	Pressure Rating		Normal Wall Thickness
	psig	bar	
1/4in.	5100	350	.035in.
3/8in.	3300	220	.035in.
1/2in.	3500	240	.049in.
6mm	6600	460	1mm

- **Dimensions** are for reference only and are subject to change.

- **Internal Surface Finishes:** Standard finish Micro Fittings have an internal Surface Roughness of 10 μ inch Ra. Electropolished Micro Fittings have an internal Surface Roughness of 5 μ inch Ra.

Designator	Surface Finish(Ra)	
	Average	Maximum
BA	10 μ in.(0.25 μ m)	15 μ in.(0.38 μ m)
P	5 μ in.(0.13 μ m)	10 μ in.(0.25 μ m)
Px	4 μ in.(0.10 μ m)	7 μ in.(0.18 μ m)

Dimensions/Ordering Information

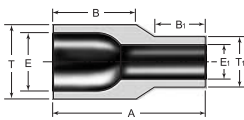

Reducing Union

T Tube OD	T ₁ Tube OD	Ordering Number	A		B		B ₁		E		E ₁		Working Pressure (SS) psig(bar)
			in.	mm	in.	mm	in.	mm	in.	mm	in.	mm	
3/8	1/4	-6T6 - MR - 4T1	0.75	19.1	0.41	10.4	0.25	6.4	0.31	7.9	0.18	4.6	3300(227)
1/2	1/4	-8T6 - MR - 4T1	0.75	19.1	0.41	10.4	0.25	6.4	0.40	10.2	0.18	4.6	3700(254)
1/2	3/8	-8T6 - MR - 6T1	0.75	19.1	0.41	10.4	0.25	6.4	0.40	10.2	0.31	7.9	3300(227)

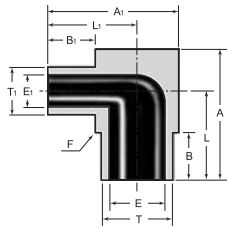

Reducing Elbow

T Tube OD	T ₁ Tube OD	Ordering Number	A		A ₁		B		B ₁		E		E ₁		F Body Cube	L		L ₁	Working Pressure (SS) psig(bar)	
			in.	mm	in.	mm	in.	mm	in.	mm	in.	mm	in.	mm		in.	mm			
3/8	1/4	-6T1 - ME - 4T1	0.69	17.5	0.69	17.5	0.25	6.4	0.25	6.4	0.31	7.9	0.18	4.6	7/16	0.47	11.9	0.47	11.9	3300(227)
1/2	1/4	-8T1 - ME - 4T1	0.81	20.6	0.81	20.6	0.25	6.4	0.25	6.4	0.40	10.2	0.18	4.6	9/16	0.53	13.5	0.53	13.5	3700(254)
1/2	3/8	-8T1 - ME - 6T1	0.81	20.6	0.81	20.6	0.25	6.4	0.25	6.4	0.40	10.2	0.31	7.9	9/16	0.53	13.5	0.53	13.5	3300(227)

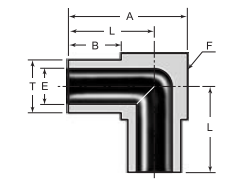

90° Union Elbow

T Tube OD	Ordering Number	A		B		E		F Body Cube	L		Working Pressure (SS) psig(bar)
		in.	mm	in.	mm	in.	mm		in.	mm	
1/8	-2T1 - ME	0.56	14.2	0.25	6.4	0.07	1.78	5/16	0.41	10.4	8500(585)
1/4	-4T1 - ME	0.56	14.2	0.25	6.4	0.18	4.6	5/16	0.41	10.4	5100(351)
3/8	-6T1 - ME	0.69	17.5	0.25	6.4	0.31	7.9	7/16	0.47	11.9	3300(227)
1/2	-8T1 - ME	0.81	20.6	0.25	6.4	0.40	10.2	9/16	0.53	13.5	3700(254)
6mm	-6MT1 - ME	0.56	14.2	0.25	6.4	0.16	4.0	5/16	0.41	10.4	420(5095)

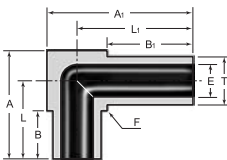

Extended Leg 90° Union Elbow

T Tube OD	Ordering Number	A		A ₁		B		B ₁		E		F Body Cube	L		L ₁	Working Pressure (SS) psig(bar)	
		in.	mm	in.	mm	in.	mm	in.	mm	in.	mm						
1/4	-4T1-ME-4T7	0.56	14.2	0.76	19.3	0.25	6.4	0.45	11.4	0.18	4.6	5/16	0.41	10.4	0.61	15.5	5100(351)
1/4	-4T1-ME-4T8	0.56	14.2	0.81	20.6	0.25	6.4	0.50	12.7	0.18	4.6	5/16	0.41	10.4	0.66	16.8	5100(351)
1/4	-4T7-ME	0.76	19.3	0.76	19.3	0.45	11.4	0.45	11.4	0.18	4.6	5/16	0.61	15.5	0.61	15.5	5100(351)
1/4	-4T8-ME	0.81	20.6	0.81	20.6	0.50	12.7	0.50	12.7	0.18	4.6	5/16	0.66	16.8	0.66	16.8	5100(351)

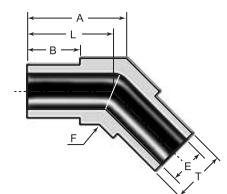

45° Union Elbow

T Tube OD	Ordering Number	A		B		E		F Body Cube	L		Working Pressure (SS) psig(bar)
		in.	mm	in.	mm	in.	mm		in.	mm	
1/4	- 4T1 - MHE	0.47	11.9	0.25	6.4	0.18	4.6	5/16	0.41	10.4	5100(351)
3/8	- 6T1 - MHE	0.56	14.2	0.25	6.4	0.31	7.9	7/16	0.47	11.9	3300(227)
1/2	- 8T1 - MHE	0.64	16.2	0.25	6.4	0.40	10.2	9/16	0.53	13.5	3700(254)

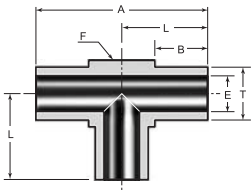

Union Tee

T Tube OD	Ordering Number	A		B		E		F Body Cube	L		Working Pressure (SS) psig(bar)
		in.	mm	in.	mm	in.	mm		in.	mm	
1/8	-2T1 - MT	0.82	20.8	0.25	6.4	0.07	1.78	5/16	0.41	10.4	8500(585)
1/4	-4T1 - MT	0.82	20.8	0.25	6.4	0.18	4.6	5/16	0.41	10.4	5100(351)
3/8	-6T1 - MT	0.94	23.9	0.25	6.4	0.31	7.9	7/16	0.47	11.9	3300(227)
1/2	-8T1 - MT	1.06	26.9	0.25	6.4	0.40	10.2	9/16	0.53	13.5	3700(254)
6mm	-6MT1 - MT	0.82	20.8	0.25	6.4	0.16	4.0	5/16	0.41	10.4	420(6095)

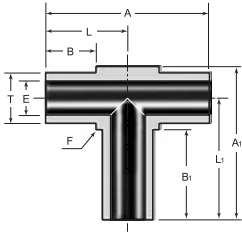

Extended Branch Leg Union Tee

T Tube OD	Ordering Number	A		A ₁		B		B ₁		E		F Body Cube	L		L ₁		Working Pressure (SS) psig(bar)
		in.	mm	in.	mm	in.	mm	in.	mm	in.	mm		in.	mm	in.	mm	
1/4	-4T1-MT-4T1-4T7	0.82	20.8	0.76	19.3	0.25	6.4	0.45	11.4	0.18	4.6	5/16	0.41	10.4	0.61	15.5	5100(351)

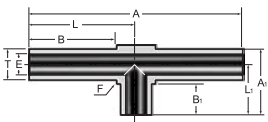

Extended Run Leg Union Tee

T Tube OD	Ordering Number	A		A ₁		B		B ₁		E		F Body Cube	L		L ₁		Working Pressure (SS) psig(bar)
		in.	mm	in.	mm	in.	mm	in.	mm	in.	mm		in.	mm	in.	mm	
1/4	-4T1-MT-4T7-4T7	1.96	49.8	0.56	14.2	0.83	21.1	0.25	6.4	0.18	4.6	5/16	0.98	24.9	0.41	10.4	5100(351)

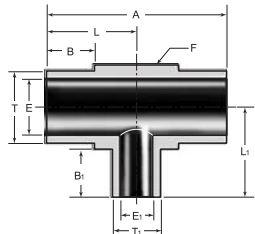

Reducing Tee

T Tube OD	T ₁ Tube OD	Ordering Number	A		B		B ₁		E		E ₁		F Body Cube	L		L ₁		Working Pressure (SS) psig(bar)
			in.	mm	in.	mm	in.	mm	in.	mm	in.	mm		in.	mm	in.	mm	
3/8	1/4	-6T1-MT-6T1-4T1	0.94	23.9	0.25	6.4	0.25	6.4	0.31	7.9	0.18	4.6	7/16	0.47	11.9	0.47	11.9	3300(227)
1/2	1/4	-8T1-MT-8T1-4T1	1.06	26.9	0.25	6.4	0.25	6.4	0.40	10.2	0.18	4.6	9/16	0.53	13.5	0.53	13.5	3700(254)
1/2	3/8	-8T1-MT-8T1-6T1	1.06	26.9	0.25	6.4	0.25	6.4	0.40	10.2	0.31	7.9	9/16	0.53	13.5	0.53	13.5	3300(227)

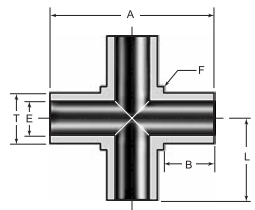

Union Cross

T Tube OD	Ordering Number	A		B		E		F Body Cube	L		Working Pressure (SS) psig(bar)
		in.	mm	in.	mm	in.	mm		in.	mm	
1/8	-2T1 - MCT	0.82	20.8	0.25	6.4	0.07	1.78	5/16	0.41	10.4	8500(585)
1/4	-4T1 - MCT	0.82	20.8	0.25	6.4	0.18	4.6	5/16	0.41	10.4	5100(351)
3/8	-6T1 - MCT	0.94	23.9	0.25	6.4	0.31	7.9	7/16	0.47	11.9	3300(227)
1/2	-8T1 - MCT	1.06	26.9	0.25	6.4	0.40	10.2	9/16	0.53	13.5	3700(254)
6mm	-6MT1 - MCT	0.81	20.6	0.25	6.4	0.16	4.0	5/16	0.41	10.4	420(6095)

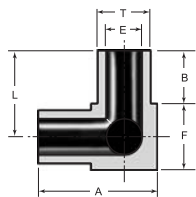

Tribow

T Tube OD	Ordering Number	A		B		E		F Body Cube	L		Working Pressure (SS) psig(bar)
		in.	mm	in.	mm	in.	mm		in.	mm	
1/4	-4T1 - MTB	0.56	14.2	0.25	6.4	0.18	4.6	5/16	0.41	10.4	5100(351)
3/8	-6T1 - MTB	0.69	17.5	0.25	6.4	0.31	7.9	7/16	0.47	11.9	3300(227)
1/2	-8T1 - MTB	0.81	20.6	0.25	6.4	0.40	10.2	9/16	0.53	13.5	3700(254)

Tube Butt Weld Fitting

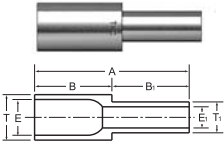

Reducing Union

T Tube OD	T ₁ Tube OD	Ordering Number	A		B		B ₁		E		E ₁		Working Pressure (SS) psig(bar)
			in.	mm	in.	mm	in.	mm	in.	mm	in.	mm	
3/8	1/4	<input type="checkbox"/> -6T3 - R - 4T3	1.50	38.1	.75	19.1	.75	19.1	.30	7.7	.18	4.6	3300(227)
1/2	1/4	<input type="checkbox"/> -8T3 - R - 4T3	1.50	38.1	.75	19.1	.75	19.1	.40	10.2	.18	4.6	3700(254)
1/2	3/8	<input type="checkbox"/> -8T3 - R - 6T3	1.50	38.1	.75	19.1	.75	19.1	.40	10.2	.30	7.7	3300(227)

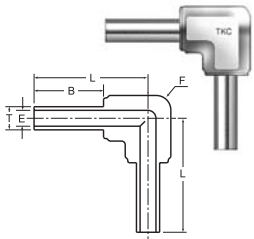

Union Elbow

T Tube OD	Ordering Number	B		E		F Wrench Flat	L		Working Pressure (SS) psig(bar)
		in.	mm	in.	mm		in.	mm	
1/4	<input type="checkbox"/> - 4T3 - E	.75	19.1	.18	4.6	7/16	1.23	31.2	5100(351)
3/8	<input type="checkbox"/> - 6T3 - E	.75	19.1	.30	7.7	7/16	1.20	30.5	3300(227)
1/2	<input type="checkbox"/> - 8T3 - E	.75	19.1	.40	10.2	11/16	1.34	34.0	3700(254)

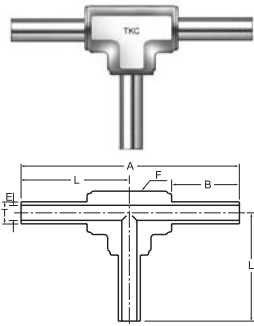

Union Tee

T Tube OD	Ordering Number	A		B		E		F Wrench Flat	L		Working Pressure (SS) psig(bar)
		in.	mm	in.	mm	in.	mm		in.	mm	
1/4	<input type="checkbox"/> - 4T3 - T	2.45	62.2	.75	19.1	.18	4.6	7/16	1.23	31.2	5100(351)
3/8	<input type="checkbox"/> - 6T3 - T	2.39	60.7	.75	19.1	.30	7.7	7/16	1.20	30.5	3300(227)
1/2	<input type="checkbox"/> - 8T3 - T	2.67	67.8	.75	19.1	.40	10.2	11/16	1.34	34.0	3700(254)

Automatic Tube Weld Fitting

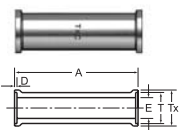

Union

T Tube OD	Ordering Number	A		D		E		Tx		Working Pressure (SS) psig(bar)
		in.	mm	in.	mm	in.	mm	in.	mm	
1/4	<input type="checkbox"/> - 4A - TA	1.00	25.4	0.02	0.5	.18	4.6	.29	7.4	5100(351)
3/8	<input type="checkbox"/> - 6A - TA	1.00	25.4	0.03	0.8	.30	7.6	.41	10.4	3300(227)
1/2	<input type="checkbox"/> - 8A - TA	1.00	25.4	0.04	1.0	.40	10.2	.55	14.0	3700(254)
3/4	<input type="checkbox"/> -12A - TA	1.00	25.4	0.04	1.0	.65	16.5	.80	20.3	2400(165)
1	<input type="checkbox"/> -16A - TA	1.25	31.8	0.04	1.0	.87	22.1	1.06	26.9	2400(165)

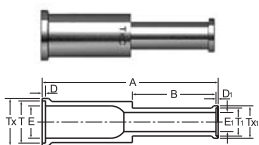

Reducing Union

T Tube OD	T ₁ Tube OD	Ordering Number	A		B		D		D ₁		E		E ₁		Tx		Tx ₁	Working Pressure (SS) psig(bar)	
			in.	mm	in.	mm	in.	mm	in.	mm	in.	mm	in.	mm	in.	mm			
3/8	1/4	<input type="checkbox"/> -6A3 - R - 4A3	1.58	40.1	.75	19.1	.03	0.8	.02	0.5	.30	7.6	.18	4.6	.41	10.4	.29	7.4	3300(227)
1/2	1/4	<input type="checkbox"/> -8A3 - R - 4A3	1.58	40.1	.75	19.1	.04	1.0	.02	0.5	.40	10.2	.18	4.6	.55	14.0	.29	7.4	3700(254)
1/2	3/8	<input type="checkbox"/> -8A3 - R - 6A3	1.59	40.4	.75	19.1	.04	1.0	.03	0.8	.40	10.2	.30	7.6	.55	14.0	.41	10.4	3300(227)

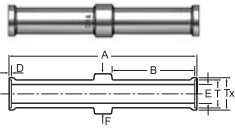

Locator Union

T Tube OD	Ordering Number	A		B		D		E		F		Tx		Working Pressure (SS) psig(bar)
		in.	mm	in.	mm	in.	mm	in.	mm	in.	mm	in.	mm	
1/4	□ - 4A3 - LA	1.69	42.9	.75	19.1	.02	0.5	.18	4.6	.36	9.1	.29	7.4	5100(351)
3/8	□ - 6A3 - LA	1.71	43.4	.75	19.1	.03	0.8	.30	7.6	.42	10.7	.41	10.4	3300(227)
1/2	□ - 8A3 - LA	1.73	43.9	.75	19.1	.04	1.0	.40	10.2	.60	15.2	.55	14.0	3700(254)

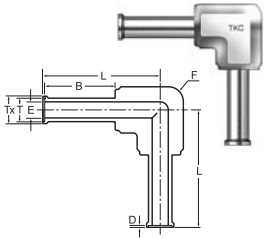

90° Union Elbow

T Tube OD	Ordering Number	B		D		E		F Wrench Flat	L		Tx		Working Pressure (SS) psig(bar)
		in.	mm	in.	mm	in.	mm		in.	mm	in.	mm	
1/4	□ - 4A3 - E	.75	19.1	.02	0.5	.18	4.6	7/16	1.25	31.8	.29	7.4	5100(351)
3/8	□ - 6A3 - E	.75	19.1	.03	0.8	.30	7.6	7/16	1.23	31.2	.41	10.4	3300(227)
1/2	□ - 8A3 - E	.75	19.1	.04	1.0	.40	10.2	11/16	1.38	35.1	.55	14.0	3700(254)
3/4	□ - 12A3 - E	.75	19.1	.04	1.0	.65	16.5	15/16	1.50	38.1	.80	20.3	2400(165)
1	□ - 16A3 - E	.96	24.4	.04	1.0	.87	22.1	1-1/4	1.89	48.0	1.06	26.9	2400(165)

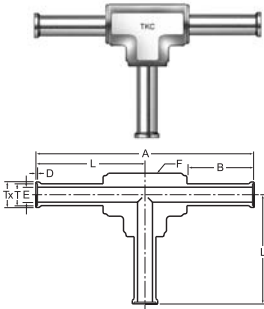

Union Tee

T Tube OD	Ordering Number	A		B		D		E		F Wrench Flat	L		Tx		Working Pressure (SS) psig(bar)
		in.	mm	in.	mm	in.	mm	in.	mm		in.	mm	in.	mm	
1/4	□ - 4A3 - T	2.50	63.5	.75	19.1	.02	0.5	.18	4.6	7/16	1.25	31.8	.29	7.4	5100(351)
3/8	□ - 6A3 - T	2.46	62.5	.75	19.1	.03	0.8	.30	7.6	7/16	1.23	31.2	.41	10.4	3300(227)
1/2	□ - 8A3 - T	2.76	70.1	.75	19.1	.04	1.0	.40	10.2	11/16	1.38	35.1	.55	14.0	3700(254)
3/4	□ - 12A3 - T	3.00	76.2	.75	19.1	.04	1.0	.65	16.5	15/16	1.50	38.1	.80	20.3	2400(165)
1	□ - 16A3 - T	3.78	96.0	.96	24.4	.04	1.0	.87	22.1	1-1/4	1.89	48.0	1.06	26.9	2400(165)

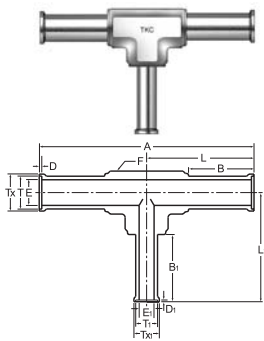

Reducing Union Tee

T Tube OD	T ₁ Tube OD	Ordering Number	A		B		B ₁		D		D ₁		E		E ₁		F Wrench Flat	L		L ₁		Tx		Tx ₁		Working Pressure (SS) psig(bar)
			in.	mm	in.	mm	in.	mm	in.	mm	in.	mm	in.	mm	in.	mm		in.	mm	in.	mm	in.	mm	in.	mm	
3/8	1/4	□ - 6A3-T- 6A3-4A3	2.46	62.5	.75	19.1	.75	19.1	.03	0.8	.02	0.5	.30	7.6	.18	4.6	7/16	1.23	31.2	1.25	31.8	.41	.41	.29	7.4	3300(227)
1/2	1/4	□ - 8A3-T- 8A3-4A3	2.76	70.1	.75	19.1	.75	19.1	.04	1.0	.02	0.8	.40	10.2	.18	4.6	11/16	1.38	35.1	1.38	35.1	.55	.55	.29	7.4	3700(254)
1/2	3/8	□ - 8A3-T- 8A3-6A3	2.76	70.1	.75	19.1	.75	19.1	.04	1.0	.03	0.8	.40	10.2	.30	7.6	11/16	1.38	35.1	1.38	35.1	.55	.55	.41	10.4	3300(227)
3/4	3/8	□ - 12A3-T-12A3-6A3	3.00	76.2	.75	19.1	.75	19.1	.04	1.0	.03	1.0	.65	16.5	.30	7.6	15/16	1.50	38.1	1.50	38.1	.80	.80	.41	10.4	2400(165)
3/4	1/2	□ - 12A3-T-12A3-8A3	3.00	76.2	.75	19.1	.75	19.1	.04	1.0	.04	1.0	.65	16.5	.40	10.2	15/16	1.50	38.1	1.50	38.1	.80	.80	.55	14.0	2400(165)

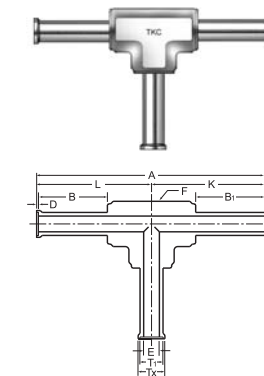

Manifold Tee

T Tube OD	T ₁ Tube OD	Ordering Number	A		B		B ₁		D		E		F Wrench Flat	K		L		Tx		Working Pressure (SS) psig(bar)
			in.	mm	in.	mm	in.	mm	in.	mm	in.	mm		in.	mm	in.	mm	in.	mm	
1/4	1/4	□ - 4A3-T-4T3-4A3	2.48	63.0	.75	19.1	.75	19.1	.02	0.5	.18	4.6	7/16	1.23	31.2	1.25	31.8	.29	7.4	5100(351)
3/8	3/8	□ - 6A3-T-6T3-6A3	2.46	62.5	.75	19.1	.75	19.1	.03	0.8	.30	7.6	7/16	1.20	30.5	1.23	31.2	.41	10.4	3300(227)
1/2	1/2	□ - 8A3-T-8T3-8A3	2.72	69.1	.75	19.1	.75	19.1	.04	1.0	.40	10.2	11/16	1.34	34.0	1.38	35.1	.55	14.0	3700(254)

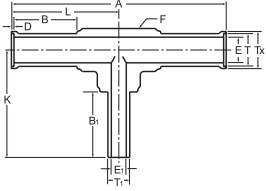
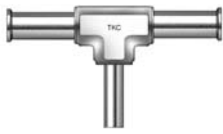

Reducing Tee

T Tube OD	T ₁ Tube OD	Ordering Number	A		B		B ₁		D		E		E ₁		F Wrench Flat	K		L		Tx		Working Pressure (SS) psig(bar)
			in.	mm	in.	mm	in.	mm	in.	mm	in.	mm	in.	mm		in.	mm	in.	mm	in.	mm	
3/8	1/4	-6A3-T-6A3-4T3	2.46	62.5	.75	19.1	.75	19.1	.03	0.8	.30	7.6	.18	4.6	7/16	1.23	31.2	1.23	31.2	.41	10.4	3300(227)
1/2	1/4	-8A3-T-8A3-4T3	2.76	70.1	.75	19.1	.75	19.1	.04	1.0	.40	10.2	.18	4.6	7/16	1.36	34.5	1.38	35.1	.55	14.0	3700(254)
1/2	3/8	-8A3-T-8A3-6T3	2.76	70.1	.75	19.1	.75	19.1	.04	1.0	.40	10.2	.30	7.6	11/16	1.35	34.3	1.38	35.1	.55	14.0	3300(227)

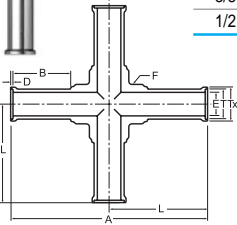
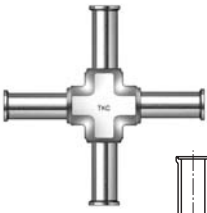

Union Cross

T Tube OD	Ordering Number	A		B		D		E		F Wrench Flat	L		Tx		Working Pressure (SS) psig(bar)
		in.	mm	in.	mm	in.	mm	in.	mm		in.	mm	in.	mm	
1/4	- 4A3 - CT	2.50	63.5	.75	19.1	.02	0.5	.18	4.6	7/16	1.25	31.8	.29	7.4	5100(351)
3/8	- 6A3 - CT	2.46	62.5	.75	19.1	.03	0.8	.30	7.6	7/16	1.23	31.2	.41	10.4	3300(227)
1/2	- 8A3 - CT	2.70	68.6	.75	19.1	.04	1.0	.40	10.2	5/8	1.35	34.3	.55	14.0	3700(254)

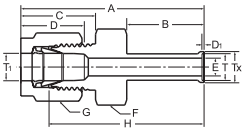

Superlok To ATW Connector

T Tube OD	T ₁ Tube OD	Ordering Number	A		B		C		D		D ₁		E		F Body Flat	G Nut Hex	H		Tx		Working Pressure (SS) psig(bar)
			in.	mm	in.	mm	in.	mm	in.	mm	in.	mm	in.	mm			in.	mm	in.	mm	
1/4	1/4	-4A3-CB-4K	1.74	44.2	.75	19.1	.70	17.8	.60	15.2	.02	0.5	.18	4.6	1/2	9/16	1.45	36.8	.29	7.4	5100(351)
3/8	3/8	-6A3-CB-6K	1.84	46.7	.75	19.1	.76	19.3	.66	16.8	.03	0.8	.30	7.6	5/8	11/16	1.55	39.4	.41	10.4	3300(227)
1/2	1/2	-8A3-CB-8K	1.99	50.5	.75	19.1	.86	21.8	.90	22.9	.04	1.0	.40	10.2	13/16	7/8	1.59	40.4	.55	14.0	3700(254)

Automatic Socket Weld Fitting

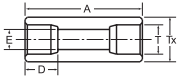

Union

T Tube OD	Ordering Number	A		D		E		Tx		Working Pressure (SS) psig(bar)
		in.	mm	in.	mm	in.	mm	in.	mm	
1/4	- 4S - TA	1.00	25.4	.28	7.1	.18	4.6	.38	9.7	6800(468)
3/8	- 6S - TA	1.00	25.4	.31	7.9	.28	7.1	.50	12.7	4900(337)
1/2	- 8S - TA	1.00	25.4	.38	9.7	.40	10.2	.62	15.7	3800(261)
3/4	- 12S - TA	1.00	25.4	.44	11.2	.62	15.7	.88	22.4	2700(186)

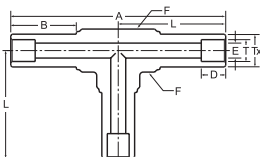

Union Tee

T Tube OD	Ordering Number	A		B		D		E		F Wrench Flat	L		Tx		Working Pressure (SS) psig(bar)
		in.	mm	in.	mm	in.	mm	in.	mm		in.	mm			
1/4	- 4S3 - T	2.46	62.5	.75	19.1	.28	7.1	.18	4.6	7/16	1.23	31.2	.38	9.7	6800(468)
3/8	- 6S3 - T	2.68	68.1	.75	19.1	.31	7.9	.28	7.1	7/16	1.34	34.0	.50	12.7	4900(337)
1/2	- 8S3 - T	2.68	68.1	.75	19.1	.38	9.7	.40	10.2	11/16	1.34	34.0	.62	15.7	3800(261)
3/4	- 12S3 - T	2.94	74.7	.75	19.1	.44	11.2	.62	15.7	15/16	1.47	37.3	.88	22.4	2700(186)

Face Seal Fitting

- **High-Purity Nickel and Hastelloy C-22** glands for extremely corrosive applications.
- **Non-Rotational Female Nut** to prevent transmission of torque during make-up and therefore minimize twist of componentry which causes stress concentration.
- **Anti-Galling Female Nut** to ensure consistent make-up without plating or lubrication.



Materials

Glands, Bodies and Nuts

Material	Ordering Number Designator	Applicable Specification
316 Stainless Steel	SP	bar stock : ASME SA479, ASTM A276 forgings : ASEM SA182, ASTM A314
316L Stainless Steel	SL	bar stock : ASME SA479, ASTM A276 forgings : ASTM A182
316L Stainless Steel Single Melt	SM	bar stock : ASME SA479, ASTM A276 forgings : ASTM A182
316L VAR(Vacuum Arc Remelt) Stainless Steel Double Melt	DM	bar stock : ASME SA479, ASTM A276 forgings : ASTM A182

Temperature Ratings

Fittings:
Stainless Steel 316, 316L, SM, DM
1000 °F(537°C)

Gaskets:
High-Purity Nickel 600 °F(315°C)
Stainless Steel 1000 °F(537°C)

- **Dimensions** are for reference only and are subject to change

- **Plating** female nuts are silver plated with an enhanced plating process. Avoid aggressive chemical processes used for cleaning, electropolishing and passivation that will remove plating. Removal or damage to plating will cause threads to gall, damaging fitting components and preventing a proper seal.

- **Testing** products are rated to a Helium leak rate of 1×10^{-9} atm cc/sec.

- **Internal Surface Finishes:** components are available with controlled surface finishes and electropolished internal surfaces.

- **Cleaning and Packaging:** Ultra-High Purity cleaning and packaging in a Class 100 Clean Room environment validated per Federal Standard 209E, is standard for all electropolished components.

Some Configuration

Gaskets

Material	Ordering Number Designator	Applicable Specification
Nickel	NI	ASTM B162
316L Stainless Steel	SL	ASTM A167

Specifications

- **Pressure Ratings** are based upon tests conducted on assemblies. All ratings comply with calculations per ANSI Code for Pressure Piping B31.3.

- **Working Pressures** are rated at ambient temperature and are based on a 4 to 1 design factor. To determine pressure ratings in accordance with ANSI B31.1 multiply **Working Pressures** by 0.94.

Designator	Surface Finish(Ra)	
	Average	Maximum
BA	10 _μ in.(0.25 _μ m)	15 _μ in.(0.38 _μ m)
P	5 _μ in.(0.13 _μ m)	10 _μ in.(0.25 _μ m)
Px	4 _μ in.(0.10 _μ m)	7 _μ in.(0.18 _μ m)

Typical Face Seal Fittings

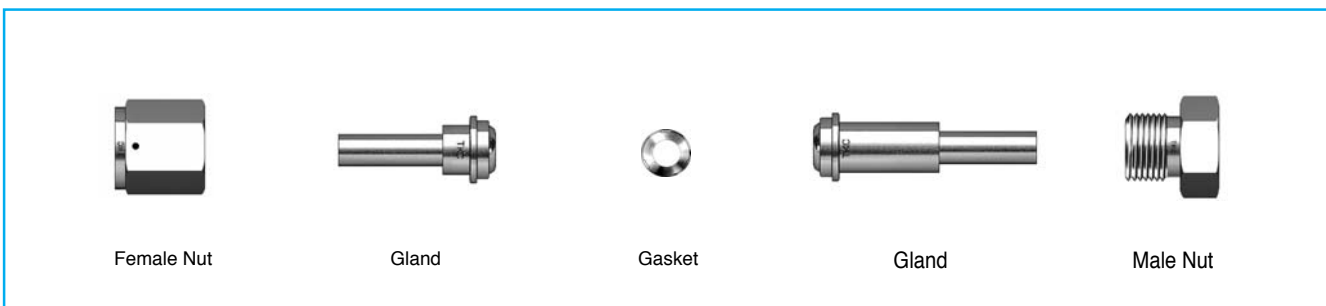

Glands

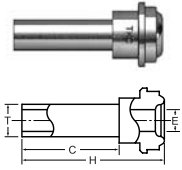

Tube Butt Weld Short Glands

T Tube OD	Ordering Number	C		E		H		Working Pressure (SS) psig(bar)	Normal Wall Thickness
		in.	mm	in.	mm	in.	mm		
Fractional									
1/8	□-2V-SG-2T1	0.75	19.1	0.06	1.5	1.08	27.4	8500(585)	0.028in.
1/4	□-4V-SG-4T1	0.25	6.4	0.18	4.6	0.60	15.2	5100(351)	0.035in.
1/4	□-4V-SG-4T2	0.38	9.6	0.18	4.6	0.72	18.3	5100(351)	0.035in.
1/4	□-4V-SG-4T3	0.75	19.1	0.18	4.6	1.10	27.9	5100(351)	0.035in.
1/4	□-8V-SG-4T3	0.75	19.1	0.18	4.6	1.12	28.4	4300(296)	0.035in.
3/8	□-8V-SG-6T1	0.25	6.4	0.31	7.9	0.62	15.7	3300(227)	0.035in.
3/8	□-8V-SG-6T3	0.75	19.1	0.31	7.9	1.12	28.4	3300(227)	0.035in.
1/2	□-8V-SG-8T1	0.25	6.4	0.40	10.2	0.62	15.7	3500(241)	0.049in.
1/2	□-8V-SG-8T2	0.38	9.6	0.40	10.2	0.74	18.8	3500(241)	0.049in.
1/2	□-8V-SG-8T3	0.75	19.1	0.40	10.2	1.12	28.4	3500(241)	0.049in.
Metric									
6mm	□-4V-SG-6MT3	0.75	19.1	0.16	4.0	1.16	29.5	468(6800)	1.0mm
8mm	□-4V-SG-8MT3	0.75	19.1	0.24	6.0	1.16	29.5	337(4900)	1.0mm
10mm	□-8V-SG-10MT3	0.75	19.1	0.31	8.0	1.16	29.5	241(3500)	1.0mm
12mm	□-8V-SG-12MT3	0.75	19.1	0.39	10.0	1.16	29.5	213(3100)	1.0mm
18mm	□-12V-SG-18MT3	0.75	19.1	0.59	15.0	1.22	31.0	206(3000)	1.5mm

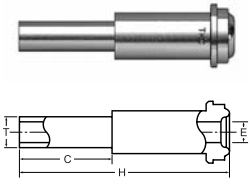

Tube Butt Weld Long Glands

T Tube OD	Ordering Number	C		E		H		Working Pressure (SS) psig(bar)	Normal Wall Thickness
		in.	mm	in.	mm	in.	mm		
Fractional									
1/8	□-2V-LG-2T1	0.75	19.1	0.06	1.5	1.42	36.1	8500(585)	0.028in.
1/4	□-4V-LG-4T1	0.25	6.4	0.18	4.6	1.20	30.5	5100(351)	0.035in.
1/4	□-4V-LG-4T1-X1	0.36	9.1	0.18	4.6	1.31	33.3	5100(351)	0.035in.
1/4	□-4V-LG-4T2	0.38	9.6	0.18	4.6	1.32	33.5	5100(351)	0.035in.
1/4	□-4V-LG-4T3	0.75	19.1	0.18	4.6	1.70	43.2	5100(351)	0.035in.
1/4	□-4V-LG-4T3	0.75	19.1	0.18	4.6	1.80	45.7	4300(296)	0.035in.
3/8	□-8V-LG-6T1	0.25	6.4	0.31	7.9	1.29	32.8	3300(227)	0.035in.
3/8	□-8V-LG-6T3	0.75	19.1	0.31	7.9	1.79	45.5	3300(227)	0.035in.
1/2	□-8V-LG-8T1	0.25	6.4	0.40	10.2	1.29	32.8	3500(241)	0.049in.
1/2	□-8V-LG-8T2	0.38	9.6	0.40	10.2	1.41	35.8	3500(241)	0.049in.
1/2	□-8V-LG-8T3	0.75	19.1	0.40	10.2	1.79	45.5	3500(241)	0.049in.
3/4	□-12V-LG-12T3	0.75	19.1	0.65	16.5	2.03	51.6	2400(165)	0.049in.
1	□-16V-LG-16T3	0.75	19.1	0.87	22.1	2.32	58.9	2400(165)	0.065in.
Metric									
6mm	□-4V-LG-6MT3	0.75	19.1	0.16	4.0	1.70	43.2	468(6800)	1.0mm
8mm	□-4V-LG-8MT3	0.75	19.1	0.24	6.0	1.70	43.2	337(4900)	1.0mm
10mm	□-8V-LG-10MT3	0.75	19.1	0.31	8.0	1.79	45.5	241(3500)	1.0mm
12mm	□-8V-LG-12MT3	0.75	19.1	0.39	10.0	1.79	45.5	213(3100)	1.0mm
18mm	□-12V-LG-18MT3	0.75	19.1	0.59	15.0	2.03	51.6	206(3000)	1.5mm

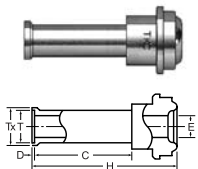

Automatic Tube Butt Weld Short Glands

T Tube OD	Ordering Number	C		D		E		H		Tx		Working Pressure (SS) psig(bar)	Normal Wall Thickness
		in.	mm	in.	mm	in.	mm	in.	mm	in.	mm		
Fractional													
1/4	□-4V-SG-4A3	0.75	19.1	0.02	0.5	0.18	4.6	1.12	28.4	0.29	7.4	5100(351)	0.035in.
3/8	□-8V-SG-6A3	0.75	19.1	0.03	0.8	0.31	7.9	1.15	29.2	0.41	10.4	3300(227)	0.035in.
1/2	□-8V-SG-8A3	0.75	19.1	0.04	1.0	0.40	10.2	1.16	29.5	0.55	14.0	3500(241)	0.049in.
Metric													
6mm	□-4V-SG-4MA3	0.75	19.1	0.02	0.5	0.16	4.0	1.18	30.0	0.27	6.8	468(6800)	1.0mm
8mm	□-4V-SG-8MA3	0.75	19.1	0.03	0.8	0.24	6.0	1.19	30.2	0.35	8.9	337(4900)	1.0mm
10mm	□-8V-SG-10MA3	0.75	19.1	0.03	0.8	0.31	8.0	1.22	31.0	0.43	10.9	241(3500)	1.0mm
12mm	□-8V-SG-12MA3	0.75	19.1	0.04	1.0	0.39	10.0	1.20	30.5	0.52	13.2	213(3100)	1.0mm

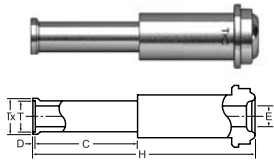

Automatic Tube Butt Weld Long Glands

T Tube OD	Ordering Number	C		D		E		H		Tx		Working Pressure (SS) psig(bar)	Normal Wall Thickness
		in.	mm	in.	mm	in.	mm	in.	mm	in.	mm		
Fractional													
1/4	□ - 4V - LG - 4A3	0.75	19.1	0.02	0.5	0.18	4.6	1.72	43.7	0.29	7.4	5100(351)	0.035in.
1/4	□ - 8V - LG - 4A3	0.75	19.1	0.02	0.5	0.18	4.6	1.82	46.2	0.29	7.4	3500(241)	0.035in.
3/8	□ - 8V - LG - 6A3	0.75	19.1	0.03	0.8	0.31	7.9	1.82	46.2	0.41	10.4	3300(227)	0.035in.
1/2	□ - 8V - LG - 8A3	0.75	19.1	0.04	1.0	0.40	10.2	1.83	46.5	0.55	14.0	3500(241)	0.049in.
3/4	□ - 12V - LG - 12A3	0.75	19.1	0.04	1.0	0.65	16.5	2.07	52.6	0.80	20.3	2400(165)	0.049in.
1	□ - 16V - LG - 16A4	0.96	24.4	0.04	1.0	0.87	22.1	2.57	65.3	1.06	26.9	2400(165)	0.065in.
Metric													
6mm	□ - 4V - LG - 6MA3	0.75	19.1	0.02	0.5	0.16	4.0	1.72	43.7	0.27	6.8	468(6800)	1.0mm
12mm	□ - 8V - LG - 12MA3	0.75	19.1	0.04	1.0	0.39	10.0	1.83	46.5	0.52	13.2	213(3100)	1.0mm
18mm	□ - 12V - LG - 18MA3	0.75	19.1	0.04	1.0	0.59	15.0	2.07	52.6	0.76	19.3	206(3000)	1.5mm

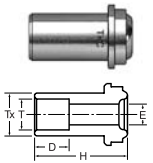

Socket Weld Short Glands

T Tube OD	Ordering Number	D		E		H		Tx		Working Pressure (SS) psig(bar)
		in.	mm	in.	mm	in.	mm	in.	mm	
Fractional										
1/4	□ - 4V - SG - 4S - S	0.28	7.1	0.18	4.6	0.50	12.7	0.35	8.9	5500(378)
1/4	□ - 4V - SG - 4S - S - X10	0.28	7.1	0.18	4.6	0.75	19.1	0.35	8.9	5500(378)

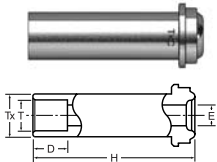

Socket Weld Long Glands

T Tube OD	Ordering Number	D		E		H		Tx		Working Pressure (SS) psig(bar)
		in.	mm	in.	mm	in.	mm	in.	mm	
Fractional										
1/8	□ - 2V - LG - 2S	0.10	2.5	0.09	2.3	0.70	17.8	0.20	5.1	7100(489)
1/4	□ - 4V - LG - 4S	0.28	7.1	0.18	4.6	1.31	33.3	0.35	8.9	5500(378)
3/8	□ - 8V - LG - 6S	0.31	7.9	0.28	7.1	1.50	38.1	0.60	15.2	4300(291)
1/2	□ - 8V - LG - 8S	0.38	9.6	0.40	10.2	1.50	38.1	0.60	15.2	3000(206)
3/4	□ - 12V - LG - 12S	0.44	11.2	0.62	15.7	2.00	50.8	0.88	22.4	2800(192)
1	□ - 16V - LG - 16S	0.62	15.7	0.87	22.1	2.22	56.4	1.19	30.2	3000(206)

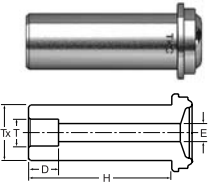

Reducing Socket Weld Long Glands

T Tube OD	Ordering Number	D		E		H		Tx		Working Pressure (SS) psig(bar)
		in.	mm	in.	mm	in.	mm	in.	mm	
Fractional										
1/8	□ - 4V - LG - 2S	0.10	2.5	0.09	2.4	1.31	33.3	0.35	8.9	8000(551)
1/4	□ - 8V - LG - 4S	0.28	7.1	0.18	4.6	1.50	38.1	0.60	15.2	3500(241)

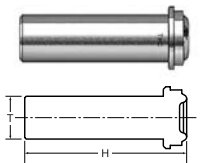

Blind Glands

T Tube OD	Ordering Number	H		T Tube OD	Ordering Number	H	
		in.	mm			in.	mm
Fractional							
1/8	□ - 2V - BG	0.70	17.8	3/4	□ - 12V - BG	2.00	50.8
1/4	□ - 4V - BG	1.31	33.3	1	□ - 16V - BG	2.22	56.4
1/2	□ - 8V - BG	1.50	38.1				

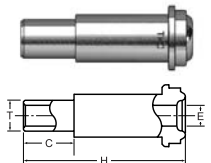

Male Weld Long Glands

T Tube OD	Ordering Number	C		E		H		Working Pressure (SS) psig(bar)
		in.	mm	in.	mm	in.	mm	
Fractional								
1/8	□ - 2V - LG - 2TM6	0.28	7.1	0.06	1.5	0.70	17.8	11200(771)
1/8	□ - 4V - LG - 2TM6	0.28	7.1	0.06	1.5	1.31	33.3	10000(689)
1/4	□ - 4V - LG - 4TM6	0.41	10.4	0.12	3.0	1.31	33.3	4300(296)
1/4	□ - 8V - LG - 4TM6	0.41	10.4	0.12	3.0	1.50	38.1	4300(296)
3/8	□ - 8V - LG - 6TM6	0.41	10.4	0.28	7.1	1.50	38.1	4300(296)
1/2	□ - 8V - LG - 8TM8	0.50	12.7	0.40	10.2	1.50	38.1	3500(241)
3/4	□ - 12V - LG - 12TM9	0.62	15.7	0.53	13.5	2.00	50.8	3700(254)
1	□ - 16V - LG - 16TM10	0.81	20.6	0.75	19.1	2.22	56.4	3000(206)

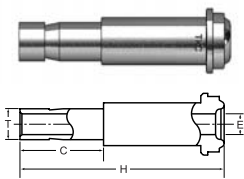

Tube Adapter Glands

T Tube OD	Ordering Number	C		E		H		Working Pressure (SS) psig(bar)
		in.	mm	in.	mm	in.	mm	
Fractional								
1/4	<input type="checkbox"/> -4V - LG - 4KM	0.64	16.2	0.17	4.3	1.62	41.0	10000(689)
3/8	<input type="checkbox"/> -8V - LG - 6KM	0.70	17.8	0.27	6.8	1.81	46.0	4300(296)
1/2	<input type="checkbox"/> -8V - LG - 8KM	0.96	24.4	0.37	9.4	1.94	49.3	4300(296)

Note: VCR Tube Adapter Glands are to be used only in Superlok tube fittings.

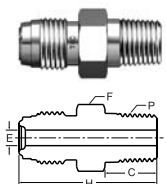

Male Connector

P Male NPT Size	Ordering Number	C		E		F Hex Flat	H		Working Pressure (SS) psig(bar)
		in.	mm	in.	mm		in.	mm	
Fractional									
1/8	<input type="checkbox"/> -2V - CB - 2N	0.38	9.6	0.09	2.3	7/16	1.07	27.2	9000(620)
1/8	<input type="checkbox"/> -4V - CB - 2N	0.38	9.6	0.18	4.6	5/8	1.31	33.3	10000(689)
1/4	<input type="checkbox"/> -4V - CB - 4N	0.56	14.2	0.18	4.6	5/8	1.49	37.8	10000(689)
3/8	<input type="checkbox"/> -8V - CB - 6N	0.56	14.2	0.38	9.6	15/16	1.65	41.9	4300(296)
1/2	<input type="checkbox"/> -8V - CB - 8N	0.75	19.1	0.40	10.2	15/16	1.84	46.7	4300(296)
3/4	<input type="checkbox"/> -12V - CB - 12N	0.75	19.1	0.62	15.7	1-5/16	2.19	55.6	3700(254)
1	<input type="checkbox"/> -16V - CB - 16N	0.94	23.9	0.87	22.1	1-5/8	2.47	62.7	3000(206)

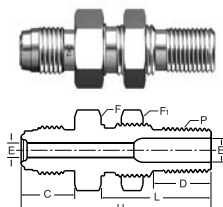

Male Bulkhead Connector

P Male NPT Size	Ordering Number	C		D		E		E ₁	F Hex Flat	F ₁ Hex Flat	H		L	Panel Hole Size	Max Panel Thick- ness	Working Pressure (SS) psig(bar)		
		in.	mm	in.	mm	in.	mm				in.	mm						
Fractional																		
1/4	<input type="checkbox"/> -4V - BC - 4N	0.62	15.7	0.56	14.2	0.18	4.6	0.28	7.1	13/16	13/16	2.21	56.1	1.24	31.5	21/32	0.38	8000(551)
1/4	<input type="checkbox"/> -8V - BC - 4N	0.75	19.1	0.56	14.2	0.40	10.2	0.28	7.1	15/16	13/16	2.34	59.4	1.24	31.5	21/32	0.38	4370(301)

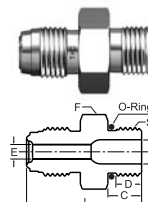

Straight Thread O-ring Seal Male Connector

S Straight Thread Size	Ordering Number	C		D		E		E ₁	F Hex Flat	H		Working Pressure (SS) psig(bar)	Uniform O-ring Size	
		in.	mm	in.	mm	in.	mm			in.	mm			
Fractional														
9/16-18	<input type="checkbox"/> -4V - CB - 4NS	0.39	9.9	0.25	6.4	0.18	4.6	0.28	7.1	3/4	1.33	33.8	4500(310)	fluorocarbon 906
7/8-14	<input type="checkbox"/> -8V - CB - 8NS	0.50	12.7	0.40	10.2	0.28	7.1	0.59	15.0	1	1.66	42.2	3500(241)	fluorocarbon 910
9/16-18	<input type="checkbox"/> -8V - CB - 4NS	0.39	9.9	n/a	n/a	0.28	7.1	0.28	7.1	15/16	1.48	37.6	3500(241)	fluorocarbon 906

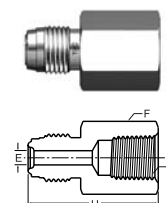

Female NPT Connector

P Female NPT Size	Ordering Number	E		F Hex Flat	H		Working Pressure (SS) psig(bar)
		in.	mm		in.	mm	
Fractional							
1/8	<input type="checkbox"/> -2V - CB - 2NF	0.09	2.3	9/16	1.19	30.2	6500(447)
1/8	<input type="checkbox"/> -4V - CB - 2NF	0.18	4.6	5/8	1.41	35.8	8000(551)
1/4	<input type="checkbox"/> -4V - CB - 4NF	0.18	4.6	3/4	1.54	39.1	6600(454)
3/8	<input type="checkbox"/> -8V - CB - 6NF	0.40	10.2	15/16	1.76	44.7	4300(296)
1/2	<input type="checkbox"/> -8V - CB - 8NF	0.40	10.2	1-1/16	1.99	50.5	4300(296)
3/4	<input type="checkbox"/> -12V - CB - 12NF	0.62	15.7	1-5/16	2.36	59.9	3700(254)
1	<input type="checkbox"/> -16V - CB - 16NF	0.87	22.1	1-5/8	2.51	63.8	3000(206)

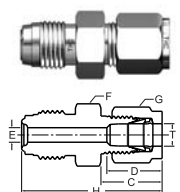

Superlok Tube Fitting Connector

T Tube OD	Ordering Number	C		D		E		F Hex Flat	G Hex Flat	H		Working Pressure (SS) psig(bar)
		in.	mm	in.	mm	in.	mm			in.	mm	
Fractional												
1/8	<input type="checkbox"/> -4V - CB - 2K	0.60	15.2	0.50	12.7	.09	2.3	5/8	7/16	1.53	38.9	10000(689)
1/4	<input type="checkbox"/> -4V - CB - 4K	0.70	17.8	0.60	15.2	.18	4.6	5/8	9/16	1.62	41.1	10000(689)
3/8	<input type="checkbox"/> -8V - CB - 6K	0.76	19.3	0.66	16.8	.28	7.1	15/16	11/16	1.84	46.7	4300(296)
1/2	<input type="checkbox"/> -8V - CB - 8K	0.86	21.8	0.90	22.9	.40	10.2	15/16	7/8	1.95	49.5	4300(296)

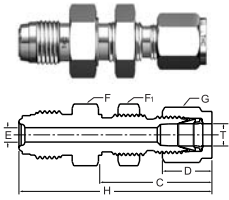

Superlok Tube Fitting Bulkhead Connector

T Tube OD	Ordering Number	C		D		E		F Hex flat	F ₁ Hex flat	G Hex flat	H		Panel Hole Size	Max Panel Thick- ness	Working Pressure (SS) psig(bar)
		in.	mm	in.	mm	in.	mm				in.	mm			
Fractional															
1/4	-4V - BC - 4K	1.32	33.5	0.60	15.2	0.18	4.6	5/8	5/8	9/16	2.25	57.2	15/32	0.40	10000(689)
1/4	-4V - BSC - 4K	1.05	26.7	0.60	15.2	0.18	4.6	5/8	5/8	9/16	1.88	47.8	15/32	0.13	10000(689)
3/8	-8V - BC - 6K	1.45	36.8	0.66	16.8	0.28	7.1	15/16	3/4	11/16	2.54	64.5	19/32	0.44	4300(296)
1/2	-8V - BC - 8K	1.65	41.9	0.90	22.9	0.40	10.2	15/16	15/16	7/8	2.74	69.6	25/32	0.50	4300(296)

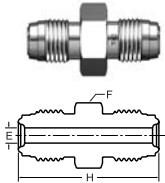

Double Male Union

Ordering Number	E		F Hex Flat	H		Working Pressure (SS) psig(bar)
	in.	mm		in.	mm	
- 2V - UB	0.09	2.3	3/8	1.13	28.7	11200(771)
- 4V - UB	0.18	4.6	5/8	1.55	39.4	10000(689)
- 8V - UB	0.40	10.2	15/16	1.84	46.7	4300(296)
- 12V - UB	0.62	15.7	1-5/16	2.44	62.0	3700(254)
- 16V - UB	0.87	22.1	1-5/8	2.59	65.8	3000(206)

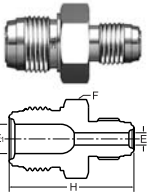

Double Male Reducing Union

Ordering Number	E		E ₁		F Hex Flat	H		Working Pressure (SS) psig(bar)
	in.	mm	in.	mm		in.	mm	
- 8V - UB - 4V	0.18	4.6	0.40	10.2	15/16	1.71	43.4	4300(296)

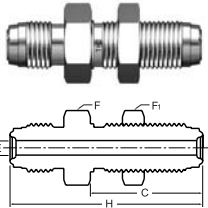

Bulkhead Union

Ordering Number	C		E		F Hex Flat	F ₁ Hex Flat	H		Panel Hole Size	Max Panel Thick- ness	Working Pressure (SS) psig(bar)
	in.	mm	in.	mm			in.	mm			
- 4V - BU	1.30	33.0	0.18	4.6	3/4	3/4	2.23	56.6	19/32	0.44	10000(689)
- 4V - BSU	0.99	25.1	0.18	4.6	3/4	3/4	1.82	46.2	19/32	0.13	10000(689)
- 8V - BU	1.48	37.6	0.40	10.2	1-1/16	1-1/16	2.57	65.3	29/32	0.50	4300(296)
- 8V - BSU	1.11	28.2	0.40	10.2	1-1/16	1-1/16	2.14	54.4	29/32	0.13	4300(296)

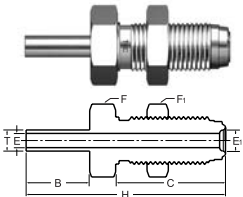

Tube Butt Weld Bulkhead Connector

T Tube OD	Ordering Number	B		C		E		E ₁		F Hex Flat	F ₁ Hex Flat	H		Panel Hole Size	Max Panel Thick- ness	Working Pressure (SS) psig(bar)
		in.	mm	in.	mm	in.	mm	in.	mm			in.	mm			
Fractional																
1/4	-4V - BC - 4T3	0.75	19.1	1.30	33.0	0.18	4.6	0.22	5.6	3/4	3/4	2.36	59.9	19/32	0.44	5100(351)
1/4	-4V - BSC - 4T3	0.75	19.1	0.99	25.1	0.18	4.6	0.22	5.6	3/4	3/4	1.95	49.5	19/32	0.13	5100(351)

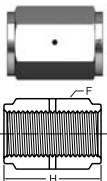

Coupling

Ordering Number	F Hex Flat	H		Ordering Number	F Hex Flat	H	
		in.	mm			in.	mm
- 2VF - PB	7/16	0.66	16.8	- 12VF - PB	1-1/2	1.68	42.7
- 4VF - PB	3/4	1.19	30.2	- 16VF - PB	1-3/4	2.04	51.8
- 8VF - PB	1-1/16	1.31	33.3				

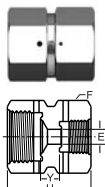

Double Female Reducing Union

Ordering Number	E		F Hex Flat	H		Y		Working Pressure (SS) psig(bar)
	in.	mm		in.	mm	in.	mm	
- 8VF - UB - 4VF	0.25	6.4	1-1/16	1.41	35.8	0.35	8.9	4300(296)

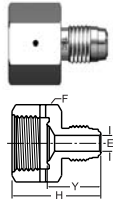

Reducing Adapter

Ordering Number	E		F Hex Flat	H		Y		Working Pressure (SS) psig(bar)
	in.	mm		in.	mm	in.	mm	
<input type="checkbox"/> - 2V - AB - 4VF	0.09	2.3	3/4	1.19	30.2	0.69	17.5	10000(689)
<input type="checkbox"/> - 4V - AB - 8VF	0.18	4.6	1-1/16	1.41	35.8	0.85	21.6	4300(296)

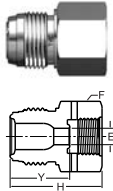

Reducing Bushing

Ordering Number	E		F Hex Flat	H		Y		Working Pressure (SS) psig(bar)
	in.	mm		in.	mm	in.	mm	
<input type="checkbox"/> - 8V - BB - 4VF	0.25	6.4	15/16	1.41	35.8	0.91	23.1	4300(296)

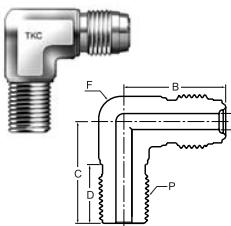

VCR To NPT Elbow

P Male NPT Size	Ordering Number	B		C		D		E		F Wrench Flat	Working Pressure (SS) psig(bar)
		in.	mm	in.	mm	in.	mm	in.	mm		
Fractional											
1/8	<input type="checkbox"/> -4V - CEB - 2N	1.07	27.2	0.87	22.1	0.38	9.6	0.18	4.6	1/2	10000(689)
1/4	<input type="checkbox"/> -4V - CEB - 4N	1.07	27.2	1.05	26.7	0.56	14.2	0.18	4.6	1/2	8000(551)
3/8	<input type="checkbox"/> -8V - CEB - 6N	1.45	36.8	1.26	32.0	0.56	14.2	0.40	10.2	13/16	4300(296)
1/2	<input type="checkbox"/> -8V - CEB - 8N	1.45	36.8	1.45	36.8	0.75	19.1	0.40	10.2	13/16	4300(296)

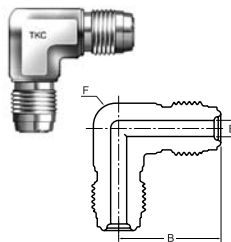

Union Elbow

Ordering Number	B		E		F Wrench Flat	Working Pressure (SS) psig(bar)
	in.	mm	in.	mm		
<input type="checkbox"/> - 2V - UEB	0.89	22.6	0.09	2.3	7/16	11200(771)
<input type="checkbox"/> - 4V - UEB	1.07	27.2	0.18	4.6	1/2	10000(689)
<input type="checkbox"/> - 8V - UEB	1.45	36.8	0.40	10.2	13/16	4300(296)
<input type="checkbox"/> - 12V - UEB	1.92	48.8	0.62	15.7	1-1/4	3700(254)
<input type="checkbox"/> - 16V - UEB	2.00	50.8	0.87	22.1	1-11/16	3000(206)

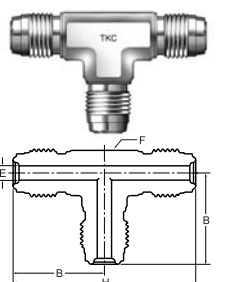

Union Tee

Ordering Number	B		E		H		F Wrench Flat	Working Pressure (SS) psig(bar)
	in.	mm	in.	mm	in.	mm		
<input type="checkbox"/> - 2V - UTB	0.89	22.6	0.09	2.3	1.78	45.2	7/16	11200(771)
<input type="checkbox"/> - 4V - UTB	1.07	27.2	0.18	4.6	2.14	54.4	1/2	10000(689)
<input type="checkbox"/> - 8V - UTB	1.45	36.8	0.40	10.2	2.90	73.7	13/16	4300(296)
<input type="checkbox"/> - 12V - UTB	1.92	48.8	0.62	15.7	3.84	97.5	1-1/4	3700(254)
<input type="checkbox"/> - 16V - UTB	2.00	50.8	0.87	22.1	4.00	101.6	1-11/16	3000(206)

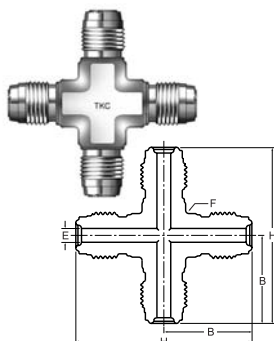

Union Cross

Ordering Number	B		E		H		F Wrench Flat	Working Pressure (SS) psig(bar)
	in.	mm	in.	mm	in.	mm		
<input type="checkbox"/> - 2V - UCB	0.89	22.6	0.09	2.3	1.78	45.2	7/16	11200(771)
<input type="checkbox"/> - 4V - UCB	1.07	27.2	0.18	4.6	2.14	54.4	1/2	10000(689)
<input type="checkbox"/> - 8V - UCB	1.45	36.8	0.40	10.2	2.90	73.7	13/16	4300(296)
<input type="checkbox"/> - 12V - UCB	1.92	48.8	0.62	15.7	3.84	97.5	1-1/4	3700(254)
<input type="checkbox"/> - 16V - UCB	2.00	50.8	0.87	22.1	4.00	101.6	1-11/16	3000(206)

Welded Assemblies

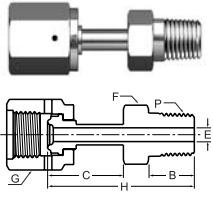

Male NPT Connector Welded Assemblies

P Male NPT Size	Ordering Number	B		C		E		F Hex Flat	G Hex Flat	H		Working Pressure (SS) psig(bar)
		in.	mm	in.	mm	in.	mm			in.	mm	
Fractional												
1/8	<input type="checkbox"/> -4VF - CW - 2N	0.38	9.6	0.95	24.1	0.18	4.6	7/16	3/4	1.58	40.1	8000(551)
1/4	<input type="checkbox"/> -4VF - CW - 4N	0.56	14.2	0.92	23.4	0.18	4.6	9/16	3/4	1.79	45.5	8000(551)
3/8	<input type="checkbox"/> -8VF - CW - 6N	0.56	14.2	1.00	25.4	0.40	10.2	11/16	1-1/16	1.89	48.0	4300(296)
1/2	<input type="checkbox"/> -8VF - CW - 8N	0.75	19.1	1.01	25.6	0.40	10.2	7/8	1-1/16	2.09	53.1	4300(296)

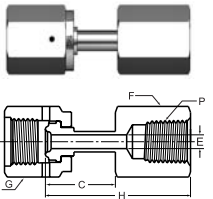

Female NPT Connector Welded Assemblies

P Female NPT Size	Ordering Number	C		E		F Hex Flat	G Hex Flat	H		Working Pressure (SS) psig(bar)
		in.	mm	in.	mm			in.	mm	
Fractional										
1/4	<input type="checkbox"/> -4VF - CW - 4NF	0.92	23.4	0.18	4.6	3/4	3/4	1.77	45.0	6600(454)
3/8	<input type="checkbox"/> -8VF - CW - 6NF	1.06	26.9	0.40	10.2	7/8	1-1/16	1.95	49.5	4300(296)
1/2	<input type="checkbox"/> -8VF - CW - 8NF	1.04	26.4	0.40	10.2	1-1/16	1-1/16	2.18	55.4	4300(296)

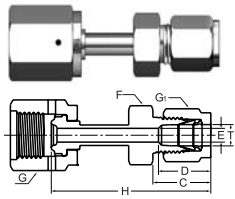

Superlok Tube Fitting Connector Welded Assemblies

T Tube OD	Ordering Number	C		D		E		F Hex Flat	G Hex Flat	G ₁ Hex Flat	H		Working Pressure (SS) psig(bar)
		in.	mm	in.	mm	in.	mm				in.	mm	
Fractional													
1/4	<input type="checkbox"/> -4VF - CW - 4K	0.70	17.8	0.60	15.2	0.18	4.6	1/2	3/4	9/16	1.94	49.3	10000(689)
3/8	<input type="checkbox"/> -4VF - CW - 6K	0.76	19.3	0.66	16.8	0.18	4.6	5/8	3/4	11/16	1.97	50.0	6500(447)
1/2	<input type="checkbox"/> -8VF - CW - 8K	0.86	21.8	0.90	22.9	0.40	10.2	13/16	1-1/16	1-7/8	2.23	56.6	4300(296)

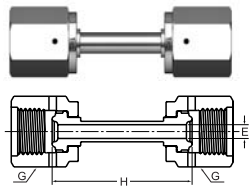

Rotating Female Union Welded Assemblies

Ordering Number	E		G Hex Flat	H		Working Pressure (SS) psig(bar)
	in.	mm		in.	mm	
Fractional						
<input type="checkbox"/> - 4VF - UW	0.18	4.6	3/4	1.71	43.4	10000(689)
<input type="checkbox"/> - 8VF - UW	0.40	10.2	1-1/16	1.84	46.7	4300(296)

Female Elbow Welded Assemblies

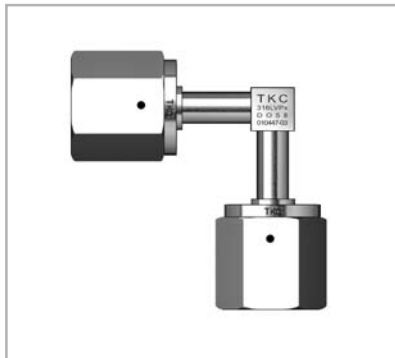

Ordering Number / - 4VF - UEW

Female Tee Welded Assemblies

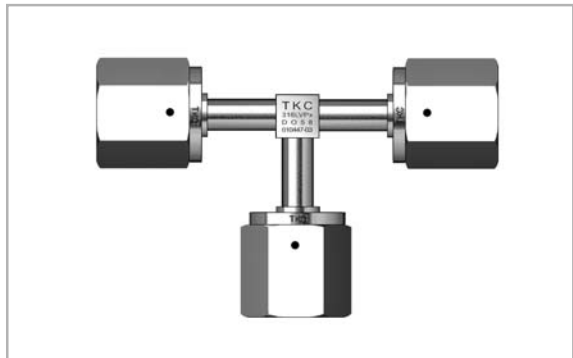

Ordering Number / - 4VF - UTW

Gaskets



Non-Retained Gasket

Basic Ordering Number	E		H		Tx	
	in.	mm	in.	mm	in.	mm
<input type="checkbox"/> - 2V - NR	0.09	2.3	0.028	0.7	0.26	6.6
<input type="checkbox"/> - 4V - NR	0.22	5.6	0.028	0.7	0.47	11.9
<input type="checkbox"/> - 8V - NR	0.44	11.2	0.028	0.7	0.78	19.8
<input type="checkbox"/> - 12V - NR	0.66	16.8	0.028	0.7	1.14	29.0
<input type="checkbox"/> - 16V - NR	0.89	22.6	0.028	0.7	1.40	35.6



Gasket Retainer Assemblies

Basic Ordering Number	E		H		Tx	
	in.	mm	in.	mm	in.	mm
<input type="checkbox"/> - 4V - GR	0.24	6.1	0.028	0.7	0.50	12.7
<input type="checkbox"/> - 8V - GR	0.44	11.2	0.028	0.7	0.79	20.1
<input type="checkbox"/> - 12V - GR	0.66	16.8	0.028	0.7	1.14	29.0
<input type="checkbox"/> - 16V - GR	0.89	22.6	0.028	0.7	1.40	35.6

Nuts, Caps, and Plugs

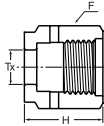

Female Nut

Ordering Number	F Hex Flat	H		Tx	
		in.	mm	in.	mm
<input type="checkbox"/> - 2V - FN	7/16	0.53	13.5	0.21	5.3
<input type="checkbox"/> - 4V - FN	3/4	0.81	20.6	0.36	9.1
<input type="checkbox"/> - 8V - FN	1-1/16	0.88	22.4	0.61	15.5
<input type="checkbox"/> - 12V - FN	1-1/2	1.12	28.4	0.89	22.6
<input type="checkbox"/> - 16V - FN	1-3/4	1.34	34.0	1.20	30.5

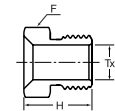

Male Nut

Ordering Number	F Hex Flat	H		Tx	
		in.	mm	in.	mm
<input type="checkbox"/> - 2V - MN	3/8	0.50	12.7	0.21	5.3
<input type="checkbox"/> - 4V - MN	5/8	0.71	18.0	0.36	9.1
<input type="checkbox"/> - 8V - MN	15/16	0.81	20.6	0.61	15.5
<input type="checkbox"/> - 12V - MN	1-5/16	1.00	25.4	0.89	22.6
<input type="checkbox"/> - 16V - MN	1-5/8	1.19	30.2	1.20	30.5

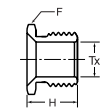

Short Male Nut

Ordering Number	F Hex Flat	H		Tx	
		in.	mm	in.	mm
<input type="checkbox"/> - 4V - SMN	5/8	0.54	13.7	0.36	9.1
<input type="checkbox"/> - 4V - SMN - X9	5/8	0.65	16.5	0.36	9.1

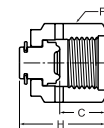

Cap

Ordering Number	C		F Hex Flat	H	
	in.	mm		in.	mm
<input type="checkbox"/> - 2V - CP	0.30	7.6	7/16	0.63	16.0
<input type="checkbox"/> - 4V - CP	0.44	11.2	3/4	0.94	23.9
<input type="checkbox"/> - 8V - CP	0.45	11.4	1-1/16	1.01	25.6
<input type="checkbox"/> - 12V - CP	0.54	13.7	1-1/2	1.29	32.8
<input type="checkbox"/> - 16V - CP	0.63	16.0	1-3/4	1.54	39.1

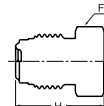

Plug

Ordering Number	F Hex Flat	H		Ordering Number	F Hex Flat	H	
		in.	mm			in.	mm
<input type="checkbox"/> - 2V - PG	3/8	0.68	17.3	<input type="checkbox"/> - 12V - PG	1-5/16	1.43	36.3
<input type="checkbox"/> - 4V - PG	5/8	0.92	23.4	<input type="checkbox"/> - 16V - PG	1-5/8	1.52	38.6
<input type="checkbox"/> - 8V - PG	15/16	1.08	27.4				

High-Flow Connections - "H" Type

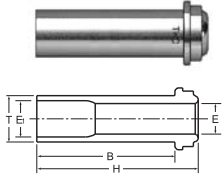

Tube Butt Weld Long Glands

T Tube OD	Ordering Number	B		E		E _i		H		Normal Wall Thickness	Working Pressure (SS) psig(bar)
		in.	mm	in.	mm	in.	mm	in.	mm		
Fractional											
3/8	-4V - HG - 6T6	0.41	10.4	0.25	6.4	0.31	7.9	0.60	15.2	0.035	3300(227)
3/8	-4V - HG - 6T11	1.00	25.4	0.25	6.4	0.31	7.9	1.19	30.2	0.035	3300(227)
3/8	-4V - HG - 6T12	1.12	28.4	0.25	6.4	0.31	7.9	1.31	33.3	0.035	3300(227)

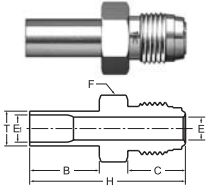

Tube Butt Weld Body

T Tube OD	Ordering Number	B		C		E		E _i		F Hex Flat	H		Working Pressure (SS) mm
		in.	mm	in.	mm	in.	mm	in.	mm				
Fractional													
3/8	-4V - HCB - 6T3	0.75	19.1	0.62	15.7	0.25	6.4	0.31	7.9	5/8	1.68	42.7	3300(227)

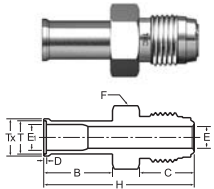

Automatic Tube Weld Body

T Tube OD	Ordering Number	B		C		D		E		E _i		F Hex Flat	H		Tx	Working Pressure (SS) psig(bar)	
		in.	mm	in.	mm	in.	mm	in.	mm	in.	mm						
Fractional																	
3/8	-4V - HBC - 6T3	0.75	19.1	0.62	15.7	0.03	0.8	0.25	6.4	0.31	7.9	5/8	1.71	43.4	0.41	10.4	3300(227)

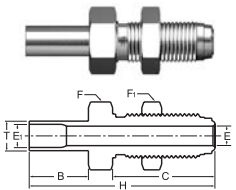

Bulkhead Connector Body

T Tube OD	Ordering Number	B		C		E		E _i		F Hex Flat	F ₁ Hex Flat	H		Panel Hole Size	Max Panel Thickness	Working Pressure (SS) psig(bar)
		in.	mm	in.	mm	in.	mm	in.	mm							
Fractional																
3/8	-4V - HBC - 6T3	0.75	19.1	1.30	33.0	0.25	6.4	0.31	7.9	3/4	3/4	2.36	59.9	19/32	0.44	3300(227)

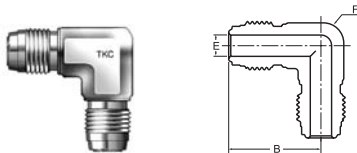

Union Elbow Body

Ordering Number	B		E		F Wrench Flat	Working Pressure (SS) psig(bar)
	in.	mm	in.	mm		
-4V - HUEB	1.07	27.2	0.25	6.4	1/2	10000(689)

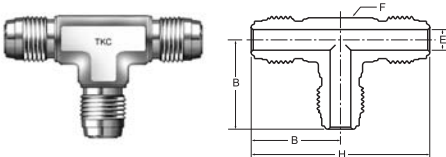

Union Tee Body

Ordering Number	B		E		H		F Wrench Flat	Working Pressure (SS) psig(bar)
	in.	mm	in.	mm	in.	mm		
-4V - HUTB	1.07	27.2	0.25	6.4	2.14	54.4	1/2	10000(689)

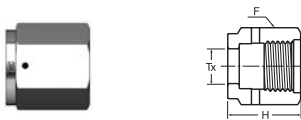

Female Nut

Ordering Number	F Hex Flat	H		Tx	
		in.	mm	in.	mm
-4V - HFN	3/4	0.81	20.6	0.39	9.9



Male Nut

Ordering Number	F Hex Flat	H		Tx	
		in.	mm	in.	mm
-4V - HMN	5/8	0.71	18.0	0.39	9.9

Handling

Damage to the sealing beads may affect the fitting performance. A protective cap is placed on all Face Seal Fitting sealing beads to prevent nicks or scratches. Keep this cap in place during storage and handling and only remove prior to assembly.

Retainer Assembly

Step 1

When using a gasket retainer assembly, axially press the assembly onto the gland as shown. The retainer assembly will locate the gasket over the bead and hold it in place. Be careful not to scratch or nick the bead as this may affect fitting performance.



Proceed to Step 2



Non - Retainer Assembly

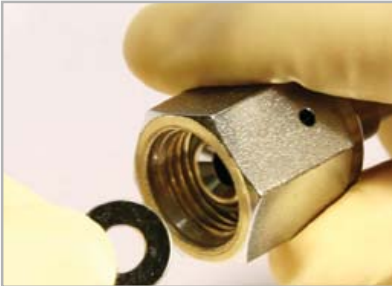

Step 1
Place gasket into female nut.



Step 3
Scribe the hex flat of both the male and female



Step 2
Assemble components and snug to fingertight.



Step 4
Holding the backup wrench stationary, tighten the female nut 1/8 turn past fingertight. **Warning:** Extreme over tightening will damage toroid surface and cause potential leakage.

Protective Cap

Removing Face Seal in an assembled system requires minimal clearance. To disassemble a face seal connection, hold the male nut or body hex stationary with a backup wrench and loosen the female nut. After removing the components, be sure to protect the sealing beads with protective caps or gasket retainer assemblies.





TK corporation

1579-1 Songjeong-dong,
Gangseo-gu, Busan, Korea
TEL. 82-51-970-6700 FAX. 82-51-831-1215
E-mail:tkscd@tkscct.com
<http://www.tkscct.com>

EXPORT & IMPORT SUBSIDIARY COMPANY :

DAESHIN INTERNATIONAL Co., Ltd.
801 Jeong-sun Bldg, 1270-1, Jwa-dong,
Haeundae-gu, Busan, Korea
TEL. 82-51-747-8103~8
FAX. 82-51-747-8444~5
E-mail:sean1012@tkbend.co.kr