

PARTS LIST - MRH001 Section			
ITEM	QTY	PART NUMBER	DESCRIPTION
1	1	ARD-1024	Roof Deck Hand Rail
2	1	ARD-1025	Mid-Rail
3	1	MR-H01	Mid Roof Handrail Base Ring
4	1	MR-H02	Mid Roof Handrail Outer Ring
5	1	MR-H03	Mid Roof Handrail Post
6	1	MR-H04	Mid Roof Handrail Post Brace
7	varies	* MRV_1	Mount Foot (varies by bin brand)

* Mount foot must be ordered separately.

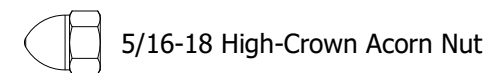
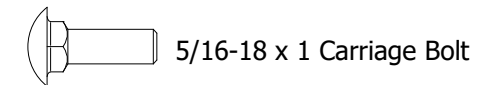
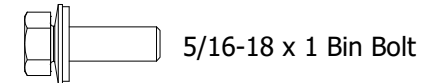
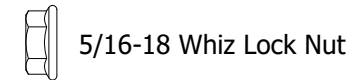
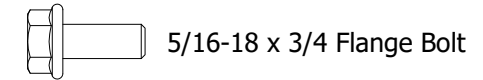

DRAWN Bill Huff	12/14/2017	Greene Galvanized Stairs East Lynn, IL 217.375.4244 www.greenebinstairs.com	
CHECKED		TITLE	
QA		Mid Roof Handrail	
MFG		SIZE A	DWG NO MRH001
APPROVED		SCALE 1 / 12	REV 1
		SHEET 1 OF 2	

How to Calculate Parts Needed for Mid-Roof Handrail

Number of Sections: One Mid-Roof Handrail section (MRH001) for each foot of desired diameter.

Number of Roof Mounts: One Roof Mount (MRV_1) for each roof panel covered by the Mid-Roof Handrail. Never more than 2 mounts per section of handrail.

Number of Entries: One entry section (MRHE01) for each instance that you need to pass through the Mid-Roof Handrail. Typically, at least 1 entry section will be required for each system.

The Mid-Roof Handrail requires 24" of roof run / clear space outside of the handrail to allow for mounting hardware.

Example: If the handrail will be placed halfway down the roof of a 60' diameter bin, the handrail diameter (inside diameter) will be 30', so a Qty of 30 MRH001 would be needed. If there are 60 roof panels at the Mid-Roof Handrail roof location, order Quantity 60 MRV_1. Indicate the bin manufacturer when ordering as the mounts are brand specific to correspond to the pre-punched roof rib holes.

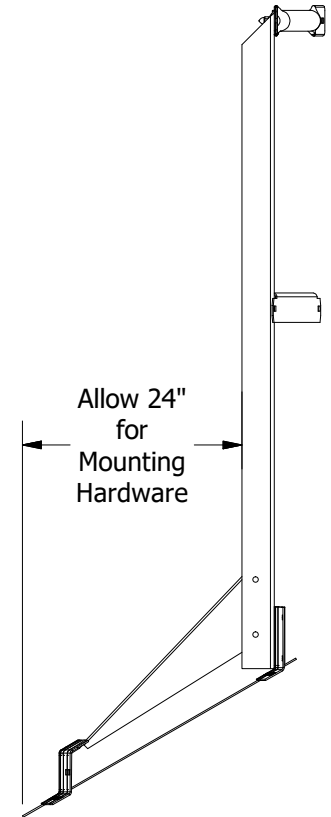
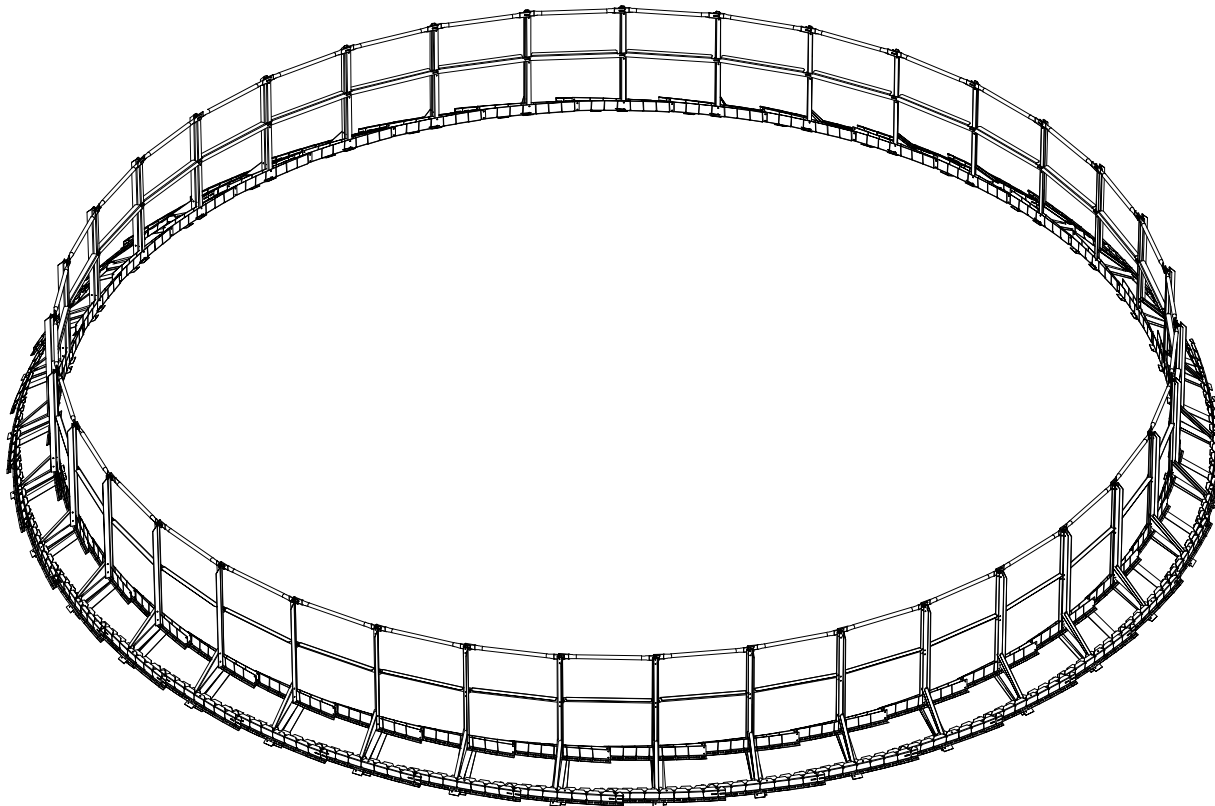

Side View of MRH Section

DRAWN Bill Huff	12/14/2017	Greene Galvanized Stairs East Lynn, IL 217.375.4244 www.greenebinstairs.com	
CHECKED		TITLE	
QA		Mid Roof Handrail	
MFG		SIZE A	DWG NO MRH001
APPROVED		SCALE 1 / 75	REV 1
		SHEET 2 OF 2	