

Visit Us Online

For more information about Basalite paving stones, retaining walls, accessories, patterns or installation instructions visit us online at basalite.com.

Offered by:

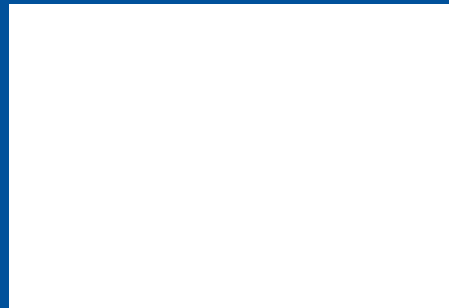

355 Greg Street
Sparks, NV 89431
888-296-3719

CALIFORNIA • COLORADO • IDAHO • NEVADA • WASHINGTON • ALBERTA • BRITISH COLUMBIA

www.basalite.com



©2013 Basalite® Concrete Products, LLC. All trademarks ® are registered trademarks.
The U.S. Green Building Council Member logo is a trademark owned by the U.S. Green Building Council and is used by permission.

BA064d_NV 5000 OMNI 3/07/13



SAN FRANCISCO COBBLESTONE

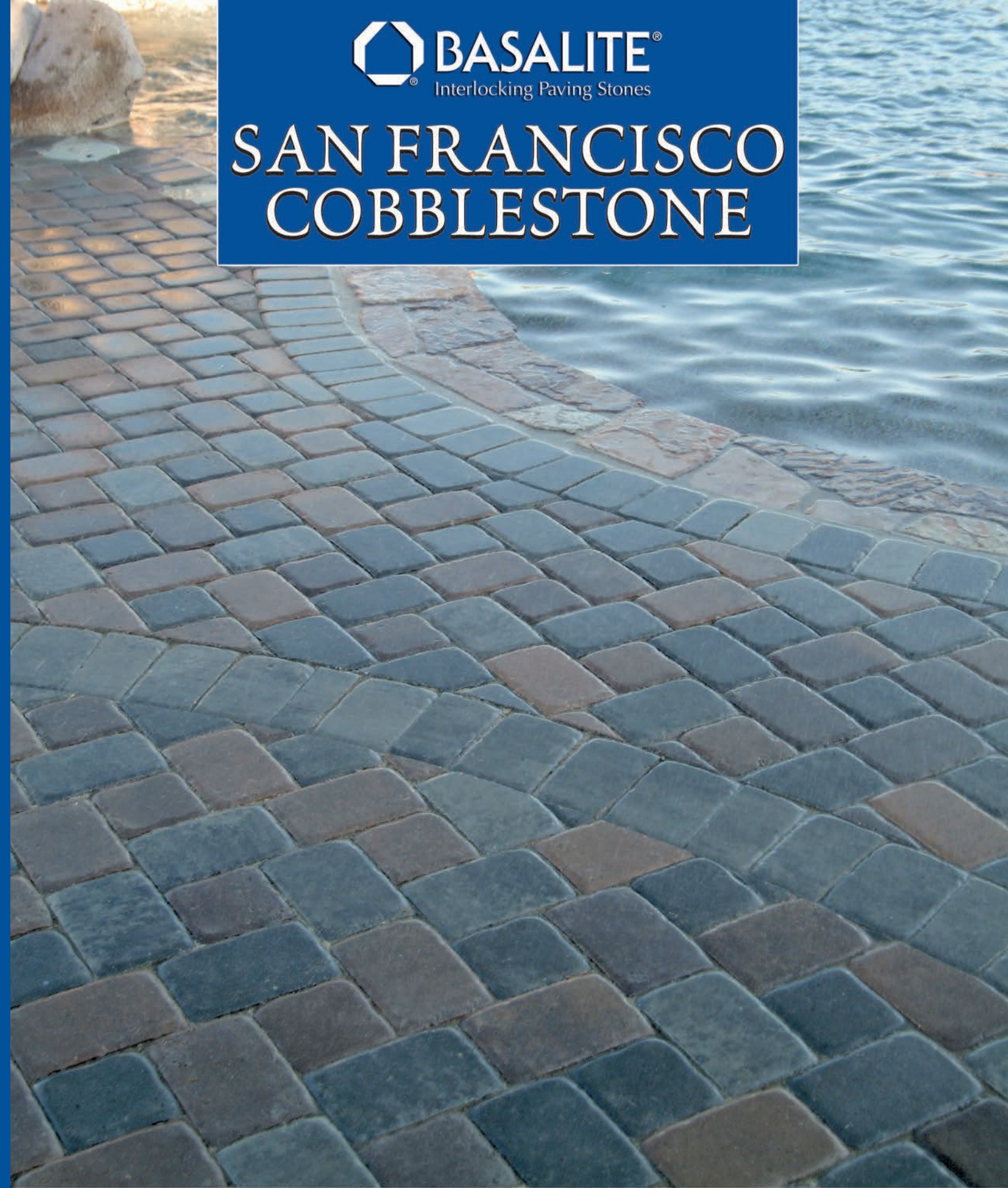

www.basalite.com



SAN FRANCISCO COBBLESTONE

Interlocking Paving Stones

For your hardscape designs that require more formal styling, these pavers offer the traditional look and feel of centuries-old cobbled block. In Renaissance colors, the collection will also provide you with the opportunity to design complementary walls and stairways to complete your personal statement.

Above: San Francisco Cobblestone in Custom Color
Cover: San Francisco Cobblestone in Custom Color

Specifications

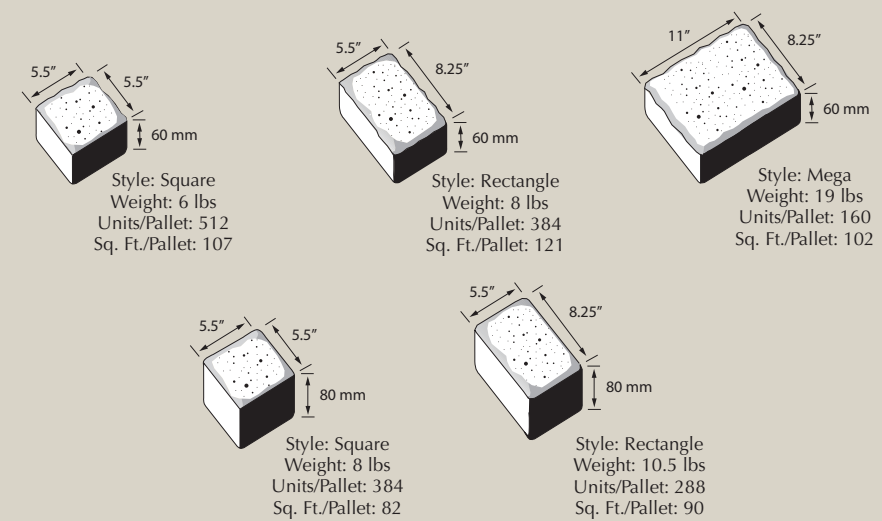

Patterns

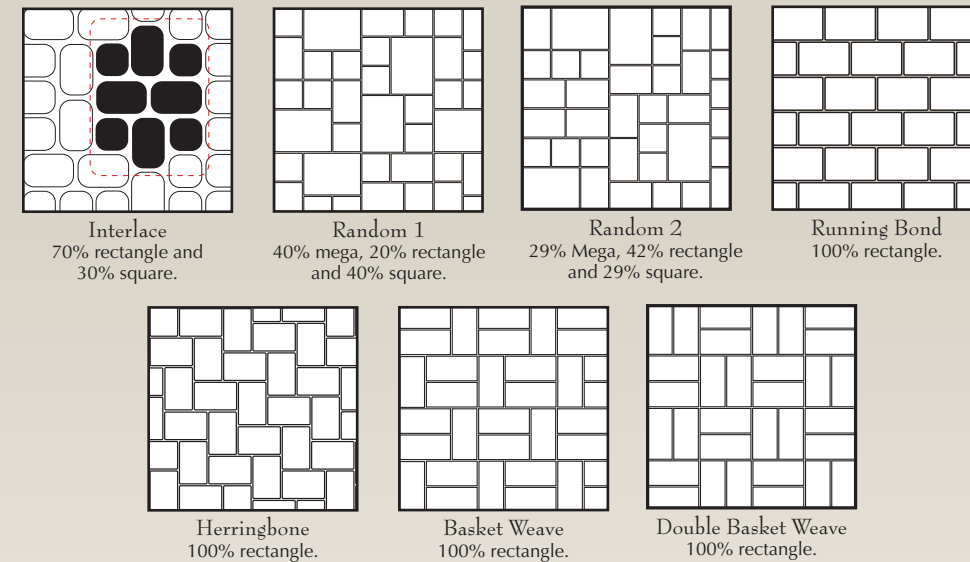

Typical Paver Installation *

1. Excavate unsuitable, unstable or unconsolidated subgrade material and compact the area which has been cleared. Backfill and level with dense graded aggregate suitable for base material (typically 3" - 6" for pedestrian/light vehicular traffic and 8" - 10" for driveway applications), or as otherwise directed by site engineer/architect/landscape architect.
2. Install edge restraint using concrete curb, concrete toe or edging.
3. Place bedding course of sharp normal weight screening or concrete sand to a uniform depth of approximately 1" leveled to grade.
4. Install Basalite Pavers hand tight with joints approximately 1/8". Where required, cut stones with an approved cutter to fit accurately.
5. Tamp pavers with mechanical vibrator, uniformly level true to grade and free of movement.
6. Fill voids in joints by sweeping, dry, fine, sharp sand over pavers.

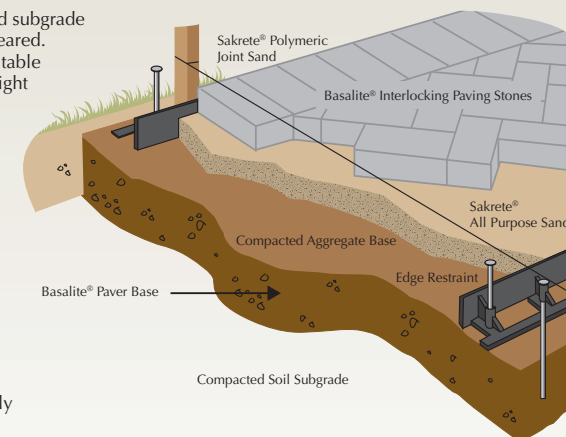

*The installation instructions and illustrations shown are a basic overview of paver installation methods. Because of the variety of applications, please refer to the Basalite® installation guide, or visit us online at basalite.com.

Colors



Carmel



Comstock Blend



Donner Blend



Marin



Mendocino



Milan (Special Order**)



Naples



Pacifica

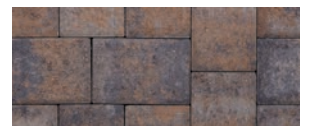

Positano

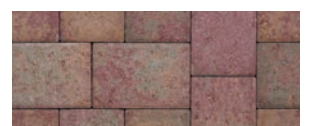

Sienna



Venice

**Milan is available by special order, please allow sufficient lead time. For more information, please contact your local Basalite Representative.

NOTE: Printed colors shown in this brochure may vary from actual product colors. We recommend color selection be made from actual product samples.