

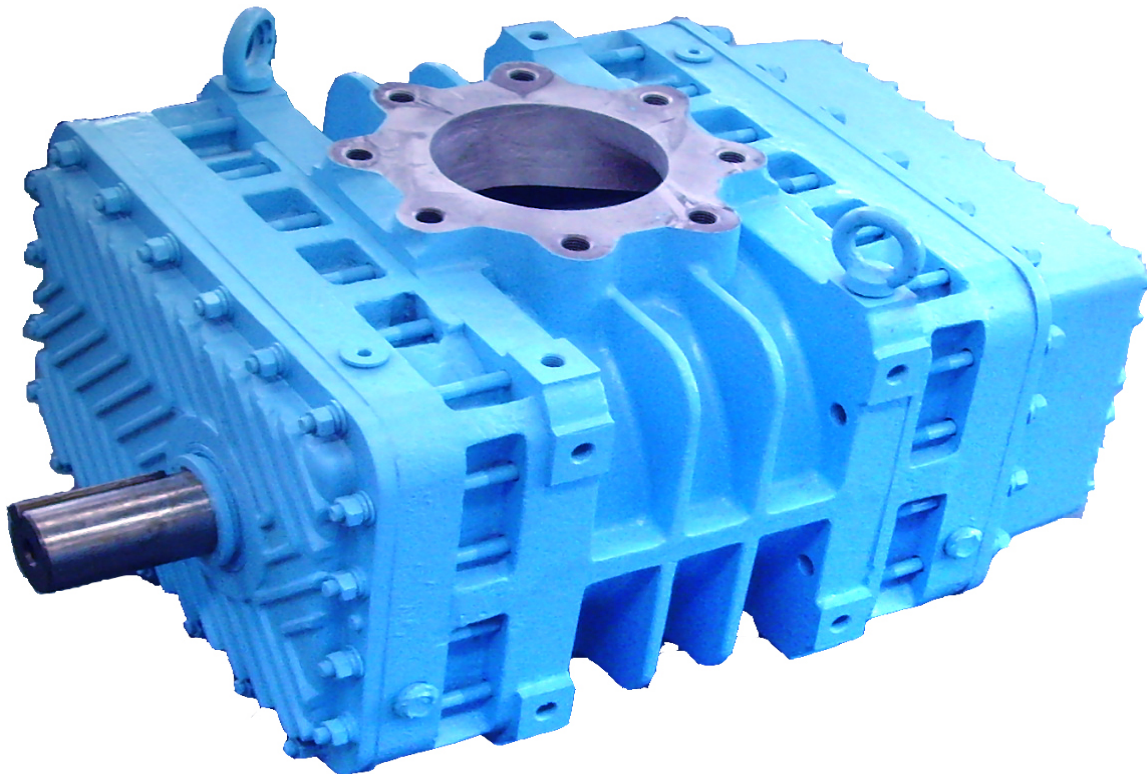

EurusBlower

Rotary Blower Service Manual

**Models: MB3004, MB3006, MB3007,
MB4504, MB4506, MB4509,
MB4512, MB4518, MB6010,
MB6016, MB6024**



04/2011



Table of Contents

1. TECHNICAL SPECIFICATIONS	4
1.1 ROTARY BLOWER SPECIFICATIONS	4
1.2 AMBIENT TEMPERATURE LIMITATIONS.....	6
1.3 OIL CAPACITIES	6
1.4 RECOMMENDED LUBRICANT	6
1.5 NAMEPLATE.....	7
1.6 DIMENSIONAL DRAWINGS	8
1.7 PERFORMANCE CURVES.....	8
1.8 PERFORMANCE TABLES	8
2. SAFETY INSTRUCTIONS.....	8
2.1 WARNING SYMBOLS	8
2.2 WARNING NOTICES ON THE ROTARY BLOWER	9
2.3 SAFETY WARNING AND REGULATIONS (OSHA CFR 29, 19100).....	9
2.4 GENERAL REFERENCES.....	10
3. ARRIVAL AND USE OF THE ROTARY BLOWER.....	11
3.1 ARRIVAL INSPECTION	11
3.2 PROPER USE OF THE ROTARY BLOWER.....	11
4. MOVING AND HANDLING	12
4.1 HANDLING INSTRUCTIONS	12
4.2 HANDLING WITH A FORKLIFT OR PALLET JACK	12
4.3 HANDLING WITH A CRANE HOOK	12
4.4 STORAGE.....	13
4.4.1 Temporary Storage.....	13
4.4.2. Storage for Longer Than One Year	13
4.4.3. Recommended Rust Inhibiting Oils for Storage.....	13
4.4.4. Operating Blower after Long-Term Storage	13
5. OPERATIONAL CHARACTERISTICS AND CONSTRUCTION	14
5.1 OPERATIONAL CHARACTERISTICS	14
5.2 CONSTRUCTION	15
5.3 HORIZONTAL FLOW CONFIGURATION.....	15
5.4 VERTICAL FLOW CONFIGURATION.....	16
6. INSTALLATION AND DESIGN REQUIREMENTS	17
6.1 INSTALLATION REQUIREMENTS.....	17
6.1.1 Typical Blower (Positive Pressure) System Diagram.....	18
6.1.2 Typical Vacuum / Exhaust (Negative Pressure) System Diagram	19
6.2 DRIVE MOTOR.....	20



6.2.1 Direct coupled drive with flexible coupling	21
6.2.2 V-belt drive.....	21
6.3 SYSTEM SAFETY EQUIPMENT	22
6.3.1 Safety relief valve.....	22
6.3.2 Check valve.....	23
6.3.3 Visual Indicators of Temperature and Pressure	23
6.3.4 Monitoring Device switches.....	23
6.3.5 Noise reduction.....	24
7. OPERATING A ROTARY BLOWER.....	25
7.1 PRIOR TO STARTING UNIT FOR FIRST TIME	25
7.2 STARTING AND STOPPING THE ROTARY BLOWER	26
7.3 TROUBLESHOOTING	26
7.3.1 Trouble Shooting Guide	27
8. MAINTENANCE.....	28
8.1 RULES FOR MAINTENANCE.....	28
8.2 REGULAR MAINTENANCE SCHEDULE	28
8.3 OIL LEVEL CHECK	29
8.3.1 Oil Sight Glasses.....	29
8.4 CHANGING THE OIL.....	30
9. SPARE PARTS AND AFTER SALES SERVICE	31
9.1 GENERAL EXPLODED PARTS DIAGRAM.....	31
Model: MB3004 Parts List	32
Model: MB3006 Parts List	33
Model: MB3007 Parts List	34
Model: MB4504 Parts List	35
Model: MB4506 Parts List	36
Model: MB4509 Parts List	37
Model: MB4512 Parts List	38
Model: MB4518 Parts List	39
Model: MB6010 Parts List	40
Model: MB6016 Parts List	41
Model: MB6024 Parts List	42
9.2 GENERAL ITEMIZED DRAWING OF CONFIGURATION	43
10. MAINTENANCE SCHEDULE SHEET	46



1. Technical Specifications

1.1 Rotary Blower Specifications

	MB3004	MB3006	MB3007	MB4504	MB4506
Configuration ¹					
	Vertical or Horizontal Flow				
Direction of Rotation ¹					
	Vertical Flow Configuration: Right drive shaft is CW (STANDARD); left drive shaft is CCW Horizontal Flow Configuration: Top drive shaft is CW (STANDARD)				
Inlet CFM ^{2, 5} (@maximum speed and maximum Δp)					
	202	300	350	385	575
Power Consumption ^{3, 5} (BHP @ maximum speed and maximum Δp)					
Blower (15 psi)	17.1	20.5 (12psi)	20.2 (10psi)	29.2	43.1
Vacuum (15 InHg)	9.5	13.8	16.0	14.3	43.1
Operating Limits					
Max RPM	5,000			4,000	
Max Case Pressure	25 (psi)				
Max Radial Shaft Load	600 (lbf)			850 (lbf)	
Max Δp Blower (psi) ^{4,5}	15	12	10	15	
Max Δp Vacuum ^{4,5}	15 (InHg)				
Max Pressure Ratio ⁴	2:1	1.8:1	1.67:1	2:1	
Max Discharge Temp.	335° F				
Max Inlet Temp.	120° F				
Connection					
Inlet Port (ANSI)	NPT 2"	NPT 2.5"	NPT 2.5"	NPT 2.5"	NPT 4"
Discharge Port (ANSI)					
Weight (lb)					
	108	130	138	240	275

Notes are below the following table



	MB4509	MB4512	MB4518	MB6010	MB6016	MB6024
Configuration ¹						
	Vertical or Horizontal Flow					
Direction of Rotation ¹						
	Vertical Flow Configuration: Right drive shaft is CW(STANDARD); left drive shaft is CCW Horizontal Flow Configuration: Top drive shaft is CW (STANDARD)					
Inlet CFM ^{2, 5} (@maximum speed and maximum Δp)						
	312	423	676	468	786	1314
Power Consumption ^{3,5} (BHP @ maximum speed and maximum Δp)						
Blower (15psi)	63.9	85.2	102 (12psi)	100.5	153.1	183 (12psi)
Vacuum (15InHg)	31.4	41.8	62.6	49.4	75.2	112.3
Operating Limits						
Max RPM	4,000			3,000		
Max Case Pressure	25 (psi)					
Max Radial Shaft Load	850 (lbf)			1,250 (lbf)		
Max Δp Blower(psi) ^{4,5}	15	12		15		12
Max Δp Vacuum ^{4,5}	15					
Max Pressure Ratio ⁴	2:1		1.8:1		2:1	1.8:1
Max Discharge Temp.	335° F					
Max Inlet Temp.	120° F					
Connection						
Inlet Port (ANSI)	NPT 5"	6"-Flange	8"-Flange	6"-Flange	8"-Flange	10"-Flange
Discharge Port (ANSI)						
Weight (lb)						
	325	385	473	673	881	1123

Notes:

1. The user can select the configuration according to their installation requirements.
2. The effective volume flow is dependent on the speed and the differential pressure.
3. The power consumption is dependent upon the operating point required, e.g. volume-flow and differential pressure.
4. The ratings based on inlet air at standard pressure of 14.7 psia, standard temperature of 68 degrees F, and specific gravity of 1.0.
5. Δp = discharge pressure – inlet pressure



1.2 Ambient Temperature Limitations

Minimum ambient temperature * 5 °F
Maximum ambient temperature * 120 °F

* These temperature limits are based on lubricants specified within this manual. Consult Eurus Blower for recommendations if operating environment temperatures exceed these limits (see lubricant recommendations, section 1.4).

1.3 Oil Capacities

Model		MB3004~MB3007	MB4504~MB4518	MB6010~MB6024
Drive end	Horizontal Flow Configuration	5 oz	14 oz	38 oz
Gear end		9 oz	28 oz	70 oz
Drive end	Vertical Flow Configuration	7.5 oz	23 oz	55 oz
Gear end		13.5 oz	49 oz	115 oz

1.4 Recommended Lubricant

Use the recommended grade and viscosity of industrial type, non-detergent, rust inhibiting, anti-foaming oil (Reference Figure 1 below). The correct oil depends on the range of ambient temperatures as well as the range of discharge temperatures.



RECOMMENDED VISCOSITY

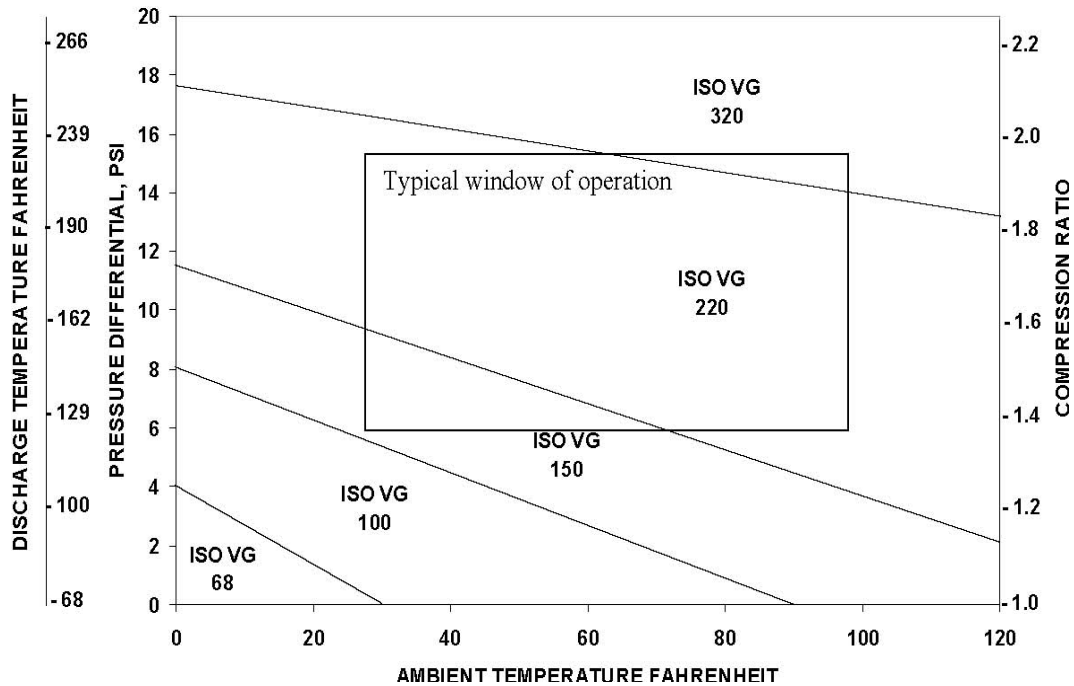

Figure 1

Synthetic lubricants are highly recommended over mineral lubricants: synthetics last up to 4 times longer; and a single viscosity can cover a broader temperature range.

Consult factory for oil recommendations on special applications.

1.5 Nameplate

The nameplate of the rotary blower is located on the gear-side end plate of the unit.



EurusBlower

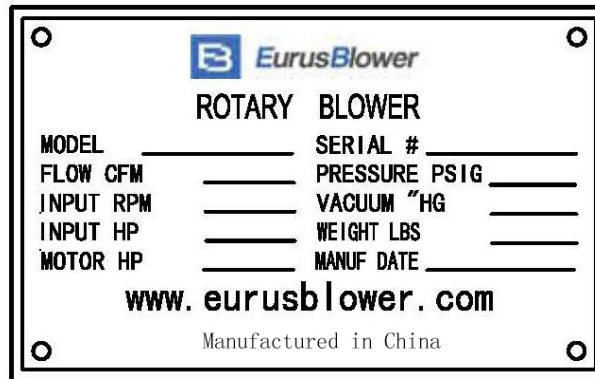

1.6 Dimensional Drawings

Documents can be provided by Eurus Blower Customer Service Department

1.7 Performance Curves

Performance curves can be provided by Eurus Blower Customer Service Department

1.8 Performance Tables

Performance tables can be provided by Eurus Blower Customer Service Department

2. Safety Instructions

Read this service manual carefully and abide by all warnings and precautions before installing the rotary blower and/or before performing any maintenance.

2.1 Warning Symbols

Symbol	Meaning
	This symbol indicates information that can cause injury or death. It is critical that these rules are observed and that extreme care is taken in these cases. For their own protection, inform all other users of these safety rules. Observe general safety and accident prevention rules as well as the safety procedures in this manual.



	<p>This symbol indicates considerable attention must be paid to recommendations, regulations, references and correct sequencing so that damage and/or destruction of the rotary blower and/or other equipment is prevented.</p>
	<p>This symbol indicates environmental protection measures.</p>
	<p>This symbol indicates manual operations that are to be performed by the operator or service technician.</p>

2.2 Warning notices on the rotary blower

<p>Warning!</p> <p>Hot Surface Do Not Touch!</p>	<p>Warning!</p> <p>No Operation Without Guards!</p>	<p>Warning!</p> <p>Hearing Protection Required!</p>	<p>Warning!</p> <p>Keep Away From Open Ports!</p>
--	---	---	---

2.3 Safety warning and regulations (OSHA CFR 29, 19100)



Observe the following warnings when operating rotary blowers:

- **Because of danger to maintenance and operation personnel from rotating parts, high temperatures and harmful noise, protective measures against these hazards must be taken by the user.**



-
- **No open flame or flying sparks should be in the vicinity of unit.**
 - **If any welding or grinding work is needed near the rotary blower, ensure that sparks or high temperatures cannot cause fire or explosion.**
 - **Operating personnel must be instructed on the necessity of wearing hearing protection during operation of the rotary blower - especially when operating without the acoustic hood.**
 - **Do not stay for long periods in the direct vicinity of operating rotary blowers with hazardous or dangerous noise levels.**
 - **Do not use rotary blowers to convey or handle explosive or dangerous gases.**
 - **Because of the high temperatures generated (up to 335° F), do not touch pipes or ancillaries during operation of the rotary blower. Wait until the blower has cooled down and pressure is vented before performing any repairs.**
 - **Only specially trained personnel should work on power driven systems.**

2.4 General References

Attention!

The rotary blower is not capable of functioning as an independent machine: it is designed as a sub-component to be used and controlled within a bigger system.

The rotary blower may only be put into operation as an integral part of a complete system that has been subjected to a safety inspection proving that it conforms to the requirements of relevant safety regulations (see OSHA CFR 29, 1910)



3. Arrival and Use of the Rotary Blower

3.1 Arrival Inspection



Before accepting the shipment, perform the following inspections:

- Review the packing slip and verify that all components and accessories are included and undamaged. Uncrate, or remove packing from, all items and inspect them thoroughly. Report any damage or missing items described on the packing slip with the carrier.
- Rotate the shaft and insure smooth rotation by hand. If the contamination covers are still on the inlet and outlet of the unit, expect some resistance when turning the shaft.
- Do not remove port covers. A rust inhibitor is applied at the factory to insure rust free air chamber. Wait until installation before removing covers. Once removed, the air chamber will be exposed to dirt and debris and the rust inhibitor will begin to evaporate.

3.2 Proper Use of the Rotary Blower

The rotary blower unit is intended solely for the transport of oil-free air or any inert gas without any liquids or solids; and in conformity with the technical specifications.

For special gas applications contact Eurus Blower's Engineering Department.

Attention!

Do not use this blower for any combustible or oxidizing gas applications.

Any other use is considered improper and will void the warranty and may cause injury or death. The manufacturer cannot accept liability for any damage caused by improper use. The user is solely liable for any risks incurred.

Correct use also means compliance with the installation, removal, commissioning, operational and maintenance instructions written in this manual.

This service manual is intended for operating, maintenance and supervisory personnel use only.



4. Moving and Handling

4.1 Handling Instructions

To avoid damage to the rotary blower, it is recommended to use a forklift truck, pallet jack, hoist, crane, chain, cable or a sling with certified capacities according to safety (see chapter 2). Abide by all safety and regulatory procedures when handling rotary blowers.

4.2 Handling with a Forklift or Pallet Jack

Always place the rotary blower on a suitable pallet, box or platform to prevent tipping. Be sure the platform can support the full weight of the unit. Directly fasten the rotary blower to the structure using the mounting feet provided - prior to moving the unit.

Attention!

Do not lift rotary blower unit directly with the forks of a forklift or pallet jack: this can cause injury to operator and damage to the unit.

4.3 Handling with a Crane Hook

When lifting the rotary blower with a crane hook and slings, use the two eyebolts provided. Screw these eyebolts into the threaded holes in the upper mounting to distribute the load evenly.

Attention!



- **When transporting the rotary blower with a crane, all standard safety practices and regulations regarding this type of operation must be observed.**
- **Do not stand below a hanging load.**
- **Do not exceed the maximum permissible lifting weight specified for the lifting device and rigging elements.**
- **Take care that the eyebolts are screwed fully into the block. Avoid sudden, sharp vertical movements when lifting, lowering and transporting the rotary blower.**
- **Lift the load no higher than necessary to move.**



4.4 Storage

4.4.1 Temporary Storage

If the unit will need to be stored for a short period of time, or there is a long period of time between delivery and installation, store the rotary blower in a dry, covered space. Leave the flanged ports blanked off to prevent contamination of the internal surfaces. Keep the unit off of the ground.

4.4.2. Storage for Longer Than One Year

Use Temporary Storage 4.4.1 recommendations plus:

- Apply rust inhibiting oil/grease onto the flanged ports, drive shaft, air chamber and any other base metal to protect against corrosion.
- Isolate from secondary vibration
- Change the lubricating oil annually (see chapter 8.4)
- Rotate shaft periodically (a few times two weeks is recommended)

4.4.3. Recommended Rust Inhibiting Oils for Storage

External:

- Exxon Rust Ban 326
- Mobil Mobilarma 777 OR 778
- Shell V-Product 9703

Internal:

- Mobil Mobilarma 523 or 524
- Shell Rimula 30 or Rotella T 20W20

4.4.4. Operating Blower after Long-Term Storage

To operate the unit after long-term storage, perform the following:

- Remove preservative oil from the air chamber with a suitable solvent.
- Perform the standard measures for installing a new unit.
- Change the lubricating oil (see Chapter 8.4)



5. Operational Characteristics and Construction

5.1 Operational Characteristics

To develop pressure and move air, two bi-lobe rotors, synchronized by a pair of timing gears, rotate in opposite directions in two cylindrical bores within the housing.

A defined quantity of air entering the inlet port is trapped between the rotor and the housing and is carried over to the discharge port against the pressure from the application. The pressure developed depends upon the resistance of the system as well as the inlet and discharge pressures.

Each trapped volume occurs two times every revolution for each rotor, commonly referred to as the volume flow per revolution. Multiplying this by the shaft speed will define the flow rate entering the inlet port. Changing the rotational speed directly affects the volume flow.

Simultaneously, the synchronized rotors and housing serve to prevent back flow by the close proximity of the rotors to one another and the proximity of the rotors to the housing.

Because there is no contact between the rotors and the case, there is no wear and no lubrication is required. Oil is, however, required to lubricate the bearings and gears. The lack of contact means that some leakage occurs and the rate is directly related to the pressure differential between ports. As the pressure differential increases, the leakage rate increases.

Furthermore, as the leakage rate increases the adiabatic efficiency decreases, increasing the discharge temperature and power requirement.

The net flow rate and efficiency is then dependent upon the shaft speed, volume flow per revolution, and leakage rate at the operational pressure point.

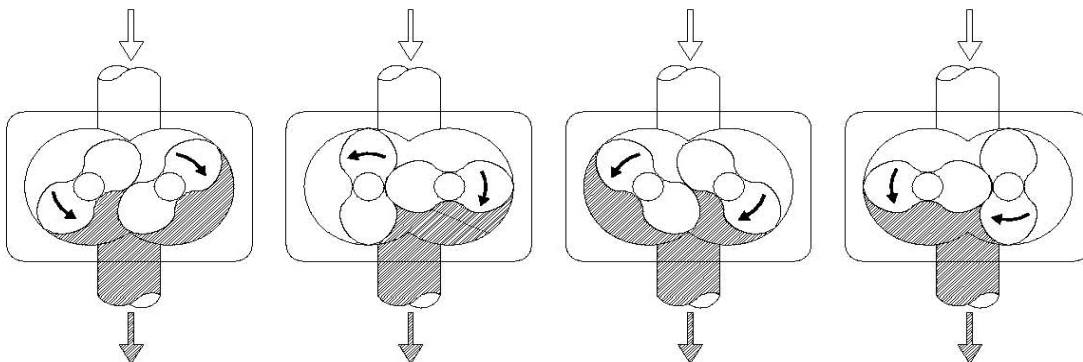



5.2 Construction

As described in operating characteristics 5.1, each blower is constructed for a specific volume flow rate per revolution and is defined by design and rotor length. The MB Series offers (11) eleven models to choose from. Each model offers a variety of flow rates by changing the rotational speed. (See technical specifications 1.1)

To maximize efficiency, materials and clearances are chosen to maintain minimal clearance with reliable operation up to a limiting pressure differential pressure. Exceeding this pressure can cause thermal overload. Each model, within the MB series, is capable of a different differential pressure. (See technical specifications 1.1)

Thermal overload is a point at which the blower cannot dissipate enough heat (thermal energy) to maintain design clearances due to thermal expansion and deformation.

The drive shaft, located on only one rotor, can be driven in one direction and is suitable for direct or belt driven. Directly coupling the motor to the driveshaft allows for maximum power transmission.

The integrated feet on all sides of the housing allow for a universal installation: in both vertical and horizontal configurations, the blower can be mounted from any side, top or bottom.

Eurus' standard rotary blowers can be used in both horizontal and vertical flow configurations.

5.3 Horizontal Flow Configuration

The drive shaft is located at the upper rotor (Direction of Rotation: CW)

Attention!

In the horizontal flow configuration, the rotary blower may only be operated with the input shaft located at the top.

If it is required to locate the drive shaft as the lower rotor in the horizontal flow configuration, Eurus Blower Engineering must be consulted first.

- See the following diagram for the positions of the oil level sight glasses and oil fill plugs.



- See chapter 1.3 for oil capacities.

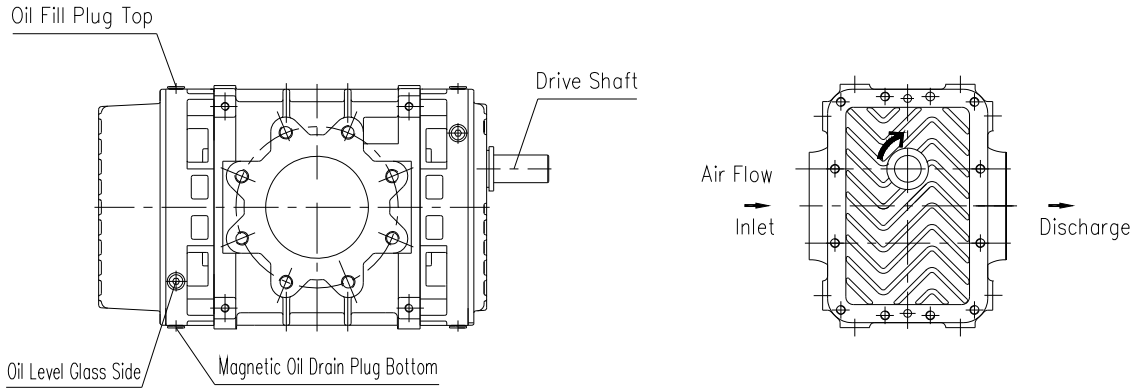

5.4 Vertical Flow Configuration

The drive shaft is located on the right (CW rotation) or optionally located on left of center (CCW Rotation)

- See the following diagram for the positions of the oil level sight glasses and oil fill plugs.
- See section 1.3 for oil capacities.

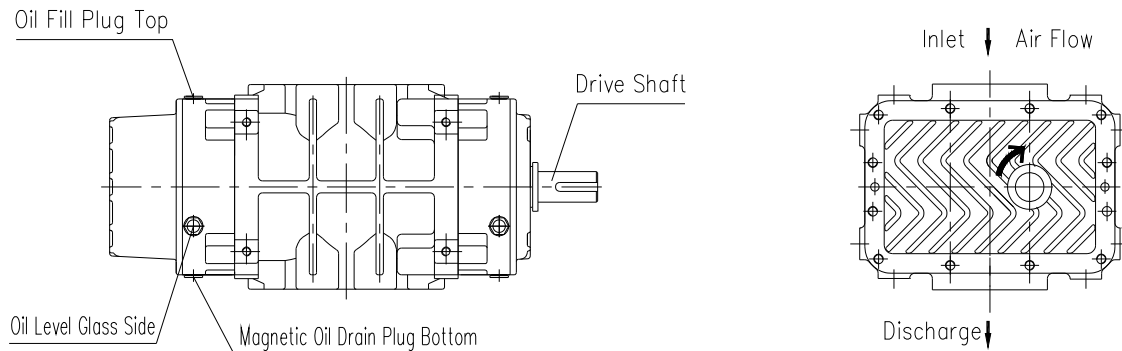



6. Installation and Design Requirements

6.1 Installation Requirements

Always operate rotary blowers in a dry and dust free environment.

Tapped holes are provided on all sides of case for mounting purposes

Attention!

Mount the rotary blower on a stable and flat base: uneven mounting can cause stress on the housing.

Leave the flanged ports blanked off until the piping can be installed on the inlet and outlet flanges to prevent foreign particles and/or contamination from entering the blower.

Be sure to support the weight of the pipe work, inlet and discharge silencers, and any other connected components that are attached to the rotary blower: Do not rely on the connections with rotary blower unit to support the weight of these various components.

To isolate vibrations, only flexible pipe connections can be used when connecting the rotary blower to the rest of the system.

Remove the port covers before connecting piping or accessories to the rotary blower.

Check the drive shaft for ease of rotation by hand after installation.

During installation of the rotary blower, checks that the oil level sight glass and the oil fill plugs are correctly located according to the intended configuration - change them if necessary (see Construction chapter 6.3, 6.4).

Observe temperature ratings for all system components connected to the rotary blower - especially the discharge flex union and the discharge silencer.

Please see the typical installation diagrams in the following sections.



6.1.1 Typical Blower (Positive Pressure) System Diagram

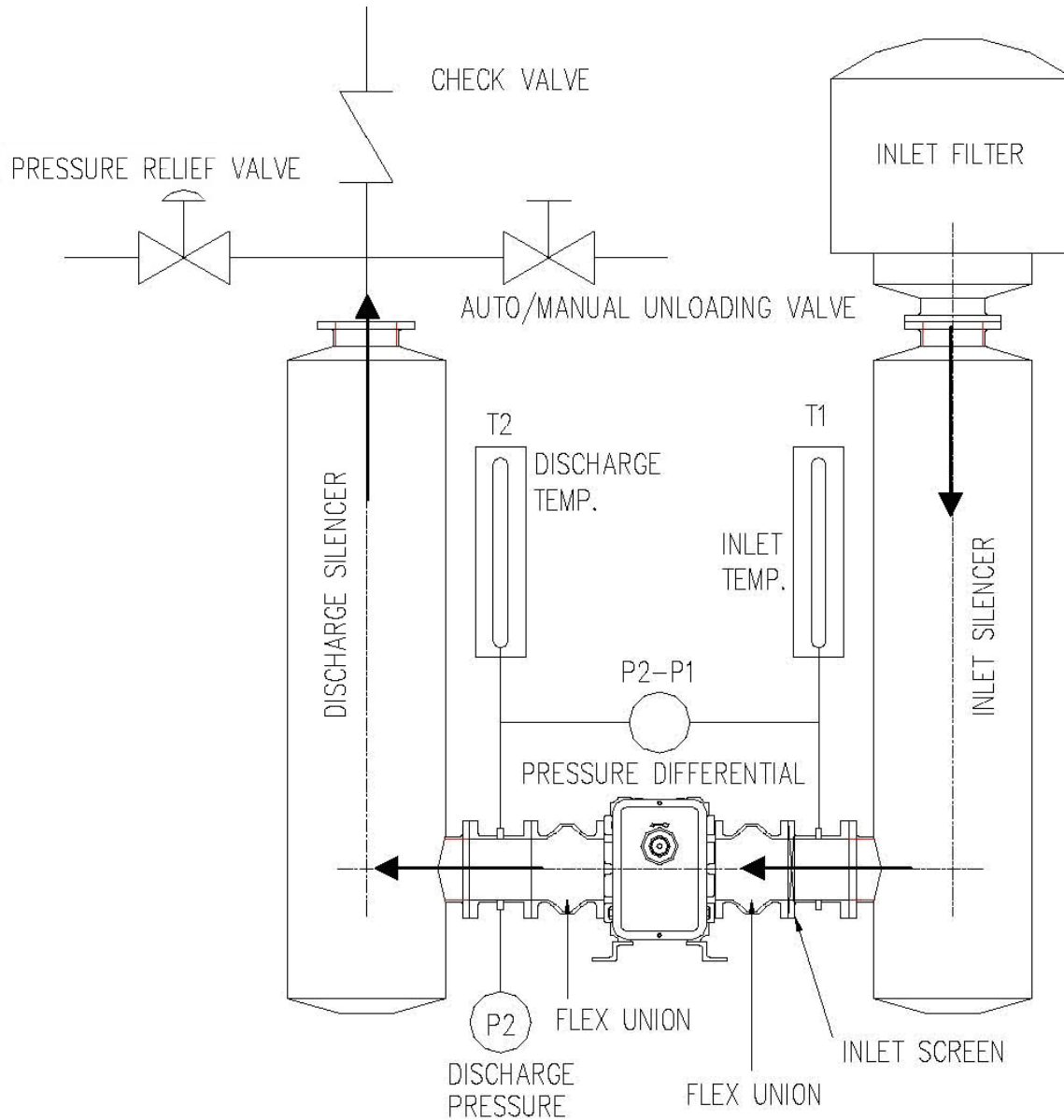

SILENCER SHOULD BE AT LEAST ONE PIPE DIAMETER AWAY FROM BLOWER FLANGE



6.1.2 Typical Vacuum / Exhaust (Negative Pressure) System Diagram

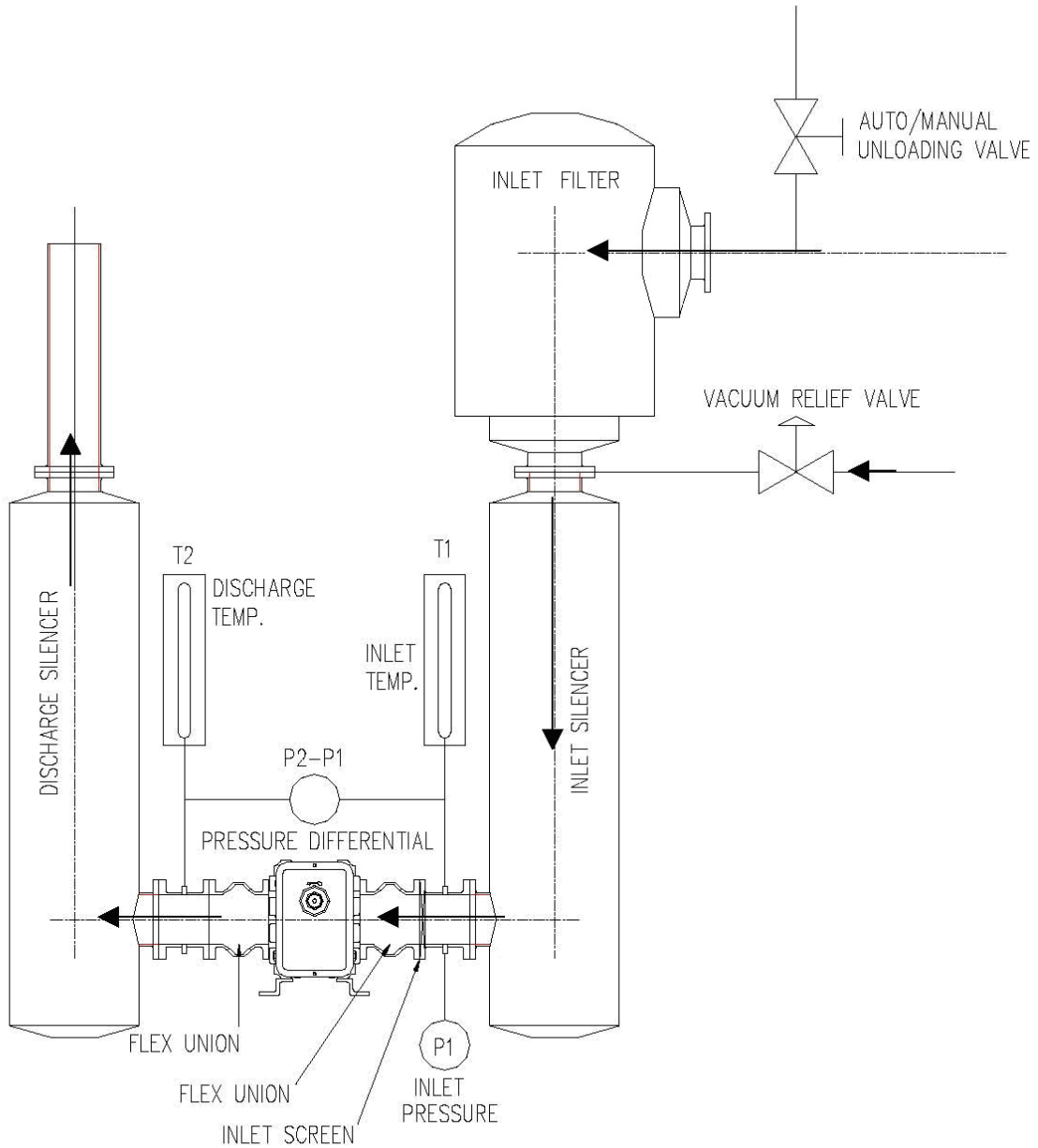

SILENCER SHOULD BE AT LEAST ONE PIPE DIAMETER AWAY FROM BLOWER FLANGE



6.2 Drive Motor

The rotary blower can be driven by all standard drive sources available on the market.

The rated power of the drive source should be greater than power requirements of blower. Consult industry standard information for their service factor recommendations. Typical minimum service factors are:

- Electric motor: 1.15
- Belt drive systems: 1.5
- Direct drive couplings: 1.4

The speed of the drive source must be selected or controlled such that the maximum permissible rotor speed cannot be exceeded (see chapter 1.1).

Drive system components must:

- Comply with speed ratings advised by their manufacturer;
- Be balanced to AGMA class 7 or better; and
- Be fitted to the two shafts with line to line up to 0.001” interference (heating of hubs to facilitate assembly is common practice).

Attention!

Protect bearings, belt pulleys and coupling hubs against impact damage. Do not strike these components: this may damage the shaft bearings.

For maximum radial shaft loading (see section 1.1)

Some axial loading of the drive shaft is permitted, but should be avoided. Static axial loads during assembly can be fully supported without damage. Dynamic (in operation) axial loading will, in some cases, decrease bearing life. If a known dynamic axial load (over 50 Lbs.) is transmitted by the drive source, consult Eurus Blower’s Engineering Department.

Always use the threaded holes at the end of the shafts for alignment when using a gear puller to remove any accessories or components on the shaft.

All drive system components should have a guard that protects people in the vicinity of the unit from the exposed rotating components. Be sure that the guard is selected and installed with regard to all safety regulations, including OSHA CFR 29, 1910. (see chapter 2).



6.2.1 Direct coupled drive with flexible coupling

To directly couple the motor to the input shaft with a flexible coupling:

- The drive and driven shafts must be accurately aligned and have a sufficient gap to minimize axial and radial forces;
- Maximum deviation in offset between drive and driven shaft centerline should not exceed 0.005" TIR (Total Indicated Runout) referenced from both hubs; and
- Maximum deviation from parallel off centerline or hub faces should not exceed 0.001" when checked at a minimum of four points around center.

6.2.2 V-belt drive

When using V-belts to connect the motor and rotary blower, consider the following:

- Misalignment of the V-belt drive should not exceed $\pm 0.5^\circ$ in both parallel and perpendicular planes.
- Use the largest sheave diameters permitted by speed rating to maximize power transfer through the V-belt (This is opposite to economically driven belt drive selection, resulting in small-underrated drives).
- Use belt lengths that keep the center distance between shafts more than 24" and less than 48".
- Larger center distances are used and favor longer belt life; however, the tendency for V-belts to vibrate at resonate frequencies should be reviewed.
- Shorter distances mean less misalignment forgiveness, shorter V-belt life, and low speed ratio selection (compact V-belt drives are common, but should be used on low power, low ratio, drive system with higher service factor rating, above 1.5).
- Check the tension of the V-belts and adjust, if necessary, when installing the unit.
- Manual tension adjustment systems need the V-belts checked for tension 30 minutes and 24 hours after every adjustment. Tension should not drift below values recommended by the belt manufacturer.
- Automatic tension adjustment systems need adjustment once prior to operation.



- Use of small V-belt cross section for high belt speeds is recommended.
- Avoid selection of V-belts that operate near their speed limit.

6.3 System Safety Equipment

Attention!

To ensure safe, automatic operation of the rotary blower the user must install safety control equipment like pressure relief valves.

6.3.1 Safety relief valve

A relief valve(s), pressure or vacuum, is necessary to prevent the rotary blower from operating above maximum pressure differential.

A vacuum relief valve should be located before the inlet port if there is any possibility of a blockage in flow to exist which would exceed the maximum pressure differential -especially blowers operating with negative inlet pressure.

A pressure relief valve should be located after the discharge port if any possibility of increased resistance exists to exceed maximum pressure differential - especial blowers operating with positive discharge pressures.

Be sure that pressure relief valves are rated for temperatures above the discharge temperatures expected during operation.

Set Point

The set point on the relief valve must correspond to the designed operating pressures and the range of conditions under which the unit will operate.

Attention!

A pressure relief valve is necessary to be sure that the unit never exceeds its maximum pressure difference by no more than 1 psi – positive pressure or vacuum. This includes full blow- off condition.

The required relief valve flow rate should be equivalent to the maximum flow delivered by the rotary blower under those inlet and discharge conditions.

The limiting values defined in chapter 1.1 must be observed.



6.3.2 Check valve

A check valve is necessary to prevent a reversal of flow whenever the rotary blower starts and stops.

Attention!

The sizing of the check valve should be rated for the maximum flow rate and the maximum operating pressure differential.

The check valve must:

- Be located after the discharge port for positive pressure (at the inlet port for vacuum); and
- Be rated for temperatures above expected discharge temperatures during operation.

6.3.3 Visual Indicators of Temperature and Pressure

Good systems employ local display of the temperature, pressure or vacuum.

Attention!

Location of measurement devices should be at or near the port openings of rotary blower.

Limits should be displayed on visual indicators for quick assessment of the operating condition.

6.3.4 Monitoring Device switches

For safest operation, the operating parameters (temperature and differential pressure) of the unit should be continuously monitored to be sure that they are within the limits set by the manufacturer.

Attention!

The most important parameter to monitor is discharge temperature.



Because it may take a gauge some time to respond to a change in temperature, sensitive applications should directly monitor the pressure differential.

When a parameter falls out of its limits, corrective action should be quickly initiated to reduce the air resistance or reduce the rotational speed of the rotary blower.

For best results, the measuring devices should trigger the motor controls to immediately shutdown the motor.

6.3.5 Noise reduction

Attention!

The use of inlet and discharge silencers is highly recommended.

Most designs incorporate some means of noise reduction. Here are a few points on reducing noise:

- Choose chamber type silencers if rotary blower speed is below 2,250 rpm.
- Choose absorption/chamber combination silencer when operating rotary blower above 2,250 rpm.
- Use large silencer volumes in excess of 15 times volume flow per revolution to minimize pulsations.
- Use silencers that attenuate peak frequencies equivalent to $0.06 \times \text{RPM}$.
- Discharge silencers must be rated for temperatures above expected discharge temperatures during operation.
- Sound enclosures are required to achieve lower noise levels, contact Eurus Blower for further information
- Sound enclosures must have adequately ventilated to maintain normal ambient operating temperatures.



7. Operating a Rotary Blower

7.1 Prior to Starting Unit for First Time

Every rotary blower undergoes a mechanical run test at maximum pressure prior to leaving the factory. During the test, key indicators, such as vibration and temperature, are monitored for unit quality ensuring conformity to specifications.

It is expected that the user employs safe working practices, and that all lawful operating and safety regulations are followed when operating this rotary blower.

Attention!

The user carries full responsibility for the installation of the rotary blower and the safety equipment required for safe operation.

Do not operate this rotary blower in spaces where heavy dust conditions, poisonous or corrosive gasses could exist.

The installation and operating procedures for all ancillary equipment must be observed.

When starting the unit for the first time, do the following:

- Carry out a check of all safety and monitoring equipment.
- Check the oil level and top up if necessary (see chapter 8.3)
- Check the direction of rotation of the rotary blower.
- Start with little air resistance and gradually increase.
- Take time to learn the operational characteristics and unit controls before full duty service.



7.2 Starting and Stopping the Rotary Blower

The rotary blower itself can be stopped and started repeatedly; however, most drive systems should not be subjected to repeated starts and stops. Doing this without increased service factors for all components may decrease the service life of these components.

After stopping the rotary blower, always wait for full stop before restarting.

Avoid current inrush to drive source: use starters that allow gradual speed control. Start rotary blower under low load condition if possible.

If possible allow the rotary blower to operate at reduced load for 5-10 minutes prior to shutdown to reduce the blower temperature.

7.3 Troubleshooting

If there is a problem with the operation of the unit, consult the following table.

Be sure to note the actions and events that occurred prior to the problem.

Also, record any instrument readings that may be available.

Attention!

All general safety procedures and regulations must be observed while diagnosing and correcting any problems.



7.3.1 Trouble Shooting Guide

Trouble Shooting Guide, 7.3.1			
<p>The rotary blower is designed to provide dependable, low maintenance, trouble free performance. If you are experiencing a startup or operational problem, the guide below may help you determine the cause. If you require technical assistance, you may call the factory during normal business hours, TEL NO.: 757-538-1717</p>	Water in oil	<input type="checkbox"/>	<input type="checkbox"/>
	Low oil level	<input type="checkbox"/>	<input type="checkbox"/>
	High oil level	<input type="checkbox"/>	<input type="checkbox"/>
	High drive belt tension	<input type="checkbox"/>	<input type="checkbox"/>
	Ridged flange mounting	<input type="checkbox"/>	<input type="checkbox"/>
	Drive runout and balance	<input type="checkbox"/>	<input type="checkbox"/>
	Base flatness & rigidity	<input type="checkbox"/>	<input type="checkbox"/>
	Bearings	<input type="checkbox"/>	<input type="checkbox"/>
	Gear backlash	<input type="checkbox"/>	<input type="checkbox"/>
	Rotor contact	<input type="checkbox"/>	<input type="checkbox"/>
	Damaged seal	<input type="checkbox"/>	<input type="checkbox"/>
	Low voltage	<input type="checkbox"/>	<input type="checkbox"/>
	Motor starter	<input type="checkbox"/>	<input type="checkbox"/>
	Rotor inertia	<input type="checkbox"/>	<input type="checkbox"/>
	Rotational direction	<input type="checkbox"/>	<input checked="" type="checkbox"/>
	High RPM	<input type="checkbox"/>	<input type="checkbox"/>
	Low RPM	<input type="checkbox"/>	<input checked="" type="checkbox"/>
	Low slip	<input type="checkbox"/>	<input checked="" type="checkbox"/>
	High inlet temperature	<input type="checkbox"/>	<input type="checkbox"/>
	Low inlet temperature	<input type="checkbox"/>	<input type="checkbox"/>
	High inlet resistance	<input type="checkbox"/>	<input checked="" type="checkbox"/>
	Low inlet resistance	<input type="checkbox"/>	<input type="checkbox"/>
	High discharge resistance	<input type="checkbox"/>	<input checked="" type="checkbox"/>
	Low discharge resistance	<input checked="" type="checkbox"/>	<input type="checkbox"/>
	Possible Causes		
	Symptoms		
Blower Application			
Low pressure, High flow	<input type="checkbox"/>	<input type="checkbox"/>	
Low pressure, Low flow	<input type="checkbox"/>	<input type="checkbox"/>	
High pressure, Low flow	<input type="checkbox"/>	<input type="checkbox"/>	
High pressure, High flow	<input type="checkbox"/>	<input type="checkbox"/>	
Vacuum Applications			
Low vacuum, High flow	<input type="checkbox"/>	<input type="checkbox"/>	
Low vacuum, Low flow	<input type="checkbox"/>	<input type="checkbox"/>	
High vacuum, Low flow	<input type="checkbox"/>	<input type="checkbox"/>	
High vacuum, High flow	<input type="checkbox"/>	<input type="checkbox"/>	
General Applications			
High discharge temperature	<input type="checkbox"/>	<input type="checkbox"/>	
High Bhp, High Amps	<input type="checkbox"/>	<input type="checkbox"/>	
Amp break trips on startup	<input type="checkbox"/>	<input type="checkbox"/>	
Abnormal noise	<input type="checkbox"/>	<input type="checkbox"/>	
High vibration	<input type="checkbox"/>	<input type="checkbox"/>	
Premature bearing failure	<input type="checkbox"/>	<input type="checkbox"/>	
Oil leak	<input type="checkbox"/>	<input type="checkbox"/>	



8. Maintenance

8.1 Rules for maintenance

Attention!	Always ensure that personnel protective measures are taken according to the accident prevention regulations.
-------------------	---

Observe the following rules during all maintenance and service work:

- **Only specially trained personnel should perform work on power driven equipment;**
- **Stop the blower;**
- **Lock out and tag out the main disconnect switch to prevent restarting;**
- **Isolate and de-pressurize the blower and attached piping to zero psig.**

See section 7 for blower operation, starting and stopping.

	Ensure that all oil, solvents and used parts are disposed of according to federal and local environmental regulations.
--	---

8.2 Regular Maintenance Schedule

Period	Work to be done
1-24 hours after 1 st startup	Check oil level frequently; Check belt tension Record baseline data
100-200 hours after 1 st startup	Change lubricating oil
Monthly	Check oil level*
1,500-2,000 hours*	Change oil (mineral)
6,000-8,000 hours*	Change oil (synthetic)

* The maintenance period can vary depending on the service and environmental conditions.



The oil should be changed at least once a year, even if the blower is not operated. Record maintenance work done (see section 10).

8.3 Oil level check

8.3.1 Oil Sight Glasses

Warning!	Attention!	<ul style="list-style-type: none">• The lubricating oil, rotary blower casing and attached parts can become extremely hot.• The oil chambers of the gear and drive ends are not connected to each other: be sure to check the level in both chambers.
 Hot Surface Do Not Touch!		

Stop the rotary blower before checking the oil level. Use the sight glasses to determine the oil level as instructed below.

Check oil level on both sides of each end as the rotary blower can be off level. An oil level 1/4" below the center line is in DANGER of failure; an oil level 1/8" below the centerline indicated the oil level is low.

Note: Oil level should be between the center line and 1/8" above center line; if the oil level is more than 1/4" above the centerline, there is a risk of oil leakage.

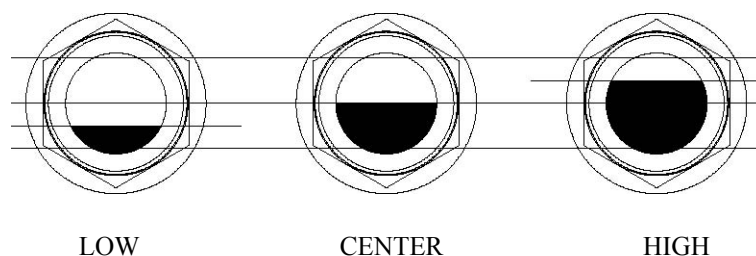

Oil level sight glass



To check the lubricating oil level:

1. Stop the rotary blower (see chapter 8);
2. Check the lubrication oil level at all oil level sight glasses.

To initially fill the lubricating oil:

1. Stop the rotary blower (see chapter 8.1) and lock-out the power source to prevent a restart;
2. Unscrew the fill plug on top of the unit;
3. Pour the indicated amount of oil into the port and look at the new oil level in the sight glasses;
4. Fill with lubricating oil to the correct height;
5. Fill both ends (drive and gear side);
6. Screw the oil fill plug marked red in again;
7. Check for leaks.

8.4 Changing the Oil

Change the oil when the following situations occur:

- Change oil after approximately 150 hours of the first time in service;
- Change oil after approximately 1,500 –2,500 service hours for mineral lubricants approximately 6,000-8,000 service hours for synthetic lubricants;
- Change at least once annually.

To change the lubricating oil:

- Stop the rotary blower (see chapter 8.1 and lock out the power to prevent a restart.)

Attention!	To avoid the dangers of burning by hot components, wait until the rotary blower has cooled down to below 140°F.
-------------------	--

- Change oil when the oil is warm, above approximately 130°F.
- Place a container ready to catch the used oil (see section 1.3 for the oil capacity)
- **The used oil must be collected and disposed of according to all federal and local environmental regulations.**
- Drain the oil by unscrewing the oil drain plug in the bottom of the casing; open the corresponding oil fill plug on top to speed oil flow.
- Clean the magnetic oil drain plug and screw back into the port.
- Fill unit with new lubricating oil.
- Screw the oil fill plug back into the port.
- Visually check for leaks.



9. Spare Parts and After Sales Service

9.1 General Exploded Parts Diagram

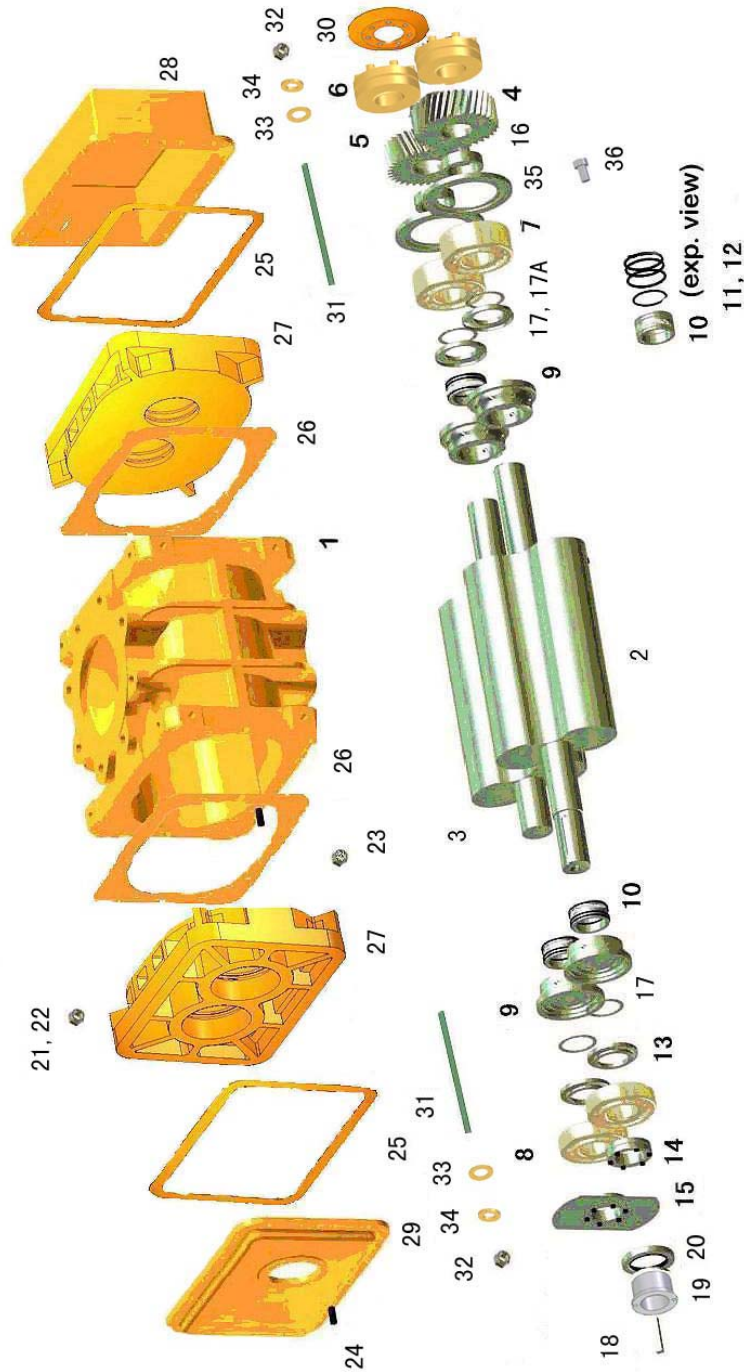



Model: MB3004 Parts List

All Configurations

<i>ITEM</i>	<i>QTY</i>	<i>PART NUMBER</i>	<i>DESCRIPTION</i>	<i>MATERIAL</i>
1	1	MB3004-0101	Impeller Case	Gray Iron
2	1	MB3004-0500	Drive Rotor	Ductile Iron
3	1	MB3004-0600	Driven Rotor	Ductile Iron
4	1	ZG-1102-50	Drive Helical Gear	Alloy Steel
5	1	ZG-1101-50	Driven Helical Gear	Alloy Steel
6	2	MB30101	Locking Assembly (Z7B 36X72)	Steel
7	2	MB30102	Ball Bearing (6306)	Steel
8	2	MB30103	Roller Bearing (NJ306E/C3)	Steel
9	4	ZG-1012-50	Ring Seal Stator Insert	Gray Iron
10	4	ZG-1011A-50	Ring Seal Rotor Sleeve	Steel
11	5	MB30104	O-Ring (30 X 2.65) (IDXCS)	Viton
12	12	ZG-1013-50	Piston Ring	Alloy Iron
13	4	ZG-1106A-50	Oil Slinger	Steel
14	1	ZG-50-SJT	Lock Sleeve Assembly	Steel
15	1	ZG-50-SYP	Oil Flinger Assembly	Steel
16	2	ZG-1108-50	Gear Spacer	Steel
17	8	ZG-1202-50	Bearing Shim (0.5, 0.2mm)	Steel
17A	8	ZG-1202-50	Bearing Shim (0.1, 0.05mm)	Steel
18	1	MB30105	Key (C8X63)	Steel
19	1	ZG-1021-50	Wear Ring	Steel
20	1	MB30106	Lip Seal (45X65X7)	Viton
21	4	MB30107	Plug (M16X1.5)	Steel
22	2	MB30108	Magnetic Plug (M16X1.5)	Steel
23	2	MB30109	Sight Glass (M16X1.5)	Steel
24	6	MB30111	Dowel Pin (B8X28)	Steel
25	2	ZG-1205A-50	Cover Gasket	
26	1	ZG-1201-50	Cylinder Shim (0.1mm)	Fish paper
27	2	ZG-0201A-50	Endplate	Gray Iron
28	1	ZG-0311A-50	Gear Oil Cover	Aluminum
29	1	ZG-0411A-50	Drive Side Oil Cover	Aluminum
30	N/A	N/A	N/A	N/A
31	24	MB30113	Stud Bolt (M8X90)	Steel
32	24	MB30114	Nut (M8)	Steel
33	24	MB30115	Washer 8	Steel
34	24	MB30116	Lock Washer 8	Alloy Steel
35	2	ZG-0202-50	Bearing Clamp Plate	Steel
36	8	MB30112	Socket Head Screw M6X12	Steel



Model: MB3006 Parts List

All Configurations

<i>ITEM</i>	<i>QTY</i>	<i>PART NUMBER</i>	<i>DESCRIPTION</i>	<i>MATERIAL</i>
1	1	MB3006-0101	Impeller Case	Gray Iron
2	1	MB3006-0500	Drive Rotor	Ductile Iron
3	1	MB3006-0600	Driven Rotor	Ductile Iron
4	1	ZG-1102-50	Drive Helical Gear	Alloy Steel
5	1	ZG-1101-50	Driven Helical Gear	Alloy Steel
6	2	MB30101	Locking Assembly (Z7B 36X72)	Steel
7	2	MB30102	Ball Bearing (6306)	Steel
8	2	MB30103	Roller Bearing (NJ306E/C3)	Steel
9	4	ZG-1012-50	Ring Seal Stator Insert	Gray Iron
10	4	ZG-1011A-50	Ring Seal Rotor Sleeve	Steel
11	5	MB30104	O-Ring (30 X 2.65) (IDXCS)	Viton
12	12	ZG-1013-50	Piston Ring	Alloy Iron
13	4	ZG-1106A-50	Oil Slinger	Steel
14	1	ZG-50-SJT	Lock Sleeve Assembly	Steel
15	1	ZG-50-SYP	Oil Flinger Assembly	Steel
16	2	ZG-1108-50	Gear Spacer	Steel
17	8	ZG-1202-50	Bearing Shim (0.5, 0.2mm)	Steel
17A	8	ZG-1202-50	Bearing Shim (0.1, 0.05mm)	Steel
18	1	MB30105	Key (C8X63)	Steel
19	1	ZG-1021-50	Wear Ring	Steel
20	1	MB30106	Lip Seal (45X65X7)	Viton
21	4	MB30107	Plug (M16X1.5)	Steel
22	2	MB30108	Magnetic Plug (M16X1.5)	Steel
23	2	MB30109	Sight Glass (M16X1.5)	Steel
24	6	MB30111	Dowel Pin (B8X28)	Steel
25	2	ZG-1205A-50	Cover Gasket	
26	1	ZG-1201-50	Cylinder Shim (0.1mm)	Fish paper
27	2	ZG-0201A-50	Endplate	Gray Iron
28	1	ZG-0311A-50	Gear Oil Cover	Aluminum
29	1	ZG-0411A-50	Drive Side Oil Cover	Aluminum
30	N/A	N/A	N/A	N/A
31	24	MB30113	Stud Bolt (M8X90)	Steel
32	24	MB30114	Nut (M8)	Steel
33	24	MB30115	Washer 8	Steel
34	24	MB30116	Lock Washer 8	Alloy Steel
35	2	ZG-0202-50	Bearing Clamp Plate	Steel
36	8	MB30112	Socket Head Screw M6X12	Steel



Model: MB3007 Parts List

All Configurations

<i>ITEM</i>	<i>QTY</i>	<i>PART NUMBER</i>	<i>DESCRIPTION</i>	<i>MATERIAL</i>
1	1	MB3007-0101	Impeller Case	Gray Iron
2	1	MB3007-0500	Drive Rotor	Ductile Iron
3	1	MB3007-0600	Driven Rotor	Ductile Iron
4	1	ZG-1102-50	Drive Helical Gear	Alloy Steel
5	1	ZG-1101-50	Driven Helical Gear	Alloy Steel
6	2	MB30101	Locking Assembly (Z7B 36X72)	Steel
7	2	MB30102	Ball Bearing (6306)	Steel
8	2	MB30103	Roller Bearing (NJ306E/C3)	Steel
9	4	ZG-1012-50	Ring Seal Stator Insert	Gray Iron
10	4	ZG-1011A-50	Ring Seal Rotor Sleeve	Steel
11	5	MB30104	O-Ring (30 X 2.65) (IDXCS)	Viton
12	12	ZG-1013-50	Piston Ring	Alloy Iron
13	4	ZG-1106A-50	Oil Slinger	Steel
14	1	ZG-50-SJT	Lock Sleeve Assembly	Steel
15	1	ZG-50-SYP	Oil Flinger Assembly	Steel
16	2	ZG-1108-50	Gear Spacer	Steel
17	8	ZG-1202-50	Bearing Shim (0.5, 0.2mm)	Steel
17A	8	ZG-1202-50	Bearing Shim (0.1, 0.05mm)	Steel
18	1	MB30105	Key (C8X63)	Steel
19	1	ZG-1021-50	Wear Ring	Steel
20	1	MB30106	Lip Seal (45X65X7)	Viton
21	4	MB30107	Plug (M16X1.5)	Steel
22	2	MB30108	Magnetic Plug (M16X1.5)	Steel
23	2	MB30109	Sight Glass (M16X1.5)	Steel
24	6	MB30111	Dowel Pin (B8X28)	Steel
25	2	ZG-1205A-50	Cover Gasket	
26	1	ZG-1201-50	Cylinder Shim (0.1mm)	Fish paper
27	2	ZG-0201A-50	Endplate	Gray Iron
28	1	ZG-0311A-50	Gear Oil Cover	Aluminum
29	1	ZG-0411A-50	Drive Side Oil Cover	Aluminum
30	N/A	N/A	N/A	N/A
31	24	MB30113	Stud Bolt (M8X90)	Steel
32	24	MB30114	Nut (M8)	Steel
33	24	MB30115	Washer 8	Steel
34	24	MB30116	Lock Washer 8	Alloy Steel
35	2	ZG-0202-50	Bearing Clamp Plate	Steel
36	8	MB30112	Socket Head Screw M6X12	Steel



Model: MB4504 Parts List

All Configurations

<i>ITEM</i>	<i>QTY</i>	<i>PART NUMBER</i>	<i>DESCRIPTION</i>	<i>MATERIAL</i>
1	1	M4504-0101	Impeller Case	Gray Iron
2	1	M4504-0500	Drive Rotor	Ductile Iron
3	1	M4504-0600	Driven Rotor	Ductile Iron
4	1	M45-1102	Drive Helical Gear	Alloy Steel
5	1	M45-1101	Driven Helical Gear	Alloy Steel
6	2	MB45101	Locking Assembly (Z7B 55X100)	Steel
7	2	MB45102	Angular Contact Ball Bearing (3309)	Steel
8	2	MB45103	Roller Bearing, (NJ309E/C3)	Steel
9	4	M45-1012A	Ring Seal Stator Insert	Gray Iron
10	4	M45-1011B	Ring Seal Rotor Sleeve	Steel
11	5	MB45104	O-Ring (45 X 2.65) (IDXCS)	Viton
12	12	M45-1013	Piston Ring	Alloy Iron
13	4	M45-1106B	Oil Slinger	Steel
14	1	M45-SJT	Lock Sleeve Assembly	Steel
15	1	M45-SYP	Oil Flinger Assembly	Steel
16	2	M45-1108	Gear Spacer	Steel
17	8	M45-1202A	Bearing Shim (0.5, 0.2mm)	Steel
17A	8	M45-1202A	Bearing Shim (0.1, 0.05mm)	Steel
18	1	MB45105	Key (C12 X 70)	Steel
19	1	M45-1021B	Wear Ring,	Steel
20	1	MB45106	Lip Seal (55 X 75X8)	Viton
21	4	MB45107	Plug (M20 X 1.5)	Steel
22	2	MB45108	Plug Magnetic (M20 X 1.5)	Steel
23	2	MB45109	Sight Glass (M20 X 1.5)	Steel
24	6	MB45111	Dowel Pin (B12 X 40)	Steel
25	2	M45-1205A	Cover Gasket	
26	1	M45-1201A	Cylinder Shim (0.1mm)	Fish paper
27	2	M45-0201B	Endplate	Gray Iron
28	1	M45-0311A	Gear Oil Cover	Aluminum
29	1	M45-0411A	Drive Side Oil Cover	Aluminum
30	1	M45-1107A	Oil Flinger (Gear Side)	Steel
31	24	MB45113	Stud Bolt (M10X110)	Steel
32	24	MB45114	Nut (M10)	Steel
33	24	MB45115	Washer 10	Steel
34	24	MB45116	Lock Washer 10	Alloy Steel
35	2	M45-0202	Bearing Clamp Plate	Steel
36	8	MB45112	Socket Head Screw (M8 X 12)	Steel



Model: MB4506 Parts List

All Configurations

<i>ITEM</i>	<i>QTY</i>	<i>PART NUMBER</i>	<i>DESCRIPTION</i>	<i>MATERIAL</i>
1	1	M4506-0101	Impeller Case	Gray Iron
2	1	M4506-0500	Drive Rotor	Ductile Iron
3	1	M4506-0600	Driven Rotor	Ductile Iron
4	1	M45-1102	Drive Helical Gear	Alloy Steel
5	1	M45-1101	Driven Helical Gear	Alloy Steel
6	2	MB45101	Locking Assembly (Z7B 55X100)	Steel
7	2	MB45102	Angular Contact Ball Bearing (3309)	Steel
8	2	MB45103	Roller Bearing, (NJ309E/C3)	Steel
9	4	M45-1012A	Ring Seal Stator Insert	Gray Iron
10	4	M45-1011B	Ring Seal Rotor Sleeve	Steel
11	5	MB45104	O-Ring (45 X 2.65) (IDXCS)	Viton
12	12	M45-1013	Piston Ring	Alloy Iron
13	4	M45-1106B	Oil Slinger	Steel
14	1	M45-SJT	Lock Sleeve Assembly	Steel
15	1	M45-SYP	Oil Flinger Assembly	Steel
16	2	M45-1108	Gear Spacer	Steel
17	8	M45-1202A	Bearing Shim (0.5, 0.2mm)	Steel
17A	8	M45-1202A	Bearing Shim (0.1, 0.05mm)	Steel
18	1	MB45105	Key (C12 X 70)	Steel
19	1	M45-1021B	Wear Ring,	Steel
20	1	MB45106	Lip Seal (55 X 75X8)	Viton
21	4	MB45107	Plug (M20 X 1.5)	Steel
22	2	MB45108	Plug Magnetic (M20 X 1.5)	Steel
23	2	MB45109	Sight Glass (M20 X 1.5)	Steel
24	6	MB45111	Dowel Pin (B12 X 40)	Steel
25	2	M45-1205A	Cover Gasket	
26	1	M45-1201A	Cylinder Shim (0.1mm)	Fish paper
27	2	M45-0201B	Endplate	Gray Iron
28	1	M45-0311A	Gear Oil Cover	Aluminum
29	1	M45-0411A	Drive Side Oil Cover	Aluminum
30	1	M45-1107A	Oil Flinger (Gear Side)	Steel
31	24	MB45113	Stud Bolt (M10X110)	Steel
32	24	MB45114	Nut (M10)	Steel
33	24	MB45115	Washer 10	Steel
34	24	MB45116	Lock Washer 10	Alloy Steel
35	2	M45-0202	Bearing Clamp Plate	Steel
36	8	MB45112	Socket Head Screw (M8 X 12)	Steel



Model: MB4509 Parts List

All Configurations

<i>ITEM</i>	<i>QTY</i>	<i>PART NUMBER</i>	<i>DESCRIPTION</i>	<i>MATERIAL</i>
1	1	M4509-0101	Impeller Case	Gray Iron
2	1	M4509-0500	Drive Rotor	Ductile Iron
3	1	M4509-0600	Driven Rotor	Ductile Iron
4	1	M45-1102	Drive Helical Gear	Alloy Steel
5	1	M45-1101	Driven Helical Gear	Alloy Steel
6	2	MB45101	Locking Assembly (Z7B 55X100)	Steel
7	2	MB45102	Angular Contact Ball Bearing (3309)	Steel
8	2	MB45103	Roller Bearing, (NJ309E/C3)	Steel
9	4	M45-1012A	Ring Seal Stator Insert	Gray Iron
10	4	M45-1011B	Ring Seal Rotor Sleeve	Steel
11	5	MB45104	O-Ring (45 X 2.65) (IDXCS)	Viton
12	12	M45-1013	Piston Ring	Alloy Iron
13	4	M45-1106B	Oil Slinger	Steel
14	1	M45-SJT	Lock Sleeve Assembly	Steel
15	1	M45-SYP	Oil Flinger Assembly	Steel
16	2	M45-1108	Gear Spacer	Steel
17	8	M45-1202A	Bearing Shim (0.5, 0.2mm)	Steel
17A	8	M45-1202A	Bearing Shim (0.1, 0.05mm)	Steel
18	1	MB45105	Key (C12 X 70)	Steel
19	1	M45-1021B	Wear Ring,	Steel
20	1	MB45106	Lip Seal (55 X 75X8)	Viton
21	4	MB45107	Plug (M20 X 1.5)	Steel
22	2	MB45108	Plug Magnetic (M20 X 1.5)	Steel
23	2	MB45109	Sight Glass (M20 X 1.5)	Steel
24	6	MB45111	Dowel Pin (B12 X 40)	Steel
25	2	M45-1205A	Cover Gasket	
26	1	M45-1201A	Cylinder Shim (0.1mm)	Fish paper
27	2	M45-0201B	Endplate	Gray Iron
28	1	M45-0311A	Gear Oil Cover	Aluminum
29	1	M45-0411A	Drive Side Oil Cover	Aluminum
30	1	M45-1107A	Oil Flinger (Gear Side)	Steel
31	24	MB45113	Stud Bolt (M10X110)	Steel
32	24	MB45114	Nut (M10)	Steel
33	24	MB45115	Washer 10	Steel
34	24	MB45116	Lock Washer 10	Alloy Steel
35	2	M45-0202	Bearing Clamp Plate	Steel
36	8	MB45112	Socket Head Screw (M8 X 12)	Steel



Model: MB4512 Parts List

All Configurations

<i>ITEM</i>	<i>QTY</i>	<i>PART NUMBER</i>	<i>DESCRIPTION</i>	<i>MATERIAL</i>
1	1	M4512-0101	Impeller Case	Gray Iron
2	1	M4512-0500	Drive Rotor	Ductile Iron
3	1	M4512-0600	Driven Rotor	Ductile Iron
4	1	M45-1102	Drive Helical Gear	Alloy Steel
5	1	M45-1101	Driven Helical Gear	Alloy Steel
6	2	MB45101	Locking Assembly (Z7B 55X100)	Steel
7	2	MB45102	Angular Contact Ball Bearing (3309)	Steel
8	2	MB45103	Roller Bearing, (NJ309E/C3)	Steel
9	4	M45-1012A	Ring Seal Stator Insert	Gray Iron
10	4	M45-1011B	Ring Seal Rotor Sleeve	Steel
11	5	MB45104	O-Ring (45 X 2.65) (IDXCS)	Viton
12	12	M45-1013	Piston Ring	Alloy Iron
13	4	M45-1106B	Oil Slinger	Steel
14	1	M45-SJT	Lock Sleeve Assembly	Steel
15	1	M45-SYP	Oil Flinger Assembly	Steel
16	2	M45-1108	Gear Spacer	Steel
17	8	M45-1202A	Bearing Shim (0.5, 0.2mm)	Steel
17A	8	M45-1202A	Bearing Shim (0.1, 0.05mm)	Steel
18	1	MB45105	Key (C12 X 70)	Steel
19	1	M45-1021B	Wear Ring,	Steel
20	1	MB45106	Lip Seal (55 X 75X8)	Viton
21	4	MB45107	Plug (M20 X 1.5)	Steel
22	2	MB45108	Plug Magnetic (M20 X 1.5)	Steel
23	2	MB45109	Sight Glass (M20 X 1.5)	Steel
24	6	MB45111	Dowel Pin (B12 X 40)	Steel
25	2	M45-1205A	Cover Gasket	
26	1	M45-1201A	Cylinder Shim (0.1mm)	Fish paper
27	2	M45-0201B	Endplate	Gray Iron
28	1	M45-0311A	Gear Oil Cover	Aluminum
29	1	M45-0411A	Drive Side Oil Cover	Aluminum
30	1	M45-1107A	Oil Flinger (Gear Side)	Steel
31	24	MB45113	Stud Bolt (M10X110)	Steel
32	24	MB45114	Nut (M10)	Steel
33	24	MB45115	Washer 10	Steel
34	24	MB45116	Lock Washer 10	Alloy Steel
35	2	M45-0202	Bearing Clamp Plate	Steel
36	8	MB45112	Socket Head Screw (M8 X 12)	Steel



Model: MB4518 Parts List

All Configurations

<i>ITEM</i>	<i>QTY</i>	<i>PART NUMBER</i>	<i>DESCRIPTION</i>	<i>MATERIAL</i>
1	1	M4518-0101	Impeller Case	Gray Iron
2	1	M4518-0500	Drive Rotor	Ductile Iron
3	1	M4518-0600	Driven Rotor	Ductile Iron
4	1	M45-1102	Drive Helical Gear	Alloy Steel
5	1	M45-1101	Driven Helical Gear	Alloy Steel
6	2	MB45101	Locking Assembly (Z7B 55X100)	Steel
7	2	MB45102	Angular Contact Ball Bearing (3309)	Steel
8	2	MB45103	Roller Bearing, (NJ309E/C3)	Steel
9	4	M45-1012A	Ring Seal Stator Insert	Gray Iron
10	4	M45-1011B	Ring Seal Rotor Sleeve	Steel
11	5	MB45104	O-Ring (45 X 2.65) (IDXCS)	Viton
12	12	M45-1013	Piston Ring	Alloy Iron
13	4	M45-1106B	Oil Slinger	Steel
14	1	M45-SJT	Lock Sleeve Assembly	Steel
15	1	M45-SYP	Oil Flinger Assembly	Steel
16	2	M45-1108	Gear Spacer	Steel
17	8	M45-1202A	Bearing Shim (0.5, 0.2mm)	Steel
17A	8	M45-1202A	Bearing Shim (0.1, 0.05mm)	Steel
18	1	MB45105	Key (C12 X 70)	Steel
19	1	M45-1021B	Wear Ring,	Steel
20	1	MB45106	Lip Seal (55 X 75X8)	Viton
21	4	MB45107	Plug (M20 X 1.5)	Steel
22	2	MB45108	Plug Magnetic (M20 X 1.5)	Steel
23	2	MB45109	Sight Glass (M20 X 1.5)	Steel
24	6	MB45111	Dowel Pin (B12 X 40)	Steel
25	2	M45-1205A	Cover Gasket	
26	1	M45-1201A	Cylinder Shim (0.1mm)	Fish paper
27	2	M45-0201B	Endplate	Gray Iron
28	1	M45-0311A	Gear Oil Cover	Aluminum
29	1	M45-0411A	Drive Side Oil Cover	Aluminum
30	1	M45-1107A	Oil Flinger (Gear Side)	Steel
31	24	MB45113	Stud Bolt (M10X110)	Steel
32	24	MB45114	Nut (M10)	Steel
33	24	MB45115	Washer 10	Steel
34	24	MB45116	Lock Washer 10	Alloy Steel
35	2	M45-0202	Bearing Clamp Plate	Steel
36	8	MB45112	Socket Head Screw (M8 X 12)	Steel



Model: MB6010 Parts List

All Configurations

<i>ITEM</i>	<i>QTY</i>	<i>PART NUMBER</i>	<i>DESCRIPTION</i>	<i>MATERIAL</i>
1	1	MB6010-0101A	Impeller Case	Gray Iron
2	1	MB6010-0500A	Drive Rotor	Ductile Iron
3	1	MB6010-0600A	Driven Rotor	Ductile Iron
4	1	M60-1102	Drive Helical Gear	Alloy Steel
5	1	M60-1101	Driven Helical Gear	Alloy Steel
6	2	MB60101	Locking Assembly (Z7B 80X145)	Steel
7	2	MB60102	Spherical Roller Bearing (22312)	Steel
8	2	MB60103	Roller Bearing (NJ312E/C3)	Steel
9	4	M60-1012A	Ring Seal Stator Insert	Gray Iron
10	4	ZG-1011A-125	Ring Seal Rotor Sleeve	Steel
11	5	MB60104	O-Ring (60 X 3.55)(IDXCS)	Viton
12	12	M60-1013	Piston Ring	Alloy Iron
13	4	M60-1106B	Oil Slinger	Steel
14	1	M60-SJT	Lock Sleeve Assembly	Steel
15	1	M60-SYP	Oil Flinger Assembly	Steel
16	2	M60-1108	Gear Spacer	Steel
17	8	M60-1202A	Bearing Shim (0.5, 0.2mm)	Steel
17A	8	M60-1202A	Bearing Shim (0.1, 0.05mm)	Steel
18	1	MB60105	Key (C18 X 100)	Steel
19	1	M60-1021A	Wear Ring,	Steel
20	1	MB60106	Lip Seal (75 X 95 X 10)	Viton
21	4	MB45107	Plug (M20 X 1.5)	Steel
22	2	MB45108	Plug Magnetic (M20 X 1.5)	Steel
23	2	MB45109	Sight Glass (M20 X 1.5)	Steel
24	6	MB45111	Dowel Pin (B12 X 40)	Steel
25	2	M60-1205A	Cover Gasket	
26	1	M60-1201A	Cylinder Shim (0.1mm)	Fish paper
27	2	M60-0201A	Endplate	Gray Iron
28	1	M60-0311A	Gear Oil Cover	Aluminum
29	1	M60-0411A	Drive Side Oil Cover	Aluminum
30	1	M60-1107A	Oil Flinger (Gear Side)	Steel
31	40	MB60113	Stud Bolt (M12 X 150)	Steel
32	40	MB60114	Nut M12	Steel
33	40	MB60115	Washer 12	Steel
34	40	MB60116	Lock Washer 12	Alloy Steel
35	2	M60-0202	Bearing Clamp Plate	Steel
36	8	MB60112	Socket Head Screw (M10 X 20)	Steel



Model: MB6016 Parts List

All Configurations

<i>ITEM</i>	<i>QTY</i>	<i>PART NUMBER</i>	<i>DESCRIPTION</i>	<i>MATERIAL</i>
1	1	MB6016-0101A	Impeller Case	Gray Iron
2	1	MB6016-0500A	Drive Rotor	Ductile Iron
3	1	MB6016-0600A	Driven Rotor	Ductile Iron
4	1	M60-1102	Drive Helical Gear	Alloy Steel
5	1	M60-1101	Driven Helical Gear	Alloy Steel
6	2	MB60101	Locking Assembly (Z7B 80X145)	Steel
7	2	MB60102	Spherical Roller Bearing (22312)	Steel
8	2	MB60103	Roller Bearing (NJ312E/C3)	Steel
9	4	M60-1012A	Ring Seal Stator Insert	Gray Iron
10	4	ZG-1011A-125	Ring Seal Rotor Sleeve	Steel
11	5	MB60104	O-Ring (60 X 3.55)(IDXCS)	Viton
12	12	M60-1013	Piston Ring	Alloy Iron
13	4	M60-1106B	Oil Slinger	Steel
14	1	M60-SJT	Lock Sleeve Assembly	Steel
15	1	M60-SYP	Oil Flinger Assembly	Steel
16	2	M60-1108	Gear Spacer	Steel
17	8	M60-1202A	Bearing Shim (0.5, 0.2mm)	Steel
17A	8	M60-1202A	Bearing Shim (0.1, 0.05mm)	Steel
18	1	MB60105	Key (C18 X 100)	Steel
19	1	M60-1021A	Wear Ring,	Steel
20	1	MB60106	Lip Seal (75 X 95 X 10)	Viton
21	4	MB45107	Plug (M20 X 1.5)	Steel
22	2	MB45108	Plug Magnetic (M20 X 1.5)	Steel
23	2	MB45109	Sight Glass (M20 X 1.5)	Steel
24	6	MB45111	Dowel Pin (B12 X 40)	Steel
25	2	M60-1205A	Cover Gasket	
26	1	M60-1201A	Cylinder Shim (0.1mm)	Fish paper
27	2	M60-0201A	Endplate	Gray Iron
28	1	M60-0311A	Gear Oil Cover	Aluminum
29	1	M60-0411A	Drive Side Oil Cover	Aluminum
30	1	M60-1107A	Oil Flinger (Gear Side)	Steel
31	40	MB60113	Stud Bolt (M12 X 150)	Steel
32	40	MB60114	Nut M12	Steel
33	40	MB60115	Washer 12	Steel
34	40	MB60116	Lock Washer 12	Alloy Steel
35	2	M60-0202	Bearing Clamp Plate	Steel
36	8	MB60112	Socket Head Screw (M10 X 20)	Steel



Model: MB6024 Parts List

All Configurations

<i>ITEM</i>	<i>QTY</i>	<i>PART NUMBER</i>	<i>DESCRIPTION</i>	<i>MATERIAL</i>
1	1	MB6024-0101A	Impeller Case	Gray Iron
2	1	MB6024-0500A	Drive Rotor	Ductile Iron
3	1	MB6024-0600A	Driven Rotor	Ductile Iron
4	1	M60-1102	Drive Helical Gear	Alloy Steel
5	1	M60-1101	Driven Helical Gear	Alloy Steel
6	2	MB60101	Locking Assembly (Z7B 80X145)	Steel
7	2	MB60102	Spherical Roller Bearing (22312)	Steel
8	2	MB60103	Roller Bearing (NJ312E/C3)	Steel
9	4	M60-1012A	Ring Seal Stator Insert	Gray Iron
10	4	ZG-1011A-125	Ring Seal Rotor Sleeve	Steel
11	5	MB60104	O-Ring (60 X 3.55)(IDXCS)	Viton
12	12	M60-1013	Piston Ring	Alloy Iron
13	4	M60-1106B	Oil Slinger	Steel
14	1	M60-SJT	Lock Sleeve Assembly	Steel
15	1	M60-SYP	Oil Flinger Assembly	Steel
16	2	M60-1108	Gear Spacer	Steel
17	8	M60-1202A	Bearing Shim (0.5, 0.2mm)	Steel
17A	8	M60-1202A	Bearing Shim (0.1, 0.05mm)	Steel
18	1	MB60105	Key (C18 X 100)	Steel
19	1	M60-1021A	Wear Ring,	Steel
20	1	MB60106	Lip Seal (75 X 95 X 10)	Viton
21	4	MB45107	Plug (M20 X 1.5)	Steel
22	2	MB45108	Plug Magnetic (M20 X 1.5)	Steel
23	2	MB45109	Sight Glass (M20 X 1.5)	Steel
24	6	MB45111	Dowel Pin (B12 X 40)	Steel
25	2	M60-1205A	Cover Gasket	
26	1	M60-1201A	Cylinder Shim (0.1mm)	Fish paper
27	2	M60-0201A	Endplate	Gray Iron
28	1	M60-0311A	Gear Oil Cover	Aluminum
29	1	M60-0411A	Drive Side Oil Cover	Aluminum
30	1	M60-1107A	Oil Flinger (Gear Side)	Steel
31	40	MB60113	Stud Bolt (M12 X 150)	Steel
32	40	MB60114	Nut M12	Steel
33	40	MB60115	Washer 12	Steel
34	40	MB60116	Lock Washer 12	Alloy Steel
35	2	M60-0202	Bearing Clamp Plate	Steel
36	8	MB60112	Socket Head Screw (M10 X 20)	Steel



9.2 General Itemized Drawing of Configuration

Vertical Flow Configuration

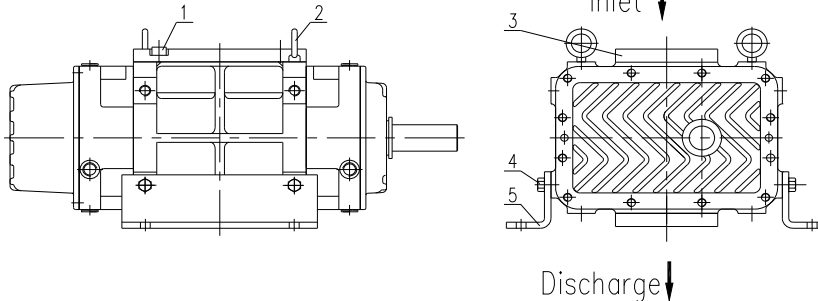

Horizontal Flow Configuration

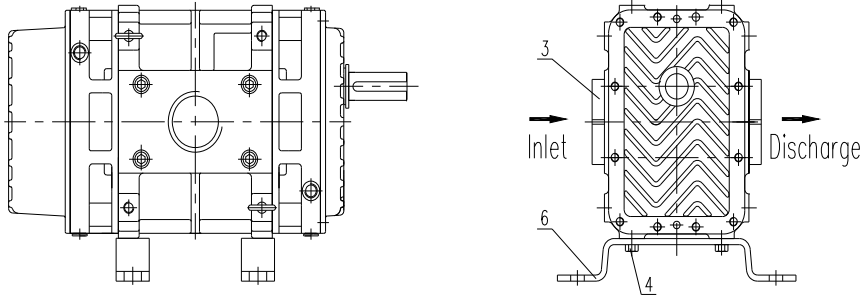

MB3004 All Configurations

ITEM	QTY	PART NUMBER	DESCRIPTION	MATERIAL
1	8	MB30119	Socket Head Screw UNC3/8" X 1"	Steel
2	2	MB30120	Ringbolt UNC 1/2"	Steel
3	2	ZG-0102-50UN	Port Adaptor	Steel
4	4	MB30121	Bolt UNC1/2" X 1"	Steel
5	2	MB3004-0103W-UN	Mounting Feet (Vertical Flow Configuration)	Steel
6	2	MB30-0103L-UN	Mounting Feet (Horizontal Flow Configuration)	Steel

MB3006 All Configurations

ITEM	QTY	PART NUMBER	DESCRIPTION	MATERIAL
1	8	MB30119	Socket Head Screw UNC3/8" X 1"	Steel
2	2	MB30120	Ringbolt UNC 1/2"	Steel
3	2	ZG-0102-65UN	Port Adaptor	Steel
4	4	MB30121	Bolt UNC1/2" X 1"	Steel
5	2	MB3006-0103W-UN	Mounting Feet (Vertical Flow Configuration)	Steel
6	2	MB30-0103L-UN	Mounting Feet (Horizontal Flow Configuration)	Steel



MB3007 All Configurations

<i>ITEM</i>	<i>QTY</i>	<i>PART NUMBER</i>	<i>DESCRIPTION</i>	<i>MATERIAL</i>
1	8	MB30119	Socket Head Screw UNC3/8" X 1"	Steel
2	2	MB30120	Ringbolt UNC 1/2"	Steel
3	2	ZG-0102-65UN	Port Adaptor	Steel
4	4	MB30121	Bolt UNC1/2" X 1"	Steel
5	2	MB3007-0103W-UN	Mounting Feet (Vertical Flow Configuration)	Steel
6	2	MB30-0103L-UN	Mounting Feet (Horizontal Flow Configuration)	Steel

MB4504 All Configurations

<i>ITEM</i>	<i>QTY</i>	<i>PART NUMBER</i>	<i>DESCRIPTION</i>	<i>MATERIAL</i>
1	N/A	N/A	N/A	N/A
2	2	MB45116	Ringbolt UNC 1/2"	Steel
3	N/A	N/A	N/A	N/A
4	4	MB45117	Bolt UNC1/2" X 1"	Steel
5	2	MB4504-0103W-UN	Mounting Feet (Vertical Flow Configuration)	Steel
6	2	MB45-0103L-UN-02	Mounting Feet (Horizontal Flow Configuration)	Steel

MB4506 All Configurations

<i>ITEM</i>	<i>QTY</i>	<i>PART NUMBER</i>	<i>DESCRIPTION</i>	<i>MATERIAL</i>
1	8	MB45115	Socket Head Screw UNC1/2" X 1-1/2"	Steel
2	2	MB45116	Ringbolt UNC 1/2"	Steel
3	2	M4506-0102UN	Port Adaptor	Steel
4	4	MB45117	Bolt UNC1/2" X 1"	Steel
5	2	MB4506-0103W-UN	Mounting Feet (Vertical Flow Configuration)	Steel
6	2	MB45-0103L-UN-02	Mounting Feet (Horizontal Flow Configuration)	Steel

MB4509 All Configurations

<i>ITEM</i>	<i>QTY</i>	<i>PART NUMBER</i>	<i>DESCRIPTION</i>	<i>MATERIAL</i>
1	8	MB45115	Socket Head Screw UNC1/2" X 1-1/2"	Steel
2	2	MB45116	Ringbolt UNC 1/2"	Steel
3	2	M4509-0102UN	Port Adaptor	Steel
4	4	MB45117	Bolt UNC1/2" X 1"	Steel
5	2	MB4509-0103W-UN	Mounting Feet (Vertical Flow Configuration)	Steel
6	2	MB45-0103L-UN-01	Mounting Feet (Horizontal Flow Configuration)	Steel

MB4512 All Configurations

<i>ITEM</i>	<i>QTY</i>	<i>PART NUMBER</i>	<i>DESCRIPTION</i>	<i>MATERIAL</i>
1	N/A	N/A	N/A	N/A
2	2	MB45116	Ringbolt UNC 1/2"	Steel
3	N/A	N/A	N/A	N/A
4	4	MB45117	Bolt UNC1/2" X 1"	Steel
5	2	MB4512-0103W-UN	Mounting Feet (Vertical Flow Configuration)	Steel
6	2	MB45-0103L-UN-01	Mounting Feet (Horizontal Flow Configuration)	Steel



MB4518 All Configurations

<i>ITEM</i>	<i>QTY</i>	<i>PART NUMBER</i>	<i>DESCRIPTION</i>	<i>MATERIAL</i>
1	N/A	N/A	N/A	N/A
2	2	MB45116	Ringbolt UNC 1/2"	Steel
3	N/A	N/A	N/A	N/A
4	4	MB45117	Bolt UNC1/2" X 1"	Steel
5	2	MB4518-0103W-UN	Mounting Feet (Vertical Flow Configuration)	Steel
6	2	MB45-0103L-UN-01	Mounting Feet (Horizontal Flow Configuration)	Steel

MB6010 All Configurations

<i>ITEM</i>	<i>QTY</i>	<i>PART NUMBER</i>	<i>DESCRIPTION</i>	<i>MATERIAL</i>
1	N/A	N/A	N/A	N/A
2	2	MB60115	Ringbolt UNC 5/8"	Steel
3	N/A	N/A	N/A	N/A
4	4	MB60116	Bolt UNC5/8" X 1"	Steel
5	2	MB6010-0103-UN	Mounting Feet (Vertical and Horizontal Flow Configuration)	Steel
6	2			

MB6016 All Configurations

<i>ITEM</i>	<i>QTY</i>	<i>PART NUMBER</i>	<i>DESCRIPTION</i>	<i>MATERIAL</i>
1	N/A	N/A	N/A	N/A
2	2	MB60115	Ringbolt UNC 5/8"	Steel
3	N/A	N/A	N/A	N/A
4	4	MB60116	Bolt UNC5/8" X 1"	Steel
5	2	MB6016-0103-UN	Mounting Feet (Vertical and Horizontal Flow Configuration)	Steel
6	2			

MB6024 All Configurations

<i>ITEM</i>	<i>QTY</i>	<i>PART NUMBER</i>	<i>DESCRIPTION</i>	<i>MATERIAL</i>
1	N/A	N/A	N/A	N/A
2	2	MB60115	Ringbolt UNC 5/8"	Steel
3	N/A	N/A	N/A	N/A
4	4	MB60116	Bolt UNC5/8" X 1"	Steel
5	2	MB6024-0103-UN	Mounting Feet (Vertical and Horizontal Flow Configuration)	Steel
6	2			



10. Maintenance Schedule Sheet

Rotary blower:	Serial Number:
----------------	----------------

Date	Description of work	Service hours	Signature