



Prices effective February 3, 2025

Published February 2025

# Caper® Chairs

HermanMiller list prices shown are in USD.

For HermanMiller Canadian prices, multiply the USD list price by a factor of 1.20---effective February 2025.

|  |               |
|--|---------------|
| <b>Introduction</b>  | <b>page 2</b> |
| <b>Caper® Chairs</b>   | <b>3</b>      |
| Multipurpose Chair   | 5             |
| Multipurpose Stool   | 7             |
| Stacking Stools  | 9             |
| Stacking Chairs  | 11            |
| Stacking Chair with Tablet Arm   | 15            |
| Storage Baskets  | 17            |
| Cart   | 19            |
| <b>Indices</b>   | <b>21</b>     |
| By Name  | 21            |
| By Number  | 23            |
| <b>Appendices</b>  |               |
| 20-Day or Less/Assigned Lead-Time Order Information  |               |
| Casters and Glides   |               |
| Textiles Application Chart-Seating   |               |
| Textile Colors   |               |
| <b>For the latest materials information, refer to the Materials pages on HermanMiller.com.</b> |               |

# Introduction

## A Note on the Organization of This Book

There are a few signals that will help you understand the organization of this book. Once you know them, you should be able to find your way around easily.

### Like a newspaper, this book is formatted with columns of text and illustrations that run vertically.

Information wraps from one column to the next and continues for as many pages as it needs to.

### Black bars are clues.

A black bar at the top of a page signals the start of information about a product.

This information is divided into two sections, each signaled by a black bar. Product Information includes a description, additional notes, and dimensional drawings. Specification Information, which always begins at the top of a column, includes a series of steps. Each step represents a decision you need to make in order to complete your product number. Steps must be followed sequentially. The number of pages needed to complete information on a product varies; some will be complete in one page; others may fill three or four pages. Just continue going through the steps until you run into the next product, signaled by the black bar at the top of the page.

Black tabs running along the outside edge of the page help you locate what section you are in or what section you want to go to. You can thumb forwards or backwards to find a section; tabs and text appear on both sides of the page.

The additional pages in the back of the book include the appendices and indices. They are signaled by a long black bar running along the outside edge of the page.

### The index is presented two ways.

The first index is in alphabetical order by product name. It can be helpful if you are new to the products and numbering scheme or if you are looking for a type of product, such as work chair or round table.

The second index is by product number. It lists, in alphanumeric order, the base product number, typically a five-digit number.

## General Information

This book is effective February 3, 2025, subject to change without notice. Products may be purchased from authorized Herman Miller dealers who will quote prices upon request. For more information about our products and services or to see a list of dealers, visit [www.HermanMiller.com](http://www.HermanMiller.com).

All prices are list prices. Additional services, such as planning services, design, storage, and installation, are not included and must be added to these prices when the additional services are requested.

Illustrations, specifications, and prices are based on the latest information at the time of publication. The right is reserved to make changes at any time without notice in prices, fabrics, finishes, materials, specifications, and models, and also to discontinue models and finishes.

Dimensions shown in the drawings are engineering drawing dimensions rounded up to the nearest  $\frac{1}{8}$ ". Product is shipped set up or knocked down. Products that include "Shipped knocked down" in the description require some assembly. If this statement does not appear in the description, the product is shipped assembled.

Service problems are normally handled by a Herman Miller authorized dealer. Where this cannot be accomplished on a local level, service problems should be referred to the Customer Care Representative for your region, Herman Miller, Inc., Zeeland, Michigan 49464.

### 20-Day or Less/Assigned Lead-Time Shipments

All products and options in this price book not designated by an Assigned Program icon  will ship in **20 business days or less** after being acknowledged by Herman Miller.

Products and options designated by an  are on the assigned lead-time program and may ship in 20 days, less than 20 days, or more than 20 days from order acknowledgement.

**Multipurpose Chair**

**Multipurpose Stools**

**Stacking Chairs**

**Cart**



# Multipurpose Chair

WC111  
WC121

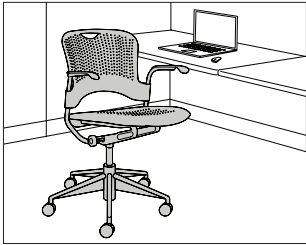

## Product Information

### Description

This multipurpose chair has a molded, flexible back that is perforated and contoured. It has a biomechanical tilt mechanism that synchronizes the movement of the chair's seat and back, pneumatic seat-height adjustment, and 5-star base with casters. The chair has 2 seat options: the molded seat is perforated and contoured; the Flexnet™ seat is suspension material. It is available with or without arms.

The multipurpose chair is breathable and distributes the user's weight evenly. Each chair is lightweight and mobile and has a cutout in the back for easy movement.

### Notes

Caper® chairs are not recommended for outdoor use.

For information on casters, see Casters and Glides in Appendices.

## Dimensions

### Molded Seat

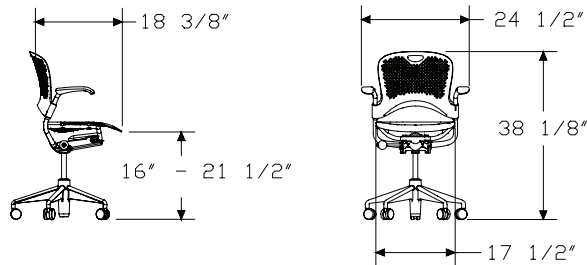

### FLEXNET Seat

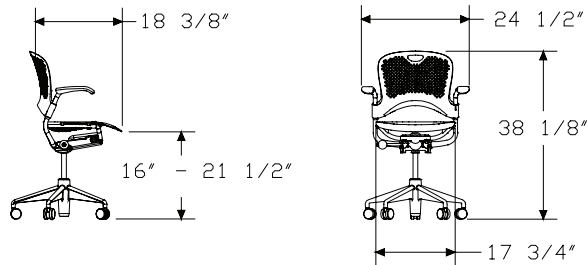

## Specification Information

### Step 1.

#### WC1

### Step 2. Seat Style

|    |               |         |
|----|---------------|---------|
| 11 | molded seat   | +\$938  |
| 21 | flexnet™ seat | +\$1154 |

### Step 3. Arms

|   |            |        |
|---|------------|--------|
| N | no arms    | +\$0   |
| P | fixed arms | +\$136 |

### Step 4. Frame Finish

|    |       |      |
|----|-------|------|
| BK | black | +\$0 |
|----|-------|------|

### Step 5. Seat/Back Finish

|     |                   |      |
|-----|-------------------|------|
| 3M  | berry blue        | +\$0 |
| 63  | fog               | +\$0 |
| 98  | studio white (CP) | +\$0 |
| BK  | black             | +\$0 |
| G1  | graphite (CP)     | +\$0 |
| RO  | red               | +\$0 |
| TRQ | turquoise         | +\$0 |
| ZK  | cappuccino        | +\$0 |

### Step 6. Casters

|    |  |       |
|----|--|-------|
| BB | 2 1/2" hard caster, black yoke, carpet only              | +\$0  |
| C7 | 2 1/2" caster, black yoke, hard floors or carpet         | +\$40 |
| C9 | 2 1/2" braking caster, black yoke, hard floors or carpet | +\$50 |

### Step 7. Arm Finish/Arm Cap Finish

#### For no arms (N)

|    |             |      |
|----|-------------|------|
| 63 | fog         | +\$0 |
| BK | black       | +\$0 |
| SY | silver grey | +\$0 |

#### For fixed arms (P)

|    |             |      |
|----|-------------|------|
| 63 | fog         | +\$0 |
| BK | black       | +\$0 |
| SY | silver grey | +\$0 |

Step 8. Flexnet™ Material  
*For flexnet™ seat (21)*  
*See application chart and textiles list for fabric usage and numbers. First 2 digits of number indicate fabric line; remaining digit(s) indicate fabric color.*

Price Category 1 +\$0

# Caper® Multipurpose Stool

WC751  
WC752

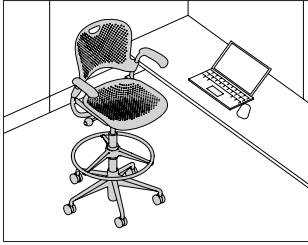

## Product Information

### Description

This multipurpose stool has a molded, flexible back that is perforated and contoured. It has a biomechanical tilt mechanism that synchronizes the movement of the stool's seat and back, pneumatic height adjustment and 5-star base. The stool has 2 seat options: the molded seat is perforated and contoured; the Flexnet™ seat is suspension material. It is available with or without arms.

The stool is breathable and distributes the user's weight evenly.

### Notes

Footrest available in trivalent chrome; column and ring support are black.

Caper® multipurpose stools are not recommended for outdoor use.

For information on casters, see Casters and Glides in Appendices.

## Dimensions

### Molded Seat

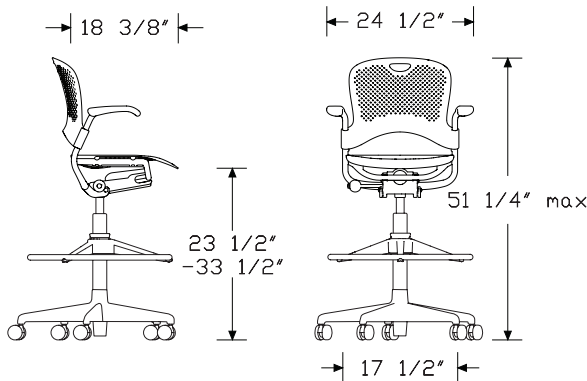

### Flexnet Seat

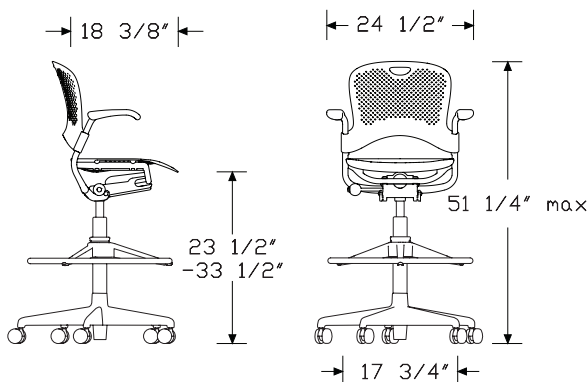

## Specification Information

### Step 1.

#### WC7

### Step 2. Height Adjustment

|   |                                 |         |
|---|---------------------------------|---------|
| 5 | 5-star base, stool height range | +\$1292 |
|---|---------------------------------|---------|

### Step 3. Seat Style

|    |               |        |
|----|---------------|--------|
| 11 | molded seat   | +\$0   |
| 21 | flexnet™ seat | +\$216 |

### Step 4. Arms

|   |            |        |
|---|------------|--------|
| N | no arms    | +\$0   |
| P | fixed arms | +\$136 |

### Step 5. Frame Finish

|    |       |      |
|----|-------|------|
| BK | black | +\$0 |
|----|-------|------|

### Step 6. Seat/Back Finish

|     |                   |      |
|-----|-------------------|------|
| 3M  | berry blue        | +\$0 |
| 63  | fog               | +\$0 |
| 98  | studio white (CP) | +\$0 |
| BK  | black             | +\$0 |
| G1  | graphite (CP)     | +\$0 |
| RO  | red               | +\$0 |
| TRQ | turquoise         | +\$0 |
| ZK  | cappuccino        | +\$0 |

### Step 7. Casters/Glides

|    |   |       |
|----|---|-------|
| BB | 2½" hard caster, black yoke, carpet only              | +\$0  |
| C7 | 2½" caster, black yoke, hard floors or carpet         | +\$40 |
| C9 | 2½" braking caster, black yoke, hard floors or carpet | +\$40 |
| GF | 2½" glide, hard floors or carpet                      | +\$0  |

### Step 8. Arm Finish/Arm Cap Finish

#### For no arms (N)

|    |             |      |
|----|-------------|------|
| 63 | fog         | +\$0 |
| BK | black       | +\$0 |
| SY | silver grey | +\$0 |

#### For fixed arms (P)

|    |             |      |
|----|-------------|------|
| 63 | fog         | +\$0 |
| BK | black       | +\$0 |
| SY | silver grey | +\$0 |

Step 9. Flexnet™ Material

*For flexnet™ seat (21)*

*See application chart and textiles list for fabric usage and numbers. First 2 digits of number indicate fabric line; remaining digit(s) indicate fabric color.*

Price Category 1

+\$0



# Caper® Stacking Stool

WC742  
WC743

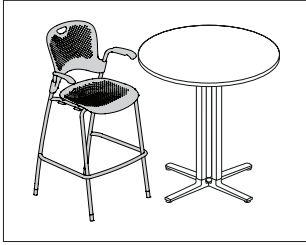

## Product Information

### Description

This stacking stool has a molded, flexible back that is perforated and contoured. The stool has a tubular steel frame and foot ring and comes in 24" (counter) and 30" (bar) heights. Available with or without arms.

The stool has 2 seat options: the molded seat is perforated and contoured; the Flexnet™ seat is suspension material. Each stool is breathable and distributes the users weight evenly.

The stool is lightweight and mobile. The 24" stool weighs 13.8 pounds and the 30" stool weighs 14.9 pounds. All styles of this stool can be stacked up to 5 high on the floor. Each seat back has a cutout for easy movement.

### Notes

Caper stacking stools are not recommended for outdoor use.

Glide color is predetermined based on arm finish/arm cap finish. For black (BK) and silver grey (SY), glides are black. For fog (63), glides are fog (63). For information on casters and glides, see Casters and Glides in appendices.

## Dimensions

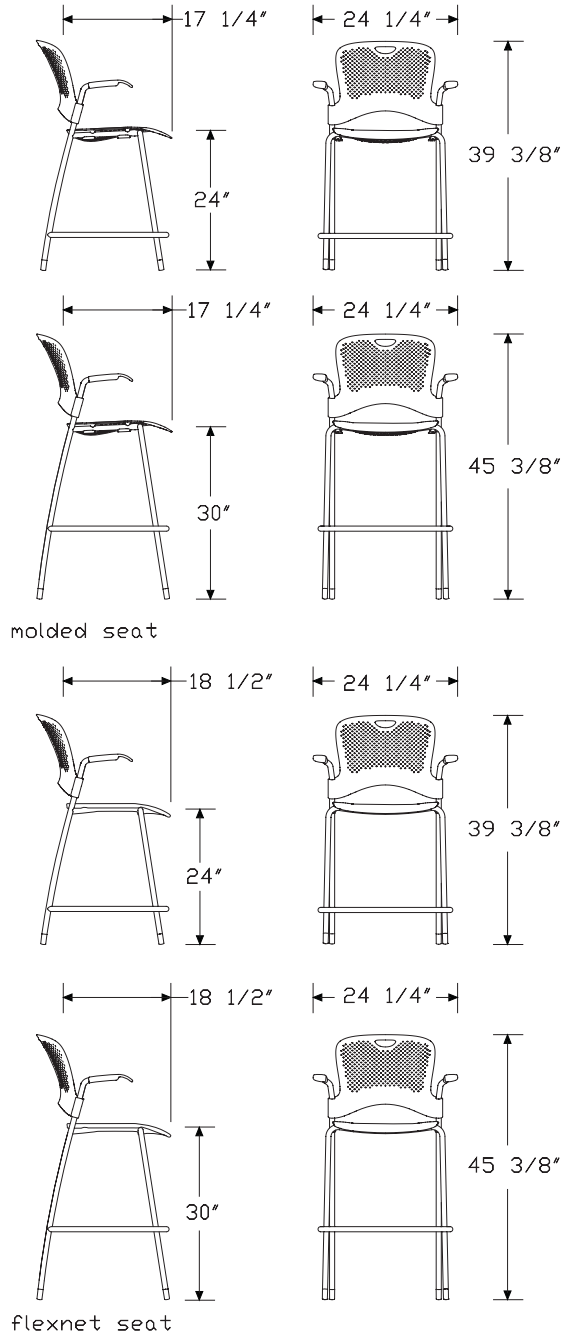

Caper® Multipurpose Stools

**Specification Information**

Step 1.

**WC7**

Step 2. Height Adjustment

|            |                                  |        |
|------------|----------------------------------|--------|
| <b>424</b> | 4-leg base, counter height range | +\$659 |
| <b>430</b> | 4-leg base, bar height range     | +\$659 |

Step 3. Seat Style

|           |               |        |
|-----------|---------------|--------|
| <b>10</b> | molded seat   | +\$0   |
| <b>20</b> | flexnet™ seat | +\$216 |

Step 4. Arms

|          |            |        |
|----------|------------|--------|
| <b>N</b> | no arms    | +\$0   |
| <b>P</b> | fixed arms | +\$136 |

Step 5. Frame Finish

|           |       |      |
|-----------|-------|------|
| <b>BK</b> | black | +\$0 |
|-----------|-------|------|

Step 6. Seat/Back Finish

|            |                   |      |
|------------|-------------------|------|
| <b>3M</b>  | berry blue        | +\$0 |
| <b>63</b>  | fog               | +\$0 |
| <b>98</b>  | studio white (CP) | +\$0 |
| <b>BK</b>  | black             | +\$0 |
| <b>G1</b>  | graphite (CP)     | +\$0 |
| <b>RO</b>  | red               | +\$0 |
| <b>TRQ</b> | turquoise         | +\$0 |
| <b>ZK</b>  | cappuccino        | +\$0 |

Step 7. Casters/Glides

|           |   |       |
|-----------|---|-------|
| <b>Y7</b> | acetal glide, carpet only                   | +\$0  |
| <b>YX</b> | Floor Saver Glide® insert, hard floors only | +\$25 |

Step 8. Arm Finish/Arm Cap Finish

*For acetal glide, carpet only (Y7)*

|           |             |      |
|-----------|-------------|------|
| <b>63</b> | fog         | +\$0 |
| <b>BK</b> | black       | +\$0 |
| <b>SY</b> | silver grey | +\$0 |

*For Floor Saver Glide® insert, hard floors only (YX)*

|           |             |      |
|-----------|-------------|------|
| <b>63</b> | fog         | +\$0 |
| <b>BK</b> | black       | +\$0 |
| <b>SY</b> | silver grey | +\$0 |

Step 9. Flexnet™ Material

*For flexnet™ seat (20)*

*See application chart and textiles list for fabric usage and numbers. First 2 digits of number indicate fabric line; remaining digit(s) indicate fabric color.*

Price Category 1 +\$0

# Stacking Chair

WC410  
WC420

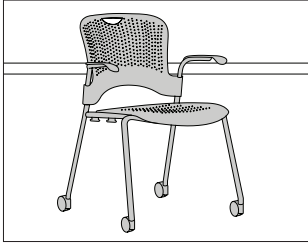

## Product Information

### Description

This stacking chair has a tubular steel frame, a molded back that is perforated and contoured, and a 4-leg base with casters or glides. It has 2 seat options: the molded seat is perforated and contoured; the Flexnet™ seat is suspension material. Each chair is breathable and distributes the user's weight evenly. The chair is available with or without arms.

The chair is lightweight and mobile. The molded chair without arms weighs 9½ pounds and the Flexnet chair with arms weighs 11½ pounds. All styles of this chair can be stacked up to 6-chairs high on the floor and up to 15-chairs high on the Caper® cart. Each chair has a cutout in the back for easy movement.

### Notes

Ganging stacking chairs (WC415 or WC425) can be stacked with armless stacking chairs (WC410N or WC420N) on the floor or on a Caper cart.

Caper chairs with installed storage basket will not stack. Order storage basket (WC6) separately.

Order optional Caper cart (WC904) separately.

Caper chairs are not recommended for outdoor use.

Glide color is predetermined based on arm finish/arm cap finish. For black (BK) and silver grey (SY), glides are black. For fog (63), glides are fog (63).

For information on casters and glides, see Casters and Glides in Appendices.

## Dimensions

### Molded Seat

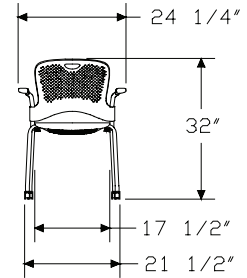
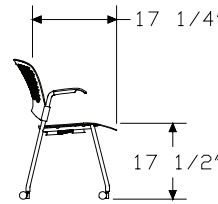

### FLEXNET Seat

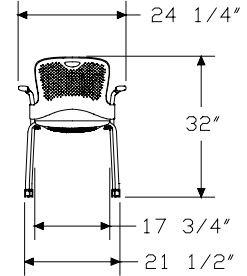
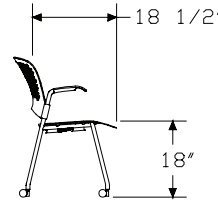

Caper® Stacking Chairs

Stacking Chair *continued*

Caper® Stacking Chairs

**Specification Information**

Step 1.

**WC4**

Step 2. Seat Style

|           |               |        |
|-----------|---------------|--------|
| <b>10</b> | molded seat   | +\$342 |
| <b>20</b> | flexnet™ seat | +\$557 |

Step 3. Arms

|          |            |        |
|----------|------------|--------|
| <b>N</b> | no arms    | +\$0   |
| <b>P</b> | fixed arms | +\$136 |

Step 4. Frame Finish

|           |       |      |
|-----------|-------|------|
| <b>BK</b> | black | +\$0 |
|-----------|-------|------|

Step 5. Seat/Back Finish

|            |                   |      |
|------------|-------------------|------|
| <b>3M</b>  | berry blue        | +\$0 |
| <b>63</b>  | fog               | +\$0 |
| <b>98</b>  | studio white (CP) | +\$0 |
| <b>BK</b>  | black             | +\$0 |
| <b>G1</b>  | graphite (CP)     | +\$0 |
| <b>RO</b>  | red               | +\$0 |
| <b>TRQ</b> | turquoise         | +\$0 |
| <b>ZK</b>  | cappuccino        | +\$0 |

Step 6. Casters/Glides

|           |  |       |
|-----------|--|-------|
| <b>Y7</b> | acetal glide, carpet only                        | +\$0  |
| <b>YX</b> | Floor Saver Glide® insert, hard floors only      | +\$25 |
| <b>U5</b> | soft wheel caster, carpet or hard floors         | +\$30 |
| <b>DS</b> | 2" soft double wheel braking caster, hard floors | +\$30 |

Step 7. Arm Finish/Arm Cap Finish

*For acetal glide, carpet only (Y7)*

|           |             |      |
|-----------|-------------|------|
| <b>63</b> | fog         | +\$0 |
| <b>BK</b> | black       | +\$0 |
| <b>SY</b> | silver grey | +\$0 |

*For Floor Saver Glide® insert, hard floors only (YX), soft wheel caster, carpet or hard floors (U5), or 2" soft double wheel braking caster, hard floors (DS)*

|           |             |      |
|-----------|-------------|------|
| <b>63</b> | fog         | +\$0 |
| <b>BK</b> | black       | +\$0 |
| <b>SY</b> | silver grey | +\$0 |

Step 8. Flexnet™ Material  
*For flexnet™ seat (20)*  
 See application chart and textiles list for fabric usage and numbers. First 2 digits of number indicate fabric line; remaining digit(s) indicate fabric color.  
 Price Category 1 +\$0

# Ganging Stacking Chair

WC415  
WC425

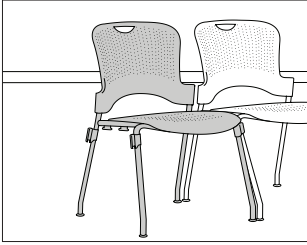

## Product Information

### Description

This ganging stacking chair has a tubular steel frame, a molded back that is perforated and contoured, and a 4-leg base with glides. It has 2 seat options: the molded seat is perforated and contoured; the Flexnet™ seat is suspension material. Each chair is breathable and distributes the user's weight evenly. The chair's ganging connectors are on the front and rear legs to ensure proper alignment.

The chair is lightweight and mobile and weighs 9½ pounds. It can be stacked up to 6-chairs high on the floor and up to 15-chairs high on the Caper® cart. Each chair has a cutout in the back for easy movement.

### Notes

Ganging connector finish matches frame finish.

Ganging stacking chairs (WC415 or WC425) can be stacked with armless stacking chairs (WC410N or WC420N) on the floor or on a Caper cart.

Caper chairs with installed storage basket will not stack. Order storage basket (WC6) separately.

Order optional Caper cart (WC904) separately.

Caper chairs are not recommended for outdoor use.

Glide color is predetermined based on arm finish/arm cap finish. For black (BK) and silver grey (SY), glides are black. For fog (63), glides are fog (63).

For information on glides, see Casters and Glides in Appendices.

## Dimensions

Molded Seat

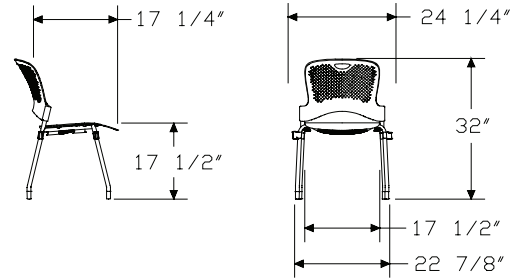

FLEXNET Seat

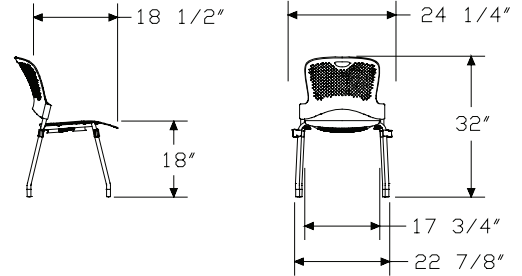

Caper® Stacking Chairs

# Ganging Stacking Chair *continued*

Caper® Stacking Chairs

| Specification Information   |   |        |
|---|---|--------|
| Step 1.   |   |        |
| <b>WC4</b>  |   |        |
| Step 2. Seat Style  |   |        |
| <b>15N</b>  | molded seat                                 | +\$396 |
| <b>25N</b>  | flexnet™ seat                               | +\$611 |
| Step 3. Frame Finish  |   |        |
| <b>BK</b>   | black                                       | +\$0   |
| Step 4. Seat/Back Finish  |   |        |
| <b>3M</b>   | berry blue                                  | +\$0   |
| <b>63</b>   | fog   | +\$0   |
| <b>98</b>   | studio white (CP)                           | +\$0   |
| <b>BK</b>   | black                                       | +\$0   |
| <b>G1</b>   | graphite (CP)                               | +\$0   |
| <b>RO</b>   | red   | +\$0   |
| <b>TRQ</b>  | turquoise                                   | +\$0   |
| <b>ZK</b>   | cappuccino                                  | +\$0   |
| Step 5. Glide Option  |   |        |
| <b>Y7</b>   | acetal glide, carpet only                   | +\$0   |
| <b>YX</b>   | Floor Saver Glide® insert, hard floors only | +\$25  |
| Step 6. Arm Cap Finish  |   |        |
| <i>For acetal glide, carpet only (Y7)</i>   |   |        |
| <b>63</b>   | fog   | +\$0   |
| <b>BK</b>   | black                                       | +\$0   |
| <b>SY</b>   | silver grey                                 | +\$0   |
| <i>For Floor Saver Glide® insert, hard floors only (YX)</i>   |   |        |
| <b>63</b>   | fog   | +\$0   |
| <b>BK</b>   | black                                       | +\$0   |
| <b>SY</b>   | silver grey                                 | +\$0   |
| Step 7. Flexnet™ Material   |   |        |
| <i>For flexnet™ seat (25N)</i>  |   |        |
| <i>See application chart and textiles list for fabric usage and numbers. First 2 digits of number indicate fabric line; remaining digit(s) indicate fabric color.</i> |   |        |
| Price Category 1  |   | +\$0   |

# Stacking Chair with Tablet Arm

WC510  
WC520

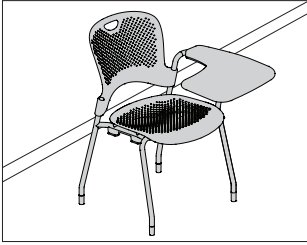

## Product Information

### Description

This stacking chair with tablet arm has a tubular steel frame, a molded back that is perforated and contoured, and a 4-leg base with glides. It has 2 seat options: the molded seat is perforated and contoured; the Flexnet™ seat is suspension material. Each chair is breathable and distributes the user's weight evenly. The tablet arm can be specified on the left or right side.

The tablet is wood and flat, and available in a variety of laminate options. It is 17<sup>7</sup>/<sub>8</sub>"W×20<sup>7</sup>/<sub>8</sub>"D. The tablet has a built-in dampener that prevents the tablet from falling down when extended.

This stacking chair with tablet can be stacked up to 3-chairs high on the floor or on the Caper® cart. Each chair has a cutout in the back for easy movement.

Tablet ships unassembled to the chair to prevent damage during shipping. The tablet fully extends to 135° in the up position for ease of getting into and out of the chair.

### Notes

Footprint of chair with tablet in down position is 32"H×25"W×31<sup>1</sup>/<sub>2</sub>"D.

Footprint of chair with tablet fully extended in up position is 32"H×35"W×31<sup>1</sup>/<sub>2</sub>"D.

Do not sit on or stack heavy objects on tablet arm. Product could tip and cause injury.

Chair with tablet cannot be ganged together.

Order optional Caper cart (WC904) separately.

Caper chairs are not recommended for outdoor use.

For information on glides, see Casters and Glides in appendices.

## Dimensions

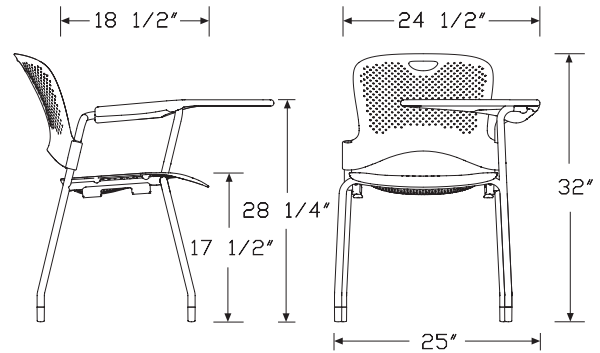

Molded Seat

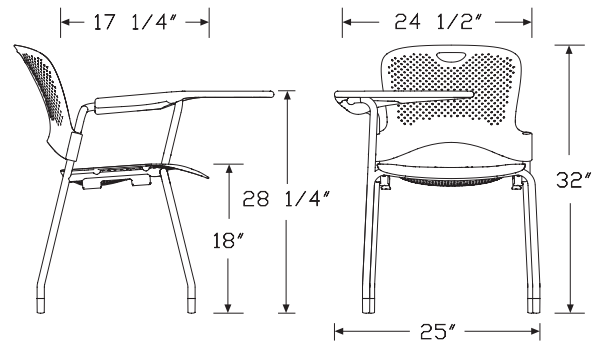

Flexnet Seat

Caper® Stacking Chairs

# Stacking Chair with Tablet Arm

continued

Caper® Stacking Chairs

## Specification Information

### Step 1.

**WC5**

### Step 2. Seat Style

**10** molded seat  +\$793  
**20** flexnet™ seat  +\$1008

### Step 3. Tablet Arm Orientation

**L** tablet arm left  +\$0  
**R** tablet arm right  +\$0

### Step 4. Frame Finish

**BK** black  +\$0

### Step 5. Seat/Back Finish

**3M** berry blue +\$0  
**63** fog  +\$0  
**98** studio white (CP)  +\$0  
**BK** black  +\$0  
**G1** graphite (CP)  +\$0  
**RO** red  +\$0  
**TRQ** turquoise  +\$0  
**ZK** cappuccino  +\$0

### Step 6. Glides

**Y7** acetal glide, carpet only  +\$0  
**YX** Floor Saver Glide® insert, hard floors only  +\$25

### Step 7. Arm Finish/Arm Cap Finish

#### For acetal glide, carpet only (Y7)

**63** fog  +\$0  
**BK** black  +\$0  
**SY** silver grey  +\$0

#### For Floor Saver Glide® insert, hard floors only (YX)

**63** fog  +\$0  
**BK** black  +\$0  
**SY** silver grey  +\$0

### Step 8. Tablet Finish

**125** natural maple (CP)  +\$0  
**126** natural cherry (CP)  +\$0  
**127** walnut (CP)  +\$0  
**139** light ash (CP)  +\$0  
**140** warm ash (CP)  +\$0  
**76** light brown walnut  +\$0  
**8Q** folkstone grey (CP)  +\$0  
**91** white (CP)  +\$0  
**98** studio white (CP)  +\$0  
**CL** cool grey neutral  +\$0  
**HF** inner tone light  +\$0  
**HP** light anigre  +\$0  
**LBA** clear on ash (CP)  +\$0  
**LBR** phantom ecru  +\$0  
**LBS** phantom cocoa  +\$0  
**LBU** medium matte walnut (CP)  +\$0  
**LBV** warm grey teak  +\$0  
**LBB** oak on ash (CP)  +\$0  
**LBC** walnut on ash (CP)  +\$0  
**LBF** neutral twill  +\$0  
**LBJ** graphite twill  +\$0  
**LBQ** white twill  +\$0  
**LT** light tone  +\$0  
**LU** soft white  +\$0  
**WL** warm stone (CP)  +\$0  
**WN** warm grey neutral  +\$0

### Step 9. Flexnet™ Material

*For flexnet™ seat (20)*  
 See application chart and textiles list for fabric usage and numbers. First 2 digits of number indicate fabric line; remaining digit(s) indicate fabric color.

Price Category 1 +\$0



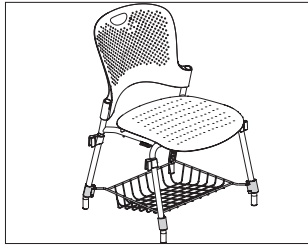

**Product Information**

**Description**

This storage basket installs in the field to all models of new or existing Caper® stacking chairs. Basket shape and wire mesh design prevent items from falling off or sliding back. Ships unassembled from the chair. Package contains 1 storage basket.

**Notes**

Basket maximum weight capacity is 30 pounds.

Specify basket finish to match chair frame finish.

Caper chairs with installed storage basket will not stack.

Order stacking chairs separately:

- Stacking chair (WC410, WC420)
- Ganging stacking chair (WC415N, WC425N)
- Stacking chair with tablet arm (WC510, WC520)

**Dimensions**

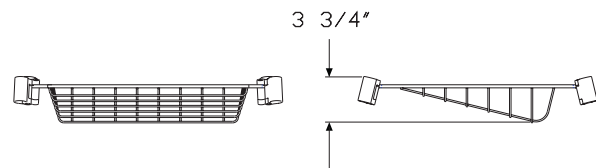
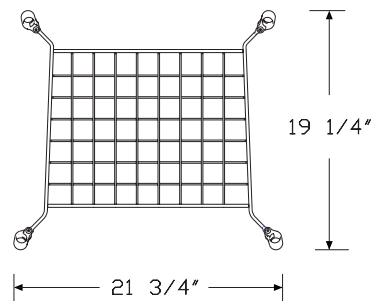

**Specification Information**

**Step 1.**

**WC6** A

**Step 2. Quantity per Box**

**01** one storage basket per box A +\$145

**Step 3. Finish**

**BK** black A +\$0

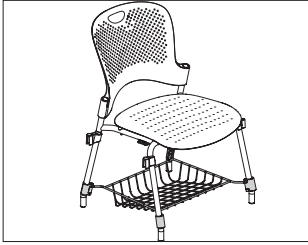

Caper® Stacking Chairs

**Product Information**

**Description**

This storage basket installs in the field to all models of new or existing Caper® stacking chairs. Basket shape and wire mesh design prevent items from falling off or sliding back. Ships unassembled from the chair. Package contains 4 storage baskets.

**Notes**

Basket maximum weight capacity is 30 pounds.

Specify basket finish to match chair frame finish.

Caper chairs with installed storage basket will not stack.

Order stacking chairs separately:

- Stacking chair (WC410, WC420)
- Ganging stacking chair (WC415N, WC425N)
- Stacking chair with tablet arm (WC510, WC520)

**Dimensions**

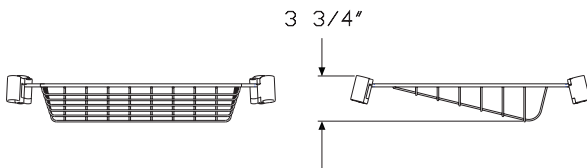
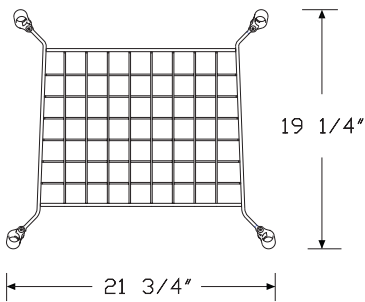

**Specification Information**

**Step 1.**

**WC6** A

**Step 2. Quantity per Box**

**04** four storage baskets per box A +\$544

**Step 3. Finish**

**BK** black A +\$0

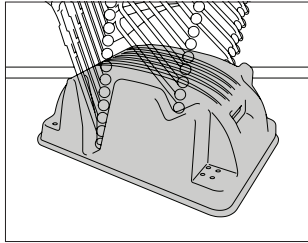

**Product Information**

**Description**

This cart stores and transports up to 15 Caper® stacking chairs or ganging stacking chairs, or up to 3 Caper stacking chairs with tablet arm. It has molded-in handles and 4" diameter casters: 2 swivel and 2 rigid. The cart is single-piece-molded construction that ships fully assembled. Finish is black.

**Notes**

Ganging stacking chairs (WC415 or WC425) can be stacked with armless stacking chairs (WC410N or WC420N).

Caper stacking chairs with tablet arm (WC510 or WC520) can be stacked only with other Caper stacking chairs with tablet arm.

**Dimensions**

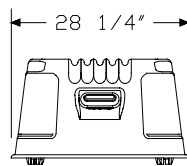
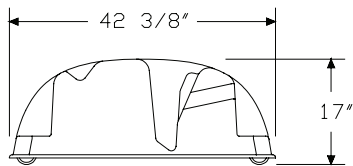

**Specification Information**

**Step 1.**

**WC904**

**\$718**



# Index by Product Name

| <b>Caper® Chairs</b>           |            |
|--------------------------------|------------|
| Caper® Cart                    | page(s) 19 |
| Caper® Multipurpose Stool      | 7          |
| Caper® Stacking Stool          | 9          |
| Caper® Storage Basket          | 17         |
| Caper® Storage Baskets         | 18         |
| Ganging Stacking Chair         | 13         |
| Multipurpose Chair             | 5          |
| Stacking Chair                 | 11         |
| Stacking Chair with Tablet Arm | 15         |



## Index by Product Number

|       |                                |           |
|-------|--------------------------------|-----------|
| WC111 | Multipurpose Chair             | page(s) 5 |
| WC121 |                                |           |
| WC410 | Stacking Chair                 | 11        |
| WC415 | Ganging Stacking Chair         | 13        |
| WC420 | Stacking Chair                 | 11        |
| WC425 | Ganging Stacking Chair         | 13        |
| WC510 | Stacking Chair with Tablet Arm | 15        |
| WC520 |                                |           |
| WC601 | Caper® Storage Basket          | 17        |
| WC604 | Caper® Storage Baskets         | 18        |
| WC742 | Caper® Stacking Stool          | 9         |
| WC743 |                                |           |
| WC751 | Caper® Multipurpose Stool      | 7         |
| WC752 |                                |           |
| WC904 | Caper® Cart                    | 19        |







# 20-Day or Less/Assigned Lead-Time Order Information

## 20-Day or Less and Assigned Lead-Time Programs

20-day or less and assigned lead-time products are designed for established Herman Miller dealers with pre-approved credit.

Products are distributed from multiple manufacturing facilities across the United States. All products and options not designated by an Assigned Lead-Time icon  will ship in 20 business days or less after being acknowledged by Herman Miller. Products and options designated by an  are on the assigned lead-time program and will ship in 20 days, less than 20 days, or more than 20 days from order acknowledgement.

## Ordering Procedure

Please place orders through Order Manager. If this is not available to you, place orders through mail or fax. Verbal purchase orders will not be accepted.

Order Entry fax number for Meridian®

Filing and Storage: (616) 846 9236.

Order Entry fax number for all other products:

(616) 654 3085.

For more information, contact your Customer Care representative at:  
(866) 854 3048 ext 3400.

## Shipments and Delivery

Per Herman Miller Terms and Conditions.

## Changes and Cancellation

Per Herman Miller Terms and Conditions.



# Casters and Glides

|   |                |   |
|---|----------------|---|
| ▲   | <b>WARNING</b> | ▲ |
| Depending on the floor surface, chair may unexpectedly roll away from user when entering or exiting the chair, possibly leading to unexpected injury. Please refer to descriptions of floor types when selecting casters. |                |   |

**32 Caster**

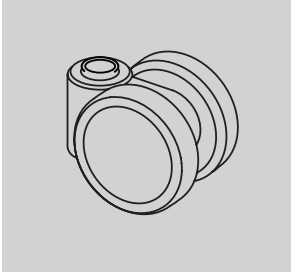

1<sup>7</sup>/<sub>8</sub>-inch-diameter hard double-wheel caster; black nylon wheels and yoke; for use on carpet only  
 Applicable on:  
 Sayl® Chairs

**BB Caster**

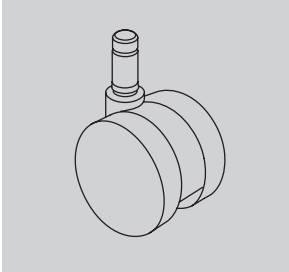

2<sup>1</sup>/<sub>2</sub>-inch-diameter hard double-wheel caster; black nylon wheels and yoke; for use on carpet only  
 Applicable on:  
 Asari Chair by Herman Miller™  
 New Aeron® Chairs  
 Caper® Chairs  
 Embody® Chairs  
 Fuld Nesting Chairs  
 Lino™ Chairs  
 Sayl Chairs  
 Mirra® 2 Chairs, Verus™ Chairs

**BSC Caster**

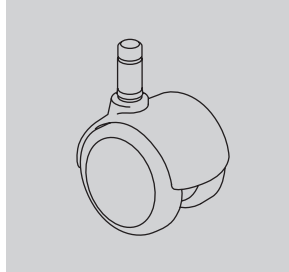

2-inch-diameter double-wheel caster; black nylon wheels and hood; soft polyurethane tread; for use on hard floors or carpet  
 Applicable on:  
 Eames® Aluminum Group  
 Eames Executive Chairs  
 Eames Soft Pad Group  
 Eames Task Chairs

**C9 Caster**

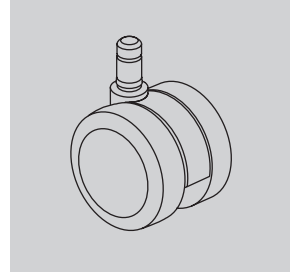

2<sup>1</sup>/<sub>2</sub>-inch-diameter double-wheel caster; black nylon wheels and yoke; soft polyurethane tread; internal brake; for use on hard floors or carpet  
 Applicable on:  
 Caper Chairs  
 Embody Chairs  
 Lino Chairs  
 Mirra 2 Chairs  
 Sayl Chairs  
 Setu® Chairs  
 Verus Chairs

**49 Caster**

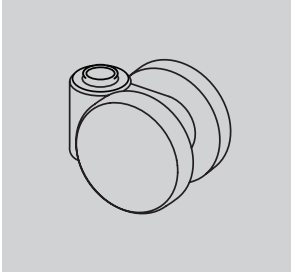

1<sup>7</sup>/<sub>8</sub>-inch-diameter soft double-wheel caster; black nylon wheels and yoke; for use on hard floors or carpet  
 Applicable on:  
 Sayl Chairs

**BKS Caster**

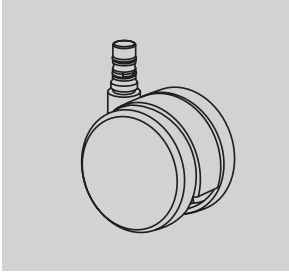

2<sup>1</sup>/<sub>2</sub>-inch-diameter hard double-wheel caster; black yoke; quiet roll technology; for use on carpet only  
 Applicable on:  
 Cosm™ Chairs

**C7 Caster**

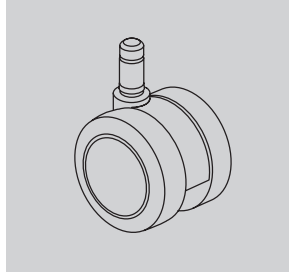

2<sup>1</sup>/<sub>2</sub>-inch-diameter double-wheel caster; black nylon wheels and yoke; soft polyurethane tread; for use on hard floors or carpet  
 Applicable on:  
 Asari Chair by Herman Miller™  
 New Aeron Chairs  
 Caper Chairs  
 Embody Chairs  
 Fuld Nesting Chairs  
 Lino Chairs                      Sayl Chairs  
 Mirra 2 Chairs                Verus Chairs

**CSQ Caster**

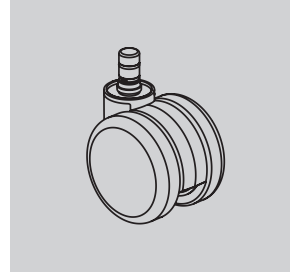

2<sup>1</sup>/<sub>2</sub>-inch-diameter double-wheel caster; color-matched nylon wheels and yoke; soft polyurethane tread; for use on hard floors or carpet  
 Applicable on:  
 Zeph® Chairs

# Casters and Glides

continued

**DC1 Caster**

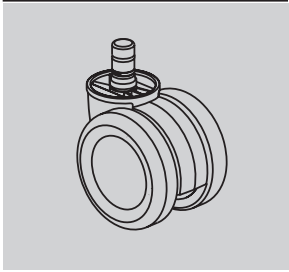

2<sup>1</sup>/<sub>2</sub>-inch-diameter double-wheel braking caster; black nylon wheels and yoke; for use on hard floors or carpet; quiet roll technology

Applicable on:

New Aeron Chairs

**H9 Caster**

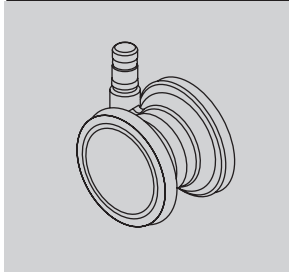

2<sup>1</sup>/<sub>2</sub>-inch-diameter double-wheel caster; clear polycarbonate wheels; nylon yoke; soft polyurethane tread; for use on carpet only

Applicable on:

Embody Chairs

**MD Caster**

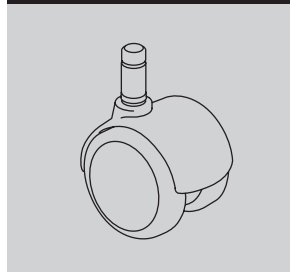

2-inch-diameter double-wheel caster; black nylon wheels with integral chrome hood; soft polyurethane tread; for use on hard floors or carpet

Applicable on:

Eames® Aluminum Group  
Eames Executive Chairs  
Eames Soft Pad Group  
Eames Task Chairs

**OC Caster**

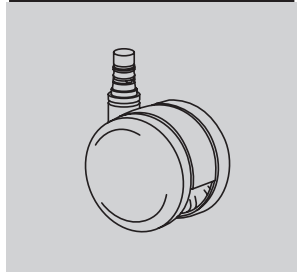

2<sup>1</sup>/<sub>2</sub>-inch-diameter double-wheel medium roll-resistant caster; black nylon wheels and yoke; soft polyurethane tread; for use on hard floors or carpet; quiet roll technology

Applicable on:

Cosm Chairs  
Fuld Nesting Chairs  
Setu Chairs

**DS Caster**

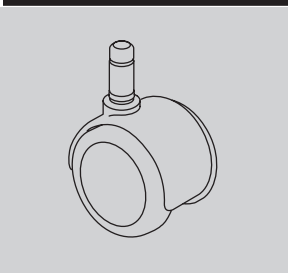

2-inch-diameter soft double-wheel braking caster; black nylon wheels and hood; for use on hard floors only

Applicable on:

Aside® Chairs  
Caper Chairs

**HCC Caster**

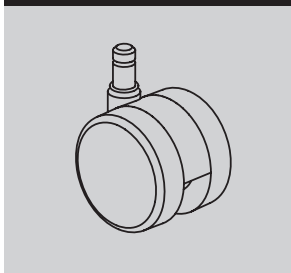

2<sup>1</sup>/<sub>2</sub>-inch-diameter double-wheel low roll resistance caster; black yoke; for use on hard floors or carpet

Applicable on:

Setu Chairs

**O2 Caster**



2<sup>1</sup>/<sub>2</sub>-inch-diameter double-wheel caster; nylon wheels and yoke; soft polyurethane tread; quiet roll technology; for use on hard floors or carpet

Applicable on:

Cosm Chairs

**SC8 Caster**



2<sup>1</sup>/<sub>2</sub>-inch-diameter double-wheel caster; black nylon wheels and yoke; soft polyurethane tread; quiet roll technology; for use on hard floors or carpet

Applicable on:

Cosm Chairs  
Fuld Nesting Chairs  
Lino Chairs  
Mirra 2 Chairs  
Verus Chairs

# Casters and Glides

continued

**U4 Caster**

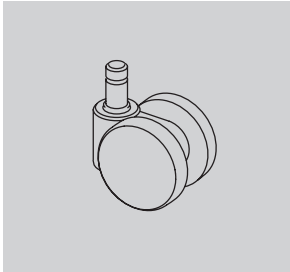

1<sup>7</sup>/<sub>8</sub>-inch-diameter hard double-wheel caster; black nylon wheels and yoke; for use on carpet only

Applicable on:

Aside Chairs  
Verus Chairs

**UD Caster**

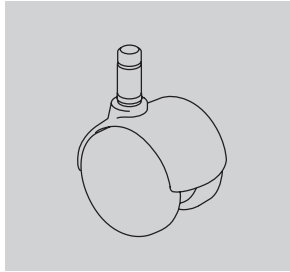

2-inch-diameter hard double-wheel caster; black nylon wheels with painted hood; for use on carpet only

Applicable on:

Eames® Aluminum Group  
Eames Executive Chairs  
Eames Soft Pad Group  
Eames Task Chairs

**16 Glide**

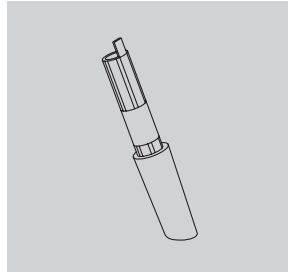

(Front glide shown)  
2<sup>1</sup>/<sub>8</sub>-inch-high glide; black or fog acetal; for use on carpet only

Applicable on:

Sayl Chairs

**FGG Glide**

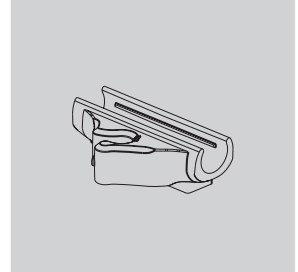

1/2-inch-high ganging glide; black ABS plastic with black felt bottom; for use on resilient flooring

Applicable on:

Pronta Stacking Chairs

**U5 Caster**

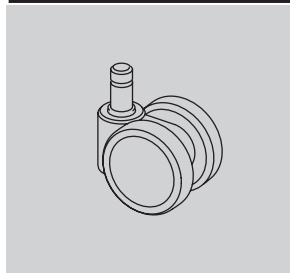

1<sup>7</sup>/<sub>8</sub>-inch-diameter soft double-wheel caster; black nylon wheels and yoke; for use on hard floors or carpet

Applicable on:

Aside Chairs  
Caper Chairs  
Verus Chairs

**VD Caster**

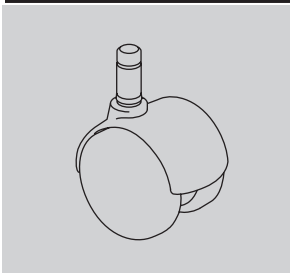

2-inch-diameter hard double-wheel caster; black nylon wheels with integral chrome hood; for use on carpet only

Applicable on:

Eames Aluminum Group  
Eames Executive Chairs  
Eames Soft Pad Group  
Eames Task Chairs

**69 Glide**

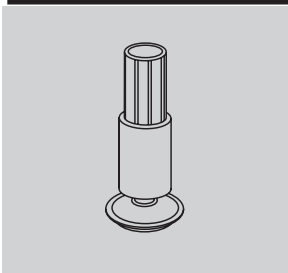

(Front glide shown)  
2<sup>1</sup>/<sub>8</sub>-inch-high glide; black glass-filled nylon stem; steel-plated swivel foot with Floor Saver Glide™ insert; for use on hard floors only

Applicable on:

Sayl Chairs

**FTG Glide**

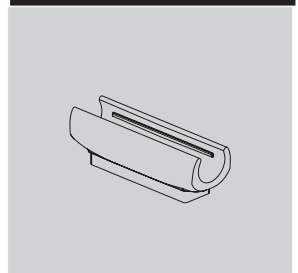

1/2-inch-high glide; black ABS plastic with black felt bottom; for use on resilient flooring

Applicable on:

Pronta Stacking Chairs

# Casters and Glides

continued

## G4 Glide

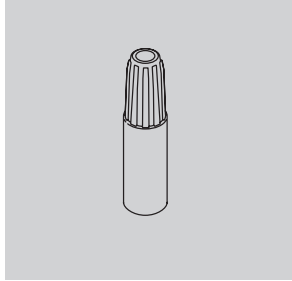

1 7/8-inch-high glide; black acetal; for use on carpet only

Applicable on:

Verus Chairs

## GF Glide

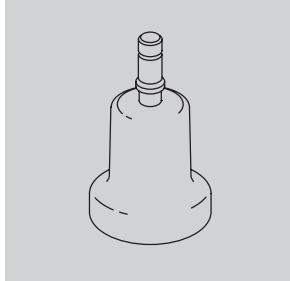

2 1/2-inch-high glide; black nylon; for use on hard floors or carpet

Applicable on:

New Aeron Chairs  
Caper Chairs  
Cosm Chairs  
Lino Chairs  
Mirra 2 Chairs  
Sayl Chairs  
Verus Chairs

## GG Glide

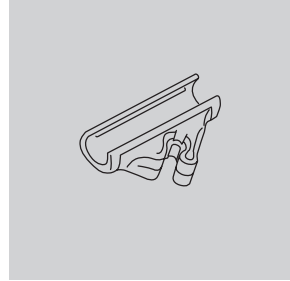

1/2-inch-high ganging glide; clear polycarbonate; for use on hard floors or carpet

Applicable on:

Pronta Stacking Chairs

## GLN Glide

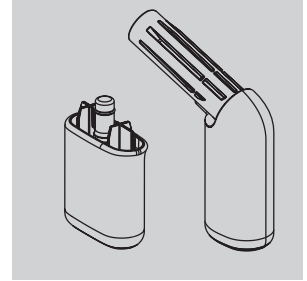

Acetal glide; for use on carpet only

Applicable on:

Fuld Nesting Chairs

## GD Glide

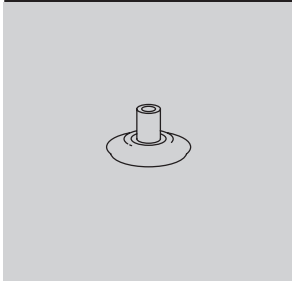

1 1/2-inch-diameter glide; 1/2 inch in height; black nylon; for use on hard floors or carpet

Applicable on:

Eames Aluminum Group  
Eames Executive Chairs  
Eames Soft Pad Group  
Eames Task Chairs

## GFG Glide



Floor Saver Glide™ insert; for use on hard floors only

Applicable on:

Zeph Chairs

## GL Glide

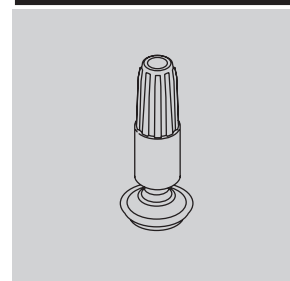

1 7/8-inch-high glide; black nylon stem; steel-plated swivel foot with Floor Saver Glide™ insert; for use on hard floors only

Applicable on:

Verus chairs

## GNB Glide

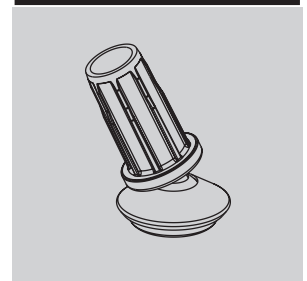

Swivel glide; nylon base; for use on carpet only

Applicable on:

Zeph Chairs

# Casters and Glides

continued

## HG Glide



1/2-inch-high glide; black nylon glide with stainless-steel insert; for use on hard floors or carpet

Applicable on:  
Aside Chairs

## SG Glide (for Prona)

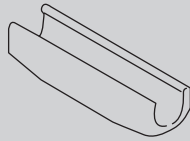

1/2-inch-high glide; clear polycarbonate; for use on hard floors or carpet

Applicable on:  
Prona Stacking Chairs

## XS Glide

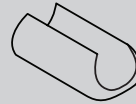

1/8-inch-high glide; polycarbonate in black, fog, clear, and studio white finishes; for use on hard floors or carpet

Applicable on:  
Sayl Chairs

## YX Glide

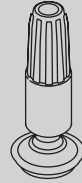

1 7/8-inch-high glide; black nylon stem; steel-plated swivel foot with Floor Saver Glide™ insert; for use on hard floors only

Applicable on:  
Caper Chairs

## SG Glide (for Aside)



1/2-inch-high glide; black nylon; for use on carpet only

Applicable on:  
Aside Chairs

## X8 Glide



Glide; low profile; for use on hard floors or carpet

Applicable on:  
Setu Chairs

## Y7 Glide



1 7/8-inch-high glide; black acetal; for use on carpet only

Applicable on:  
Caper Chairs





# Textiles Application Chart — Seating

• Available

[A] Assigned lead-time textile.

[A] Maharam textiles are on assigned lead times.

[N] Non-woven textile.

See below for exception notes.

## Price Category 1

|                                 | Aeron® Chairs | Asari Work Chairs by Herman Miller™ | Cosm™ Chairs | Mirra® 2 Chairs/Stools | Embody® Chairs | Fluid Nesting Chairs | Sayl® Work Chairs/Stools | Sayl Side Chairs | Setu® Chairs/Stools | Zeph® Chairs | Verus™ Work Chairs/Stools Back | Verus Work Chairs/Stools Seat | Verus Side Chairs Back | Verus Side Chairs Seat | Verus Plus Chairs | Aside® Chairs | Caper® Chairs/Stools | Lino™ Chairs Back | Lino Chairs Seat | OE1 Storage Trolley Cushion Top | Plex® Lounge Furniture | Swoop™ Lounge Seating - Fully Upholstered | Swoop Lounge Seating - Plywood | Valor™ Seating | Eames® Tandem Sling Seating | Cushion Tops | Workspaces |   |
|---------------------------------|---------------|-------------------------------------|--------------|------------------------|----------------|----------------------|--------------------------|------------------|---------------------|--------------|--------------------------------|-------------------------------|------------------------|------------------------|-------------------|---------------|----------------------|-------------------|------------------|---------------------------------|------------------------|---|--------------------------------|----------------|-----------------------------|--------------|------------|---|
| COM Customer's Own Material [A] |               |                                     |              |                        |                |                      | 1                        | 1                |                     |              | 1                              | 1                             | 1                      | 1                      | 1                 | 1             |                      |                   |                  | 1                               | 1                      | 1   | 1                              | 1              | 1                           | 1            | 1          | 1 |
| 231__ 8Z Pellicle®              | •             |                                     |              |                        |                |                      |                          |                  |                     |              |                                |                               |                        |                        |                   |               |                      |                   |                  |                                 |                        |   |                                |                |                             |              |            |   |
| 1A7__ AireWeave™ 2              |               |                                     |              | •                      |                |                      |                          |                  |                     |              |                                |                               |                        |                        |                   |               |                      |                   |                  |                                 |                        |   |                                |                |                             |              |            |   |
| 8T__ Crossing                   |               |                                     |              |                        |                |                      |                          |                  | •                   |              |                                |                               |                        |                        |                   | •             |                      |                   |                  |                                 | •                      |   | •                              |                |                             | •            | •          |   |
| 3DE__ Dex                       |               |                                     |              |                        |                |                      | •                        | •                | •                   |              | •                              | •                             | •                      | •                      | •                 | •             |                      |                   |                  | •                               | 19                     | •   |                                | •              |                             | •            | •          |   |
| 4RM__ Duo                       |               |                                     |              |                        |                |                      |                          |                  |                     |              |                                |                               |                        |                        |                   |               |                      | •                 |                  |                                 |                        |   |                                |                |                             |              |            |   |
| 6V__ Flexnet™                   |               |                                     |              |                        |                |                      |                          |                  |                     |              |                                |                               |                        |                        |                   |               | •                    |                   |                  |                                 |                        |   |                                |                |                             |              |            |   |
| 845__ Intercept                 |               |                                     | •            |                        |                |                      |                          |                  |                     |              |                                |                               |                        |                        |                   |               |                      |                   |                  |                                 |                        |   |                                |                |                             |              |            |   |
| 365__ Interweave 2              |               |                                     |              |                        |                |                      |                          |                  |                     |              | •                              |                               | •                      |                        |                   |               |                      |                   |                  |                                 |                        |   |                                |                |                             |              |            |   |
| 4W__ Lyriss 2™                  |               |                                     |              |                        |                |                      |                          |                  | •                   |              |                                |                               |                        |                        |                   |               |                      |                   |                  |                                 |                        |   |                                |                |                             |              |            |   |
| 1MN__ Monologue                 |               |                                     |              |                        |                |                      | 24                       | 22               | •                   |              |                                | •                             | •                      | •                      |                   |               |                      |                   |                  | •                               | •                      | •   | •                              | •              | •                           | •            | •          |   |
| 5H2__ Ripple 3D Knit            |               |                                     |              |                        |                |                      |                          |                  |                     | •            |                                |                               |                        |                        |                   |               |                      |                   |                  |                                 |                        |   |                                |                |                             |              |            |   |
| 5H1__ Splash 3D Knit            |               |                                     |              |                        |                |                      |                          |                  |                     | •            |                                |                               |                        |                        |                   |               |                      |                   |                  |                                 |                        |   |                                |                |                             |              |            |   |
| 4SC__ Scatter                   |               |                                     |              |                        |                |                      | •                        | •                | •                   |              | •                              | •                             | •                      | •                      | •                 | •             |                      |                   |                  | •                               | •                      | •   | •                              | •              | •                           | •            | •          |   |
| 3DN__ Scribe                    |               |                                     |              |                        |                |                      | 25                       | 22               | •                   |              | •                              |                               | •                      | •                      | •                 |               |                      |                   |                  | •                               | •                      |   |                                | •              |                             | •            | •          |   |
| 3DK__ Stretch Knit [A]          |               |                                     |              |                        |                |                      | 25                       |                  |                     |              |                                |                               |                        |                        |                   |               |                      |                   |                  |                                 |                        |   |                                |                |                             |              |            |   |
| 235__ Tailored                  |               |                                     |              |                        |                |                      | •                        | •                | •                   |              | •                              | •                             | •                      | •                      | •                 | •             |                      |                   | •                |                                 | 23                     |   | •                              |                | 7                           | •            |            |   |
| 9NK__ Tuck 3D Knit              |               |                                     |              |                        | •              |                      |                          |                  |                     |              |                                |                               |                        |                        |                   |               |                      |                   |                  |                                 |                        |   |                                |                |                             |              |            |   |
| 1WS__ Whisper                   |               |                                     |              |                        |                |                      | 24                       | •                | •                   |              | •                              | •                             | •                      | •                      | •                 | •             |                      |                   |                  | •                               | •                      | •   | •                              | •              | •                           | •            | •          |   |

## Price Category 2

|                              |  |  |  |   |    |  |    |    |    |  |    |    |    |    |    |   |  |  |  |    |   |   |   |    |   |   |   |
|------------------------------|--|--|--|---|----|--|----|----|----|--|----|----|----|----|----|---|--|--|--|----|---|---|---|----|---|---|---|
| 3AR__ Aristo                 |  |  |  |   |    |  | •  | •  | •  |  | •  | •  | •  | •  | •  | • |  |  |  | •  | • | • | • | •  | • | • | • |
| 92__ Crepe                   |  |  |  |   |    |  | •  | •  | •  |  | •  | •  | •  | •  | •  | • |  |  |  | •  | • | • | • | •  | • | • | • |
| 3EP__ Epic                   |  |  |  |   |    |  | •  | •  |    |  | •  | •  | •  | •  | •  | • |  |  |  | •  |   | • |   | •  |   | 7 | • |
| 3DP__ Hint                   |  |  |  |   |    |  | •  | •  |    |  | •  | •  | •  | •  | •  | • |  |  |  | •  |   |   |   | •  |   | • | • |
| 1MV__ Marvel [N]             |  |  |  |   |    |  | 25 | 22 | •  |  |    |    |    |    |    |   |  |  |  | •  |   |   |   | •  |   | • | • |
| 1HA__ Medley                 |  |  |  | • |    |  | •  | 22 |    |  | •  | •  | •  | •  | •  | • |  |  |  | •  | • | • | • | •  | • | • | • |
| 4ME__ Mellow                 |  |  |  |   |    |  | •  | 22 |    |  | •  | •  | •  | •  | •  | • |  |  |  | •  | • | • | • | •  | • | • | • |
| ZMA__ Metaphor - Maharam [A] |  |  |  |   |    |  | 16 | 16 | •  |  | •  |    | •  | •  | •  | • |  |  |  | •  | • | • | • | •  | • | • | • |
| 8I1__ Muse - Maharam [A]     |  |  |  |   |    |  | 16 | 16 |    |  | •  |    | •  |    |    |   |  |  |  | •  |   |   |   | 26 |   | • | • |
| 30__ Rhythm                  |  |  |  |   | 23 |  | •  | •  |    |  | •  | •  | •  | •  | •  | • |  |  |  | •  | • | • | • | •  | • | • | • |
| 3SL__ Sequel [N]             |  |  |  |   |    |  | 27 | 27 | 27 |  | 27 | 27 | 27 | 27 | 27 | 8 |  |  |  | 27 | • | • | • | •  | • | • | • |
| 4TE__ Terra                  |  |  |  |   |    |  | •  | 22 |    |  | •  | •  | •  | •  | •  | • |  |  |  | •  |   | • | • | •  | • | • | • |
| 8R__ Twist                   |  |  |  |   |    |  | •  | •  | •  |  | •  | •  | •  | •  | •  | • |  |  |  | •  | • | • | • | •  | • | • | • |

## Price Category 3

|                            |  |   |  |  |    |  |    |   |   |  |   |   |   |   |   |   |  |  |   |   |    |   |   |   |   |   |   |
|----------------------------|--|---|--|--|----|--|----|---|---|--|---|---|---|---|---|---|--|--|---|---|----|---|---|---|---|---|---|
| 3AC__ Ace                  |  |   |  |  |    |  | 25 | • |   |  | • | • | • | • | • | 8 |  |  | • | • | 19 |   | • |   | • | • |   |
| 43Z__ Fractal              |  |   |  |  |    |  | •  | • | • |  | • | • | • | • | • | • |  |  |   | • | •  | • | • | • | • | • | • |
| 8M__ Latitude™             |  |   |  |  | 23 |  |    |   |   |  |   |   |   |   |   |   |  |  |   |   |    |   |   |   |   |   |   |
| ZM2__ Meld - Maharam * [A] |  | • |  |  |    |  | •  | • | • |  | • | • | • | • | • | • |  |  |   | • | •  | • | • | • | • | • | • |
| 4GE__ Parcel               |  |   |  |  |    |  | •  | • | • |  | • | • | • | • | • | • |  |  |   | • | •  | • | • | • | • | • | • |

## Price Category 4

|                                |  |  |  |   |  |  |    |   |   |  |   |   |   |   |   |   |  |  |   |   |    |   |   |   |   |   |   |
|--------------------------------|--|--|--|---|--|--|----|---|---|--|---|---|---|---|---|---|--|--|---|---|----|---|---|---|---|---|---|
| 3DM__ Daydream                 |  |  |  |   |  |  | 25 | • | • |  | • |   | • | • | • | • |  |  | • | • | •  | • | • |   | • | • |   |
| ZLR__ Lariat - Maharam [N] [A] |  |  |  |   |  |  | •  | • | • |  | • | • | • | • | • | • |  |  |   | • | 20 |   | • |   | • | • |   |
| 3SY__ Sync                     |  |  |  | • |  |  | •  | • | • |  | • | • | • | • | • | • |  |  |   | • | •  | • | • | • | • | • | • |

continued on next page

# Textiles Application Chart — Seating continued

• Available

[A] Assigned lead-time textile.

[A] Maharam textiles are on assigned lead times.

[N] Non-woven textile.

See below for exception notes.

|  | Aeron® Chairs | Asari Work Chairs by Herman Miller™ | Cosm™ Chairs | Mirra® 2 Chairs/Stools | Embody® Chairs | Fuld Nesting Chairs | Say® Work Chairs/Stools | Say Side Chairs | Setu® Chairs/Stools | Zeph® Chairs | Verus™ Work Chairs/Stools Back | Verus Work Chairs/Stools Seat | Verus Side Chairs Back | Verus Side Chairs Seat | Verus Plus Chairs | Aside® Chairs | Caper® Chairs/Stools | Lino™ Chairs Back | Lino Chairs Seat | OE1 Storage Trolley Cushion Top | Plex® Lounge Furniture | Swoop™ Lounge Seating - Fully Upholstered | Swoop Lounge Seating - Plywood | Valor™ Seating | Eames® Tandem Sling Seating | Cushion Tops | Workspaces |
|--|---------------|-------------------------------------|--------------|------------------------|----------------|---------------------|-------------------------|-----------------|---------------------|--------------|--------------------------------|-------------------------------|------------------------|------------------------|-------------------|---------------|----------------------|-------------------|------------------|---------------------------------|------------------------|---|--------------------------------|----------------|-----------------------------|--------------|------------|
| <b>Price Category 5</b>                |               |                                     |              |                        |                |                     |                         |                 |                     |              |                                |                               |                        |                        |                   |               |                      |                   |                  |                                 |                        |   |                                |                |                             |              |            |
| 5YT__Arlo - Maharam [A]                |               |                                     |              |                        |                |                     |                         |                 |                     |              |                                |                               |                        |                        |                   |               |                      |                   |                  |                                 |                        |   |                                |                |                             |              |            |
| 3CY__Cozy                              |               |                                     |              |                        |                |                     |                         |                 |                     |              |                                |                               |                        |                        |                   |               |                      |                   |                  |                                 |                        |   |                                |                |                             |              |            |
| 14A__Hopsak                            |               |                                     |              |                        |                |                     |                         |                 |                     |              |                                |                               |                        |                        |                   |               |                      |                   |                  |                                 |                        |   |                                |                |                             |              |            |
| 40G__Method - Maharam [A]              |               |                                     |              |                        |                |                     | 16                      | 16              |                     |              |                                |                               |                        |                        |                   |               |                      |                   |                  |                                 |                        |   |                                |                |                             |              |            |
| ZNC__Nico - Maharam [A]                |               |                                     |              |                        |                |                     |                         |                 |                     |              |                                |                               |                        |                        |                   |               |                      |                   |                  |                                 |                        |   |                                |                |                             |              |            |
| 3SU__Summit [N]                        |               |                                     |              |                        |                |                     |                         |                 |                     |              |                                |                               |                        |                        |                   |               |                      |                   |                  |                                 |                        |   |                                |                |                             |              |            |
| <b>Price Category 6</b>                |               |                                     |              |                        |                |                     |                         |                 |                     |              |                                |                               |                        |                        |                   |               |                      |                   |                  |                                 |                        |   |                                |                |                             |              |            |
| 35__ Balance                           |               |                                     |              |                        |                |                     |                         |                 |                     |              |                                |                               |                        |                        |                   |               |                      |                   |                  |                                 |                        |   |                                |                |                             |              |            |
| <b>Price Category 7</b>                |               |                                     |              |                        |                |                     |                         |                 |                     |              |                                |                               |                        |                        |                   |               |                      |                   |                  |                                 |                        |   |                                |                |                             |              |            |
| COL Customer's Own Leather [A]         | 1             |                                     |              |                        |                |                     |                         |                 |                     |              |                                |                               |                        |                        |                   | 8             |                      |                   |                  | 1                               |                        |   |                                |                |                             |              | 1          |
| ZB3__Beck - Maharam [A]                |               |                                     |              |                        |                |                     | 16                      | 16              |                     |              |                                |                               |                        |                        |                   |               |                      |                   |                  |                                 |                        |   |                                |                |                             |              |            |
| 8PV__Mantle - Maharam [A]              |               |                                     |              |                        |                |                     | 16                      | 16              |                     |              |                                |                               |                        |                        |                   |               |                      |                   |                  |                                 |                        |   |                                |                |                             |              |            |
| 5K3__Rowan - Maharam [A]               |               |                                     |              |                        |                |                     | 16                      | 16              |                     |              |                                |                               |                        |                        |                   |               |                      |                   |                  |                                 |                        |   |                                |                |                             |              |            |
| <b>Price Category 8</b>                |               |                                     |              |                        |                |                     |                         |                 |                     |              |                                |                               |                        |                        |                   |               |                      |                   |                  |                                 |                        |   |                                |                |                             |              |            |
| ZLU__Luce - Maharam [A]                |               |                                     |              |                        |                |                     | 16                      | 16              |                     |              |                                |                               |                        |                        |                   |               |                      |                   |                  |                                 |                        |   |                                |                |                             |              |            |
| <b>Price Category 9</b>                |               |                                     |              |                        |                |                     |                         |                 |                     |              |                                |                               |                        |                        |                   |               |                      |                   |                  |                                 |                        |   |                                |                |                             |              |            |
| ZC0__Campana - Maharam [A]             |               |                                     |              |                        |                |                     | 16                      | 16              |                     |              |                                |                               |                        |                        |                   |               |                      |                   |                  |                                 |                        |   |                                |                |                             |              |            |
| ZGE__Gemma - Maharam [A]               |               |                                     |              |                        |                |                     |                         |                 |                     |              |                                |                               |                        |                        |                   |               |                      |                   |                  |                                 |                        |   |                                |                |                             |              |            |
| ZJA__Jasper - Maharam [A]              |               |                                     |              |                        |                |                     | 16                      | 16              |                     |              |                                |                               |                        |                        |                   |               |                      |                   |                  |                                 |                        |   |                                |                |                             |              | 7          |
| Z1__Leather [N]                        | 23            |                                     |              |                        |                |                     |                         |                 |                     |              |                                |                               |                        |                        |                   | 8             |                      |                   |                  |                                 |                        |   |                                |                |                             |              |            |
| <b>Price Category 10</b>               |               |                                     |              |                        |                |                     |                         |                 |                     |              |                                |                               |                        |                        |                   |               |                      |                   |                  |                                 |                        |   |                                |                |                             |              |            |
| 3KH__Firma - Maharam [A]               |               |                                     |              |                        |                |                     | 16                      |                 |                     |              |                                |                               |                        |                        |                   |               |                      |                   |                  |                                 |                        |   |                                |                |                             |              |            |
| ZGF__Gemma Multi - Maharam [A]         |               |                                     |              |                        |                |                     |                         |                 |                     |              |                                |                               |                        |                        |                   |               |                      |                   |                  |                                 |                        |   |                                |                |                             |              |            |
| ZGF__Gemma Multi Reverse - Maharam [A] |               |                                     |              |                        |                |                     |                         |                 |                     |              |                                |                               |                        |                        |                   |               |                      |                   |                  |                                 |                        |   |                                |                |                             |              |            |
| ZP4__Petra - Maharam [A]               |               |                                     |              |                        |                |                     | 16                      | 16              |                     |              |                                |                               |                        |                        |                   |               |                      |                   |                  |                                 |                        |   |                                |                |                             |              |            |
| <b>Price Category 11</b>               |               |                                     |              |                        |                |                     |                         |                 |                     |              |                                |                               |                        |                        |                   |               |                      |                   |                  |                                 |                        |   |                                |                |                             |              |            |
| 3BS__Felix - Maharam [A]               |               |                                     |              |                        |                |                     | 16                      | 16              |                     |              |                                |                               |                        |                        |                   |               |                      |                   |                  |                                 |                        |   |                                |                |                             |              |            |
| <b>Price Category A</b>                |               |                                     |              |                        |                |                     |                         |                 |                     |              |                                |                               |                        |                        |                   |               |                      |                   |                  |                                 |                        |   |                                |                |                             |              |            |
| No fabrics available at this time.     |               |                                     |              |                        |                |                     |                         |                 |                     |              |                                |                               |                        |                        |                   |               |                      |                   |                  |                                 |                        |   |                                |                |                             |              |            |
| <b>Price Category B</b>                |               |                                     |              |                        |                |                     |                         |                 |                     |              |                                |                               |                        |                        |                   |               |                      |                   |                  |                                 |                        |   |                                |                |                             |              |            |
| VM__Medium - Maharam [A]               |               |                                     |              |                        |                |                     |                         |                 |                     |              |                                |                               |                        |                        |                   |               |                      |                   |                  |                                 |                        |   |                                |                |                             |              |            |
| TI__Messenger - Maharam * [A]          |               |                                     |              |                        |                |                     |                         |                 |                     |              |                                |                               |                        |                        |                   |               |                      |                   |                  |                                 |                        |   |                                |                |                             |              |            |
| <b>Price Category C</b>                |               |                                     |              |                        |                |                     |                         |                 |                     |              |                                |                               |                        |                        |                   |               |                      |                   |                  |                                 |                        |   |                                |                |                             |              |            |
| Z27__Manner - Maharam [A]              |               |                                     |              |                        |                |                     |                         |                 |                     |              |                                |                               |                        |                        |                   |               |                      |                   |                  |                                 |                        |   |                                |                |                             |              |            |
| 887__Merit - Maharam [A]               |               |                                     |              |                        |                |                     |                         |                 |                     |              |                                |                               |                        |                        |                   |               |                      |                   |                  |                                 |                        |   |                                |                |                             |              |            |
| Z3__Metric - Maharam [A]               |               |                                     |              |                        |                |                     |                         |                 |                     |              |                                |                               |                        |                        |                   |               |                      |                   |                  |                                 |                        |   |                                |                |                             |              |            |
| 8EY__Murmur - Maharam [A]              |               |                                     |              |                        |                |                     |                         | 16              |                     |              |                                |                               |                        |                        |                   |               |                      |                   |                  |                                 |                        |   |                                |                |                             |              | 7          |
| <b>Price Category D</b>                |               |                                     |              |                        |                |                     |                         |                 |                     |              |                                |                               |                        |                        |                   |               |                      |                   |                  |                                 |                        |   |                                |                |                             |              |            |
| 8I8__Bluff - Maharam [N] [A]           |               |                                     |              |                        |                |                     | 16                      | 16              |                     |              |                                |                               |                        |                        |                   | 8             |                      |                   |                  |                                 | 21                     |   |                                |                |                             |              |            |
| ZMD__Mode - Maharam [A]                |               |                                     |              |                        |                |                     | 18                      |                 |                     |              |                                |                               |                        |                        |                   |               |                      |                   |                  |                                 |                        |   |                                |                |                             |              |            |
| <b>Price Category E</b>                |               |                                     |              |                        |                |                     |                         |                 |                     |              |                                |                               |                        |                        |                   |               |                      |                   |                  |                                 |                        |   |                                |                |                             |              |            |
| ZAT__Article - Maharam [N] [A]         |               |                                     |              |                        |                |                     | 16                      | 16              |                     |              |                                |                               |                        |                        |                   |               |                      |                   |                  |                                 |                        |   |                                |                |                             |              | 7          |

continued on next page

# Textiles Application Chart – Seating continued

• Available

[A] Assigned lead-time textile.

[A] Maharam textiles are on assigned lead times.

[N] Non-woven textile.

See below for exception notes.

|                                     | Aeron® Chairs | Asari Work Chairs by Herman Miller™ | Cosm™ Chairs | Mirra® 2 Chairs/Stools | Embody® Chairs | Fluid Nesting Chairs | Sayl® Work Chairs/Stools | Sayl Side Chairs | Setu® Chairs/Stools | Zeph® Chairs | Verus™ Work Chairs/Stools Back | Verus Work Chairs/Stools Seat | Verus Side Chairs Back | Verus Side Chairs Seat | Verus Plus Chairs | Aside® Chairs | Caper® Chairs/Stools | Lino™ Chairs Back | Lino Chairs Seat | OE1 Storage Trolley Cushion Top | Plex® Lounge Furniture | Swoop™ Lounge Seating - Fully Upholstered | Swoop Lounge Seating - Plywood | Valor™ Seating | Eames® Tandem Sling Seating | Cushion Tops | Workspaces |  |
|-------------------------------------|---------------|-------------------------------------|--------------|------------------------|----------------|----------------------|--------------------------|------------------|---------------------|--------------|--------------------------------|-------------------------------|------------------------|------------------------|-------------------|---------------|----------------------|-------------------|------------------|---------------------------------|------------------------|---|--------------------------------|----------------|-----------------------------|--------------|------------|--|
| <b>Price Category F</b>             |               |                                     |              |                        |                |                      |                          |                  |                     |              |                                |                               |                        |                        |                   |               |                      |                   |                  |                                 |                        |   |                                |                |                             |              |            |  |
| 82T__Apt - Maharam [N] [A]          |               |                                     |              |                        |                |                      | 18                       | •                |                     |              |                                |                               | •                      | •                      |                   |               |                      |                   |                  |                                 |                        |   |                                |                |                             | •            | 7          |  |
| 871__Brindle - Maharam [A]          |               |                                     |              |                        |                |                      | 16                       | 16               |                     |              |                                |                               | •                      | •                      |                   |               | •                    |                   | •                | •                               |                        |   |                                |                |                             | •            | •          |  |
| 87Z__Conduit - Maharam [A]          |               |                                     |              |                        |                |                      | 16                       | 16               |                     |              |                                | •                             | •                      | •                      | •                 |               | •                    |                   | •                | •                               |                        |   |                                |                |                             |              | 7          |  |
| 74M__Instill - Maharam [N] [A]      |               |                                     |              |                        |                |                      | 18                       | 16               |                     |              | •                              | •                             | •                      | •                      |                   |               |                      |                   | •                |                                 | •                      |   | •                              | •              |                             |              | 7          |  |
| 89N__Keen - Maharam [A]             |               |                                     |              |                        |                |                      | 16                       | 16               |                     |              |                                | •                             |                        | •                      | •                 |               |                      |                   | •                |                                 | •                      | •   | •                              |                |                             |              |            |  |
| V9G__Ledger - Maharam [N] [A]       |               |                                     |              |                        |                |                      | 18                       | 16               |                     |              | •                              | •                             | •                      | •                      | •                 |               |                      |                   | •                | •                               |                        | •   | •                              |                | •                           |              | •          |  |
| ZLL__Loop - Maharam [A]             |               |                                     |              |                        |                |                      | 16                       | 16               |                     |              |                                | •                             |                        | •                      |                   |               | 8                    |                   | •                |                                 |                        |   |                                |                | •                           |              |            |  |
| 82A__Multiply - Maharam [A]         |               |                                     |              |                        |                |                      | 16                       | 16               |                     |              | •                              | •                             | •                      | •                      |                   |               | •                    |                   | •                |                                 |                        |   |                                | •              | •                           | •            |            |  |
| 8LW__Pepper - Maharam [A]           |               |                                     |              |                        |                |                      | 16                       | 16               |                     |              |                                | •                             |                        | •                      |                   |               | •                    |                   | •                |                                 | 21                     | •   |                                | 9              |                             |              | •          |  |
| Z33__Strum - Maharam [N] [A]        |               |                                     |              |                        |                |                      | 16                       |                  |                     |              |                                |                               |                        |                        |                   |               |                      |                   |                  |                                 |                        | •   |                                | •              |                             |              | 7          |  |
| <b>Price Category G</b>             |               |                                     |              |                        |                |                      |                          |                  |                     |              |                                |                               |                        |                        |                   |               |                      |                   |                  |                                 |                        |   |                                |                |                             |              |            |  |
| ZC2__Compound - Maharam [N] [A]     |               |                                     |              |                        |                |                      | 16                       | 16               |                     |              | •                              | •                             | •                      | •                      |                   | 8             |                      |                   | •                |                                 | •                      |   | •                              | •              |                             |              | 7          |  |
| ZF1__Fold - Maharam [N] [A]         |               |                                     |              |                        |                |                      | 16                       | 16               |                     |              |                                |                               |                        |                        |                   |               |                      |                   |                  |                                 |                        |   |                                |                | •                           |              | 7          |  |
| 8AR__Gild - Maharam [A]             |               |                                     |              |                        |                |                      | 16                       |                  |                     |              |                                | •                             | •                      | •                      | •                 |               |                      |                   |                  |                                 | 21                     | •   | •                              | •              | •                           |              |            |  |
| ZPR__Pare - Maharam [A]             |               |                                     |              |                        |                |                      | 18                       | 16               |                     |              | •                              |                               | •                      |                        |                   | 8             |                      |                   | •                |                                 | •                      | •   | •                              |                |                             |              | 7          |  |
| ZRF__Runner - Maharam [A]           |               |                                     |              |                        |                |                      | 16                       | 16               |                     |              |                                |                               |                        |                        |                   |               |                      |                   |                  | •                               |                        |   |                                | •              |                             | •            |            |  |
| <b>Price Category H</b>             |               |                                     |              |                        |                |                      |                          |                  |                     |              |                                |                               |                        |                        |                   |               |                      |                   |                  |                                 |                        |   |                                |                |                             |              |            |  |
| ZT__Circles - Maharam [A]           |               |                                     |              |                        |                |                      | 16                       | 16               |                     |              |                                |                               |                        |                        |                   |               |                      |                   |                  |                                 |                        |   |                                |                |                             |              | •          |  |
| ZK__Dot Pattern - Maharam [A]       |               |                                     |              |                        |                |                      | •                        | •                | •                   |              |                                | •                             |                        | •                      |                   |               |                      |                   |                  | •                               |                        |   |                                | •              |                             | •            | •          |  |
| ZL__Small Dot Pattern - Maharam [A] |               |                                     |              |                        |                |                      | •                        | •                | •                   |              |                                | •                             |                        | •                      |                   |               |                      |                   |                  | •                               |                        |   |                                | •              |                             | •            | •          |  |
| <b>Price Category I</b>             |               |                                     |              |                        |                |                      |                          |                  |                     |              |                                |                               |                        |                        |                   |               |                      |                   |                  |                                 |                        |   |                                |                |                             |              |            |  |
| 7CW__Cursive - Maharam [A]          |               |                                     |              |                        |                |                      | 16                       | 16               |                     |              | •                              | •                             | •                      | •                      |                   | 8             |                      |                   | •                | •                               |                        | •   |                                | •              |                             |              | •          |  |
| ZSY__Study - Maharam [A]            |               |                                     |              |                        |                |                      |                          |                  |                     |              |                                |                               |                        |                        |                   |               |                      |                   |                  | •                               |                        |   |                                | •              |                             |              |            |  |
| <b>Price Category J-K</b>           |               |                                     |              |                        |                |                      |                          |                  |                     |              |                                |                               |                        |                        |                   |               |                      |                   |                  |                                 |                        |   |                                |                |                             |              |            |  |
| No fabrics available at this time.  |               |                                     |              |                        |                |                      |                          |                  |                     |              |                                |                               |                        |                        |                   |               |                      |                   |                  |                                 |                        |   |                                |                |                             |              |            |  |
| <b>Price Category L</b>             |               |                                     |              |                        |                |                      |                          |                  |                     |              |                                |                               |                        |                        |                   |               |                      |                   |                  |                                 |                        |   |                                |                |                             |              |            |  |
| ZMK__Minicheck - Maharam [A]        |               |                                     |              |                        |                |                      | •                        | •                |                     |              | •                              | •                             | •                      |                        | •                 |               |                      |                   | •                |                                 |                        |   |                                | •              |                             |              | 7          |  |
| <b>Price Category M</b>             |               |                                     |              |                        |                |                      |                          |                  |                     |              |                                |                               |                        |                        |                   |               |                      |                   |                  |                                 |                        |   |                                |                |                             |              |            |  |
| ZF2__Fruit - Maharam [A]            |               |                                     |              |                        |                |                      | 16                       |                  |                     |              |                                |                               |                        |                        |                   | •             |                      |                   |                  |                                 |                        |   |                                |                |                             |              | 7          |  |
| <b>Price Category N-Q</b>           |               |                                     |              |                        |                |                      |                          |                  |                     |              |                                |                               |                        |                        |                   |               |                      |                   |                  |                                 |                        |   |                                |                |                             |              |            |  |
| No fabrics available at this time.  |               |                                     |              |                        |                |                      |                          |                  |                     |              |                                |                               |                        |                        |                   |               |                      |                   |                  |                                 |                        |   |                                |                |                             |              |            |  |
| <b>Price Category R</b>             |               |                                     |              |                        |                |                      |                          |                  |                     |              |                                |                               |                        |                        |                   |               |                      |                   |                  |                                 |                        |   |                                |                |                             |              |            |  |
| Stow Leather                        |               |                                     |              |                        |                |                      |                          |                  |                     |              | •                              |                               |                        |                        |                   |               |                      |                   |                  |                                 |                        |   |                                |                |                             |              |            |  |
| <b>Price Category S-Z</b>           |               |                                     |              |                        |                |                      |                          |                  |                     |              |                                |                               |                        |                        |                   |               |                      |                   |                  |                                 |                        |   |                                |                |                             |              |            |  |
| No fabrics available at this time.  |               |                                     |              |                        |                |                      |                          |                  |                     |              |                                |                               |                        |                        |                   |               |                      |                   |                  |                                 |                        |   |                                |                |                             |              |            |  |

continued on next page

# Textiles Application Chart — Seating continued

- Available

[A] Assigned lead-time textile.

[A] Maharam textiles are on assigned lead times.

[N] Non-woven textile.

See below for exception notes.

*Application Note: Herman Miller cannot guarantee material/pattern alignment in adjacent products. For example, a fabric's pattern may not align from one pedestal cushion top to the next, or from one chair to another.*

*\* Available in select colors on 20-day lead-time. Refer to "Maharam Colors - Seating" for 20-day colors.*

- |    |  |    |   |
|----|--|----|---|
| 1  | Refer to price book appendices and Omni for COM/COL information.   | 22 | Not available on Sayl side chairs with upholstered backs.                 |
| 7  | Available on 1" Cushion Tops only.                                 | 23 | Available in select colors. Refer to "Textile Colors" for color offering. |
| 8  | Only available on the Aside nonupholstered outer back option (PB). | 24 | Not available on Sayl upholstered High-Back Work Chairs.                  |
| 9  | Available on Valor upholstered seat only.                          | 25 | Not available on Sayl upholstered back work chairs.                       |
| 16 | Available on Sayl Chair seat.                                      | 26 | Available in select colors. Refer to "Textile Colors" for color offering. |
| 18 | Available on Sayl Chair seat and upholstered mid-back.             | 27 | Not available in 3SL15 Carbon Dark.                                       |
| 19 | Available on Sayl seat only.                                       |    |   |
| 20 | Not available on Plex Club Chair with Headrest.                    |    |   |
| 21 | Available on Plex seat and on Ottoman.                             |    |   |

# Textile Colors

## Price Category 1

**Customer's Own Material**  
See Order Information in Appendices. Assigned lead-time textile. [A](#)

**8Z Pellicle®**  
Seating  
For New Aeron® Chairs  
56% elastomeric  
44% polyester  
23101 Mineral  
23102 Carbon  
23103 Graphite

**AireWeave™ 2**  
Seating  
For Mirra® 2 Chairs  
67% elastomeric  
33% antimony-free polyester  
1A701 Alpine  
1A702 Slate Grey  
1A703 Graphite  
1A704 Lime Green  
1A705 Cappuccino  
1A706 Urban Orange  
1A707 Dark Turquoise  
1A708 Twilight

**Chain**  
Workspaces  
66" wide  
100% recycled polyester with 12% ocean bound plastic  
2V01 Pearl  
2V02 Oyster  
2V03 Wheat  
2V04 Linen  
2V05 Wicker  
2V06 Bamboo  
2V07 Sage  
2V08 Spring Wood  
2V09 Iceberg

**Crossing**  
Seating/Workspaces  
54" wide  
86% antimony-free polyester  
14% polyester  
8T03 Wicker \*  
8T04 Porcelain \*  
8T05 Warm Grey \*  
8T10 Tomato  
8T17 Cerulean  
8T18 Indigo  
8T19 Shale \*  
8T22 Tin \*  
8T23 Graphite  
8T24 Black

**Crossing**  
Workspaces  
For workspaces products only.  
54" wide  
86% antimony-free polyester  
14% polyester  
8501 Ivory \*  
8502 Oyster \*

\* Colors available on Exclave®  
Video-friendly Tackable Boards and Stowage Tackable Backdrop

**Dex**  
Ancillary/Seating/Workspaces  
54" wide  
67% recycled polyester  
33% polyester  
3DE01 Frost  
3DE02 Silver Pine  
3DE03 Stone  
3DE04 Shale  
3DE05 Charcoal  
3DE06 Gossamer  
3DE07 Pine

**Duo**  
Seating  
For Lino™ Chairs  
52% polyester  
48% elastomeric  
4RM01 Mineral  
4RM02 Poppy  
4RM03 Green Leaf  
4RM04 Jade  
4RM05 Shadow  
4RM06 Graphite

**Flexnet™**  
Seating  
For Caper® Chairs  
69% elastomeric  
31% polyester  
6V01 Black  
6V02 Silver Grey

**Grasscloth**  
Workspaces  
66" wide  
100% recycled polyester with 11% ocean bound plastic  
2I01 Silver Birch  
2I02 Pampas  
2I03 Sedge  
2I07 Lea  
2I08 Taro  
2I09 Steam Grey  
2I13 Gravel

**Intercept**  
Seating  
For Cosm™ Chairs  
60% elastomeric  
40% polyester  
84501 Graphite  
84502 Carbon  
84503 Mineral  
84504 Nightfall  
84505 Glacier  
84506 Canyon

**Interweave 2**  
Seating  
For Verus™ Chairs  
65% elastomeric  
35% polyester  
36501 Iceberg  
36502 Poppy  
36503 Beachglass  
36504 Blue Grotto  
36505 Slate  
36506 Shale

**Lyris 2™**  
Seating  
For Setu® Chairs  
74% elastomeric  
26% polyester  
4W21 Alpine  
4W23 Chartreuse  
4W25 Berry Blue  
4W26 Slate Grey  
4W28 Chino  
4W31 Graphite

**Monologue**  
Ancillary/Seating/Workspaces  
54" wide  
56% recycled polyester  
44% polyester  
1MN01 Linen  
1MN02 Alabaster  
1MN04 Folkstone  
1MN05 Silver Pine  
1MN06 Slate  
1MN07 Seed  
1MN09 Persimmon  
1MN11 Meadow  
1MN12 Blue Sky  
1MN13 Blue Spruce  
1MN14 Deep Sea

Price category 1 continued on next page

• Maharam textiles are on assigned lead times [A](#).  
• Fabric numbers are listed as Herman Miller fabric number/Maharam fabric number.

# Textile Colors

continued

## Price Category 1

continued

Appendix: Textile Colors

| Resonance      |             |
|----------------|-------------|
| Workspaces     |             |
| 66" wide       |             |
| 100% polyester |             |
| 5T04           | Greige      |
| 5T05           | Porcelain   |
| 5T06           | Alabaster   |
| 5T15           | Iris        |
| 5T28           | Sugar       |
| 5T47           | Tobacco     |
| 5T54           | Saltbush    |
| 5T57           | Seed        |
| 5T58           | Sepia       |
| 5T60           | Iceberg     |
| 5T65           | Red         |
| 5T67           | Boysenberry |
| 5T68           | Pistachio   |
| 5T69           | Green Apple |
| 5T71           | Jade        |
| 5T72           | Blue Green  |
| 5T74           | Twilight    |

| Ripple 3D Knit                  |                    |
|---------------------------------|--------------------|
| Seating                         |                    |
| Available only on Zeph® Chairs. |                    |
| knit to size                    |                    |
| 99% recycled polyester          |                    |
| 1% lycra                        |                    |
| 5H201                           | Black              |
| 5H202                           | Carbon             |
| 5H203                           | Alpine             |
| 5H204                           | Silt               |
| 5H205                           | Tea Rose           |
| 5H206                           | Cocoa              |
| 5H207                           | Persimmon          |
| 5H208                           | Blaze              |
| 5H209                           | Cayenne            |
| 5H210                           | Falcon             |
| 5H211                           | Mustard Seed       |
| 5H212                           | Patina             |
| 5H213                           | Olive              |
| 5H214                           | Moss               |
| 5H215                           | Aloe               |
| 5H216                           | Glacier            |
| 5H217                           | Ultramarine        |
| 5H218                           | Nightfall          |
| 5H219                           | Bluebell           |
| 5H220                           | Boysenberry        |
| 5H221                           | Nightfall/Bluebell |
| 5H222                           | Patina/Alpine      |
| 5H223                           | Cayenne/Glacier    |
| 5H224                           | Tea Rose/Olive     |
| 5H225                           | Silt/Blaze         |

| Scatter  |            |
|--|------------|
| Ancillary/Seating/Workspaces                             |            |
| 54" wide   |            |
| 100% recycled polyester,<br>with 26% ocean bound plastic |            |
| 4SC01  | Alpine     |
| 4SC02  | Fog        |
| 4SC03  | Shale      |
| 4SC04  | Persimmon  |
| 4SC07  | Olive      |
| 4SC08  | Glacier    |
| 4SC09  | Blue Sky   |
| 4SC10  | Lagoon     |
| 4SC11  | Slate Grey |
| 4SC12  | Blue Black |

| Scribe  |             |
|---|-------------|
| Seating/Workspaces                                      |             |
| 54" wide  |             |
| 100% recycled polyester<br>with 53% ocean bound plastic |             |
| 3DN01   | Spring Wood |
| 3DN02   | Poplar      |
| 3DN03   | Pewter      |
| 3DN04   | Deep Sea    |
| 3DN05   | Fir         |
| 3DN06   | Nutmeg      |

| Slant                                   |              |
|---|--------------|
| Workspaces                              |              |
| 66" wide                                |              |
| 51% polyester<br>49% recycled polyester |              |
| 22F04                                   | Pesto        |
| 22F06                                   | Neptune      |
| 22F07                                   | Blueberry    |
| 22F10                                   | Pumpkin      |
| 22F12                                   | Silver Birch |
| 22F13                                   | Bluestone    |
| 22F15                                   | Shale        |

| Splash 3D Knit                  |              |
|---------------------------------|--------------|
| Seating                         |              |
| Available only on Zeph® Chairs. |              |
| knit to size                    |              |
| 98% recycled polyester          |              |
| 2% lycra                        |              |
| 5H101                           | Black        |
| 5H102                           | Carbon       |
| 5H103                           | Alpine       |
| 5H104                           | Silt         |
| 5H105                           | Tea Rose     |
| 5H106                           | Cocoa        |
| 5H107                           | Persimmon    |
| 5H108                           | Blaze        |
| 5H109                           | Cayenne      |
| 5H110                           | Falcon       |
| 5H111                           | Mustard Seed |
| 5H112                           | Patina       |
| 5H113                           | Olive        |
| 5H114                           | Moss         |
| 5H115                           | Aloe         |
| 5H116                           | Glacier      |
| 5H117                           | Ultramarine  |
| 5H118                           | Nightfall    |
| 5H119                           | Bluebell     |
| 5H120                           | Boysenberry  |

| Stretch Knit                             |             |
|--|-------------|
| Seating                                  |             |
| Assigned lead-time textile. <sup>A</sup> |             |
| Available only on Say®                   |             |
| Suspension Back Work Chairs              |             |
| 97% polyester, 3% spandex                |             |
| 3DK01                                    | Fog         |
| 3DK02                                    | Slate Grey  |
| 3DK03                                    | Java        |
| 3DK04                                    | Black       |
| 3DK05                                    | Red         |
| 3DK06                                    | Green Apple |
| 3DK07                                    | Berry Blue  |

Price category 1 continued on next page

- Maharam textiles are on assigned lead times <sup>A</sup>.
- Fabric numbers are listed as Herman Miller fabric number/Maharam fabric number.

# Textile Colors

continued

## Price Category 1

continued

| Tailored  |                   |
|---|-------------------|
| Ancillary/Seating/Workspaces<br>54" wide<br>56% polyester<br>44% recycled polyester |                   |
| 23501   | Studio White * ** |
| 23502   | Sugar *           |
| 23503   | Tomato            |
| 23506   | Chive             |
| 23508   | Cobalt            |
| 23509   | Cadet             |
| 23510   | Fog               |
| 23511   | Graphite          |
| 23512   | Black             |
| 23513   | Coffee            |

\* Colors not available on Plex™ Lounge Furniture.  
\*\* Color not available on Canvas Tiles.

| Tuck 3D Knit   |           |
|--|-----------|
| Seating<br>Available only on Fuld Nesting Chairs.<br>knit to size<br>56% polyester<br>44% recycled polyester |           |
| 9NK01  | Alpine    |
| 9NK02  | Carbon    |
| 9NK03  | Nightfall |
| 9NK04  | Olive     |
| 9NK05  | Cocoa     |
| 9NK06  | Canyon    |

| Whisper   |              |
|---|--------------|
| Ancillary/Seating/Workspaces<br>54" wide<br>73% recycled polyester<br>27% polyester<br>with 11.3% ocean bound plastic |              |
| 1WS01   | Sand Dollar  |
| 1WS02   | Pebble       |
| 1WS03   | Silver Birch |
| 1WS04   | Iceberg      |
| 1WS05   | Silver Pine  |
| 1WS06   | Carbon       |
| 1WS07   | Cumin        |
| 1WS12   | Willow       |
| 1WS13   | Sea Grass    |
| 1WS14   | Pool         |
| 1WS15   | Blueberry    |
| 1WS16   | Glacier      |
| 1WS17   | Grey         |
| 1WS18   | Canyon       |

## Price Category 2

| Aristo   |               |
|--|---------------|
| Ancillary/Seating/Workspaces<br>54" wide<br>88% recycled polyester<br>12% polyester<br>Acrylic backing |               |
| 3AR01  | Forest Moss   |
| 3AR02  | Light Brindle |
| 3AR03  | Mink          |
| 3AR04  | Copper        |
| 3AR05  | Adobe         |
| 3AR06  | Cherry        |
| 3AR07  | Lilac         |
| 3AR08  | Green Apple   |
| 3AR09  | Surf          |
| 3AR10  | Waterfall     |
| 3AR11  | Cadet         |
| 3AR12  | Tin           |
| 3AR13  | Pewter        |
| 3AR14  | Grey Brindle  |
| 3AR15  | Grey Black    |

| Cord   |              |
|--|--------------|
| Workspaces<br>66" wide<br>51% antimony-free polyester<br>49% polyester |              |
| 5101   | Ivory        |
| 5102   | White Ash    |
| 5103   | Linen        |
| 5104   | Bamboo       |
| 5105   | Sepia        |
| 5107   | Sesame       |
| 5109   | Bayou        |
| 5111   | Spring Wood  |
| 5112   | Summer White |

| Crepe  |            |
|--|------------|
| Ancillary/Seating/Workspaces<br>54" wide<br>100% recycled polyester,<br>with 43.6% ocean bound plastic |            |
| 9201   | Licorice   |
| 9203   | Smoke      |
| 9207   | Cherry     |
| 9223   | Cadet      |
| 9241   | Beachglass |
| 9249   | Stone *    |
| 9251   | Fog *      |
| 9252   | Slate Grey |
| 9261   | Shale      |
| 9262   | Graphite   |
| 9265   | Mineral    |
| 9266   | Persimmon  |
| 9267   | Juniper    |
| 9268   | Glacier    |
| 9269   | Cascade    |
| 9270   | Navy       |

\* Colors available on Exclave® Video-friendly Tackable Boards and Stowage Tackable Backdrop.

Price category 2 continued on next page

- Maharam textiles are on assigned lead times <sup>A</sup>.
- Fabric numbers are listed as Herman Miller fabric number/Maharam fabric number.

# Textile Colors

continued

## Price Category 2

continued

Appendix: Textile Colors

| Epic                         |              |
|------------------------------|--------------|
| Ancillary/Seating/Workspaces |              |
| 54" wide                     |              |
| 56% recycled polyester       |              |
| 44% polyester                |              |
| Acrylic backing              |              |
| 3EP01                        | Alabaster    |
| 3EP02                        | Smoke        |
| 3EP03                        | Falcon       |
| 3EP05                        | Copper       |
| 3EP06                        | Urban Orange |
| 3EP07                        | Poppy        |
| 3EP10                        | Clover       |
| 3EP11                        | Loden        |
| 3EP14                        | Peacock      |
| 3EP15                        | Cadet        |
| 3EP16                        | Indigo       |
| 3EP17                        | Spring Wood  |
| 3EP18                        | Grey Brindle |
| 3EP19                        | Seed         |
| 3EP20                        | Carbon Dark  |

| Hint                         |           |
|------------------------------|-----------|
| Ancillary/Seating/Workspaces |           |
| 54" wide                     |           |
| 76% recycled polyester       |           |
| 24% polyester                |           |
| 3DP01                        | Sediment  |
| 3DP02                        | Gunmetal  |
| 3DP03                        | Silt      |
| 3DP04                        | Porcelain |
| 3DP05                        | Indigo    |
| 3DP06                        | Fern      |
| 3DP07                        | Adobe     |
| 3DP08                        | Red Sea   |

| Horizon                     |             |
|-----------------------------|-------------|
| Workspaces                  |             |
| 54" wide                    |             |
| 65% antimony-free polyester |             |
| 35% polyester               |             |
| 4N01                        | Rye Grass   |
| 4N02                        | Sugar Pine  |
| 4N03                        | Silver Pine |
| 4N04                        | White Ash   |
| 4N05                        | Spring Wood |
| 4N08                        | Haystack    |
| 4N09                        | Oat Grass   |
| 4N13                        | Pine Cone   |
| 4N15                        | Elderberry  |

| Marvel                              |                |
|-------------------------------------|----------------|
| Ancillary/Seating                   |                |
| 54" wide                            |                |
| 100% pvc-free polyurethane          |                |
| antimicrobial, antibacterial finish |                |
| 1MV01                               | Summer White   |
| 1MV02                               | Sand Dollar    |
| 1MV03                               | Espresso       |
| 1MV04                               | Folkstone Grey |
| 1MV05                               | Graphite       |
| 1MV06                               | Onyx           |
| 1MV07                               | Polar Blue     |
| 1MV08                               | Blush Grey     |
| 1MV12                               | Red            |
| 1MV14                               | Pine           |
| 1MV15                               | Teal Green     |
| 1MV16                               | Twilight       |

| Medley                       |                |
|------------------------------|----------------|
| Ancillary/Seating/Workspaces |                |
| 54" wide                     |                |
| 100% polyester               |                |
| 1HA01                        | Stone *        |
| 1HA02                        | Trail          |
| 1HA03                        | Charcoal       |
| 1HA04                        | Cinder         |
| 1HA07                        | Chutney        |
| 1HA09                        | Feather Grey * |
| 1HA11                        | Loden          |
| 1HA13                        | Bayou *        |
| 1HA14                        | Blue Grotto    |
| 1HA15                        | Blueberry      |
| 1HA22                        | Khaki          |
| 1HA23                        | Pewter         |
| 1HA24                        | Yellow Oxide   |
| 1HA25                        | Vintage Rose   |
| 1HA26                        | Raspberry      |
| 1HA27                        | Acai Berry     |

\* Colors available on Exclave®  
Video-friendly Tackable Boards  
and Stowage Tackable Backdrop

| Mellow   |           |
|--|-----------|
| Ancillary/Seating/Workspaces                             |           |
| 54" wide   |           |
| 100% recycled polyester,<br>with 16% ocean bound plastic |           |
| 4ME01  | Mineral   |
| 4ME04  | Olive     |
| 4ME05  | Glacier   |
| 4ME06  | Oceanside |
| 4ME07  | Charcoal  |

| Metaphor – Maharam           |                |
|------------------------------|----------------|
| Ancillary/Seating/Workspaces |                |
| 54" wide                     |                |
| 100% polyester               |                |
| Acrylic backing              |                |
| ZMA01/466553-001             | Afterfeather * |
| ZMA02/466553-002             | Moonflower     |
| ZMA03/466553-003             | Handcraft      |
| ZMA04/466553-004             | Crossroad      |
| ZMA05/466553-005             | Chondrite      |
| ZMA06/466553-006             | Detective      |
| ZMA07/466553-007             | Steamship      |
| ZMA08/466553-008             | Electricity    |
| ZMA09/466553-009             | Takeoff        |
| ZMA10/466553-010             | Parachute      |
| ZMA11/466553-011             | Blueshift      |
| ZMA12/466553-012             | Dockyard       |
| ZMA13/466553-013             | Bathe          |
| ZMA14/466553-014             | Icebound       |
| ZMA15/466553-015             | Thermosphere   |
| ZMA16/466553-016             | Aboard         |
| ZMA17/466553-017             | Agaware        |
| ZMA18/466553-018             | Homeland       |
| ZMA19/466553-019             | Rockfall       |
| ZMA20/466553-020             | Undergrowth    |
| ZMA21/466553-021             | Gremolata      |
| ZMA22/466553-022             | Patina         |
| ZMA23/466553-023             | Sylvan         |
| ZMA24/466553-024             | Outfield       |
| ZMA25/466553-025             | Windbreak      |
| ZMA26/466553-026             | Saguaro        |

Price category 2 continued on  
next page

- Maharam textiles are on assigned lead times [A](#).
- Fabric numbers are listed as Herman Miller fabric number/Maharam fabric number.



# Textile Colors

continued

## Price Category 2

continued

### Metaphor continued

|                  |             |
|------------------|-------------|
| ZMA27/466553-027 | Barnwood    |
| ZMA28/466553-028 | Cookshop    |
| ZMA29/466553-029 | Amandine    |
| ZMA30/466553-030 | Bodhran     |
| ZMA31/466553-031 | Centerstage |
| ZMA32/466553-032 | Focaccia    |
| ZMA33/466553-033 | Bumblebee   |
| ZMA34/466553-034 | Microbrew   |
| ZMA35/466553-035 | Sauna       |
| ZMA36/466553-036 | Gazebo      |
| ZMA37/466553-037 | Pirouette   |
| ZMA38/466553-038 | Heartbeat   |
| ZMA39/466553-039 | Shino       |
| ZMA40/466553-040 | Sunrise     |
| ZMA41/466553-041 | Florist     |
| ZMA42/466553-042 | Beadwork    |
| ZMA43/466553-043 | Framboise   |
| ZMA44/466553-044 | Wisteria    |
| ZMA45/466553-045 | Warrior     |

\* Colors not available on Eames Aluminum Group, Soft Pad, Sofa Compact, Molded Fiberglass/Plastic Chairs, Task Chair, Wire Chairs, Nelson Platform Bench Cushion, Swoop Plywood Lounge Chair.

### Muse – Maharam

|                                       |             |
|---------------------------------------|-------------|
| Ancillary/Seating/Workspaces          |             |
| 54" wide                              |             |
| 100% post-consumer recycled polyester |             |
| 8I101/466487-001                      | Crescendo   |
| 8I102/466487-002                      | Resonate    |
| 8I103/466487-003                      | Runway      |
| 8I104/466487-004                      | Ascend      |
| 8I105/466487-005                      | Veil *      |
| 8I106/466487-006                      | Refresh *   |
| 8I107/466487-007                      | Clear *     |
| 8I108/466487-008                      | Fantasy     |
| 8I109/466487-009                      | Miso        |
| 8I110/466487-010                      | Compass     |
| 8I111/466487-011                      | Bergamot *  |
| 8I112/466487-012                      | Grasshopper |

### Muse continued

|                  |            |
|------------------|------------|
| 8I113/466487-013 | Goal       |
| 8I114/466487-014 | Mistletoe  |
| 8I115/466487-015 | Seaglass * |
| 8I116/466487-016 | Frigid     |
| 8I117/466487-017 | Riverbend  |
| 8I118/466487-018 | Noble      |
| 8I119/466487-019 | Pulsar     |
| 8I120/466487-020 | Velella    |
| 8I121/466487-021 | Sailboat   |
| 8I122/466487-022 | Sparse     |
| 8I123/466487-023 | Vase       |
| 8I124/466487-024 | Haven      |
| 8I125/466487-025 | Mead       |
| 8I126/466487-026 | Neat       |
| 8I127/466487-027 | Jovial     |
| 8I128/466487-028 | Theater    |
| 8I129/466487-029 | Poinsettia |
| 8I130/466487-030 | Celebrate  |
| 8I131/466487-031 | Spectacle  |

\* Colors not available on Valor Seating.

### Rhythm

|                   |             |
|-------------------|-------------|
| Ancillary/Seating |             |
| 54" wide          |             |
| 100% polyester    |             |
| 3002              | Green Apple |
| 3004              | Bayou       |
| 3005              | Berry Blue  |
| 3006              | Iris        |
| 3007              | Twilight    |
| 3009              | Poppy       |
| 3010              | Molasses    |
| 3012              | Khaki       |
| 3013              | Mink        |
| 3014              | Black *     |
| 3015              | Charcoal *  |

\* Colors available on Embody® Chair.

### Sequel

|                              |             |
|------------------------------|-------------|
| Ancillary/Seating/Workspaces |             |
| 54" wide                     |             |
| 100% vinyl                   |             |
| 100% polyester knit backing  |             |
| Resilience® finish           |             |
| 3SL01                        | White       |
| 3SL02                        | Pebble      |
| 3SL03                        | Mushroom    |
| 3SL04                        | Stone       |
| 3SL06                        | Rattan      |
| 3SL09                        | Seal        |
| 3SL10                        | Blue Fog    |
| 3SL11                        | Folkstone   |
| 3SL12                        | Shale       |
| 3SL13                        | Slate Grey  |
| 3SL14                        | Charcoal    |
| 3SL15                        | Carbon Dark |
| 3SL28                        | Navy *      |

\* Color available on Eames® Tandem Sling Seating.

### Terra

|   |             |
|---|-------------|
| Ancillary/Seating/Workspaces                          |             |
| 54" wide  |             |
| 100% post-consumer recycled biodegradable polyester * |             |
| 4TE01   | Spring Wood |
| 4TE02   | Zinc        |
| 4TE03   | Pine Cone   |
| 4TE04   | Charcoal    |

\* 1% biodegradation in 1,278 days under ASTM D5511 conditions. No evidence of further degradation.

### Twine

|                         |              |
|-------------------------|--------------|
| Workspaces              |              |
| 66" wide                |              |
| 100% recycled polyester |              |
| 3TW01                   | Silver Birch |
| 3TW02                   | Ivory        |
| 3TW03                   | Alabaster    |
| 3TW04                   | Bamboo       |
| 3TW05                   | Iceberg      |
| 3TW06                   | Charcoal     |
| 3TW07                   | Feather Grey |
| 3TW08                   | Shale        |

### Twist

|                              |               |
|------------------------------|---------------|
| Ancillary/Seating/Workspaces |               |
| 54" wide                     |               |
| 80% antimony-free polyester  |               |
| 13% recycled polyester       |               |
| 7% polyester                 |               |
| 8R05                         | Wicker        |
| 8R10                         | Poppy         |
| 8R14                         | Tin           |
| 8R15                         | Shale         |
| 8R16                         | Graphite      |
| 8R17                         | Birch         |
| 8R18                         | Sepia         |
| 8R22                         | Blueberry     |
| 8R23                         | Green Apple   |
| 8R26                         | Gunmetal      |
| 8R27                         | Cinder        |
| 8R29                         | Pekoe         |
| 8R33                         | Forest        |
| 8R35                         | Waterfall     |
| 8R36                         | Midnight Blue |
| 8R37                         | Carbon Dark   |

### Twist

|                               |        |
|-------------------------------|--------|
| Workspaces                    |        |
| For workspaces products only. |        |
| 54" wide                      |        |
| 80% antimony-free polyester   |        |
| 13% recycled polyester        |        |
| 7% polyester                  |        |
| 5S03                          | Oyster |

- Maharam textiles are on assigned lead times [A](#).
- Fabric numbers are listed as Herman Miller fabric number/Maharam fabric number.

# Textile Colors

continued

## Price Category 3

Appendix: Textile Colors

| Ace                    |              |
|------------------------|--------------|
| Ancillary/Seating      |              |
| 54" wide               |              |
| 100% polyurethane      |              |
| Polyester knit backing |              |
| Stain resistant finish |              |
| 3AC01                  | Summer White |
| 3AC02                  | White Ash    |
| 3AC03                  | Rye          |
| 3AC04                  | Metal        |
| 3AC05                  | Clay         |
| 3AC06                  | Chestnut     |
| 3AC08                  | Camelback    |
| 3AC09                  | Chipotle     |
| 3AC12                  | Artichoke    |
| 3AC13                  | Sepia Dark   |
| 3AC14                  | Aloe         |
| 3AC15                  | Flint        |
| 3AC16                  | Blue Sky     |
| 3AC17                  | Oceanside    |
| 3AC18                  | Midnight     |
| 3AC20                  | Frost        |
| 3AC21                  | Lead         |
| 3AC22                  | Black        |

| Fractal                      |              |
|------------------------------|--------------|
| Ancillary/Seating/Workspaces |              |
| 58" wide                     |              |
| 84% recycled polyester       |              |
| 16% polyester                |              |
| 43Z01                        | Granite      |
| 43Z02                        | Golden Olive |
| 43Z03                        | Verdant      |
| 43Z04                        | Cadet        |

| Ground Cloth®  |               |
|----------------|---------------|
| Workspaces     |               |
| 66" wide       |               |
| 100% polyester |               |
| 4701           | Vapor Grey    |
| 4721           | Warm White *  |
| 4722           | Fog *         |
| 4723           | Straw *       |
| 4724           | Red Orange *  |
| 4726           | Green Apple * |
| 4727           | Caribbean *   |
| 4728           | Midnight *    |
| 4729           | Cappuccino *  |

\* Colors available on Exclave®  
Video-friendly Tackable Boards  
and Stowage Tackable Backdrop

| Latitude                  |              |
|---------------------------|--------------|
| Seating                   |              |
| Colors for Mirra 2 Chairs |              |
| 100% polyester            |              |
| 8M10                      | Alpine       |
| 8M17                      | Black        |
| 8M23                      | French Press |
| 8M27                      | Cordovan     |
| 8M28                      | Ochre        |
| 8M28                      | Ultramarine  |
| 8M28                      | Olive        |

| Meld – Maharam                       |           |
|--------------------------------------|-----------|
| Ancillary/Seating/Workspaces         |           |
| 54" wide                             |           |
| 68% post-consumer recycled polyester |           |
| 32% polyester                        |           |
| PFOA-Free stain resistant            |           |
| ZM201/466387-201                     | Vast      |
| ZM202/466387-202                     | Panda **  |
| ZM203/466387-203                     | Skyline * |
| ZM204/466387-204                     | Knight ** |
| ZM205/466387-205                     | Quill **  |
| ZM206/466387-206                     | Pipe      |
| ZM207/466387-207                     | Grate *   |
| ZM208/466387-208                     | Gloss     |

| Meld continued   |             |
|------------------|-------------|
| ZM209/466387-209 | Bulb        |
| ZM210/466387-210 | Bride       |
| ZM211/466387-211 | Stark       |
| ZM212/466387-212 | Seashell    |
| ZM213/466387-213 | Antler      |
| ZM214/466387-214 | Crater *    |
| ZM215/466387-215 | Perennial   |
| ZM216/466387-216 | Mulberry    |
| ZM217/466387-217 | Fuchsia *   |
| ZM218/466387-218 | Amethyst *  |
| ZM219/466387-219 | Merlot      |
| ZM220/466387-220 | Magma *     |
| ZM221/466387-221 | Rooster     |
| ZM222/466387-222 | Heat *      |
| ZM223/466387-223 | Clementine  |
| ZM224/466387-224 | Fox         |
| ZM225/466387-225 | Kiss *      |
| ZM226/466387-226 | Bare        |
| ZM227/466387-227 | Blonde      |
| ZM228/466387-228 | Mimosa      |
| ZM229/466387-229 | Comet *     |
| ZM230/466387-230 | Honeydew    |
| ZM231/466387-231 | Wild *      |
| ZM232/466387-232 | Vine        |
| ZM233/466387-233 | Seed        |
| ZM234/466387-234 | Kale *      |
| ZM235/466387-235 | Waterfall * |
| ZM236/466387-236 | Nordic *    |
| ZM237/466387-237 | Reef *      |
| ZM238/466387-238 | Wave        |
| ZM239/466387-239 | Isle **     |
| ZM240/466387-240 | Creek       |
| ZM241/466387-241 | Mariner *   |
| ZM242/466387-242 | Globe       |
| ZM243/466387-243 | Spa         |

\* Colors available on  
20-day lead time.

\*\* Colors available on  
10-day lead time.

| Parcel                       |              |
|------------------------------|--------------|
| Ancillary/Seating/Workspaces |              |
| 54" wide                     |              |
| 100% recycled polyester      |              |
| 4GE01                        | Gunmetal     |
| 4GE02                        | Brindle      |
| 4GE03                        | Bayou        |
| 4GE04                        | Pesto        |
| 4GE05                        | Golden Olive |
| 4GE06                        | Copper Sea   |

| Saille - Geiger Textile          |               |
|----------------------------------|---------------|
| Ancillary                        |               |
| 57" wide                         |               |
| 69% cotton                       |               |
| 31% polyester                    |               |
| PFOA-Free stain resistant finish |               |
| Acrylic backing                  |               |
| 18001                            | Coal          |
| 18002                            | Shale         |
| 18003                            | Haze          |
| 18004                            | Stone         |
| 18005                            | White *       |
| 18006                            | Beach         |
| 18007                            | Sand          |
| 18008                            | Blush         |
| 18009                            | Brick         |
| 18010                            | Fog           |
| 18011                            | Celadon       |
| 18012                            | Poolside      |
| 18013                            | Summer Sky    |
| 18014                            | Lake          |
| 18015                            | Midnight Blue |

\* Color not available on Eames®  
Soft Pad Group Chairs/Ottomans.

Price category 3 continued on  
next page

- Maharam textiles are on assigned lead times [A](#).
- Fabric numbers are listed as Herman Miller fabric number/Maharam fabric number.

# Textile Colors

continued

## Price Category 3

continued

| Strands                 |           |
|-------------------------|-----------|
| Workspaces              |           |
| 66" wide                |           |
| 100% recycled polyester |           |
| 8W01                    | Pebble    |
| 8W02                    | Porcelain |
| 8W03                    | Taupe     |
| 8W04                    | Honey     |
| 8W05                    | Khaki     |
| 8W06                    | Rye       |
| 8W07                    | Wicker    |
| 8W08                    | Tin       |
| 8W09                    | Cool Grey |

## Price Category 4

| Cygnus                           |        |
|----------------------------------|--------|
| Ancillary                        |        |
| For Eames® Aluminum Group Chairs |        |
| 69% elastomeric                  |        |
| 31% polyester                    |        |
| 5401                             | Black  |
| 5402                             | Zinc   |
| 5403                             | Quartz |

| Daydream                     |              |
|------------------------------|--------------|
| Ancillary/Seating/Workspaces |              |
| 54" wide                     |              |
| 48% wool                     |              |
| 41% recycled polyester       |              |
| 9% nylon                     |              |
| 2% polyester                 |              |
| 3DM01                        | Rye Grass    |
| 3DM02                        | Silver Birch |
| 3DM03                        | Pewter       |
| 3DM04                        | Graphite     |
| 3DM05                        | Black        |
| 3DM06                        | Lemongrass   |
| 3DM07                        | Permission   |
| 3DM08                        | Juniper      |
| 3DM09                        | Sea Grass    |
| 3DM10                        | Nightfall    |

| Hush          |            |
|---------------|------------|
| Workspaces    |            |
| 66" wide      |            |
| 80% polyester |            |
| 20% viscose   |            |
| 1HS01         | Canyon     |
| 1HS02         | Pesto      |
| 1HS03         | Bayou      |
| 1HS04         | Greystone  |
| 1HS05         | Charcoal   |
| 1HS06         | Rye Grass  |
| 1HS07         | Cool Grey  |
| 1HS08         | Dark Grey  |
| 1HS09         | Aqua Green |
| 1HS10         | Nightfall  |

| Kalista - Geiger Textile               |              |
|--|--------------|
| Ancillary                              |              |
| 54" wide                               |              |
| 71% post-industrial recycled cotton    |              |
| 18% post-industrial recycled polyester |              |
| 11% polyester                          |              |
| PFOA-Free stain resistant finish       |              |
| 1AL01                                  | Cotton       |
| 1AL02                                  | Natural      |
| 1AL03                                  | Titanium     |
| 1AL04                                  | Pewter       |
| 1AL05                                  | Starry Night |
| 1AL06                                  | Red Hot      |
| 1AL07                                  | Sun Kissed   |
| 1AL08                                  | Dune         |
| 1AL09                                  | Beach Glass  |
| 1AL10                                  | Bluestone    |
| 1AL11                                  | Seaside      |
| 1AL12                                  | Night Sky    |

| Lariat - Maharam  |     |
|-------------------|-----|
| Ancillary/Seating |     |
| 54" wide          |     |
| 100% vinyl        |     |
| ZLR01/440401-001  | 001 |
| ZLR02/440401-002  | 002 |
| ZLR04/440401-004  | 004 |
| ZLR06/440401-006  | 006 |
| ZLR07/440401-007  | 007 |
| ZLR08/440401-008  | 008 |
| ZLR10/440401-010  | 010 |
| ZLR11/440401-011  | 011 |
| ZLR13/440401-013  | 013 |
| ZLR14/440401-014  | 014 |
| ZLR15/440401-015  | 015 |
| ZLR16/440401-016  | 016 |
| ZLR18/440401-018  | 018 |
| ZLR20/440401-020  | 020 |
| ZLR21/440401-021  | 021 |
| ZLR24/440401-024  | 024 |
| ZLR25/440401-025  | 025 |
| ZLR26/440401-026  | 026 |

| Lariat continued |           |
|------------------|-----------|
| ZLR28/440401-028 | 028       |
| ZLR31/440401-031 | 031       |
| ZLR32/440401-032 | 032       |
| ZLR33/440401-033 | 033       |
| ZLR34/440401-034 | 034       |
| ZLR38/440401-038 | 038       |
| ZLR39/440401-039 | Granite   |
| ZLR40/440401-040 | Linen     |
| ZLR41/440401-041 | Stella    |
| ZLR42/440401-042 | Saddle    |
| ZLR43/440401-043 | Holly     |
| ZLR44/440401-044 | Maroon    |
| ZLR45/440401-045 | Siren     |
| ZLR46/440401-046 | Reseda    |
| ZLR47/440401-047 | Purslane  |
| ZLR48/440401-048 | Spire     |
| ZLR49/440401-049 | Papyrus   |
| ZLR50/440401-050 | Chickadee |
| ZLR51/440401-051 | Requiem   |

| Sync              |              |
|-------------------|--------------|
| Ancillary/Seating |              |
| 55" wide          |              |
| 100% polyester    |              |
| 3SY01             | Pine Cone    |
| 3SY03             | Canyon       |
| 3SY04             | Truffle      |
| 3SY06             | Everglade    |
| 3SY08             | Nightfall    |
| 3SY09             | Dark Mineral |
| 3SY10             | Slate Grey   |
| 3SY11             | Dark Carbon  |
| 3SY12             | Black        |

Appendix: Textile Colors

- Maharam textiles are on assigned lead times [A](#).
- Fabric numbers are listed as Herman Miller fabric number/Maharam fabric number.

# Textile Colors

continued

## Price Category 5

Appendix: Textile Colors

| Arlo - Maharam            |  | Hopsak                           |  | Method - Maharam             |  | Nico - Maharam               |  |
|---------------------------|--|----------------------------------|--|------------------------------|--|------------------------------|--|
| Ancillary/Seating         |  | Ancillary/Seating/Workspaces     |  | Ancillary/Seating/Workspaces |  | Ancillary/Seating/Workspaces |  |
| 70% wool                  |  | 56" wide                         |  | 54" wide                     |  | 54" wide                     |  |
| 30% polyester             |  | 100% recycled polyester          |  | 100% recycled polyester      |  | 63% wool                     |  |
| 5YT01 Turn                |  | 14A20 Black                      |  | with 9% ocean-bound plastic  |  | 21% polyester                |  |
| 5YT02 Embers              |  | 14A22 Raw Umber Dark             |  | 40G01/466579-001 Inspire     |  | 16% solution-dyed nylon      |  |
| 5YT03 Parallel            |  | 14A26 Grey Blue Dark             |  | 40G02/466579-002 Rhea        |  | ZNC01/466564-001 Alcazar     |  |
| 5YT04 Octave              |  | 14A30 Sepia Dark                 |  | 40G03/466579-003 Noise       |  | ZNC02/466564-002 Ironclad    |  |
| 5YT05 Musing              |  | 14A38 Emerald Dark               |  | 40G04/466579-004 Speedway    |  | ZNC03/466564-003 Tune        |  |
| 5YT06 Summon              |  | 14A39 Yellow Dark                |  | 40G05/466579-005 Villanelle  |  | ZNC04/466564-004 Bridegroom  |  |
| 5YT07 Dynamic             |  | 14A40 Orange                     |  | 40G06/466579-006 Maestro     |  | ZNC05/466564-005 Diode       |  |
| 5YT08 Signals             |  | 14A41 Sienna                     |  | 40G07/466579-007 Destiny     |  | ZNC06/466564-006 Jest        |  |
| 5YT09 Aspect              |  | 14A42 Olive Green Dark           |  | 40G08/466579-008 Possess     |  | ZNC07/466564-007 Sanctuary   |  |
| 5YT10 Dedicate            |  | 14A43 Crimson                    |  | 40G09/466579-009 Waterside   |  | ZNC08/466564-008 Aquarius    |  |
| 5YT11 Juniper             |  | 14A44 Crimson Dark Dark          |  | 40G10/466579-010 Relax       |  | ZNC09/466564-009 Houseboat   |  |
| 5YT12 Cilantro            |  | 14A45 Violet Dark                |  | 40G11/466579-011 Delightful  |  | ZNC10/466564-010 Olympian    |  |
| 5YT13 Hawthorn            |  | 14A46 Pink Dark Dark             |  | 40G12/466579-012 Parrotlet   |  | ZNC11/466564-011 Tennis      |  |
| 5YT14 Thread              |  | 14A47 Ultramarine Dark           |  | 40G13/466579-013 Verdurous   |  | ZNC12/466564-012 Dressage    |  |
| 5YT15 Spalted             |  | 14A48 Cobalt Blue                |  | 40G14/466579-014 Bosky       |  | ZNC13/466564-013 Zing        |  |
| 5YT16 Warmer              |  | 14A49 Terra Cotta                |  | 40G15/466579-015 Acreage     |  | ZNC14/466564-014 Bitterroot  |  |
| 5YT17 Misted              |  | 14A50 Ochre Dark                 |  | 40G16/466579-016 Allude      |  | ZNC15/466564-015 Gemini      |  |
| 5YT18 Share               |  |                                  |  | 40G17/466579-017 Tweed       |  | ZNC16/466564-016 Posh        |  |
| 5YT19 Chord               |  | <b>Ingenu - Geiger Textile</b>   |  | 40G18/466579-018 Korma       |  | ZNC17/466564-017 Sizzle      |  |
| 5YT20 Heroic              |  | Ancillary                        |  | 40G19/466579-019 Fossilize   |  | ZNC18/466564-018 Cheerful    |  |
| 5YT21 Arpeggio            |  | 54" wide                         |  | 40G20/466579-020 Cattail     |  | ZNC19/466564-019 Watermelon  |  |
| 5YT22 Roots               |  | 28% wool                         |  | 40G21/466579-021 Shortcake   |  | ZNC20/466564-020 Toucan      |  |
| 5YT23 Sumac               |  | 26% viscose                      |  | 40G22/466579-022 Racecar     |  | ZNC21/466564-021 Rosin       |  |
| 5YT24 Purl                |  | 25% acrylic                      |  | 40G23/466579-023 Courtship   |  | ZNC22/466564-022 Jousting    |  |
| 5YT25 Homeward            |  | 16% polyester                    |  | 40G24/466579-024 Jam         |  | ZNC23/466564-023 Jojoba      |  |
|                           |  | 5% cotton                        |  | 40G25/466579-025 Sparrow     |  | ZNC24/466564-024 Dromedary   |  |
|                           |  | PFOA-Free stain resistant finish |  |                              |  | ZNC25/466564-025 Toasty      |  |
| <b>Cozy</b>               |  | 1GH01 Sand                       |  |                              |  | ZNC26/466564-026 Casaba      |  |
| Ancillary/Seating         |  | 1GH02 Fog                        |  |                              |  | ZNC27/466564-027 Greenhouse  |  |
| 54" wide                  |  | 1GH03 Flannel                    |  |                              |  | ZNC28/466564-028 Sibyl       |  |
| 100% wool                 |  | 1GH04 Trench                     |  |                              |  | ZNC29/466564-029 Spearmint   |  |
| 3CY01 Heathered Warm Grey |  | 1GH05 Vermillion                 |  |                              |  | ZNC30/466564-030 Pothos      |  |
| 3CY02 Heathered Rye Grass |  | 1GH06 Adriatic                   |  |                              |  | ZNC31/466564-031 Calathea    |  |
| 3CY03 Heathered Cool Grey |  | 1GH07 Umber                      |  |                              |  | ZNC32/466564-032 Landscape   |  |
| 3CY05 Heathered Black     |  | 1GH08 Charcoal                   |  |                              |  | ZNC33/466564-033 Espalier    |  |
| 3CY06 Heathered Persimmon |  |                                  |  |                              |  | ZNC34/466564-034 Gecko       |  |
| 3CY07 Heathered Loden     |  |                                  |  |                              |  | ZNC35/466564-035 Meditation  |  |
| 3CY09 Heathered Lagoon    |  |                                  |  |                              |  |                              |  |
| 3CY10 Heathered Twilight  |  |                                  |  |                              |  |                              |  |

Price category 5 continued on next page

- Maharam textiles are on assigned lead times **A**.
- Fabric numbers are listed as Herman Miller fabric number/Maharam fabric number.

# Textile Colors

continued

## Price Category 5

continued

| Summit                 |            |
|------------------------|------------|
| Ancillary/Seating      |            |
| 54" wide               |            |
| 100% silicone          |            |
| Polyester knit backing |            |
| 3SU02                  | Oyster     |
| 3SU03                  | Zinc       |
| 3SU04                  | Sparrow    |
| 3SU07                  | Black      |
| 3SU09                  | Beachglass |
| 3SU10                  | Midnight   |

| Vionette - Geiger Textile |                   |
|---------------------------|-------------------|
| Ancillary                 |                   |
| 55" wide                  |                   |
| 100% polyester            |                   |
| 1GJ01                     | White Sand Mix    |
| 1GJ02                     | Desert Mix        |
| 1GJ03                     | Light Gray Mix    |
| 1GJ04                     | Pewter Mix        |
| 1GJ05                     | Cobalt Mix        |
| 1GJ06                     | Prussian Blue Mix |
| 1GJ07                     | Chocolate Mix     |
| 1GJ08                     | Champagne         |
| 1GJ09                     | Morning Sky       |
| 1GJ10                     | Aquatic           |
| 1GJ11                     | Sapphire          |
| 1GJ12                     | Midnight Blue     |
| 1GJ13                     | Shadow            |
| 1GJ14                     | Java              |
| 1GJ15                     | Carbon            |
| 1GJ16                     | Black             |
| 1GJ17                     | Claret            |
| 1GJ18                     | Poppy             |

## Price Category 6

| Balance            |        |
|--------------------|--------|
| Seating            |        |
| For Embody® chairs |        |
| 100% polyester     |        |
| 3512               | Carbon |
| 3513               | Black  |

| Outdoor Weave             |          |
|---------------------------|----------|
| Ancillary                 |          |
| For Eames® Aluminum Group |          |
| Outdoor Chairs            |          |
| 50% elastomeric           |          |
| 50% polypropylene         |          |
| 7203                      | Lead     |
| 7205                      | Graphite |

## Price Category 7

| Customer's Own Leather         |  |
|--------------------------------|--|
| See Order Information in       |  |
| Appendices. Assigned lead-time |  |
| textile. <sup>A</sup>          |  |

| Bamboo           |        |
|------------------|--------|
| Ancillary        |        |
| 83% bamboo       |        |
| 17% polyurethane |        |
| 1BB01            | Ivory  |
| 1BB02            | Russet |
| 1BB03            | Black  |

| Beck – Maharam    |             |
|-------------------|-------------|
| Ancillary/Seating |             |
| 55" wide          |             |
| 78% wool          |             |
| 22% nylon         |             |
| ZB301/466571-001  | Overshadow  |
| ZB302/466571-002  | Molecule    |
| ZB303/466571-003  | Zeitgeist   |
| ZB304/466571-004  | Blacksmith  |
| ZB305/466571-005  | Cornerstone |
| ZB306/466571-006  | Chainmail   |
| ZB307/466571-007  | Buckram     |
| ZB308/466571-008  | Callisto    |
| ZB309/466571-009  | Interlude   |
| ZB310/466571-010  | Letterpress |
| ZB311/466571-011  | Memoir      |
| ZB312/466571-012  | Litmus      |
| ZB313/466571-013  | Stoic       |
| ZB314/466571-014  | Inkpad      |
| ZB315/466571-015  | Praxis      |
| ZB316/466571-016  | Astute      |
| ZB317/466571-017  | Percolate   |
| ZB318/466571-018  | Halocline   |
| ZB319/466571-019  | Semblance   |
| ZB320/466571-020  | Loch        |
| ZB321/466571-021  | Lido        |
| ZB322/466571-022  | Underwater  |
| ZB323/466571-023  | Tetrapod    |
| ZB324/466571-024  | Nymph       |
| ZB325/466571-025  | Appalachian |

| Beck continued   |                      |
|------------------|----------------------|
| ZB326/466571-026 | Menthol              |
| ZB327/466571-027 | Woodruff             |
| ZB328/466571-028 | Malachite            |
| ZB329/466571-029 | Botanist             |
| ZB330/466571-030 | Woodlet              |
| ZB331/466571-031 | Katydid              |
| ZB332/466571-032 | Exuberant            |
| ZB333/466571-033 | Retrospect           |
| ZB334/466571-034 | Lambic               |
| ZB335/466571-035 | Argil                |
| ZB336/466571-036 | Brushstroke          |
| ZB337/466571-037 | Candescent           |
| ZB338/466571-038 | Reedbuck             |
| ZB339/466571-039 | Clayware             |
| ZB340/466571-040 | Curio                |
| ZB341/466571-041 | Whimsy               |
| ZB342/466571-042 | Effervescent         |
| ZB343/466571-043 | Lingonberry          |
| ZB344/466571-044 | Resplendent          |
| ZB345/466571-045 | Hollyhock            |
| ZB346/466571-046 | Filigree             |
| ZB347/466571-047 | Plutonic             |
| ZB348/466571-048 | Foundry              |
| ZB349/466571-049 | Patisserie           |
| ZB390            | Gold 007/032/033 *   |
| ZB391            | Russet 036/040/039 * |
| ZB392            | Indigo 008/013/014 * |
| ZB393            | Forest 006/031/028 * |

\* Colors available only on Girard Color Wheel Ottoman.

Price category 7 continued on next page

- Maharam textiles are on assigned lead times <sup>A</sup>.
- Fabric numbers are listed as Herman Miller fabric number/Maharam fabric number.

# Textile Colors

continued

## Price Category 7

continued

Appendix: Textile Colors

| Bellano - Geiger Textile |             |
|--------------------------|-------------|
| Ancillary                |             |
| 55" wide                 |             |
| 75% wool                 |             |
| 10% linen                |             |
| 8% nylon                 |             |
| 7% alpaca                |             |
| 1AX01                    | Pearl       |
| 1AX02                    | Fog         |
| 1AX03                    | Fawn        |
| 1AX04                    | Pumice      |
| 1AX05                    | Pewter      |
| 1AX06                    | Atlantic    |
| 1AX07                    | Black Green |
| 1AX08                    | Adriatic    |
| 1AX09                    | Coffee      |
| 1AX10                    | Charcoal    |
| 1AX11                    | Umber       |
| 1AX12                    | Magenta     |
| 1AX13                    | Bittersweet |
| 1AX14                    | Sunflower   |

| Capri - Geiger Textile           |                |
|----------------------------------|----------------|
| Ancillary                        |                |
| 55" wide                         |                |
| 36% cotton                       |                |
| 32% acrylic                      |                |
| 24% rayon                        |                |
| 8% polyester                     |                |
| PFOA-Free stain resistant finish |                |
| Acrylic backing                  |                |
| 17201                            | Snow           |
| 17202                            | Stone          |
| 17203                            | Trench         |
| 17204                            | Graphite       |
| 17205                            | Anthracite     |
| 17206                            | Light Silver   |
| 17207                            | Russet         |
| 17208                            | Chestnut Brown |
| 17209                            | Sand           |
| 17210                            | Sterling       |
| 17211                            | Cobalt         |
| 17212                            | Ink            |

| Mantle - Maharam       |            |
|------------------------|------------|
| Ancillary/Seating      |            |
| 59% recycled polyester |            |
| 37% polyester          |            |
| 4% spandex             |            |
| 8PV01                  | Pavement   |
| 8PV02                  | Future     |
| 8PV03                  | Piper      |
| 8PV04                  | Manifesto  |
| 8PV05                  | Mapo       |
| 8PV06                  | Redwood    |
| 8PV07                  | Rocky      |
| 8PV08                  | Impala     |
| 8PV09                  | Warbler    |
| 8PV10                  | Guild      |
| 8PV11                  | Kinetic    |
| 8PV12                  | Behold     |
| 8PV13                  | Orb        |
| 8PV14                  | Sport      |
| 8PV15                  | Utopia     |
| 8PV16                  | True       |
| 8PV17                  | Galore     |
| 8PV18                  | Parsley    |
| 8PV19                  | Dare       |
| 8PV20                  | Branzino   |
| 8PV21                  | Network    |
| 8PV22                  | Standard   |
| 8PV23                  | Salamander |
| 8PV24                  | Oscillate  |

| Milaner - Geiger Textile |             |
|--------------------------|-------------|
| Ancillary                |             |
| 55" wide                 |             |
| 56% wool, 10% acrylic    |             |
| 10% alpaca, 10% cotton   |             |
| 8% nylon, 6% rayon       |             |
| 17101                    | Linen       |
| 17102                    | Flax        |
| 17103                    | Bark        |
| 17104                    | Deep Navy   |
| 17105                    | Charcoal    |
| 17106                    | Medium Grey |
| 17107                    | Ash         |
| 17108                    | Crimson     |

| Panno di Dolce - Geiger Textile |                    |
|---------------------------------|--------------------|
| Ancillary                       |                    |
| 55" wide                        |                    |
| 65% wool                        |                    |
| 20% nylon                       |                    |
| 15% alpaca                      |                    |
| 1AV01                           | Fog                |
| 1AV02                           | Dune               |
| 1AV03                           | Trench             |
| 1AV04                           | Flannel            |
| 1AV05                           | Charcoal           |
| 1AV06                           | Umber              |
| 1AV07                           | Deep Navy          |
| 1AV08                           | Graphite           |
| 1AV09                           | Orange             |
| 1AV10                           | Pink               |
| 1AV11                           | Deep Red           |
| 1AV12                           | Bright Green       |
| 1AV13                           | Cerulean Blue      |
| 1AV14                           | Deep Cerulean Blue |

| Pristina - Geiger Textile |            |
|---------------------------|------------|
| Ancillary                 |            |
| 55" wide                  |            |
| 37% wool                  |            |
| 25% viscose               |            |
| 17% acrylic               |            |
| 15% cotton                |            |
| 6% polyester              |            |
| PFOA-Free stain resistant |            |
| 1JC01                     | Dove       |
| 1JC02                     | Goldstone  |
| 1JC03                     | Daybreak   |
| 1JC04                     | Pumice     |
| 1JC05                     | Cappuccino |
| 1JC06                     | Gunmetal   |
| 1JC07                     | Caspian    |
| 1JC08                     | Café Noir  |

| Resca - Geiger Textile |          |
|------------------------|----------|
| Ancillary              |          |
| 56" wide               |          |
| 75% wool               |          |
| 10% linen              |          |
| 8% nylon               |          |
| 7% alpaca              |          |
| 1AW01                  | Fog      |
| 1AW02                  | Dune     |
| 1AW03                  | Trench   |
| 1AW04                  | Flannel  |
| 1AW05                  | Umber    |
| 1AW06                  | Bordeaux |

| Rowan - Maharam   |              |
|-------------------|--------------|
| Ancillary/Seating |              |
| 77% wool          |              |
| 12% nylon         |              |
| 6% acrylic        |              |
| 5% linen          |              |
| 5K301             | Kingdom      |
| 5K302             | Northern     |
| 5K303             | Rabbit       |
| 5K304             | Elephant     |
| 5K305             | Furrow       |
| 5K306             | Heirloom     |
| 5K307             | Appear       |
| 5K308             | Repose       |
| 5K309             | Blackcurrant |
| 5K310             | Courage      |
| 5K311             | Bordeaux     |
| 5K312             | Cherish      |
| 5K313             | Brickfield   |
| 5K314             | Hibiscus     |
| 5K315             | Carnelian    |
| 5K316             | Cinnabar     |
| 5K317             | Toasted      |
| 5K318             | Revea        |
| 5K319             | Cortado      |
| 5K320             | Medallion    |
| 5K321             | Polenta      |

Price category 7 continued on next page

- Maharam textiles are on assigned lead times [A](#).
- Fabric numbers are listed as Herman Miller fabric number/Maharam fabric number.

# Textile Colors

continued

## Price Category 7

continued

| Rowan continued |            |
|-----------------|------------|
| 5K322           | Prized     |
| 5K323           | Travertine |
| 5K324           | Companion  |
| 5K325           | Library    |
| 5K326           | Fable      |
| 5K327           | Pixie      |
| 5K328           | Arboretum  |
| 5K329           | Ease       |
| 5K330           | Sapling    |
| 5K331           | Cottonwood |
| 5K332           | Scout      |
| 5K333           | Valleyside |
| 5K334           | Ornament   |
| 5K335           | Zucchini   |
| 5K336           | Ethereal   |
| 5K337           | Springtide |
| 5K338           | Traverse   |
| 5K339           | Untold     |
| 5K340           | Flowing    |
| 5K341           | Laguna     |
| 5K342           | Cerulean   |
| 5K343           | Soundscape |
| 5K344           | Message    |
| 5K345           | Freefall   |
| 5K346           | Musical    |
| 5K347           | Puzzle     |
| 5K348           | Operatic   |
| 5K349           | Daydream   |
| 5K350           | Shale      |
| 5K351           | Forward    |
| 5K352           | Anthracite |

| Vesture - Geiger Textile         |             |
|----------------------------------|-------------|
| Ancillary                        |             |
| 55" wide                         |             |
| 40% wool, 25% polyester          |             |
| 20% silk, 15% nylon              |             |
| PFOA-Free stain resistant finish |             |
| 21701                            | Ashen       |
| 21702                            | Dark Blush  |
| 21703                            | Dusk        |
| 21704                            | Medium Gray |
| 21705                            | Twilight    |

| Wool Epinglé - Geiger Textile |                      |
|-------------------------------|----------------------|
| Ancillary                     |                      |
| 54" wide                      |                      |
| 100% wool                     |                      |
| 16201                         | Swiss Red            |
| 16202                         | Orange               |
| 16203                         | Light Chestnut Brown |
| 16204                         | Light Burnt Umber    |
| 16205                         | Pale Native Umber    |
| 16207                         | Grey                 |
| 16208                         | Natier Blue          |
| 16209                         | Deep Cerulean Blue   |
| 16210                         | Anthracite           |
| 16211                         | Natural Native Umber |
| 16212                         | Chestnut Brown       |

| Wool Tweed - Geiger Textile |           |
|-----------------------------|-----------|
| Ancillary                   |           |
| 54" wide                    |           |
| 80% wool, 20% nylon         |           |
| 16601                       | Trench    |
| 16602                       | Pewter    |
| 16603                       | Ruby      |
| 16604                       | Blue Gray |
| 16605                       | Navy      |
| 16606                       | Umber     |
| 16607                       | Charcoal  |

## Price Category 8

| Breeze - Maharam           |           |
|----------------------------|-----------|
| Workspaces                 |           |
| 120" wide                  |           |
| 65% FR polyester           |           |
| 35% post-consumer recycled |           |
| FR polyester               |           |
| 1QG06/283817-006           | Meteorite |
| 1QG09/283817-009           | Serum     |

| Luce - Maharam                  |            |
|---------------------------------|------------|
| Ancillary/Seating               |            |
| 59" wide                        |            |
| 75% post-consumer recycled wool |            |
| 20% polyester                   |            |
| 5% nylon                        |            |
| ZLU01/466566-001                | Brioche    |
| ZLU02/466566-002                | Blanched   |
| ZLU03/466566-003                | Relic      |
| ZLU04/466566-004                | Sinter     |
| ZLU05/466566-005                | Scoria     |
| ZLU06/466566-006                | Austere    |
| ZLU07/466566-007                | Pigment    |
| ZLU08/466566-008                | Alkali     |
| ZLU09/466566-009                | Tidal      |
| ZLU10/466566-010                | Imbue      |
| ZLU11/466566-011                | Reservoir  |
| ZLU12/466566-012                | Brine      |
| ZLU13/466566-013                | Undertone  |
| ZLU14/466566-014                | Prelude    |
| ZLU15/466566-015                | Submerge   |
| ZLU16/466566-016                | Cypress    |
| ZLU17/466566-017                | Awash      |
| ZLU18/466566-018                | Adriatic   |
| ZLU19/466566-019                | Province   |
| ZLU20/466566-020                | Virescent  |
| ZLU21/466566-021                | Nettle     |
| ZLU22/466566-022                | Agrarian   |
| ZLU23/466566-023                | Serpentine |
| ZLU24/466566-024                | Laurel     |
| ZLU25/466566-025                | Clarion    |
| ZLU26/466566-026                | Gooseberry |
| ZLU27/466566-027                | Swelter    |
| ZLU28/466566-028                | Etruscan   |
| ZLU29/466566-029                | Coulis     |
| ZLU30/466566-030                | Rubescant  |

| Luce continued   |          |
|------------------|----------|
| ZLU31/466566-031 | Akoya    |
| ZLU32/466566-032 | Radiant  |
| ZLU33/466566-033 | Regent   |
| ZLU34/466566-034 | Spectral |
| ZLU35/466566-035 | Thistle  |

| Tempo - Maharam   |            |
|-------------------|------------|
| Ancillary         |            |
| 55" wide          |            |
| 100% polyester    |            |
| Polyester backing |            |
| 26S01/466589-001  | Chert      |
| 26S02/466589-002  | Grandstand |
| 26S03/466589-003  | Restful    |
| 26S04/466589-004  | Battleship |
| 26S05/466589-005  | Lavender   |
| 26S06/466589-006  | Dockside   |
| 26S07/466589-007  | Swimming   |
| 26S08/466589-008  | Ambience   |
| 26S09/466589-009  | Adornment  |
| 26S10/466589-010  | Remedy     |
| 26S11/466589-011  | Fang       |
| 26S12/466589-012  | Inshore    |
| 26S13/466589-013  | Camouflage |
| 26S14/466589-014  | Mesclun    |
| 26S15/466589-015  | Farmland   |
| 26S16/466589-016  | Tadpole    |
| 26S17/466589-017  | Purr       |
| 26S18/466589-018  | Snowman    |
| 26S19/466589-019  | Beehive    |
| 26S20/466589-020  | Gazelle    |
| 26S21/466589-021  | Shiitake   |
| 26S22/466589-022  | Flaxseed   |
| 26S23/466589-023  | Crawdad    |
| 26S24/466589-024  | Flowery    |
| 26S25/466589-025  | Burgundy   |
| 26S26/466589-026  | Rangoli    |
| 26S27/466589-027  | Petunia    |
| 26S28/466589-028  | Campsite   |

Price category 8 continued on next page

- Maharam textiles are on assigned lead times <sup>A</sup>.
- Fabric numbers are listed as Herman Miller fabric number/Maharam fabric number.

# Textile Colors

continued

## Price Category 8

continued

## Price Category 9

Appendix: Textile Colors

| Whim         |              |
|--------------|--------------|
| Ancillary    |              |
| 54" wide     |              |
| 34% viscose  |              |
| 33% acrylic  |              |
| 17% wool     |              |
| 8% polyester |              |
| 9DA01        | Warm White   |
| 9DA02        | Rye          |
| 9DA03        | Mustard Seed |
| 9DA04        | Terra Cotta  |
| 9DA05        | Fir          |
| 9DA06        | Navy         |
| 9DA07        | Pewter       |

| Alpaca Mohair - Geiger Textile |          |
|--------------------------------|----------|
| Ancillary                      |          |
| 54" wide                       |          |
| 63% alpaca                     |          |
| 21% cotton, 16% polyester      |          |
| 18510                          | Dune     |
| 18511                          | Trench   |
| 18512                          | Vicuna   |
| 18570                          | Sepia    |
| 18571                          | Umber    |
| 18580                          | Fog      |
| 18581                          | Flannel  |
| 18582                          | Charcoal |

| Campana – Maharam |              |
|-------------------|--------------|
| Ancillary/Seating |              |
| 59" wide          |              |
| 85% wool          |              |
| 15% nylon         |              |
| ZC001/466571-001  | Viverine     |
| ZC002/466571-002  | Lithograph   |
| ZC003/466571-003  | Moonscape    |
| ZC004/466571-004  | Brevity      |
| ZC005/466571-005  | Linear       |
| ZC006/466571-006  | Hinterland   |
| ZC007/466571-007  | Mural        |
| ZC008/466571-008  | Sloe         |
| ZC009/466571-009  | Interstellar |
| ZC010/466571-010  | Mythology    |
| ZC011/466571-011  | Scintillate  |
| ZC012/466571-012  | Succession   |
| ZC013/466571-013  | Visceral     |
| ZC014/466571-014  | Hemisphere   |
| ZC015/466571-015  | Troposphere  |
| ZC016/466571-016  | Skye         |
| ZC017/466571-017  | Seaward      |
| ZC018/466571-018  | Nemorous     |
| ZC019/466571-019  | Allegory     |
| ZC020/466571-020  | Olivine      |
| ZC021/466571-021  | Reptilian    |
| ZC022/466571-022  | Basil        |
| ZC023/466571-023  | Fanleaf      |
| ZC024/466571-024  | Beachgrass   |
| ZC025/466571-025  | Hayfield     |

| Campana continued |             |
|-------------------|-------------|
| ZC026/466571-026  | Freesia     |
| ZC027/466571-027  | Rhodium     |
| ZC028/466571-028  | Undercoat   |
| ZC029/466571-029  | Airbrush    |
| ZC030/466571-030  | Shellfish   |
| ZC031/466571-031  | Mojave      |
| ZC032/466571-032  | Renaissance |
| ZC033/466571-033  | Decoupage   |
| ZC034/466571-034  | Outback     |
| ZC035/466571-035  | Millipede   |

| Gemma – Maharam   |            |
|-------------------|------------|
| Ancillary/Seating |            |
| 55" wide          |            |
| 85% wool          |            |
| 15% nylon         |            |
| ZGE01/466568-001  | Crinoline  |
| ZGE02/466568-002  | Angelic    |
| ZGE03/466568-003  | Savory     |
| ZGE04/466568-004  | Honeycomb  |
| ZGE05/466568-005  | Gilded     |
| ZGE06/466568-006  | Paddleboat |
| ZGE07/466568-007  | Stagecoach |
| ZGE08/466568-008  | Waterbuck  |
| ZGE09/466568-009  | Earnest    |
| ZGE10/466568-010  | Auric      |
| ZGE11/466568-011  | Carmine    |
| ZGE12/466568-012  | Serape     |
| ZGE13/466568-013  | Ferric     |
| ZGE14/466568-014  | Canyon     |
| ZGE15/466568-015  | Alembic    |
| ZGE16/466568-016  | Patio      |
| ZGE17/466568-017  | Sorrel     |
| ZGE18/466568-018  | Root       |

| Gemma continued  |             |
|------------------|-------------|
| ZGE19/466568-019 | Mansion     |
| ZGE20/466568-020 | Buff        |
| ZGE21/466568-021 | Starch      |
| ZGE22/466568-022 | Dawn        |
| ZGE23/466568-023 | Countryside |
| ZGE24/466568-024 | Dewy        |
| ZGE25/466568-025 | Reliquary   |
| ZGE26/466568-026 | Deluge      |
| ZGE27/466568-027 | Overlay     |
| ZGE28/466568-028 | Electron    |
| ZGE29/466568-029 | Sheath      |
| ZGE30/466568-030 | Quietude    |
| ZGE31/466568-031 | Jargon      |
| ZGE32/466568-032 | Powder      |
| ZGE33/466568-033 | Tide        |
| ZGE34/466568-034 | Outwash     |
| ZGE35/466568-035 | Enamored    |
| ZGE36/466568-036 | Smitten     |
| ZGE37/466568-037 | Revere      |
| ZGE38/466568-038 | Mangosteen  |
| ZGE39/466568-039 | Allium      |
| ZGE40/466568-040 | Immense     |
| ZGE41/466568-041 | Chamber     |
| ZGE42/466568-042 | Cosmos      |
| ZGE43/466568-043 | Inkling     |
| ZGE44/466568-044 | Rainwater   |
| ZGE45/466568-045 | Shade       |
| ZGE46/466568-046 | Pendant     |
| ZGE47/466568-047 | Axial       |
| ZGE48/466568-048 | Fervent     |
| ZGE49/466568-049 | Legacy      |
| ZGE50/466568-050 | Caliber     |
| ZGE51/466568-051 | Temple      |
| ZGE52/466568-052 | Evenfall    |

Price category 9 continued on next page

- Maharam textiles are on assigned lead times **A**.
- Fabric numbers are listed as Herman Miller fabric number/Maharam fabric number.



# Textile Colors

continued

## Price Category 9

continued

| Jasper - Maharam              |
|-------------------------------|
| Ancillary/Seating             |
| 53" wide                      |
| 55% wool                      |
| 27% solution-dyed nylon       |
| 18% cotton                    |
| ZJA01/466563-001 Thrill       |
| ZJA02/466563-002 Anise        |
| ZJA03/466563-003 Grapefruit   |
| ZJA04/466563-004 Lifeguard    |
| ZJA05/466563-005 Heartfelt    |
| ZJA06/466563-006 Corsage      |
| ZJA07/466563-007 Earthenware  |
| ZJA08/466563-008 Bear         |
| ZJA09/466563-009 Firelight    |
| ZJA10/466563-010 Dreamcatcher |
| ZJA11/466563-011 Bobcat       |
| ZJA12/466563-012 Glacial      |
| ZJA13/466563-013 Vaporize     |
| ZJA14/466563-014 Trapdoor     |
| ZJA15/466563-015 Halcyon      |
| ZJA16/466563-016 Observatory  |
| ZJA17/466563-017 Steamboat    |
| ZJA18/466563-018 Aquathlon    |
| ZJA19/466563-019 Cloudless    |
| ZJA20/466563-020 Briny        |
| ZJA21/466563-021 Magical      |
| ZJA22/466563-022 Picnic       |
| ZJA23/466563-023 Herbage      |
| ZJA24/466563-024 Pasture      |
| ZJA25/466563-025 Courtyard    |
| ZJA26/466563-026 Leapfrog     |

| Leather                     |
|-----------------------------|
| Ancillary/Seating           |
| approx. 50 sq. ft. per hide |
| 100% leather                |
| 2101 Ivory                  |
| 2109 Black *                |
| 2110 Smoke                  |
| 2111 Graphite               |
| 2112 Khaki                  |
| 2113 Rattan                 |
| 2114 Truffle                |
| 2115 Alpine                 |
| 2116 Haze                   |
| 2117 Sable Grey             |
| 2118 Dark Mineral **        |
| 2119 Dark Carbon ***        |
| 2120 Cranberry              |
| 2121 Deep Sea               |

\* Armpad color available on Aeron® Chair, Graphite.  
 \*\* Armpad color available on Aeron Chair, Mineral.  
 \*\*\* Armpad color available on Aeron Chair, Carbon.

## Price Category 10

| Bristol Leather - Geiger Textile |
|----------------------------------|
| Ancillary                        |
| approx. 55 sq. ft. per hide      |
| 100% leather                     |
| 5-507 Black                      |
| 5-511 Putty                      |
| 5-519 Hunter                     |
| 5-520 White                      |
| 5-521 Ivory                      |
| 5-522 Parchment                  |
| 5-537 Caribbean                  |
| 5-546 Pumice                     |
| 5-547 Smoke                      |
| 5-548 Charcoal                   |
| 5-549 Dark Shale                 |
| 5-556 Downtown Grey              |
| 5-557 City Night                 |
| 5-559 Ash Grey                   |
| 5-563 Champagne                  |
| 5-564 Chestnut Brown             |
| 5-565 Dark Sienna                |
| 5-566 Earthen                    |
| 5-567 Desert                     |
| 5-568 British Green              |
| 5-579 Paris Blue                 |
| 5-583 Atlantic                   |
| 5-592 Camel                      |
| 5-594 Taupe                      |
| 5-597 Pure *                     |
| 5-598 Cream                      |
| 5-600 Midnight Blue              |
| 5-603 Sangria                    |
| 5-604 Swiss Red                  |
| 5-605 Nordic Yellow              |
| 5-606 Sky Grey                   |
| 5-608 Natural                    |

\* Color not available on Saiba Chair.

| Firma – Maharam             |
|-----------------------------|
| Ancillary/Seating           |
| 55" wide                    |
| 78% wool                    |
| 22% nylon                   |
| 3KH01/466582-001 Wrath      |
| 3KH02/466582-002 Pantomime  |
| 3KH03/466582-003 Shaded     |
| 3KH04/466582-004 Prologue   |
| 3KH05/466582-005 Framework  |
| 3KH06/466582-006 Railroad   |
| 3KH07/466582-007 Grommet    |
| 3KH08/466582-008 Lunisolar  |
| 3KH09/466582-009 Snowpack   |
| 3KH10/466582-010 Coldsnap   |
| 3KH11/466582-011 Sealift    |
| 3KH12/466582-012 Brood      |
| 3KH13/466582-013 Intertidal |
| 3KH14/466582-014 Confide    |
| 3KH15/466582-015 Secluded   |
| 3KH16/466582-016 Leisure    |
| 3KH17/466582-017 Portfolio  |
| 3KH18/466582-018 Strato     |
| 3KH19/466582-019 Fogbow     |
| 3KH20/466582-020 Snowcone   |
| 3KH21/466582-021 Kazoo      |
| 3KH22/466582-022 Esteem     |
| 3KH23/466582-023 Mackerel   |
| 3KH24/466582-024 Brooch     |
| 3KH25/466582-025 Caesious   |
| 3KH26/466582-026 Islet      |
| 3KH27/466582-027 Biosphere  |
| 3KH28/466582-028 Hilltop    |
| 3KH29/466582-029 Arboreal   |
| 3KH30/466582-030 Lineage    |
| 3KH31/466582-031 Comfrey    |
| 3KH32/466582-032 Circe      |
| 3KH33/466582-033 Ecosystem  |
| 3KH34/466582-034 Knack      |
| 3KH35/466582-035 Watt       |
| 3KH36/466582-036 Epiphany   |
| 3KH37/466582-037 Gamma      |
| 3KH38/466582-038 Taxicab    |
| 3KH39/466582-039 Varietal   |
| 3KH40/466582-040 Tale       |

Price category 10 continued on next page

- Maharam textiles are on assigned lead times A.
- Fabric numbers are listed as Herman Miller fabric number/Maharam fabric number.

# Textile Colors

continued

## Price Category 10

continued

| Firma continued  |            |
|------------------|------------|
| 3KH41/466582-041 | Elemental  |
| 3KH42/466582-042 | Cuff       |
| 3KH43/466582-043 | Emu        |
| 3KH44/466582-044 | Tempeh     |
| 3KH45/466582-045 | Tephra     |
| 3KH46/466582-046 | Shellac    |
| 3KH47/466582-047 | Emporium   |
| 3KH48/466582-048 | Keratin    |
| 3KH49/466582-049 | Camwood    |
| 3KH50/466582-050 | Gloam      |
| 3KH51/466582-051 | Novela     |
| 3KH52/466582-052 | Fruitpunch |
| 3KH53/466582-053 | Decant     |
| 3KH54/466582-054 | Milkshake  |
| 3KH55/466582-055 | Metaphysic |
| 3KH56/466582-056 | Carafe     |
| 3KH57/466582-057 | Voyager    |
| 3KH58/466582-058 | Tenebrous  |
| 3KH59/466582-059 | Subtext    |
| 3KH60/466582-060 | Silent     |

| Gemma Multi – Maharam |             |
|-----------------------|-------------|
| Ancillary/Seating     |             |
| 55" wide              |             |
| 85% wool              |             |
| 15% nylon             |             |
| ZGF01/466569-001      | Andromeda   |
| ZGF02/466569-002      | Dappled     |
| ZGF03/466569-003      | Lyra        |
| ZGF04/466569-004      | Flaunt      |
| ZGF05/466569-005      | Celluloid   |
| ZGF06/466569-006      | Hydrozoa    |
| ZGF07/466569-007      | Firefly     |
| ZGF08/466569-008      | Pisces      |
| ZGF09/466569-009      | Strath      |
| ZGF10/466569-010      | Erosion     |
| ZGF11/466569-011      | Cabaret     |
| ZGF12/466569-012      | Candytuft   |
| ZGF13/466569-013      | Juice       |
| ZGF14/466569-014      | Fairground  |
| ZGF15/466569-015      | Copperplate |
| ZGF16/466569-016      | Sunbird     |
| ZGF17/466569-017      | Cinematic   |
| ZGF18/466569-018      | Clairvoyant |

| Gemma Multi continued |              |
|-----------------------|--------------|
| ZGF19/466569-019      | Crocus       |
| ZGF20/466569-020      | Memoir       |
| ZGF21/466569-021      | Roulette     |
| ZGF22/466569-022      | Voltaic      |
| ZGF23/466569-023      | Compote      |
| ZGF24/466569-024      | Lambent      |
| ZGF25/466569-025      | Twister      |
| ZGF26/466569-026      | Chronicle    |
| ZGF27/466569-027      | Sidereal     |
| ZGF28/466569-028      | Tanzanite    |
| ZGF29/466569-029      | Crystalize   |
| ZGF30/466569-030      | Chromium     |
| ZGF31/466569-031      | Pallium      |
| ZGF32/466569-032      | Spectre      |
| ZGF33/466569-033      | Courgette    |
| ZGF34/466569-034      | Viper        |
| ZGF35/466569-035      | Sunlit       |
| ZGF36/466569-036      | Heavenly     |
| ZGF37/466569-037      | Vernal       |
| ZGF38/466569-038      | Cress        |
| ZGF39/466569-039      | Limn         |
| ZGF40/466569-040      | Horseradish  |
| ZGF41/466569-041      | Shandy       |
| ZGF42/466569-042      | Granary      |
| ZGF43/466569-043      | Percolate    |
| ZGF44/466569-044      | Motor        |
| ZGF45/466569-045      | Unicorn      |
| ZGF46/466569-046      | Lobster      |
| ZGF47/466569-047      | Rhododendron |
| ZGF48/466569-048      | Taffy        |
| ZGF49/466569-049      | Rishi        |
| ZGF50/466569-050      | Backcountry  |
| ZGF51/466569-051      | Buckthorn    |
| ZGF52/466569-052      | Coniferous   |
| ZGF53/466569-053      | Delphic      |
| ZGF54/466569-054      | Hieroglyph   |
| ZGF55/466569-055      | Eiderdown    |
| ZGF56/466569-056      | Sandbar      |
| ZGF57/466569-057      | Tanager      |

| Gemma Multi Reverse – Maharam |             |
|-------------------------------|-------------|
| Ancillary/Seating             |             |
| 55" wide                      |             |
| 85% wool                      |             |
| 15% nylon                     |             |
| ZGF58/466569-101              | Andromeda   |
|                               | Reverse     |
| ZGF59/466569-102              | Dappled     |
|                               | Reverse     |
| ZGF60/466569-103              | Lyra        |
|                               | Reverse     |
| ZGF61/466569-104              | Flaunt      |
|                               | Reverse     |
| ZGF62/466569-105              | Celluloid   |
|                               | Reverse     |
| ZGF63/466569-106              | Hydrozoa    |
|                               | Reverse     |
| ZGF64/466569-107              | Firefly     |
|                               | Reverse     |
| ZGF65/466569-108              | Pisces      |
|                               | Reverse     |
| ZGF66/466569-109              | Strath      |
|                               | Reverse     |
| ZGF67/466569-110              | Erosion     |
|                               | Reverse     |
| ZGF68/466569-111              | Cabaret     |
|                               | Reverse     |
| ZGF69/466569-112              | Candytuft   |
|                               | Reverse     |
| ZGF70/466569-113              | Juice       |
|                               | Reverse     |
| ZGF71/466569-114              | Fairground  |
|                               | Reverse     |
| ZGF72/466569-115              | Copperplate |
|                               | Reverse     |
| ZGF73/466569-116              | Sunbird     |
|                               | Reverse     |
| ZGF74/466569-117              | Cinematic   |
|                               | Reverse     |
| ZGF75/466569-118              | Clairvoyant |
|                               | Reverse     |
| ZGF76/466569-119              | Crocus      |
|                               | Reverse     |
| ZGF77/466569-120              | Memoir      |
|                               | Reverse     |

| Gemma Multi Reverse continued |             |
|-------------------------------|-------------|
| ZGF78/466569-121              | Roulette    |
|                               | Reverse     |
| ZGF79/466569-122              | Voltaic     |
|                               | Reverse     |
| ZGF80/466569-123              | Compote     |
|                               | Reverse     |
| ZGF81/466569-124              | Lambent     |
|                               | Reverse     |
| ZGF82/466569-125              | Twister     |
|                               | Reverse     |
| ZGF83/466569-126              | Chronicle   |
|                               | Reverse     |
| ZGF84/466569-127              | Sidereal    |
|                               | Reverse     |
| ZGF85/466569-128              | Tanzanite   |
|                               | Reverse     |
| ZGF86/466569-129              | Crystalize  |
|                               | Reverse     |
| ZGF87/466569-130              | Chromium    |
|                               | Reverse     |
| ZGF88/466569-131              | Pallium     |
|                               | Reverse     |
| ZGF89/466569-132              | Spectre     |
|                               | Reverse     |
| ZGF90/466569-133              | Courgette   |
|                               | Reverse     |
| ZGF91/466569-134              | Viper       |
|                               | Reverse     |
| ZGF92/466569-135              | Sunlit      |
|                               | Reverse     |
| ZGF93/466569-136              | Heavenly    |
|                               | Reverse     |
| ZGF94/466569-137              | Vernal      |
|                               | Reverse     |
| ZGF95/466569-138              | Cress       |
|                               | Reverse     |
| ZGF96/466569-139              | Limn        |
|                               | Reverse     |
| ZGF97/466569-140              | Horseradish |
|                               | Reverse     |
| ZGF98/466569-141              | Shandy      |
|                               | Reverse     |
| ZGF99/466569-142              | Granary     |
|                               | Reverse     |

- Maharam textiles are on assigned lead times [A](#).
- Fabric numbers are listed as Herman Miller fabric number/Maharam fabric number.

Price category 10 continued on next page

# Textile Colors

continued

## Price Category 10

continued

### Gemma Multi Reverse *continued*

|                  |              |
|------------------|--------------|
| ZGFA0/466569-143 | Percolate    |
|                  | Reverse      |
| ZGFA1/466569-144 | Motor        |
|                  | Reverse      |
| ZGFA2/466569-145 | Unicorn      |
|                  | Reverse      |
| ZGFA3/466569-146 | Lobster      |
|                  | Reverse      |
| ZGFA4/466569-147 | Rhododendron |
|                  | Reverse      |
| ZGFA5/466569-148 | Taffy        |
|                  | Reverse      |
| ZGFA6/466569-149 | Rishi        |
|                  | Reverse      |
| ZGFA7/466569-150 | Backcountry  |
|                  | Reverse      |
| ZGFA8/466569-151 | Buckthorn    |
|                  | Reverse      |
| ZGFA9/466569-152 | Coniferous   |
|                  | Reverse      |
| ZGFB0/466569-153 | Delphic      |
|                  | Reverse      |
| ZGFB1/466569-154 | Hieroglyph   |
|                  | Reverse      |
| ZGFB2/466569-155 | Eiderdown    |
|                  | Reverse      |
| ZGFB3/466569-157 | Tanager      |
|                  | Reverse      |

### Petra - Maharam

|                   |             |
|-------------------|-------------|
| Ancillary/Seating |             |
| 55" wide          |             |
| 70% wool          |             |
| 19% linen         |             |
| 11% nylon         |             |
| ZP401/466580-001  | Hieroglyph  |
| ZP402/466580-002  | Interior    |
| ZP403/466580-003  | Samovar     |
| ZP404/466580-004  | Calcite     |
| ZP405/466580-005  | Silversmith |
| ZP406/466580-006  | Rivet       |
| ZP407/466580-007  | Carpolite   |
| ZP408/466580-008  | Bonbon      |

### Petra *continued*

|                  |            |
|------------------|------------|
| ZP409/466580-009 | Dreamy     |
| ZP410/466580-010 | Bejewel    |
| ZP411/466580-011 | Sashimi    |
| ZP412/466580-012 | Spirula    |
| ZP413/466580-013 | Chalet     |
| ZP414/466580-014 | Reindeer   |
| ZP415/466580-015 | Nostalgia  |
| ZP416/466580-016 | Trove      |
| ZP417/466580-017 | Narcissus  |
| ZP418/466580-018 | Yurt       |
| ZP419/466580-019 | Congee     |
| ZP420/466580-020 | Genepy     |
| ZP421/466580-021 | Herbaceous |
| ZP422/466580-022 | Paddock    |
| ZP423/466580-023 | Precious   |
| ZP424/466580-024 | Biome      |
| ZP425/466580-025 | Tinted     |
| ZP426/466580-026 | Pelagic    |
| ZP427/466580-027 | Bluebill   |
| ZP428/466580-028 | Chicory    |
| ZP429/466580-029 | Eaglet     |
| ZP430/466580-030 | Permafrost |
| ZP431/466580-031 | Atlantic   |
| ZP432/466580-032 | Airstream  |
| ZP433/466580-033 | Debonair   |

### Superweave - Maharam

|                  |                 |
|------------------|-----------------|
| Ancillary        |                 |
| 54" wide         |                 |
| 75% polyester    |                 |
| 25% cotton       |                 |
| Z2203/466241-005 | Sienna          |
| Z2204/466241-002 | Ochre           |
| Z2207/466241-004 | Marine          |
| Z2208/466241-003 | Olive           |
| Z2220/466241-001 | Orange and Pink |

## Price Category 11

### Felix - Maharam

|                   |          |
|-------------------|----------|
| Ancillary/Seating |          |
| 85% wool          |          |
| 15% nylon         |          |
| 3BS01             | Angular  |
| 3BS02             | Shark    |
| 3BS03             | Easy     |
| 3BS04             | Cue      |
| 3BS05             | Rye      |
| 3BS06             | Champion |
| 3BS07             | Between  |
| 3BS08             | Propose  |
| 3BS09             | Rising   |
| 3BS10             | Tile     |
| 3BS11             | Place    |
| 3BS12             | Kernel   |
| 3BS13             | Pinnacle |
| 3BS14             | Darling  |
| 3BS15             | Seasonal |
| 3BS16             | Shipmate |
| 3BS17             | Jump     |
| 3BS18             | Geyser   |
| 3BS19             | Team     |

### Prone Leather - Maharam

|                             |           |
|-----------------------------|-----------|
| Ancillary                   |           |
| approx. 50 sq. ft. per hide |           |
| 100% leather                |           |
| protective top coat         |           |
| 1NX01/700020-001            | Lotus     |
| 1NX02/700020-002            | Timbre    |
| 1NX03/700020-003            | Essence   |
| 1NX04/700020-004            | Script    |
| 1NX05/700020-005            | Gambit    |
| 1NX06/700020-006            | Obsidian  |
| 1NX07/700020-007            | Sail      |
| 1NX09/700020-009            | Vine      |
| 1NX10/700020-010            | Yarrow    |
| 1NX13/700020-013            | Balsa     |
| 1NX14/700020-014            | Shore     |
| 1NX15/700020-015            | Bricolage |
| 1NX17/700020-017            | Ledge     |
| 1NX19/700020-019            | Mantra    |
| 1NX20/700020-020            | Java      |
| 1NX21/700020-021            | Lute      |
| 1NX22/700020-022            | Glow      |
| 1NX23/700020-023            | Hickory   |

### Tenera Leather - Geiger Textile

|                             |                |
|-----------------------------|----------------|
| Ancillary                   |                |
| approx. 55 sq. ft. per hide |                |
| 100% leather                |                |
| 17501                       | Cement         |
| 17502                       | Marzipan       |
| 17504                       | Raw Sienna     |
| 17505                       | Maple          |
| 17508                       | Cranberry      |
| 17510                       | Dark Chocolate |
| 17511                       | Black          |
| 17512                       | Carbon         |
| 17513                       | Sapphire       |

- Maharam textiles are on assigned lead times [A](#).
- Fabric numbers are listed as Herman Miller fabric number/Maharam fabric number.

# Textile Colors

continued

Appendix: Textile Colors

## Price Category 12-13

No fabrics available at this time.

## Price Category 14

### Lanalux - Maharam

Ancillary  
 54" wide  
 100% wool  
 Z1375/466240-005 Black/White  
 Z1378/466240-006 Olive/Black  
 Z1380/466240-001 Natural  
 Z1383/466240-002 Umber  
 Z1384/466240-007 Natural/Black  
 Z1386/466240-003 Orange  
 Z1387/466240-004 Crimson

## Price Category A

No fabrics available at this time.

## Price Category B

### Medium – Maharam

Ancillary/Seating/Workspaces  
 54" wide  
 100% polyester  
 VM01/463490-001 Raven  
 VM02/463490-002 Smoke  
 VM03/463490-003 Alloy  
 VM04/463490-004 Flax  
 VM07/463490-007 Espresso  
 VM14/463490-014 Laser  
 VM16/463490-016 Port  
 VM22/463490-022 Marina  
 VM29/463490-029 Pistachio  
 VM32/463490-032 Prospect  
 VM36/463490-036 Delight  
 VM39/463490-039 Nautical  
 VM40/463490-040 Pool  
 VM44/463490-044 Washed  
 VM45/463490-045 Sculpture  
 VM46/463490-046 Thatched  
 VM47/463490-047 Hike  
 VM48/463490-048 Tangle  
 VM49/463490-049 Pacific  
 VM50/463490-050 Cosmic  
 VM51/463490-051 Cascade  
 VM52/463490-052 Blackberry  
 VM53/463490-053 Nasturtium

### Messenger – Maharam

Ancillary/Seating/Workspaces  
 54" wide  
 78% post-industrial recycled polyester  
 15% polyester, 7% nylon  
 TI07/458640-007 Shadow  
 TI08/458640-008 Bayou \*  
 TI24/458640-024 Poppy  
 TI25/458640-025 Mao  
 TI29/458640-029 Onyx \*  
 TI31/458640-031 Cloud \*  
 TI38/458640-038 Depth \*  
 TI40/458640-040 Nile \*  
 TI41/458640-041 Azure \*

Price category B continued on next page

- Maharam textiles are on assigned lead times [A](#).
- Fabric numbers are listed as Herman Miller fabric number/Maharam fabric number.

# Textile Colors

continued

## Price Category B

continued

| <b>Messenger continued</b> |             |
|----------------------------|-------------|
| TI45/458640-045            | Cactus *    |
| TI46/458640-046            | Ice * **    |
| TI48/458640-048            | Neon        |
| TI50/458640-050            | Hydrangea   |
| TI53/458640-053            | Tangelo     |
| TI54/458640-054            | Lumine *    |
| TI58/458640-058            | Snow ** *** |
| TI60/458640-060            | Peridot     |
| TI61/458640-061            | Capri *     |
| TI62/458640-062            | Ultramarine |
| TI63/458640-063            | Squall      |
| TI66/458640-066            | Cassis      |
| TI67/458640-067            | Aster       |
| TI69/458640-069            | Cherry      |
| TI70/458640-070            | Vibrant     |
| TI71/458640-071            | Satsuma *   |
| TI72/458640-072            | Maize       |
| TI76/458640-076            | Fossil      |
| TI77/458640-077            | Ash         |
| TI78/458640-078            | Tusk        |
| TI79/458640-079            | Oyster **   |
| TI81/458640-081            | Husk        |
| TI84/458640-084            | Robust      |
| TI85/458640-085            | Beyond      |
| TI86/458640-086            | Voyage *    |
| TI87/458640-087            | Everglade   |
| TI89/458640-089            | Blanch ***  |
| TI90/458640-090            | Longspur    |
| TI91/458640-091            | Vireo       |
| TI92/458640-092            | Dipper      |
| TI93/458640-093            | Gale        |
| TI94/458640-094            | Hunter      |
| TI95/458640-095            | Lime        |
| TI96/458640-096            | Apple       |
| TI97/458640-097            | Krill       |
| TI98/458640-098            | Catalyst    |

\* Colors available on 20-day lead time.

\*\* Colors not available on Eames Molded Fiberglass and Molded Plastic Side Chairs.

\*\*\* Colors not available on Valor Seating.

- Maharam textiles are on assigned lead times [A](#).
- Fabric numbers are listed as Herman Miller fabric number/Maharam fabric number.

## Price Category C

| <b>Manner - Maharam</b>                |              |
|--|--------------|
| Ancillary/Seating/Workspaces           |              |
| 54" wide                               |              |
| 65% post-industrial recycled polyester |              |
| 35% post-consumer recycled polyester   |              |
| Z2701/466177-001                       | Magic        |
| Z2702/466177-002                       | Carob        |
| Z2703/466177-003                       | Porpoise     |
| Z2704/466177-004                       | Flint        |
| Z2705/466177-005                       | Hush *       |
| Z2706/466177-006                       | Nuance       |
| Z2711/466177-011                       | Ember        |
| Z2712/466177-012                       | Wagon        |
| Z2713/466177-013                       | Ablaze       |
| Z2714/466177-014                       | Peel         |
| Z2716/466177-016                       | Butterscotch |
| Z2717/466177-017                       | Harvest      |
| Z2720/466177-020                       | Parakeet     |
| Z2722/466177-022                       | Aquatic      |
| Z2723/466177-023                       | Cottage      |
| Z2724/466177-024                       | Dahlia       |
| Z2725/466177-025                       | Vivid        |
| Z2726/466177-026                       | Basin        |
| Z2727/466177-027                       | Schooner     |
| Z2728/466177-028                       | Slope        |
| Z2729/466177-029                       | Silverpoint  |
| Z2730/466177-030                       | Lattice      |
| Z2731/466177-031                       | Smoky        |
| Z2732/466177-032                       | Magnetic     |
| Z2733/466177-033                       | Woad         |
| Z2734/466177-034                       | Resolute     |
| Z2735/466177-035                       | Cruise       |
| Z2736/466177-036                       | Atmospheric  |
| Z2737/466177-037                       | Cloudburst   |
| Z2738/466177-038                       | Tidewater    |
| Z2739/466177-039                       | Firth        |
| Z2740/466177-040                       | Oceanside    |
| Z2741/466177-041                       | Grandeur     |
| Z2742/466177-042                       | Comfort      |
| Z2743/466177-043                       | Dill         |
| Z2744/466177-044                       | Poplar       |
| Z2745/466177-045                       | Citronella   |
| Z2746/466177-046                       | Passerine    |

| <b>Manner continued</b> |           |
|-------------------------|-----------|
| Z2747/466177-047        | Southwest |
| Z2748/466177-048        | Roseate   |
| Z2749/466177-049        | Charisma  |
| Z2750/466177-050        | Siltstone |
| Z2751/466177-051        | Kimono    |
| Z2752/466177-052        | Valiant   |
| Z2753/466177-053        | Baroness  |

\* Color not available on Eames Aluminum Group, Executive Chairs, Upholstered Molded Plywood Chairs, and Sofa Compact.

| <b>Merit - Maharam</b>                 |            |
|--|------------|
| Ancillary/Seating                      |            |
| 54" wide                               |            |
| 76% post-industrial recycled polyester |            |
| 24% polyester                          |            |
| PFOA-Free stain resistant              |            |
| 88Z01/466444-001                       | Trickle    |
| 88Z02/466444-002                       | Beluga     |
| 88Z03/466444-003                       | Gunmetal   |
| 88Z04/466444-004                       | Blackout   |
| 88Z05/466444-005                       | Superior   |
| 88Z06/466444-006                       | Ocean      |
| 88Z07/466444-007                       | Highborn   |
| 88Z08/466444-008                       | Immersed   |
| 88Z09/466444-009                       | Rainfall   |
| 88Z10/466444-010                       | Blizzard   |
| 88Z11/466444-011                       | Poolside   |
| 88Z12/466444-012                       | Steel      |
| 88Z13/466444-013                       | Zircon     |
| 88Z14/466444-014                       | Ripple     |
| 88Z15/466444-015                       | Aegean     |
| 88Z16/466444-016                       | Armada     |
| 88Z17/466444-017                       | Hedera     |
| 88Z18/466444-018                       | Rainforest |
| 88Z19/466444-019                       | Gator      |
| 88Z20/466444-020                       | Vineyard   |
| 88Z21/466444-021                       | Pine       |
| 88Z22/466444-022                       | Kiwi       |
| 88Z23/466444-023                       | Kookaburra |

| <b>Merit continued</b> |           |
|------------------------|-----------|
| 88Z24/466444-024       | Bellini   |
| 88Z25/466444-025       | Sunflower |
| 88Z26/466444-026       | Sandstorm |
| 88Z27/466444-027       | Mudder    |
| 88Z28/466444-028       | Lynx      |
| 88Z29/466444-029       | Farro     |
| 88Z30/466444-030       | Manila    |
| 88Z31/466444-031       | Starfish  |
| 88Z32/466444-032       | Brass     |
| 88Z33/466444-033       | Arrow     |
| 88Z34/466444-034       | Gelato    |
| 88Z35/466444-035       | Nectarine |
| 88Z36/466444-036       | Macaron   |
| 88Z37/466444-037       | Alert     |
| 88Z38/466444-038       | Goji      |
| 88Z39/466444-039       | Cabernet  |
| 88Z40/466444-040       | Eggplant  |
| 88Z41/466444-041       | Hawk      |
| 88Z42/466444-042       | Stag      |
| 88Z43/466444-043       | Overcast  |

| <b>Metric - Maharam</b>                |           |
|--|-----------|
| Ancillary/Seating/Workspaces           |           |
| 54" wide                               |           |
| 51% post-industrial recycled polyester |           |
| 49% polyester                          |           |
| Z302/466014-002                        | Fog       |
| Z303/466014-003                        | Fleece    |
| Z312/466014-012                        | Cardinal  |
| Z313/466014-013                        | Lava      |
| Z318/466014-018                        | Pollen    |
| Z320/466014-020                        | Alligator |
| Z323/466014-023                        | Tar       |
| Z324/466014-024                        | Anchor    |
| Z326/466014-026                        | Admiral   |
| Z327/466014-027                        | Seaport   |
| Z328/466014-028                        | Scuba     |
| Z329/466014-029                        | Skate     |
| Z330/466014-030                        | Hopscotch |
| Z331/466014-031                        | Film      |
| Z332/466014-032                        | Whale     |
| Z333/466014-033                        | Downpour  |
| Z334/466014-034                        | Midday    |

Price category C continued on next page

# Textile Colors

continued

## Price Category C

continued

| Metric continued |          |
|------------------|----------|
| Z335/466014-035  | Talisman |
| Z336/466014-036  | Hedgerow |
| Z337/466014-037  | Snorkel  |
| Z338/466014-038  | Highway  |
| Z339/466014-039  | Canary   |
| Z340/466014-040  | Sunny    |
| Z341/466014-041  | Aztec    |
| Z342/466014-042  | Fruit    |
| Z343/466014-043  | Galah    |
| Z344/466014-044  | Kiln     |
| Z345/466014-045  | Moth     |

| Murmur - Maharam          |             |
|---------------------------|-------------|
| Ancillary/Seating         |             |
| 55" wide                  |             |
| 100% polyester            |             |
| PFOA-Free stain resistant |             |
| 8EY01/466446-001          | Gust        |
| 8EY02/466446-002          | Harmonica   |
| 8EY03/466446-003          | Canopy      |
| 8EY04/466446-004          | Dim         |
| 8EY05/466446-005          | Peppercorn  |
| 8EY06/466446-006          | Cauldron    |
| 8EY07/466446-007          | Conquer     |
| 8EY08/466446-008          | Rapids      |
| 8EY09/466446-009          | Seawater    |
| 8EY10/466446-010          | Baby        |
| 8EY11/466446-011          | Elderberry  |
| 8EY12/466446-012          | Iceberg     |
| 8EY13/466446-013          | Tallgrass   |
| 8EY14/466446-014          | Underground |
| 8EY15/466446-015          | Biome       |
| 8EY16/466446-016          | Cask        |
| 8EY17/466446-017          | Argan       |
| 8EY18/466446-018          | Sundown     |
| 8EY19/466446-019          | Ignite      |
| 8EY20/466446-020          | Sultry      |
| 8EY21/466446-021          | Sangria     |

## Price Category D

| Bluff - Maharam                   |           |
|-----------------------------------|-----------|
| Ancillary/Seating                 |           |
| 54" wide                          |           |
| 100% polyurethane                 |           |
| Ink-resistant protective top coat |           |
| Polyester backing                 |           |
| 8I801/466489-001                  | Loom      |
| 8I802/466489-002                  | Helm      |
| 8I803/466489-003                  | Cruller   |
| 8I804/466489-004                  | Folklore  |
| 8I805/466489-005                  | Beguile   |
| 8I806/466489-006                  | Sherpa    |
| 8I807/466489-007                  | Teleport  |
| 8I808/466489-008                  | Annex     |
| 8I809/466489-009                  | Lorimer   |
| 8I810/466489-010                  | Cinema    |
| 8I811/466489-011                  | Zip       |
| 8I812/466489-012                  | Coach     |
| 8I813/466489-013                  | Supernova |
| 8I814/466489-014                  | Pirate    |
| 8I815/466489-015                  | Academy   |
| 8I816/466489-016                  | Disco     |
| 8I817/466489-017                  | Equator   |
| 8I818/466489-018                  | Brink     |
| 8I819/466489-019                  | Scene     |
| 8I820/466489-020                  | Petrichor |
| 8I821/466489-021                  | Exotic    |
| 8I822/466489-022                  | Fauna     |
| 8I823/466489-023                  | Calabash  |
| 8I824/466489-024                  | Fuscous   |
| 8I825/466489-025                  | Wildling  |
| 8I826/466489-026                  | Blitz     |
| 8I827/466489-027                  | Allspice  |
| 8I828/466489-028                  | Lumos     |
| 8I829/466489-029                  | Pilot     |
| 8I830/466489-030                  | Jukebox   |
| 8I831/466489-031                  | Dugout    |
| 8I832/466489-032                  | Claret    |
| 8I833/466489-033                  | Flamenco  |

| Mode - Maharam                       |            |
|--------------------------------------|------------|
| Ancillary/Seating/Workspaces         |            |
| 54" wide                             |            |
| 80% post-consumer recycled polyester |            |
| 20% polyester                        |            |
| PFOA-Free stain resistant finish     |            |
| ZMD01/466337-001                     | Stroll     |
| ZMD02/466337-002                     | Intaglio   |
| ZMD03/466337-003                     | Ominous    |
| ZMD04/466337-004                     | Machine    |
| ZMD05/466337-005                     | Talus      |
| ZMD06/466337-006                     | Marsh      |
| ZMD07/466337-007                     | Hollow     |
| ZMD08/466337-008                     | Sycamore   |
| ZMD09/466337-009                     | Clavicle   |
| ZMD10/466337-010                     | Billygoat  |
| ZMD11/466337-011                     | Spindle    |
| ZMD12/466337-012                     | Lemon      |
| ZMD13/466337-013                     | Oxeye      |
| ZMD14/466337-014                     | Henge      |
| ZMD15/466337-015                     | Goldenrod  |
| ZMD16/466337-016                     | Cottontail |
| ZMD17/466337-017                     | Lioness    |
| ZMD18/466337-018                     | Oriole     |
| ZMD19/466337-019                     | Rust       |
| ZMD20/466337-020                     | Carotene   |
| ZMD21/466337-021                     | Blush      |
| ZMD22/466337-022                     | Vermilion  |
| ZMD23/466337-023                     | Alder      |
| ZMD24/466337-024                     | Kermes     |
| ZMD25/466337-025                     | Barberry   |
| ZMD26/466337-026                     | Petal      |
| ZMD27/466337-027                     | Valley     |
| ZMD28/466337-028                     | Odyssey    |
| ZMD29/466337-029                     | Ballpoint  |
| ZMD30/466337-030                     | Toile      |
| ZMD31/466337-031                     | Paradise   |

| Mode continued   |            |
|------------------|------------|
| ZMD32/466337-032 | Angelfish  |
| ZMD33/466337-033 | Denim      |
| ZMD34/466337-034 | Crush      |
| ZMD35/466337-035 | Jetty      |
| ZMD36/466337-036 | Saltwater  |
| ZMD37/466337-037 | Mallard    |
| ZMD38/466337-038 | Celtic     |
| ZMD39/466337-039 | Eucalyptus |
| ZMD40/466337-040 | Bonsai     |
| ZMD41/466337-041 | Sassafras  |
| ZMD42/466337-042 | Yucca      |
| ZMD43/466337-043 | Lichen     |

| Spiral - Maharam |          |
|------------------|----------|
| Workspaces       |          |
| 66" wide         |          |
| 100% polyester   |          |
| ZS301/901882-001 | Chalk    |
| ZS303/901882-003 | Wheat    |
| ZS304/901882-004 | Mica     |
| ZS305/901882-005 | Pavement |
| ZS306/901882-006 | Graphite |

- Maharam textiles are on assigned lead times [A](#).
- Fabric numbers are listed as Herman Miller fabric number/Maharam fabric number.

# Textile Colors

continued

## Price Category E

| Article – Maharam |            |
|-------------------|------------|
| Ancillary/Seating |            |
| 54" wide          |            |
| 100% vinyl        |            |
| ZAT08/458600-008  | Marina     |
| ZAT13/458600-013  | Flume      |
| ZAT14/458600-014  | Storm      |
| ZAT15/458600-015  | Toast      |
| ZAT19/458600-019  | Fleece     |
| ZAT22/458600-022  | Stone      |
| ZAT26/458600-026  | Mercury    |
| ZAT29/458600-029  | Bluegrass  |
| ZAT31/458600-031  | Truffle    |
| ZAT32/458600-032  | Gravel     |
| ZAT33/458600-033  | Value      |
| ZAT34/458600-034  | Tint       |
| ZAT35/458600-035  | Snowflake  |
| ZAT36/458600-036  | Chalice    |
| ZAT37/458600-037  | Trail      |
| ZAT38/458600-038  | Pyramid    |
| ZAT39/458600-039  | Desert     |
| ZAT40/458600-040  | Lei        |
| ZAT41/458600-041  | Rouge      |
| ZAT42/458600-042  | Karma      |
| ZAT43/458600-043  | Opal       |
| ZAT44/458600-044  | Periwinkle |
| ZAT45/458600-045  | Vampire    |
| ZAT46/458600-046  | Surf       |
| ZAT47/458600-047  | Plumage    |

| Flock - Maharam  |           |
|------------------|-----------|
| Workspaces       |           |
| 63" wide         |           |
| 100% polyester   |           |
| ZF301/901892-001 | Calm      |
| ZF302/901892-002 | Course    |
| ZF303/901892-003 | Highlight |
| ZF305/901892-005 | Poppy     |
| ZF306/901892-006 | Briefcase |
| ZF307/901892-007 | Monkstrap |
| ZF308/901892-008 | Quag      |
| ZF309/901892-009 | Pistachio |
| ZF310/901892-010 | Froth     |
| ZF311/901892-011 | Celadon   |
| ZF312/901892-012 | Highsea   |
| ZF313/901892-013 | China     |
| ZF314/901892-014 | Victorian |
| ZF315/901892-015 | Commander |
| ZF316/901892-016 | Raven     |
| ZF317/901892-017 | Aluminum  |

| Micro – Maharam  |           |
|------------------|-----------|
| Ancillary        |           |
| 54" wide         |           |
| 100% vinyl       |           |
| ZMB01/466099-001 | Muslin    |
| ZMB04/466099-004 | Basalt    |
| ZMB06/466099-006 | Phantom   |
| ZMB07/466099-007 | Depth     |
| ZMB08/466099-008 | Cottage   |
| ZMB09/466099-009 | Hunter    |
| ZMB11/466099-011 | Tomatillo |
| ZMB12/466099-012 | Brew      |
| ZMB14/466099-014 | Tang      |
| ZMB15/466099-015 | Risk      |

| Parallel – Maharam      |          |
|-------------------------|----------|
| Workspaces              |          |
| 66" wide                |          |
| 100% recycled polyester |          |
| TT03/901180-003         | Fog      |
| TT22/901180-022         | Sterling |
| TT23/901180-023         | Linen    |
| TT24/901180-024         | Pea      |
| TT27/901180-027         | Boulder  |
| TT28/901180-028         | Stream   |
| TT29/901180-029         | Shiitake |
| TT32/901180-032         | Brandy   |
| TT33/901180-033         | Crater   |
| TT36/901180-036         | Quail    |

## Price Category F

| Apt – Maharam                     |               |
|-----------------------------------|---------------|
| Ancillary/Seating                 |               |
| 54" wide                          |               |
| 100% polyurethane/silicone        |               |
| Ink-resistant protective top coat |               |
| Polyester backing                 |               |
| 82T12/466392-012                  | Iris          |
| 82T13/466392-013                  | Nocturnal     |
| 82T14/466392-014                  | Fluid         |
| 82T15/466392-015                  | Eden          |
| 82T16/466392-016                  | Galactic      |
| 82T17/466392-017                  | Shoreline     |
| 82T18/466392-018                  | Jade          |
| 82T19/466392-019                  | Garden        |
| 82T20/466392-020                  | Botanic       |
| 82T21/466392-021                  | Chartreuse    |
| 82T23/466392-023                  | Lyric         |
| 82T24/466392-024                  | Turmeric      |
| 82T25/466392-025                  | Bengal        |
| 82T26/466392-026                  | Core          |
| 82T27/466392-027                  | Mantle        |
| 82T28/466392-028                  | Sorbet        |
| 82T32/466392-032                  | Oak           |
| 82T33/466392-033                  | Castle        |
| 82T34/466392-034                  | Follow        |
| 82T35/466392-035                  | Elixir        |
| 82T36/466392-036                  | Charm         |
| 82T37/466392-037                  | Descend       |
| 82T38/466392-009                  | Sketch        |
| 82T39/466392-010                  | Glacier       |
| 82T40/466392-031                  | Fortress      |
| 82T41/466392-030                  | Lotus         |
| 82T42/466392-001                  | Coconut       |
| 82T43/466392-011                  | Cobblestone   |
| 82T44/466392-029                  | Bloom         |
| 82T45/466392-022                  | Crepe         |
| 82T46/466392-006                  | Hickory       |
| 82T47/466392-007                  | Constellation |
| 82T48/466392-008                  | Labyrinth     |
| 82T49/466392-002                  | Vibe          |
| 82T50/466392-003                  | Stampede      |
| 82T51/466392-004                  | Lumber        |
| 82T52/466392-005                  | Gingerbread   |

Appendix: Textile Colors

- Maharam textiles are on assigned lead times [A](#).
- Fabric numbers are listed as Herman Miller fabric number/Maharam fabric number.

Price category F continued on next page

# Textile Colors

continued

## Price Category F

continued

Appendix: Textile Colors

| Brindle - Maharam         |            |
|---------------------------|------------|
| Ancillary/Seating         |            |
| 58" wide                  |            |
| 100% polyester            |            |
| PFOA-free stain resistant |            |
| Acrylic backing           |            |
| 87101/466418-001          | Calico     |
| 87102/466418-002          | Mauve      |
| 87103/466418-003          | Torch      |
| 87104/466418-004          | Burnt      |
| 87105/466418-005          | Barn       |
| 87106/466418-006          | Pharaoh    |
| 87107/466418-007          | Sandbur    |
| 87108/466418-008          | Jungle     |
| 87109/466418-009          | Inland     |
| 87110/466418-009          | Seagrass   |
| 87111/466418-009          | Watercolor |
| 87112/466418-009          | Aquarium   |
| 87113/466418-009          | Drill      |

| Chime - Maharam |            |
|-----------------|------------|
| Ancillary       |            |
| 54" wide        |            |
| 100% vinyl      |            |
| V9M3/465350-003 | Morel      |
| V9MB/465350-011 | Tranquil   |
| V9M/465350-020  | Slate      |
| V9MV/465350-031 | Verve      |
| V9MW/465350-032 | Understory |

| Conduit - Maharam         |           |
|---------------------------|-----------|
| Ancillary/Seating         |           |
| 58" wide                  |           |
| 100% polyester            |           |
| PFOA-free stain resistant |           |
| Acrylic backing           |           |
| 87Z01/466428-001          | Space     |
| 87Z02/466428-002          | Syrup     |
| 87Z03/466428-003          | Nimbus    |
| 87Z04/466428-004          | Greystone |
| 87Z05/466428-005          | Fawn      |
| 87Z06/466428-006          | Ghost     |
| 87Z07/466428-007          | Caribbean |
| 87Z08/466428-008          | Canal     |
| 87Z09/466428-009          | Bonfire   |

| Emit - Maharam                         |           |
|--|-----------|
| Workspaces                             |           |
| 54" wide                               |           |
| 55% post-industrial recycled polyester |           |
| 45% post-consumer recycled polyester   |           |
| PFOA-free stain resistant              |           |
| 8EX01/466378-001                       | Wed       |
| 8EX02/466378-002                       | Zebra     |
| 8EX03/466378-003                       | Chiffon   |
| 8EX05/466378-005                       | Nectar    |
| 8EX06/466378-006                       | Elk       |
| 8EX08/466378-008                       | Goldenrod |
| 8EX09/466378-009                       | Beached   |
| 8EX10/466378-010                       | Samba     |
| 8EX11/466378-011                       | Nest      |
| 8EX14/466378-014                       | Groove    |
| 8EX17/466378-017                       | Haiku     |
| 8EX18/466378-018                       | Bluefin   |
| 8EX19/466378-019                       | Flow      |
| 8EX20/466378-020                       | Xenon     |
| 8EX21/466378-021                       | Artem     |
| 8EX22/466378-022                       | Zen       |
| 8EX25/466378-025                       | Limeade   |

| Instill - Maharam                 |             |
|-----------------------------------|-------------|
| Ancillary/Seating                 |             |
| 54" wide                          |             |
| 100% polyurethane                 |             |
| Ink-resistant protective top coat |             |
| Polyester backing                 |             |
| 74M01/466351-001                  | Page        |
| 74M02/466351-002                  | Limestone   |
| 74M03/466351-003                  | Bobwhite    |
| 74M04/466351-004                  | Loafer      |
| 74M07/466351-007                  | Shaker      |
| 74M08/466351-008                  | Doe         |
| 74M09/466351-009                  | Ride        |
| 74M10/466351-010                  | Squire      |
| 74M11/466351-011                  | Tannin      |
| 74M12/466351-012                  | Vitis       |
| 74M14/466351-014                  | Quail       |
| 74M15/466351-015                  | Brittanic   |
| 74M16/466351-016                  | Narwhal     |
| 74M18/466351-018                  | Stowaway    |
| 74M19/466351-019                  | Koala       |
| 74M20/466351-020                  | Dorsal      |
| 74M21/466351-021                  | Stealth     |
| 74M22/466351-022                  | Mosey       |
| 74M23/466351-023                  | Beachfront  |
| 74M24/466351-024                  | Discovery   |
| 74M25/466351-025                  | Grasp       |
| 74M26/466351-026                  | Arboreous   |
| 74M27/466351-027                  | Yearling    |
| 74M28/466351-028                  | Allele      |
| 74M29/466351-029                  | Eager       |
| 74M30/466351-030                  | Rise        |
| 74M31/466351-031                  | Latte       |
| 74M32/466351-032                  | Compose     |
| 74M33/466351-033                  | Furrow      |
| 74M34/466351-034                  | Tenor       |
| 74M35/466351-035                  | Annatto     |
| 74M36/466351-036                  | Together    |
| 74M37/466351-037                  | Intention   |
| 74M38/466351-038                  | Overnight   |
| 74M39/466351-039                  | Icecap      |
| 74M40/466351-040                  | Metamorphic |
| 74M41/466351-041                  | Anthracite  |

| Keen - Maharam            |            |
|---------------------------|------------|
| Ancillary/Seating         |            |
| 54" wide                  |            |
| 61% polyester             |            |
| 39% polyolefin            |            |
| PFOA-Free stain resistant |            |
| Acrylic backing           |            |
| 89N01/466433-001          | Gaur       |
| 89N02/466433-002          | Lock       |
| 89N03/466433-003          | Elk        |
| 89N04/466433-004          | Oatmeal    |
| 89N05/466433-005          | Lakefront  |
| 89N06/466433-006          | Argent     |
| 89N07/466433-007          | Coyote     |
| 89N08/466433-008          | Eventide   |
| 89N09/466433-009          | Canal      |
| 89N10/466433-010          | Rosemary   |
| 89N11/466433-011          | Herb       |
| 89N12/466433-012          | Ruby       |
| 89N13/466433-013          | Loganberry |

| Ledger - Maharam  |     |
|-------------------|-----|
| Ancillary/Seating |     |
| 54" wide          |     |
| 100% polyurethane |     |
| V9G1/463770-001   | 001 |
| V9G2/463770-002   | 002 |
| V9G3/463770-003   | 003 |
| V9G4/463770-004   | 004 |
| V9GG/463770-017   | 017 |
| V9GQ/463770-025   | 025 |
| V9GS/463770-026   | 026 |
| V9GU/463770-028   | 028 |
| V9GV/463770-029   | 029 |
| V9GW/463770-030   | 030 |
| V9GX/463770-031   | 031 |
| V9GY/463770-032   | 032 |
| V9G18/463770-042  | 042 |
| V9G19/463770-043  | 043 |
| V9G20/463770-044  | 044 |
| V9G21/463770-045  | 045 |
| V9G22/463770-046  | 046 |

Price category F continued on next page

- Maharam textiles are on assigned lead times [A](#).
- Fabric numbers are listed as Herman Miller fabric number/Maharam fabric number.



# Textile Colors

continued

## Price Category F

continued

| Loop - Maharam                         |             |
|--|-------------|
| Ancillary/Seating                      |             |
| 57" wide                               |             |
| 48% post-industrial recycled polyester |             |
| 26% polyester                          |             |
| 26% post-consumer recycled polyester   |             |
| PFOA-Free stain resistant              |             |
| Acrylic Backing                        |             |
| ZLL01/466469-001                       | Opossum     |
| ZLL02/466469-002                       | Foundation  |
| ZLL03/466469-003                       | Naval       |
| ZLL04/466469-004                       | Buoyant     |
| ZLL05/466469-005                       | Mockingbird |
| ZLL06/466469-006                       | Dynasty     |
| ZLL07/466469-007                       | Zori        |
| ZLL08/466469-008                       | Wildfire    |
| ZLL09/466469-009                       | Floral      |
| ZLL10/466469-010                       | Penguin     |

| Multiply - Maharam                     |          |
|--|----------|
| Ancillary/Seating                      |          |
| 58" wide                               |          |
| 57% post-consumer recycled polyester   |          |
| 43% post-industrial recycled polyester |          |
| PFOA-Free stain resistant              |          |
| Acrylic Backing                        |          |
| 82A01/466341-001                       | Winter   |
| 82A02/466341-002                       | Encore   |
| 82A03/466341-003                       | Swing    |
| 82A04/466341-004                       | Contrast |
| 82A05/466341-005                       | Sterling |
| 82A06/466341-006                       | Daze     |
| 82A07/466341-007                       | Sway     |
| 82A08/466341-008                       | Sailor   |
| 82A09/466341-009                       | Mystique |
| 82A10/466341-010                       | Deep     |
| 82A11/466341-011                       | Craft    |
| 82A12/466341-012                       | Town     |
| 82A13/466341-013                       | Limit    |
| 82A14/466341-014                       | Tamale   |

| Pitch - Maharam  |            |
|------------------|------------|
| Ancillary        |            |
| 54" wide         |            |
| 100% vinyl       |            |
| ZPC04/466186-004 | Pollen     |
| ZPC07/466186-007 | Apple      |
| ZPC11/466186-011 | Voyage     |
| ZPC12/466186-012 | Turquoise  |
| ZPC14/466186-014 | Inlet      |
| ZPC15/466186-015 | Captain    |
| ZPC16/466186-016 | Aura       |
| ZPC17/466186-017 | Coastal    |
| ZPC18/466186-018 | Fog        |
| ZPC19/466186-019 | Coal       |
| ZPC21/466186-021 | Mulberry   |
| ZPC24/466186-024 | Flame      |
| ZPC26/466186-026 | Tumbleweed |
| ZPC29/466186-029 | Subtle     |
| ZPC30/466186-030 | Buff       |

| Pepper - Maharam                       |           |
|--|-----------|
| Ancillary/Seating                      |           |
| 58" wide                               |           |
| 49% polyester                          |           |
| 41% post-industrial recycled polyester |           |
| 10% post-consumer recycled polyester   |           |
| PFOA-Free stain resistant              |           |
| Acrylic Backing                        |           |
| 8LW01/466486-001                       | Dojo      |
| 8LW02/466486-002                       | Marengo   |
| 8LW03/466486-003                       | Harlequin |
| 8LW04/466486-004                       | Pavlova   |
| 8LW06/466486-006                       | Achiote   |
| 8LW07/466486-007                       | Essence   |
| 8LW08/466486-008                       | Genome    |
| 8LW09/466486-009                       | Myriad    |
| 8LW10/466486-010                       | Terrarium |

| Scuba - Maharam   |            |
|-------------------|------------|
| Ancillary         |            |
| 54" wide          |            |
| 100% polyurethane |            |
| V9B1/464930-001   | Vanilla    |
| V9B5/464930-005   | Chinchilla |
| V9B6/464930-006   | Mahogany   |
| V9B7/464930-007   | Jet        |
| V9B8/464930-008   | Charcoal   |
| V9B9/464930-009   | Dolphin    |
| V9BA/464930-010   | Drizzle    |
| V9BC/464930-012   | Conifer    |
| V9BD/464930-013   | Bottle     |
| V9BF/464930-015   | Tourmaline |
| V9BG/464930-016   | Sapphire   |
| V9BH/464930-017   | Electric   |
| V9BL/464930-020   | Cabernet   |
| V9BM/464930-021   | Brick      |
| V9BN/464930-022   | Coral      |
| V9BP/464930-023   | Autumn     |

| Strum - Maharam                                   |            |
|---|------------|
| Ancillary/Seating                                 |            |
| 54" wide  |            |
| 100% polyurethane with silane-based antimicrobial |            |
| Z3301/466122-001                                  | Overcast   |
| Z3302/466122-002                                  | Ridge      |
| Z3304/466122-004                                  | Pigeon     |
| Z3307/466122-007                                  | Bur        |
| Z3308/466122-008                                  | Abalone    |
| Z3312/466122-012                                  | Lemongrass |

## Price Category G

| Compound - Maharam                                |              |
|---|--------------|
| Ancillary/Seating                                 |              |
| 54" wide  |              |
| 100% polyurethane with silane-based antimicrobial |              |
| ZC201/466196-001                                  | Quartz       |
| ZC203/466196-003                                  | Weathered    |
| ZC204/466196-004                                  | Cliff        |
| ZC205/466196-005                                  | Espresso     |
| ZC206/466196-006                                  | Smolder      |
| ZC207/466196-007                                  | Blaze        |
| ZC208/466196-008                                  | Mandarin     |
| ZC209/466196-009                                  | Maple        |
| ZC210/466196-010                                  | Perennial    |
| ZC211/466196-011                                  | Mountainside |
| ZC212/466196-012                                  | Tundra       |
| ZC213/466196-013                                  | Manatee      |
| ZC214/466196-014                                  | Marine       |
| ZC215/466196-015                                  | Twilight     |
| ZC216/466196-016                                  | Shelter      |
| ZC217/466196-017                                  | Vessel       |
| ZC218/466196-018                                  | Smoke        |
| ZC219/466196-019                                  | Fog          |

| Fluent Crypton - Maharam               |        |
|--|--------|
| Ancillary                              |        |
| 54" wide                               |        |
| 52% polyester                          |        |
| 31% post-industrial recycled polyester |        |
| 17% post-consumer recycled polyester   |        |
| ZFC01/466073-001                       | Lynx   |
| ZFC12/466073-012                       | Bayou  |
| ZFC13/466073-013                       | Bottle |
| ZFC14/466073-014                       | Cadet  |
| ZFC22/466073-022                       | Turf   |
| ZFC24/466073-024                       | Steady |

Price category G continued on next page

Appendix: Textile Colors

- Maharam textiles are on assigned lead times [A](#).
- Fabric numbers are listed as Herman Miller fabric number/Maharam fabric number.

# Textile Colors

continued

Appendix: Textile Colors

## Price Category G

continued

| Fold - Maharam    |          |
|-------------------|----------|
| Seating           |          |
| 54" wide          |          |
| 100% polyurethane |          |
| Polyester backing |          |
| ZF101/466292-001  | Jet      |
| ZF102/466292-002  | Chalk    |
| ZF103/466292-003  | Smoke    |
| ZF105/466292-005  | Fatigue  |
| ZF106/466292-006  | Splash   |
| ZF107/466292-007  | Apple    |
| ZF108/466292-008  | Moss     |
| ZF110/466292-010  | Midnight |

| Gild - Maharam                    |            |
|-----------------------------------|------------|
| Ancillary/Seating                 |            |
| 54" wide                          |            |
| 100% non-phthalate vinyl          |            |
| Ink-resistant protective top coat |            |
| Polyester backing                 |            |
| 8AR01/466432-005                  | Grapevine  |
| 8AR02/466432-009                  | Frosting   |
| 8AR03/466432-007                  | Smokey     |
| 8AR04/466432-003                  | Skylight   |
| 8AR05/466432-011                  | Sandstone  |
| 8AR06/466432-004                  | Hurricane  |
| 8AR07/466432-002                  | Wreath     |
| 8AR08/466432-001                  | Rainforest |
| 8AR09/466432-012                  | Fudge      |
| 8AR10/466432-010                  | Lantern    |
| 8AR11/466432-006                  | Planet     |
| 8AR12/466432-008                  | Reflection |

| Pare - Maharam                   |            |
|----------------------------------|------------|
| Ancillary/Seating                |            |
| 54" wide                         |            |
| 52% wool                         |            |
| 26% polyester                    |            |
| 22% nylon                        |            |
| PFOA-free stain resistant finish |            |
| ZPR01/466359-001                 | Polaris    |
| ZPR04/466359-004                 | Fresco     |
| ZPR06/466359-006                 | Wink       |
| ZPR07/466359-007                 | Concord    |
| ZPR08/466359-008                 | Strawberry |
| ZPR09/466359-009                 | Solar      |
| ZPR10/466359-010                 | Amulet     |
| ZPR11/466359-011                 | Zest       |
| ZPR12/466359-012                 | Elmwood    |
| ZPR13/466359-013                 | Thyme      |
| ZPR17/466359-017                 | Blueberry  |

| Runner - Maharam                       |           |
|--|-----------|
| Ancillary/Seating                      |           |
| 54" wide                               |           |
| 57% post-industrial recycled polyester |           |
| 43% post-consumer recycled polyester   |           |
| ZRF01/466108-001                       | Bluff     |
| ZRF03/466108-003                       | Grove     |
| ZRF04/466108-004                       | Starboard |
| ZRF05/466108-005                       | Plot      |
| ZRF06/466108-006                       | Carousel  |

| Sudden - Maharam  |     |
|-------------------|-----|
| Ancillary         |     |
| 54" wide          |     |
| 100% polyurethane |     |
| ZSD02/463000-002  | 002 |
| ZSD03/463000-003  | 003 |
| ZSD05/463000-005  | 005 |
| ZSD06/463000-006  | 006 |
| ZSD07/463000-007  | 007 |
| ZSD08/463000-008  | 008 |
| ZSD09/463000-009  | 009 |
| ZSD10/463000-010  | 010 |
| ZSD11/463000-011  | 011 |
| ZSD13/463000-013  | 013 |
| ZSD15/463000-015  | 015 |
| ZSD16/463000-016  | 016 |
| ZSD17/463000-017  | 017 |
| ZSD18/463000-018  | 018 |
| ZSD19/463000-019  | 019 |
| ZSD20/463000-020  | 020 |
| ZSD24/463000-024  | 024 |
| ZSD27/463000-027  | 027 |
| ZSD36/463000-036  | 036 |

## Price Category H

| Anagram - Maharam |          |
|-------------------|----------|
| Ancillary         |          |
| 54" wide          |          |
| 42% cotton        |          |
| 32% polyester     |          |
| 26% nylon         |          |
| ZAN01/466067-001  | Quarry   |
| ZAN02/466067-002  | Hush     |
| ZAN03/466067-003  | Electric |
| ZAN04/466067-004  | Range    |
| ZAN05/466067-005  | Settle   |

| Circles - Maharam |          |
|-------------------|----------|
| Ancillary/Seating |          |
| 55" wide          |          |
| 70% cotton        |          |
| 30% polyester     |          |
| ZT01/458310-001   | Khaki    |
| ZT02/458310-002   | Fatigue  |
| ZT03/458310-003   | Document |
| ZT04/458310-004   | Engine   |

| Dot Pattern - Maharam |          |
|-----------------------|----------|
| Ancillary/Seating     |          |
| 55" wide              |          |
| 71% cotton            |          |
| 29% polyester         |          |
| ZK01/458300-001       | Document |
| ZK02/458300-002       | Taupe    |
| ZK04/458300-004       | Red      |
| ZK05/458300-005       | Navy     |

| Mechanism - Maharam |           |
|---------------------|-----------|
| Ancillary           |           |
| 54" wide            |           |
| 100% polyester      |           |
| ZMC01/465952-001    | Mercury   |
| ZMC10/465952-010    | Pearl     |
| ZMC11/465952-011    | Bronze    |
| ZMC13/465952-013    | Titanium  |
| ZMC15/465952-015    | Tangerine |
| ZMC17/465952-017    | Sprout    |

Price category H continued on next page

- Maharam textiles are on assigned lead times [A](#).
- Fabric numbers are listed as Herman Miller fabric number/Maharam fabric number.

# Textile Colors

continued

## Price Category H

continued

| Mister – Maharam            |  |
|-----------------------------|--|
| Ancillary                   |  |
| 54" wide                    |  |
| 67% solution-dyed acrylic   |  |
| 33% solution-dyed polyester |  |
| ZMG01/466178-001 Breeze     |  |
| ZMG04/466178-004 Enliven    |  |
| ZMG05/466178-005 Notice     |  |
| ZMG06/466178-006 Azurite    |  |

| Regatta – Maharam           |  |
|-----------------------------|--|
| Ancillary                   |  |
| 54" wide                    |  |
| 65% solution-dyed acrylic   |  |
| 35% solution-dyed polyester |  |
| ZRT01/466189-001 Drift      |  |
| ZRT02/466189-002 Parasol    |  |
| ZRT04/466189-004 Swell      |  |

| Small Dot Pattern – Maharam |  |
|-----------------------------|--|
| Ancillary/Seating           |  |
| 55" wide                    |  |
| 71% cotton                  |  |
| 29% polyester               |  |
| ZL01/458320-001 Document    |  |
| ZL02/458320-002 Sand        |  |
| ZL03/458320-003 Khaki       |  |
| ZL04/458320-004 Taupe       |  |
| ZL05/458320-005 Charcoal    |  |
| ZL06/458320-006 Document    |  |
| Reverse                     |  |
| ZL07/458320-007 Red         |  |
| ZL08/458320-008 Yellow      |  |
| ZL09/458320-009 Green       |  |

## Price Category I

| Colorwheel – Maharam           |  |
|--------------------------------|--|
| Ancillary                      |  |
| 54" wide                       |  |
| 62% cotton                     |  |
| 38% solution-dyed              |  |
| post-industrial recycled nylon |  |
| ZCW02/466163-002 Pumice        |  |
| ZCW03/466163-003 Viridian      |  |
| ZCW06/466163-006 Charcoal      |  |
| ZCW07/466163-007 Carbon        |  |

| Cursive – Maharam           |  |
|-----------------------------|--|
| Ancillary/Seating           |  |
| 54" wide                    |  |
| 67% solution-dyed acrylic   |  |
| 33% solution-dyed polyester |  |
| PFOA-Free stain resistant   |  |
| 7CW01/466335-001 Fast       |  |
| 7CW03/466335-003 Beachcomb  |  |
| 7CW05/466335-005 Swift      |  |
| 7CW07/466335-007 Inkwell    |  |
| 7CW08/466335-008 Rubber     |  |

| Passage - Maharam           |  |
|-----------------------------|--|
| Ancillary                   |  |
| 54" wide                    |  |
| 100% polyester              |  |
| 59P01/466614-001 Mirage     |  |
| 59P02/466614-002 Poolside   |  |
| 59P03/466614-003 Cascade    |  |
| 59P04/466614-004 Lacinato   |  |
| 59P05/466614-005 Overstory  |  |
| 59P06/466614-006 Celadon    |  |
| 59P07/466614-007 Echo       |  |
| 59P08/466614-008 Bentonite  |  |
| 59P09/466614-009 Buttercup  |  |
| 59P10/466614-010 Maple      |  |
| 59P11/466614-011 Blossom    |  |
| 59P12/466614-012 Cloudberry |  |
| 59P13/466614-013 Contessa   |  |
| 59P14/466614-014 Claret     |  |
| 59P15/466614-015 Katana     |  |

| Study - Maharam             |  |
|-----------------------------|--|
| Ancillary/Seating           |  |
| 54" wide                    |  |
| 73% solution-dyed acrylic   |  |
| 27% solution-dyed polyester |  |
| ZSY01/466269-001 001        |  |
| ZSY02/466269-002 002        |  |
| ZSY03/466269-003 003        |  |
| ZSY04/466269-004 004        |  |
| ZSY05/466269-005 005        |  |

| Tracery – Maharam                |  |
|----------------------------------|--|
| Ancillary                        |  |
| 52" wide                         |  |
| 34% solution-dyed nylon          |  |
| 26% wool                         |  |
| 21% polyester                    |  |
| 19% cotton                       |  |
| acrylic backing                  |  |
| PFOA-free stain resistant finish |  |
| ZT501/466372-001 Birch           |  |
| ZT502/466372-002 Sterling        |  |
| ZT503/466372-003 Flint           |  |
| ZT504/466372-004 Indigo          |  |
| ZT505/466372-005 Arctic          |  |
| ZT506/466372-006 Kelp            |  |
| ZT507/466372-007 Melon           |  |
| ZT508/466372-008 Poppy           |  |
| ZT509/466372-009 Copper          |  |
| ZT510/466372-010 Papaya          |  |
| ZT511/466372-011 Sepia           |  |

## Price Category J

| Fluted Silk – Maharam     |  |
|---------------------------|--|
| Ancillary                 |  |
| 54" wide                  |  |
| 85% silk                  |  |
| 8% cotton                 |  |
| 7% acrylic                |  |
| ZFK02/465982-002 Tarnish  |  |
| ZFK05/465982-005 Calm     |  |
| ZFK06/465982-006 Flaxen   |  |
| ZFK10/465982-010 Noticed  |  |
| ZFK11/465982-011 Moody    |  |
| ZFK12/465982-012 Constant |  |
| ZFK13/465982-013 Seed     |  |
| ZFK14/465982-014 Eternal  |  |
| ZFK15/465982-015 Honor    |  |
| ZFK17/465982-017 Cranach  |  |
| ZFK20/465982-020 Discreet |  |

| Mikado – Maharam             |  |
|------------------------------|--|
| Ancillary                    |  |
| 54" wide                     |  |
| 79% cotton                   |  |
| 21% polyester                |  |
| V1901/459330-001 Umber       |  |
| V1902/459330-002 Orange      |  |
| V1903/459330-003 Ultramarine |  |
| V1904/459330-004 Pink        |  |
| V1905/459330-005 Sepia       |  |

Price category J continued on next page

- Maharam textiles are on assigned lead times [A](#).
- Fabric numbers are listed as Herman Miller fabric number/Maharam fabric number.

# Textile Colors

continued

Appendix: Textile Colors

## Price Category J

continued

| Trestle - Maharam |          |
|-------------------|----------|
| Ancillary         |          |
| 54" wide          |          |
| 36% acrylic       |          |
| 32% wool          |          |
| 23% cotton        |          |
| 9% polyester      |          |
| 3WG01/466613-001  | Loam     |
| 3WG02/466613-002  | Rift     |
| 3WG03/466613-003  | Fuse     |
| 3WG04/466613-004  | Cumulus  |
| 3WG05/466613-005  | Strand   |
| 3WG06/466613-006  | Pomelo   |
| 3WG07/466613-007  | Tawny    |
| 3WG08/466613-008  | Sunstone |
| 3WG09/466613-009  | Kindling |
| 3WG10/466613-010  | Sidecar  |
| 3WG11/466613-011  | Beak     |
| 3WG12/466613-012  | Ficus    |
| 3WG13/466613-013  | Hinge    |
| 3WG14/466613-014  | Bluefish |
| 3WG15/466613-015  | Oblivion |

## Price Category K

| Checker – Maharam |                           |
|-------------------|---------------------------|
| Ancillary         |                           |
| 55" wide          |                           |
| 77% cotton        |                           |
| 23% polyester     |                           |
| V1201/459830-001  | Emerald Light/<br>Ivory   |
| V1204/459830-004  | Ultramarine/<br>Emerald   |
| V1206/459830-007  | Sienna Dark/<br>Khaki     |
| V1207/459830-008  | Black/White               |
| V1209/459830-009  | Ultramarine/<br>Turquoise |
| V1210/459830-010  | Blue Gray/<br>Emerald     |
| V1211/459830-011  | Olive/Pink                |
| V1212/459830-012  | Magenta/<br>Orange        |
| V1213/459830-013  | Crimson/<br>Orange        |

| Checker Split – Maharam |             |
|-------------------------|-------------|
| Ancillary               |             |
| 55" wide                |             |
| 77% cotton              |             |
| 23% polyester           |             |
| V1301/460290-01         | Black/White |

| Double Triangles – Maharam |             |
|----------------------------|-------------|
| Ancillary                  |             |
| 55" wide                   |             |
| 77% cotton                 |             |
| 23% polyester              |             |
| V1401/459840-001           | Black/White |

| Facets – Maharam |             |
|------------------|-------------|
| Ancillary        |             |
| 55" wide         |             |
| 77% cotton       |             |
| 23% polyester    |             |
| V1501/459850-001 | Black/White |

| Isa – Maharam    |          |
|------------------|----------|
| Ancillary        |          |
| 59" wide         |          |
| 85% wool         |          |
| 15% nylon        |          |
| VKZ01/466624-001 | Bashful  |
| VKZ02/466624-002 | Median   |
| VKZ03/466624-003 | Observe  |
| VKZ04/466624-004 | Plains   |
| VKZ05/466624-005 | Drawn    |
| VKZ06/466624-006 | Connect  |
| VKZ07/466624-007 | Fennel   |
| VKZ08/466624-008 | Skyward  |
| VKZ09/466624-009 | Oceanic  |
| VKZ10/466624-010 | Neptune  |
| VKZ11/466624-011 | Sprint   |
| VKZ12/466624-012 | Ledge    |
| VKZ13/466624-013 | Surround |
| VKZ14/466624-014 | Foretell |
| VKZ15/466624-015 | Lory     |
| VKZ16/466624-016 | Dear     |
| VKZ17/466624-017 | Foxtrot  |
| VKZ18/466624-018 | Sincere  |
| VKZ19/466624-019 | Begonia  |

| Optik – Maharam  |                       |
|------------------|-----------------------|
| Ancillary        |                       |
| 55" wide         |                       |
| 76% cotton       |                       |
| 24% polyester    |                       |
| ZQP01/459960-001 | Sun Yellow/<br>Orange |
| ZQP06/459960-006 | White/Black           |

| Unisol – Maharam |                 |
|------------------|-----------------|
| Ancillary        |                 |
| 55" wide         |                 |
| 61% rayon        |                 |
| 21% polyester    |                 |
| 18% cotton       |                 |
| ZUN01/461160-001 | Black/<br>White |

## Price Category L

| Exaggerated Plaid – Maharam |       |
|-----------------------------|-------|
| Ancillary                   |       |
| 59" wide                    |       |
| 100% wool                   |       |
| ZEP01/466039-001            | Glen  |
| ZEP02/466039-002            | Brae  |
| ZEP03/466039-003            | Firth |

| Geometri – Maharam |                 |
|--------------------|-----------------|
| Ancillary          |                 |
| 55" wide           |                 |
| 77% cotton         |                 |
| 23% polyester      |                 |
| ZGM02/459970-002   | Red/<br>Carmine |
| ZGM03/459970-003   | Lilac/Blue      |
| ZGM04/459970-004   | White/<br>Black |

| Jacobs Coat – Maharam |                          |
|-----------------------|--------------------------|
| Ancillary             |                          |
| 54" wide              |                          |
| 92% wool              |                          |
| 8% nylon              |                          |
| V1601/462270-001      | Multicolored<br>Bright * |
| V1602/462270-002      | Multicolored<br>Neutral  |

\* Color available on Girard Color Wheel Ottoman.

| Millerstripe – Maharam |                         |
|------------------------|-------------------------|
| Ancillary              |                         |
| 54" wide               |                         |
| 92% wool               |                         |
| 8% rayon               |                         |
| V1701/462250-001       | Multicolored<br>Bright  |
| V1702/462250-002       | Multicolored<br>Neutral |

Price category L continued on next page

- Maharam textiles are on assigned lead times **A**.
- Fabric numbers are listed as Herman Miller fabric number/Maharam fabric number.

# Textile Colors

continued

## Price Category L

continued

| Minicheck - Maharam              |
|----------------------------------|
| Seating                          |
| 55" wide                         |
| 78% cotton                       |
| 22% polyester                    |
| PFOA-Free stain resistant finish |
| ZMK01/466268-001 Black/<br>White |

| Monk's Wool – Maharam     |
|---------------------------|
| Ancillary                 |
| 54" wide                  |
| 96% wool                  |
| 4% nylon                  |
| ZMW01/457301-001 Tusk     |
| ZMW03/457301-003 Slate    |
| ZMW05/457301-005 Cherokee |

| Pebble Wool – Maharam     |
|---------------------------|
| Ancillary                 |
| 54" wide                  |
| 90% wool                  |
| 10% nylon                 |
| ZPW01/457401-001 Birch    |
| ZPW10/457401-010 Cottage  |
| ZPW13/457401-013 Eggshell |
| ZPW14/457401-014 Whisper  |
| ZPW15/457401-015 Ceramic  |
| ZPW16/457401-016 Seamist  |
| ZPW17/457401-017 Armory   |
| ZPW18/457401-018 Glaze    |
| ZPW19/457401-019 Cordial  |

| Pebble Wool Multi – Maharam |
|-----------------------------|
| Ancillary                   |
| 54" wide                    |
| 97% wool                    |
| 3% nylon                    |
| ZPM01/461200-001 Fawn       |
| ZPM02/461200-002 Slate      |
| ZPM05/461200-005 Moss       |
| ZPM06/461200-006 Tabasco    |

| Quatrefoil – Maharam     |
|--------------------------|
| Ancillary                |
| 54" wide                 |
| 75% cotton               |
| 25% nylon                |
| V2101/459350-001 Silver  |
| V2102/459350-002 Pink    |
| V2103/459350-003 Crimson |
| V2104/459350-004 Emerald |
| V2105/459350-005 Violet  |

| Repeat Classic Stripe – Maharam |
|---------------------------------|
| Ancillary                       |
| 55" wide                        |
| 47% cotton                      |
| 27% rayon                       |
| 26% polyester                   |
| ZRS01/462170-001 Inca           |
| ZRS02/462170-002 Pistachio      |
| ZRS03/462170-003 Poppy          |
| ZRS04/462170-004 Cadet          |
| ZRS05/462170-005 Peacock        |

| Repeat Dot Ring – Maharam |
|---------------------------|
| Ancillary                 |
| 55" wide                  |
| 75% cotton                |
| 25% polyester             |
| ZRR01/462150-001 Gold     |
| ZRR04/462150-004 Pink     |
| ZRR05/462150-005 Coral    |
| ZRR07/462150-007 Gold     |
| Reverse                   |
| ZRR10/462150-010 Pink     |
| Reverse                   |
| ZRR11/462150-011 Coral    |
| Reverse                   |

| Stripes - Maharam    |
|----------------------|
| Ancillary            |
| 56" wide             |
| 92% wool             |
| 8% nylon             |
| ZSP01/463980-001 001 |
| ZSP02/463980-002 002 |
| ZSP03/463980-003 003 |
| ZSP04/463980-004 004 |
| ZSP05/463980-005 005 |
| ZSP06/463980-006 006 |
| ZSP07/463980-007 007 |
| ZSP08/463980-008 008 |
| ZSP09/463980-009 009 |
| ZSP10/463980-010 010 |

| Toostripe – Maharam                           |
|---|
| Ancillary                                     |
| 54" wide                                      |
| 92% wool                                      |
| 8% nylon                                      |
| V2201/462260-001 Orange Dark/<br>Crimson Dark |
| V2202/462260-002 Black/<br>Raw Umber          |
| V2203/462260-003 Ochre Dark/<br>Sienna        |

## Price Category M

| Fruit - Maharam                      |
|--------------------------------------|
| Seating                              |
| 54" wide                             |
| 55% cotton                           |
| 32% nylon                            |
| 13% post-consumer recycled polyester |
| PFOA-Free stain resistant finish     |
| Acrylic backing                      |
| ZF201/466262-001 Opal                |
| ZF202/466262-002 Lime                |
| ZF203/466262-003 Olive               |
| ZF204/466262-004 Sky                 |
| ZF207/466262-007 Russet              |

| Names – Maharam                          |
|--|
| Ancillary                                |
| 55" wide                                 |
| 73% cotton                               |
| 27% polyester                            |
| V1801/462510-001 Crimson On<br>White     |
| V1802/462510-002 Ultramarine<br>On White |
| V1803/462510-003 Black On<br>White       |

Price category M continued on next page

- Maharam textiles are on assigned lead times A.
- Fabric numbers are listed as Herman Miller fabric number/Maharam fabric number.

# Textile Colors

continued

Appendix: Textile Colors

## Price Category M

continued

| Ottoman Stripe – Maharam |           |
|--------------------------|-----------|
| Ancillary                |           |
| 58" wide                 |           |
| 92% wool                 |           |
| 8% nylon                 |           |
| ZQN01/466142-001         | Brass     |
| ZQN02/466142-002         | Cocoa     |
| ZQN03/466142-003         | Dusk      |
| ZQN04/466142-004         | Pistachio |
| ZQN05/466142-005         | Apricot   |

| Pressed Plaid – Maharam |     |
|-------------------------|-----|
| Ancillary               |     |
| 54" wide                |     |
| 100% wool               |     |
| T1101/466181-001        | 001 |
| T1102/466181-002        | 002 |
| T1103/466181-003        | 003 |
| T1104/466181-004        | 004 |
| T1105/466181-005        | 005 |
| T1106/466181-006        | 006 |

| Wool Striae – Maharam |     |
|-----------------------|-----|
| Ancillary             |     |
| 54" wide              |     |
| 100% wool             |     |
| T1201/466184-001      | 001 |
| T1202/466184-002      | 002 |
| T1203/466184-003      | 003 |
| T1204/466184-004      | 004 |
| T1205/466184-005      | 005 |
| T1206/466184-006      | 006 |
| T1207/466184-007      | 007 |

## Price Category N

| Alpaca Epinglé - Maharam |          |
|--------------------------|----------|
| Ancillary                |          |
| 55" wide                 |          |
| 100% alpaca              |          |
| ZAE01/465902-001         | Vellum   |
| ZAE02/465902-002         | Slate    |
| ZAE06/465902-006         | Graphite |
| ZAE07/465902-007         | Beignet  |

| Alpaca Velvet - Maharam |          |
|-------------------------|----------|
| Ancillary               |          |
| 54" wide                |          |
| 100% alpaca             |          |
| ZAV01/465901-001        | Alpine   |
| ZAV06/465901-006        | Charcoal |
| ZAV07/465901-007        | Pewter   |
| ZAV08/465901-008        | Squash   |
| ZAV09/465901-009        | Wallaby  |
| ZAV10/465901-010        | Brunia   |

| Bespoke Stripe - Maharam |           |
|--------------------------|-----------|
| Ancillary                |           |
| 56" wide                 |           |
| 100% wool                |           |
| ZBP01/463540-001         | Navy      |
| ZBP02/463540-002         | Tobacco   |
| ZBP03/463540-003         | Chocolate |
| ZBP04/463540-004         | Charcoal  |
| ZBP05/463540-005         | Black     |
| ZBP06/463540-006         | Pewter    |

| Herringbone Stripe - Maharam |          |
|------------------------------|----------|
| Ancillary                    |          |
| 57" wide                     |          |
| 100% wool                    |          |
| ZKP01/465945-001             | Granite  |
| ZKP02/465945-002             | Espresso |
| ZKP03/465945-003             | Graphite |
| ZKP04/465945-004             | Indigo   |
| ZKP05/465945-005             | Raven    |

## Price Category O

| Point – Maharam  |                       |
|------------------|-----------------------|
| Ancillary        |                       |
| 53" wide         |                       |
| 97% rayon        |                       |
| 3% nylon         |                       |
| ZPT01/466090-001 | Ivory and<br>Ember    |
| ZPT02/466090-002 | Black and<br>Coral    |
| ZPT03/466090-003 | Slate and<br>Khaki    |
| ZPT04/466090-004 | Black and<br>Cobalt   |
| ZPT05/466090-005 | Black and<br>Khaki    |
| ZPT06/466090-006 | Slate and<br>Mandarin |
| ZPT07/466090-007 | Slate and<br>Black    |
| ZPT08/466090-008 | Brick and<br>Greige   |
| ZPT09/466090-009 | Gold and<br>Black     |
| ZPT10/466090-010 | Greige and<br>Peat    |
| ZPT11/466090-011 | Peat and<br>Mandarin  |
| ZPT12/466090-012 | Crimson               |
| ZPT13/466090-013 | Mandarin              |
| ZPT14/466090-014 | Citrus                |
| ZPT15/466090-015 | Grass                 |
| ZPT16/466090-016 | Cyan                  |
| ZPT17/466090-017 | Cobalt                |

| Wool Velvet - Maharam |           |
|-----------------------|-----------|
| Ancillary             |           |
| 54" wide              |           |
| 100% wool             |           |
| ZWV01/466120-001      | Plush     |
| ZWV02/466120-002      | Subdue    |
| ZWV03/466120-003      | Flagstone |
| ZWV04/466120-004      | Nori      |
| ZWV06/466120-006      | Bridle    |
| ZWV07/466120-007      | Covert    |
| ZWV08/466120-008      | Gateway   |

## Price Category O

| Bavaria Stripe – Maharam |        |
|--------------------------|--------|
| Ancillary                |        |
| 55" wide                 |        |
| 77% polyester            |        |
| 23% cotton               |        |
| ZBS02/466161-002         | Unique |

- Maharam textiles are on assigned lead times. <sup>A</sup>
- Fabric numbers are listed as Herman Miller fabric number/Maharam fabric number.

# Textile Colors

continued

## Price Category P

| Big Stripe – Maharam |         |
|----------------------|---------|
| Ancillary            |         |
| 55" wide             |         |
| 92% wool             |         |
| 8% nylon             |         |
| ZBR01/466174-001     | Peacock |
| ZBR02/466174-002     | Spring  |
| ZBR03/466174-003     | Umber   |
| ZBR04/466174-004     | Poppy   |
| ZBR05/466174-005     | Cobalt  |

| Epinglé Stripe - Maharam |          |
|--------------------------|----------|
| Ancillary                |          |
| 50" wide                 |          |
| 100% cotton              |          |
| ZES01/466007-001         | Caramel  |
| ZES02/466007-002         | Lead     |
| ZES03/466007-003         | Violet   |
| ZES04/466007-004         | Mahogany |
| ZES05/466007-005         | Olive    |

| Layers Garden – Maharam |                     |
|-------------------------|---------------------|
| Ancillary               |                     |
| 52" wide                |                     |
| 96% wool                |                     |
| 3% nylon                |                     |
| 1% polyester            |                     |
| ZLY01/465916-001        | Ivy/Bronze          |
| ZLY02/465916-002        | Putty/<br>Turquoise |
| ZLY03/465916-003        | Pewter/<br>White    |
| ZLY04/465916-004        | Chocolate/<br>Lilac |
| ZLY05/465916-005        | Peat/Copper         |

| Layers Park – Maharam |                  |
|-----------------------|------------------|
| Ancillary             |                  |
| 52" wide              |                  |
| 95% wool              |                  |
| 3% nylon              |                  |
| 2% polyester          |                  |
| ZLP01/465918-001      | Ash/Snow         |
| ZLP02/465918-002      | Mineral/Sky      |
| ZLP03/465918-003      | Poppy/<br>Melon  |
| ZLP04/465918-004      | Indigo/<br>White |
| ZLP05/465918-005      | Earth/Cobalt     |

| Layers Vineyard Large – Maharam |                    |
|---------------------------------|--------------------|
| Ancillary                       |                    |
| 52" wide                        |                    |
| 95% wool                        |                    |
| 3% nylon                        |                    |
| 2% polyester                    |                    |
| ZLV01/465921-001                | Ivory/Onyx         |
| ZLV02/465921-002                | Slate/Azure        |
| ZLV03/465921-003                | Loden/Sky          |
| ZLV04/465921-004                | Taupe/<br>Crimson  |
| ZLV05/465921-005                | Black/<br>Mahogany |

| Layers Vineyard Small – Maharam |                    |
|---------------------------------|--------------------|
| Ancillary                       |                    |
| 52" wide                        |                    |
| 92% wool                        |                    |
| 5% polyester                    |                    |
| 3% nylon                        |                    |
| ZLS01/465920-001                | Ochre/White        |
| ZLS02/465920-002                | Scarlet/<br>Peony  |
| ZLS03/465920-003                | Taupe/Violet       |
| ZLS04/465920-004                | Jade/<br>Turquoise |
| ZLS05/465920-005                | Ginger/Rose        |

| Mohair Supreme - Maharam |                     |
|--------------------------|---------------------|
| Ancillary                |                     |
| 54" wide                 |                     |
| 100% mohair              |                     |
| ZMS02/451801-072         | Stonehenge          |
| ZMS06/451801-112         | Slate *             |
| ZMS07/451801-113         | Rich<br>Chocolate * |
| ZMS09/451801-126         | Cayenne             |
| ZMS10/451801-127         | Cognac              |
| ZMS12/451801-129         | Peat *              |
| ZMS15/451801-133         | Abyss               |
| ZMS16/451801-134         | Intrigue            |
| ZMS18/451801-136         | Lupine *            |
| ZMS28/451801-146         | League              |
| ZMS29/451801-147         | Armory *            |
| ZMS32/451801-150         | Capiz               |
| ZMS33/451801-151         | Underneath          |
| ZMS34/451801-152         | Crescent            |
| ZMS35/451801-153         | National            |
| ZMS36/451801-154         | Rooftop             |
| ZMS37/451801-155         | Skewer              |
| ZMS38/451801-156         | Party               |
| ZMS39/451801-157         | Keepsake            |
| ZMS40/451801-158         | Travel              |
| ZMS41/451801-159         | Estate              |
| ZMS42/451801-160         | Grassland           |
| ZMS43/451801-161         | Limoncello          |
| ZMS44/451801-162         | Mango               |
| ZMS45/451801-163         | Doll                |
| ZMS46/451801-164         | Carousel            |
| ZMS47/451801-165         | Palette             |
| ZMS48/451801-166         | Brandy              |
| ZMS49/451801-167         | Aristocrat          |
| ZMS50/451801-168         | Soulmate            |
| ZMS51/451801-169         | Rosette             |
| ZMS52/451801-170         | Aviator             |
| ZMS53/451801-171         | Penny               |

\* Colors available on Eames Lounge Chair and Ottoman.

## Price Category Q

| A Band Apart – Maharam |        |
|------------------------|--------|
| Ancillary              |        |
| 56" wide               |        |
| 75% polyester          |        |
| 25% cotton             |        |
| ZAB01/466000-001       | Unique |

| Brushed Camel – Maharam |         |
|-------------------------|---------|
| Ancillary               |         |
| 58" wide                |         |
| 100% baby camel hair    |         |
| ZBA01/465977-001        | Albino  |
| ZBA02/465977-002        | Natural |

| Deconstructed Rose – Maharam |         |
|------------------------------|---------|
| Ancillary                    |         |
| 55" wide                     |         |
| 65% polyester                |         |
| 32% cotton                   |         |
| 3% rayon                     |         |
| ZDS01/466086-001             | Golden  |
| ZDS02/466086-002             | Vivid   |
| ZDS03/466086-003             | Earthen |

| Massive Paisley – Maharam |          |
|---------------------------|----------|
| Ancillary                 |          |
| 57" wide                  |          |
| 76% polyester             |          |
| 24% cotton                |          |
| ZMV01/465915-001          | Ash      |
| ZMV03/465915-003          | Cardinal |
| ZMV06/465915-006          | Night    |

| The Firm – Maharam |        |
|--------------------|--------|
| Ancillary          |        |
| 56" wide           |        |
| 75% polyester      |        |
| 25% cotton         |        |
| ZTF03/465999-003   | Unique |

- Maharam textiles are on assigned lead times. A
- Fabric numbers are listed as Herman Miller fabric number/Maharam fabric number.

# Textile Colors

continued

Appendix: Textile Colors

## Price Category R

| Borders – Maharam         |  |
|---------------------------|--|
| Ancillary                 |  |
| 53" wide                  |  |
| 98% wool                  |  |
| 2% polyester              |  |
| ZBB01/466082-001 Natural  |  |
| ZBB02/466082-002 Greige   |  |
| ZBB03/466082-003 Charcoal |  |
| ZBB04/466082-004 Walnut   |  |

| Stow Leather - Maharam      |  |
|-----------------------------|--|
| Ancillary                   |  |
| approx. 50 sq. ft. per hide |  |
| 100% leather                |  |
| protective top coat         |  |
| ZSV01/700014-001 Opera      |  |
| ZSV02/700014-002 Japonica   |  |
| ZSV03/700014-003 Masquerade |  |
| ZSV04/700014-004 Laguna     |  |
| ZSV05/700014-005 Jettison   |  |
| ZSV06/700014-006 Razor      |  |
| ZSV07/700014-007 Holiday    |  |
| ZSV08/700014-008 Patchouli  |  |
| ZSV09/700014-009 Macrame    |  |
| ZSV10/700014-010 Grace      |  |
| ZSV11/700014-011 Seraphim   |  |
| ZSV12/700014-012 Ricotta    |  |
| ZSV13/700014-013 Neroli     |  |
| ZSV14/700014-014 Sultana    |  |
| ZSV15/700014-015 Sundance   |  |
| ZSV16/700014-016 Quince     |  |
| ZSV17/700014-017 Babka      |  |
| ZSV18/700014-018 Maitake    |  |
| ZSV19/700014-019 Mercer     |  |
| ZSV20/700014-020 Gaucho     |  |
| ZSV21/700014-021 Chia       |  |
| ZSV22/700014-022 Vanguard   |  |
| ZSV23/700014-023 Zone       |  |
| ZSV24/700014-024 Zeppelin   |  |

| Stow Leather <i>continued</i> |  |
|-------------------------------|--|
| ZSV25/700014-025 Clandestine  |  |
| ZSV26/700014-026 Raven        |  |
| ZSV27/700014-027 Cabana       |  |
| ZSV28/700014-028 Rime         |  |
| ZSV29/700014-029 Forsythia    |  |
| ZSV30/700014-030 Panthera     |  |
| ZSV31/700014-031 Dune         |  |
| ZSV32/700014-032 Madera       |  |
| ZSV33/700014-033 Russet       |  |
| ZSV34/700014-034 Gala         |  |
| ZSV35/700014-035 Heron        |  |

## Price Category S

| Bavaria – Maharam       |  |
|-------------------------|--|
| Ancillary               |  |
| 55" wide                |  |
| 73% polyester           |  |
| 27% cotton              |  |
| ZBV01/466162-001 Unique |  |

## Price Category T

| All Grain Leather – Edelman         |              |
|-------------------------------------|--------------|
| Ancillary                           |              |
| approx. 50 sq. ft. per hide         |              |
| 100% full-grain Aniline-dye cowhide |              |
| VB01/AG01                           | Pitch Brown  |
| VB02/AG02                           | White        |
| VB03/AG03                           | Cloud        |
| VB04/AG04                           | Shadow       |
| VB05/AG05                           | Black        |
| VB06/AG06                           | Baked Bean   |
| VB07/AG07                           | Mildew       |
| VB08/AG08                           | Soot         |
| VB09/AG09                           | Blue Jeans   |
| VB10/AG10                           | Merlot       |
| VB11/AG11                           | Nutmeg       |
| VB12/AG12                           | Butter       |
| VB13/AG13                           | Cherry       |
| VB14/AG14                           | Burnt Orange |
| VB15/AG15                           | Whiskey      |
| VB17/AG17                           | Raw Silk     |
| VB18/AG18                           | Balsa        |
| VB19/AG19                           | Naturale     |
| VB21/AG21                           | Greige       |
| VB22/AG27                           | Latte        |
| VB23/AG28                           | Coral        |
| VB24/AG29                           | Rose         |
| VB25/AG30                           | Zinnia       |
| VB26/AG31                           | Iris         |
| VB27/AG32                           | Daffodil     |

| Hours – Maharam  |       |
|------------------|-------|
| Ancillary        |       |
| 56" wide         |       |
| 95% wool         |       |
| 3% nylon         |       |
| 2% rayon         |       |
| ZKR01/466092-001 | Day   |
| ZKR02/466092-002 | Night |

- Maharam textiles are on assigned lead times. <sup>A</sup>
- Fabric numbers are listed as Herman Miller fabric number/Maharam fabric number.



# Textile Colors

continued

| Price Category U   | Price Category V-W                        | Price Category X  | Price Category Y  |
|--|---|---|---|
| <p><b>Layers Garden Double – Maharam</b></p> <p>Ancillary<br/>52” wide<br/>96% wool<br/>3% nylon<br/>1% polyester</p> <p>ZLD01/465917-001 Ash/<br/>Quartz/<br/>Grass</p> <p>ZLD02/465917-002 Earth/<br/>Chocolate/<br/>Coral</p> <p>ZLD03/465917-003 Black/<br/>Navy/<br/>Cobalt</p> | <p>No fabrics available at this time.</p> | <p><b>Eden – Maharam</b></p> <p>Ancillary<br/>56” wide<br/>83% polyester<br/>17% cotton</p> <p>ZED01/466258-001 001</p> <p>ZED02/466258-002 002</p> <p>ZED03/466258-003 003</p> <p>ZED04/466258-004 004</p> <p>ZED05/466258-005 005</p> | <p><b>Industry – Maharam</b></p> <p>Ancillary<br/>55” wide<br/>80% polyester<br/>20% cotton</p> <p>ZND01/466255-001 001</p> |
| <p><b>Layers Park Double – Maharam</b></p> <p>Ancillary<br/>52” wide<br/>96% wool<br/>3% nylon<br/>1% polyester</p> <p>ZLB01/465919-001 Mineral/<br/>Taupe/<br/>Lemon</p> <p>ZLB02/465919-002 Sienna/<br/>Ginger/<br/>Rose</p> <p>ZLB03/465919-003 Black/<br/>Peat/<br/>Copper</p>   |   | <p><b>Foliage – Maharam</b></p> <p>Ancillary<br/>56” wide<br/>75% polyester<br/>25% cotton</p> <p>ZFG02/466257-002 002</p> <p>ZFG04/466257-004 004</p> <p>ZFG05/466257-005 005</p>  |   |

Appendix: Textile Colors

- Maharam textiles are on assigned lead times. A
- Fabric numbers are listed as Herman Miller fabric number/Maharam fabric number.

# Textile Colors

continued

## Price Category Z

| Agency – Maharam |     |
|------------------|-----|
| Ancillary        |     |
| 55" wide         |     |
| 75% polyester    |     |
| 25% cotton       |     |
| ZAG02/466001-002 | 002 |
| ZAG04/466001-004 | 004 |
| ZAG05/466001-005 | 005 |
| ZAG06/466001-006 | 006 |
| ZAG07/466001-007 | 007 |
| ZAG08/466001-008 | 008 |

## Price Category 10M

| Pace Leather – Maharam      |            |
|-----------------------------|------------|
| Ancillary                   |            |
| approx. 50 sq. ft. per hide |            |
| 100% leather                |            |
| ZPA01/700011-001            | Whisper    |
| ZPA02/700011-002            | Shy        |
| ZPA03/700011-003            | Granite    |
| ZPA04/700011-004            | Misty      |
| ZPA05/700011-005            | Studio     |
| ZPA06/700011-006            | Throne     |
| ZPA07/700011-007            | Proper     |
| ZPA08/700011-008            | Huron      |
| ZPA09/700011-009            | Darkroom   |
| ZPA10/700011-010            | Bark       |
| ZPA11/700011-011            | Raspberry  |
| ZPA12/700011-012            | Sangria    |
| ZPA13/700011-013            | Admiral    |
| ZPA14/700011-014            | Juniper    |
| ZPA15/700011-015            | Regal      |
| ZPA16/700011-016            | Vapor      |
| ZPA17/700011-017            | Valley     |
| ZPA18/700011-018            | Bushel     |
| ZPA19/700011-019            | Heirloom   |
| ZPA20/700011-020            | Palomino   |
| ZPA21/700011-021            | Bamboo     |
| ZPA22/700011-022            | Saffron    |
| ZPA23/700011-023            | Tearose    |
| ZPA24/700011-024            | Canyon     |
| ZPA25/700011-025            | Bistro     |
| ZPA26/700011-026            | Toffee     |
| ZPA27/700011-027            | Rodeo      |
| ZPA28/700011-028            | Mudslide   |
| ZPA29/700011-029            | Greige     |
| ZPA30/700011-030            | Reflection |
| ZPA31/700011-031            | Pure       |
| ZPA32/700011-032            | Desert     |
| ZPA33/700011-033            | Griffin    |
| ZPA34/700011-034            | Urbane     |
| ZPA35/700011-035            | Woodrose   |

Appendix: Textile Colors

- Maharam textiles are on assigned lead times. <sup>A</sup>
- Fabric numbers are listed as Herman Miller fabric number/Maharam fabric number.



For more information about our products and services or to see a list of dealers, please visit us at [HermanMiller.com](http://HermanMiller.com) or call (800) 851 1196.

© 2025 Herman Miller, Inc., Zeeland, Michigan

#### Distribution Rights

Working together since 1956, Herman Miller and Vitra are the authentic sources of designs by Charles and Ray Eames, Alexander Girard, and George Nelson. All the designs shown in this book are protected by law. Herman Miller has obtained all rights to make and sell these designs. Also, Herman Miller holds exclusive worldwide manufacturing and distribution rights for these products with the following exceptions:

Charles and Ray Eames, George Nelson, and Alexander Girard—Worldwide distribution rights for furniture in all areas except Europe and the Middle East. For those areas, please contact Vitra.

Isamu Noguchi—Worldwide distribution rights for the Noguchi Rudder Table. Distribution rights for the Noguchi Table in North America and Central America only. For all other areas, please contact Vitra.

Magis—Exclusive distribution rights in the US and Canada. For all other areas, please contact Magis.

© HermanMiller, 3D Intelligent, 8Z Pellicle, AO, Action Office, Aeron, Aside, Bubble Lamps, Canvas Office Landscape, Caper, Celle, Cosm, Co/Struc, Daisyone, Distil, Eames, Eco-Dematerialized, Embody, Envelop, Ethospace, Exclave, Fine-Tune, FlexFront, Flo, Formcoat, Formwork, Ground Cloth, Intent, Kinemat, Layout Studio, Lino, Live Unframed, Living Office, Maharam, Meridian, Mirra, Motia, Nelson, Pari, Pellicle, Perspectives, Plex, PostureFit, PostureFit SL, Public Office Landscape, Sayl, Setu, Striad, Tu, Ubi, Verus, Wishbone, Y-Tower and Zeph are among the registered trademarks of Herman Miller, Inc., and its owned subsidiaries.

™ About Face, AireWeave, Airia, Ambit, Asari Chair by HermanMiller, Backfit, Bubbletack, Burdick Group, Butterfly Back, Canvas Vista, Cellular Suspension, Commend, Compass, Connect, DOT, Duracare, Durawrap, EnhancedAccess, Everywhere, Flex-Edge, Flute, Harmonic, Headway, Herman Miller Select, Hopsak 2, Iota, Keyless Entry, Latitude, Logic Mini, Logic Power Access Solutions, Lyris, Lyris 2, Made-to-Measure Storage, Mora, Multiscrim, Nevi, OE1, OE1 Workspace Collection, Overlay, Pixelated Support, Pronta, Renew, Sense, Soft Pad, Stackable, Stackable Storage, Swoop, Thrive, Tone, TriFlex, Twist and Wireframe are among the trademarks of Herman Miller, Inc., and its owned subsidiaries.

SM Herman Miller Options is among the service marks of Herman Miller, Inc.

AAP™ is a trademark of Extron Electronics.

Alexander Girard® is a registered trademark of The Alexander Girard Estate.

Chemisur® is a registered trademark of Wilsonart International.

Corian® is a registered trademark of E. I. du Pont de Nemours and Company Corporation.

Crypton® is a registered trademark of Crypton, Inc.

DACRON® is a registered trademark of INVISTA S.a r.l.

Danzer® is a registered trademark of Danzer Holding AG.

Decora® is a registered trademark of Leviton Manufacturing Co., Inc.

Edelman® Leather is a registered trademark of Edelman Leather, Inc.

Extron® is a registered trademark of RGB Systems, Inc.

FENIX NTM® is a registered trademark of Arpa Industriale S.p.A.

FLEXNET™ is a trademark of Milliken & Company.

Floor Saver Glide® is a registered trademark of Carpin Manufacturing, Inc.

Forest Stewardship Council® is a registered trademark of the Forest Stewardship Council A.C. (FSC). We are FSC® certified (FSC® C102895).

FSC® is a registered trademark of the Forest Stewardship Council A.C. (FSC).

Geiger® is a registered trademark, and Bumper™, Saiba™, and Ward Bennett™ are trademarks, of Geiger International.

Hang-It-All® is a registered trademark of Lucia Eames Demetrios, d.b.a. Eames Office.

Holophane® is a registered trademark of Holophane.

Ingeo™ is a trademark of Cargill Dow LLC.

iPad® and Mac mini® are registered trademarks of Apple Inc.

Leviton® is a registered trademark of Leviton Manufacturing Co., Inc.

LifeSize® is a registered trademark of LifeSize Communications, Inc.

Lisocore® is a registered trademark of Pyrus Panels GmbH.

Logitech G® is a registered trademark of Logitech International S.A.

Magis®, Bombo®, and Me Too® are registered trademarks of Magis S.p.A.

MicrobeCare™ is a trademark of Parasol Medical LLC.

Microsoft® and Natural® Keyboard are registered trademarks of Microsoft Corporation.

Noguchi® and the Noguchi table configuration (trade dress) are registered trademarks, and Rudder Table™ is a trademark, of The Isamu Noguchi Foundation and Garden Museum.

Place Textiles® is a registered trademark of Place Textiles.

Sunbrella® is a registered trademark of Glen Raven, Inc.

SuperSeat™ is a trademark of Dahti Seating, a division of ITW.

Valor™ is among the trademarks owned by Nemschoff, Inc.