

PLAN VIEW

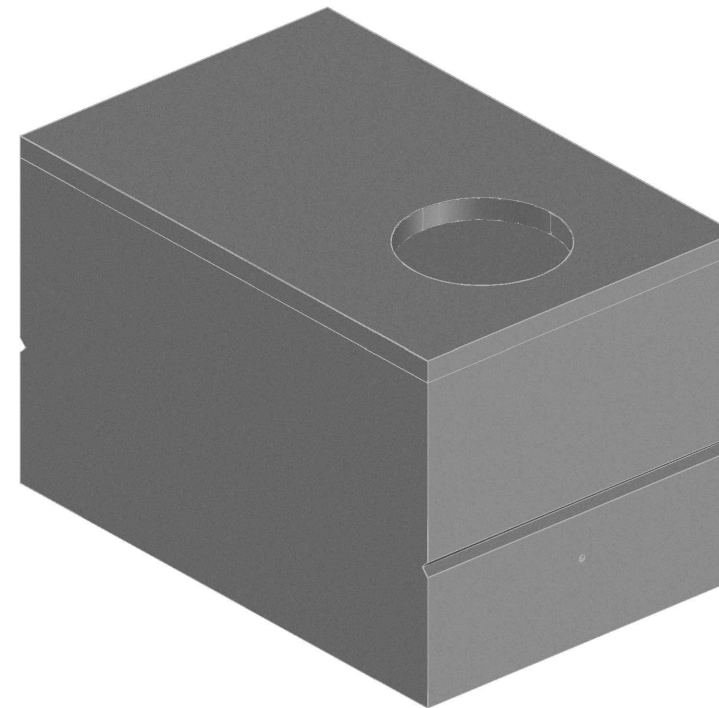

ISOMETRIC

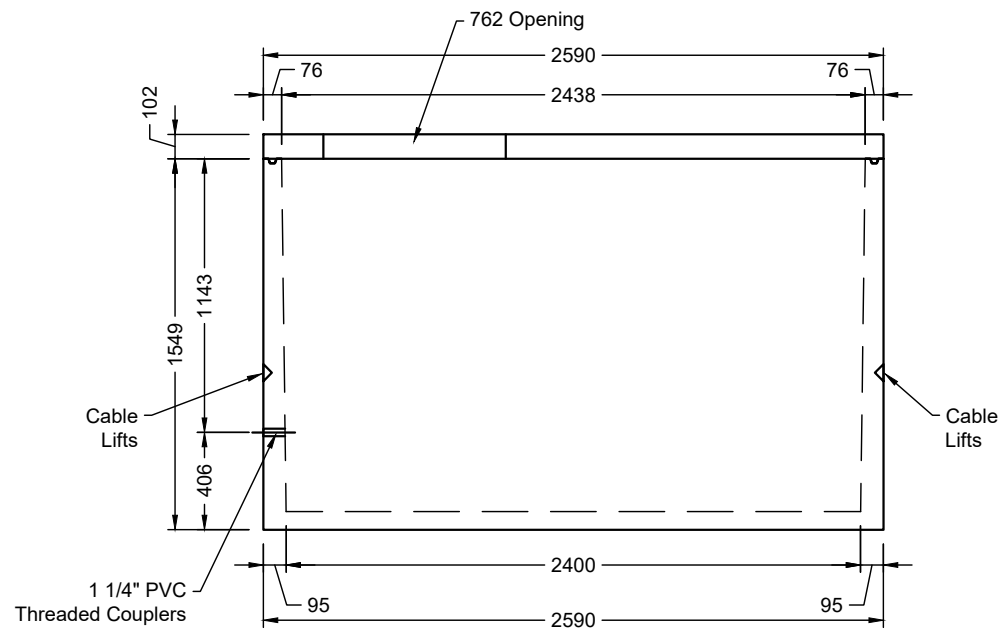

SECTION A-A

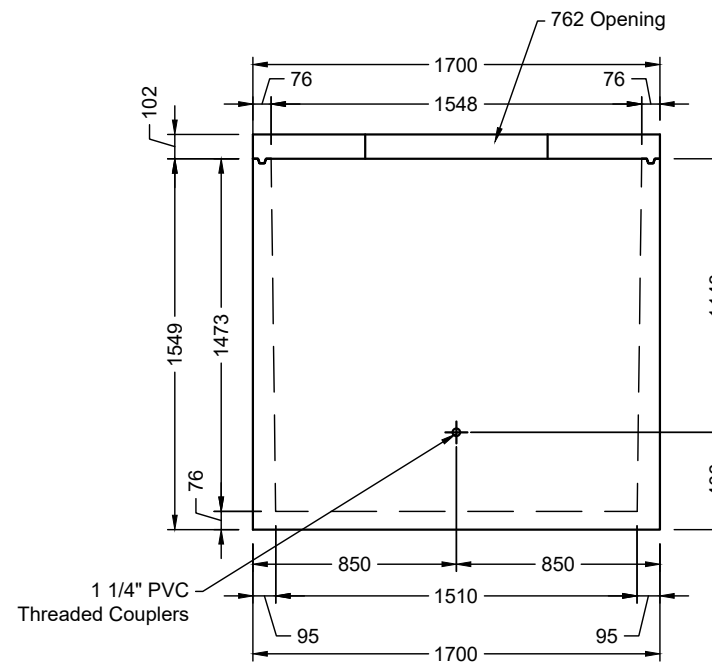

SECTION B-B

CONCRETE	RELEASE	MPa	20
	28 DAY:	MPa	35
	AIR CONTENT:		6% ± 1%
	WEIGHT: kg	4600	VOLUME m ³
	TYPE:	kg/m ³	2402
STRAND		mm	-
		MPa	-
MARK	DESCRIPTION	QTY.	



- NOTES:
- 1) CEMENT : PORTLAND CEMENT TYPE 50(HS)
 - 2) Max AGGREGATE SIZE: 20mm
 - 3) 28 DAY STRENGTH: MIN. 35 MPa.
 - 4) ENTRAINED AIR: 6%±1%
 - 5) REINFORCING TO CAN/CSA-G30.18 400 MPa
 - 6) ALL UNITS ARE IN MILLIMETERS UNLESS OTHERWISE NOTED.

DWG. NO.	REFERENCE	NO.:	REVISION DESCRIPTION	BY	APP'D	DATE	DRW BY	SWM	2018/11/16
-	-	A	ISSUED PLAN	-	-	2018/11/16	CH'K BY	-	-
-	-	-	-	-	-	-	AP'D BY	-	-
-	-	-	-	-	-	-	AP'D BY	-	-
-	-	-	-	-	-	-	SCALE: NTS	PAGE: 1 OF 1	

TITLE:	1250 Gallon Water Cistern DETAIL DRAWING	
PROJECT NO.:		JOB NO.:
DRAWING NO.:	SVI-WC-1250-01A	