

# PRODUCT DATA SHEET

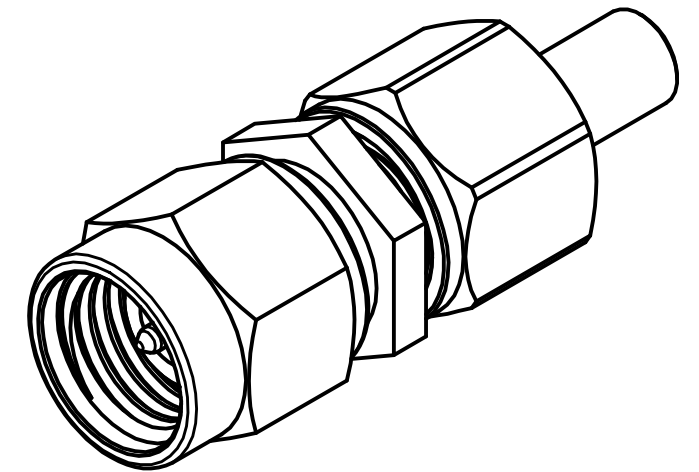
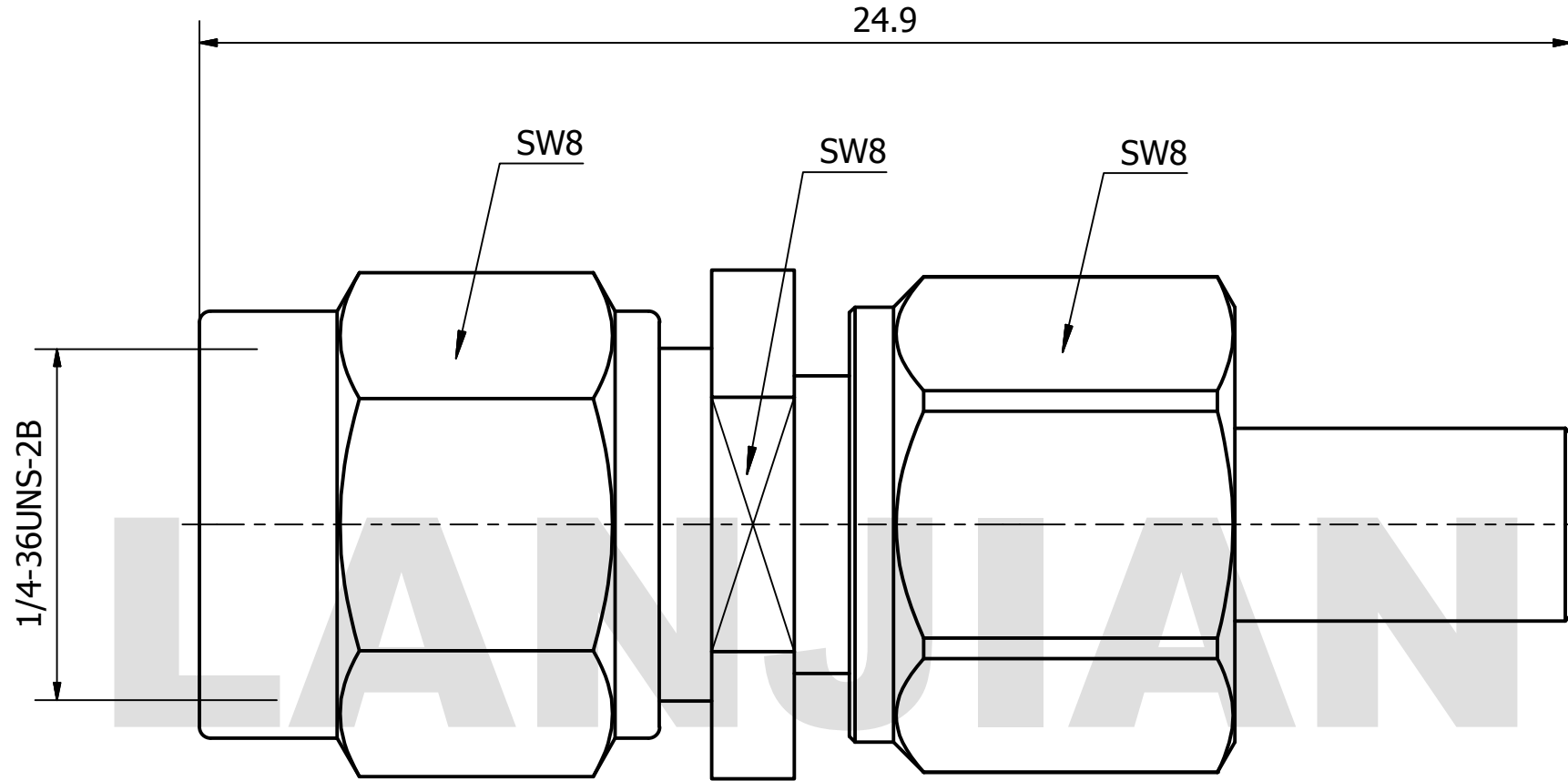

**MATERIAL:**  
 BODY: STAINLESS STEEL PER AMS-5640,  
 ALLOY UNS S30300  
 CONTACT: BERYLLIUM COPPER PER ASTM B196.  
 ALLOY NO. UNS C17300  
 INSULATOR: PEI

**PERFORMANCE:**  
 IMPEDANCE: 50 OHMS  
 FREQUENCY: DC TO 40GHz  
 VSWR:  $\leq 1.35$

THIS DOCUMENT CONTAINS CONFIDENTIAL AND PROPRIETARY INFORMATION THAT CANNOT BE REPRODUCED OR DIVULGED, IN WHOLE OR IN PART, WITHOUT WRITTEN AUTHORIZATION FROM "LANJIAN ELECTRONICS"	MATERIAL :			 38 Hengtong Road, Xinqu Dingmao Zhenjiang, 212009, Jiangsu, P. R. China	
	UNLESS OTHERWISE SPECIFIED: DIMENSIONS IN MM				
	TOLERANCES :				
	X.X	$\pm 0.20$	ANGULAR : $\pm 1^\circ$		DEBURR AND BREAK SHARP EDGES
	X.XX	$\pm 0.10$	FILLETS R/C : $\pm 0.10$		
	X.XXX	$\pm 0.01$	SURFACE FINISH : Ra 1.6		
		NAME	DATE	SIGNATURE	
	DRAWN				
	CHK'D				
	APPV'D				
MFG					
PROJECTION		SIZE	SCALE	DWG No.	REV.
		A3	8 : 1	GCPZ3.650.C.010	
DO NOT SCALE THE DRAWING				PAGE	1 / 1