

IMPORTANT — 1957 CATALOG OF ARCHERY EQUIPMENT WATER SKIS AND ACCESSORIES



THE HOME OF BLACK HAWK® ARCHERY EQUIPMENT

Manufactured by . . .

CRAVOTTA BROTHERS, INC.

THIRD STREET, EAST McKEESPORT, PA.

DISCOUNT
40%

Even the Ladies Can Hunt with Bow and Arrow



Distributed by

ARCHERY SALES & SERVICE CO.

617 South State Street
CHICAGO 5, ILLINOIS

CATALOG 5

TO OUR CUSTOMERS, THE SPORTING GOODS DEALER AND JOBBER:

We firmly believe that the Sporting Goods Dealer of the United States serves the most discriminating clientel in the world, and with this belief in mind, we have strived and are striving to supply you with a complete line of the finest archery tackle that can possibly be produced and assembled for distribution anywhere.

Our bows have a history of many years of research and design by some of the best known technicians of our times. They have not been manufactured merely as another item to be produced and sold, but are the fruits of the skill of these technicians; the careful design to achieve the ultimate; the rigid specifications of tested prime materials combined with the skill of the bower's art to achieve a bow that will give the ultimate in cast and in smoothness, in speed and in impact, a bow that is truly a jewel among bows. We are proud of the results, and grateful to the sportsmen for their ever increasing demand for Black Hawk products — a demand that has indeed forced us to expand our production facilities many times in the past years, in order that we can better serve these demands.

We have found through exhaustive research, that a bow properly designed and properly balanced must, in order to achieve perfection, be produced by a combination of materials that, fortunately for the archers sake, have been made available in the last few years by the rapid technological advances in the field of laminates and resins, and skillful design and craftsmanship. We use only the highest quality of selected hardwoods, high elevation maple, osage, walnuts and other semi-precious woods in our bows, carefully cut and tapered in our own shops, under skillful supervision, combined with carefully made and selected glass backing and facing, and welded with the finest resins available.

In the following pages, you will find listed and pictured the finest equipment available for your display and sales to your customers, carefully manufactured Black Hawk equipment, that has undergone the rigid tests that our bows have, each item a gem in its own field—Black Hawk Arrows, Black Hawk Accessories, Black Hawk Aluminum (that has swept the country), Targets, Nocks and Points, Black Hawk Strings, and many other items manufactured by us, also the finest leather goods available, combined with accessories, in short a complete line of archery equipment that will eliminate all your headaches. You can fully stock your shop from one source, with the gratifying knowledge that you have the best for your customers, and best for yourself.

CRAVOTTA BROTHERS, INC.



"Archery is the King of Sports."

"Every Archer Hunter is a True Conservationist."

NOTICE—On any drop shipments made from the factory there will be a service charge of \$2.50 per shipment.

NOTICE—Any shipment with a list price of less than \$20.00 there will be a service charge of \$2.50.

NOTICE—All prices in this book are based on existing tax conditions. Should additional federal and (or) state taxes be levied such taxes will be added to all invoices.

All prices are F.O.B. East McKeesport, Pa.

On orders, net cost from \$500 to \$1,000 we allow 50% Freight

On orders of \$1,000 or more net, we allow Full Freight.

All freight shipments are shipped Collect.

Freight Rate will be based on lowest cost transportation, which is normally motor freight.

If customer requests other methods of shipment, we reserve the right to make allowance.

All C.O.D. Orders — 25% Deposit Required

Any orders on open account must be accompanied by references or a good credit rating with Dunn & Bradstreet or the Credit Bureau.

Please allow us time to check your Credit Rating.

Any merchandise returned must be returned within five days, Postpaid by Customer.

Unless damaged or defective material returned, there will be a 10% charge for re-inventorying.

Prices subject to change without notice.

We reserve the right to change specifications of any merchandise listed in this catalog without notice to the customer.

BLACK HAWK® BOWS THE BLACK HAWK® WARRIOR

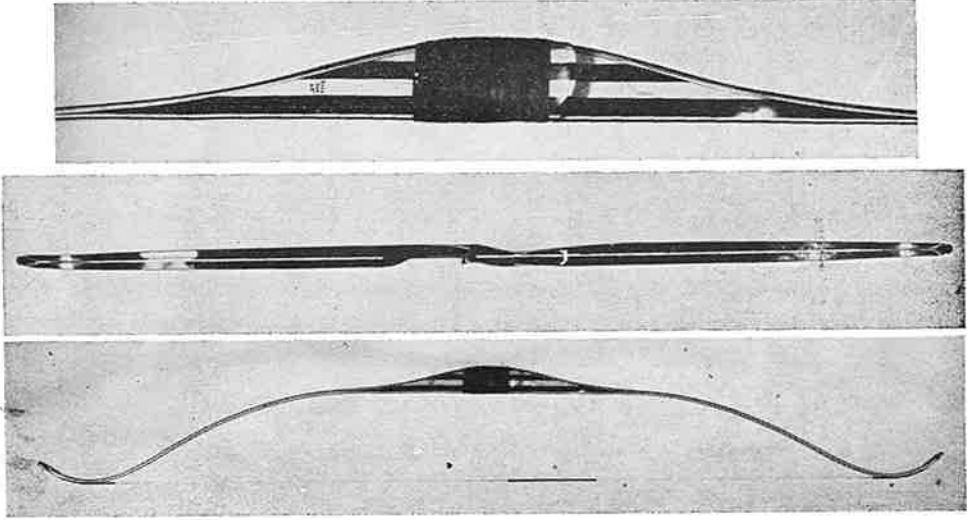

BLACK HAWK® WARRIOR is guaranteed for one year and is constructed of the same materials as the Chief; has an offset forward type handle or riser. It is an ideal bow for target, field or hunting, and will accommodate arrows up to 28"; the length of bow is 5'1", and weights from 30 to 65 pounds at 28" draw.

The Black Hawk Warrior—BHW52 List Price \$52.00
 Any Bow Ordered Over 65#—Add \$1.00 per Pound to List Price.
 Left Hand Bows Made To Order—Allow 60 Days for Delivery.

THE BLACK HAWK® WASP

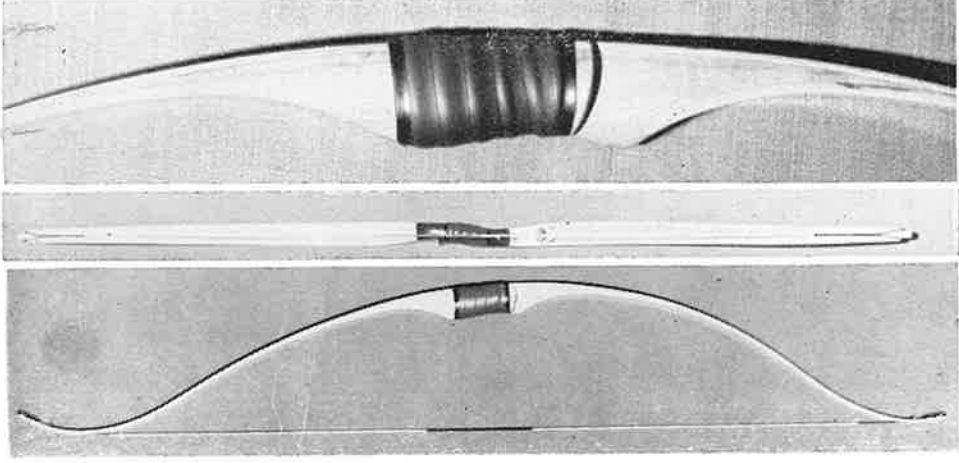

This bow is guaranteed for one year. Bows are available in two lengths: 62" and 58 1/2" unbraced; braced, the lengths are, respectively, 4'11" and 4'7". Bows are made in weights from 25 lb. to 65 lb. at 28" draws.

The Black Hawk Wasp—BHW48, either length List Price \$48.00
 Any Bow Ordered Over 65#—Add \$1.00 per Pound to List Price.
 Left Hand Bows Made To Order—Allow 60 Days for Delivery.

NOTICE — WHEREVER POSSIBLE, ORDER BY STOCK NUMBER.

BLACK HAWK® BOWS THE BLACK HAWK® CHIEF

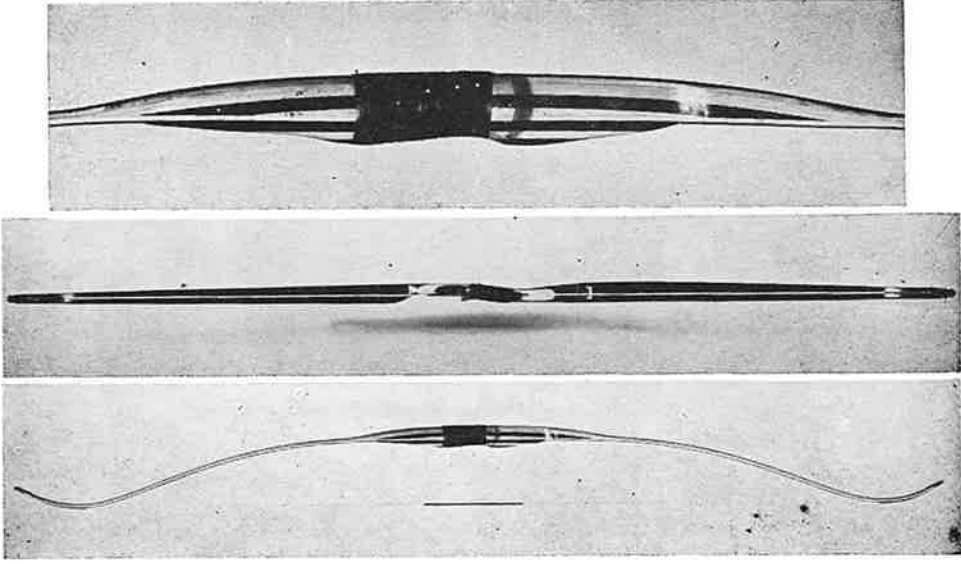

THE BLACK HAWK CHIEF BOW is designed primarily for target shooting; it is also excellent for field and hunting. The speed and trajectory is amazing; the material and workmanship are of the finest. The composition of this bow consists of glass backing and facing, maple cores and two-tone handles or risers made of maple and walnut wrapped with a beautiful leather grip. The bow is guaranteed for one year. The bows come in one length 5'8" and weights from 30 to 60 pounds at 28" draw.

The Black Hawk Chief—BHC65 List Price \$65.00
 Any Bow Ordered Over 60#—Add \$1.00 per Pound to List Price.
 Left Hand Bows Made To Order—Allow 60 Days for Delivery.

THE BLACK HAWK® HORNET

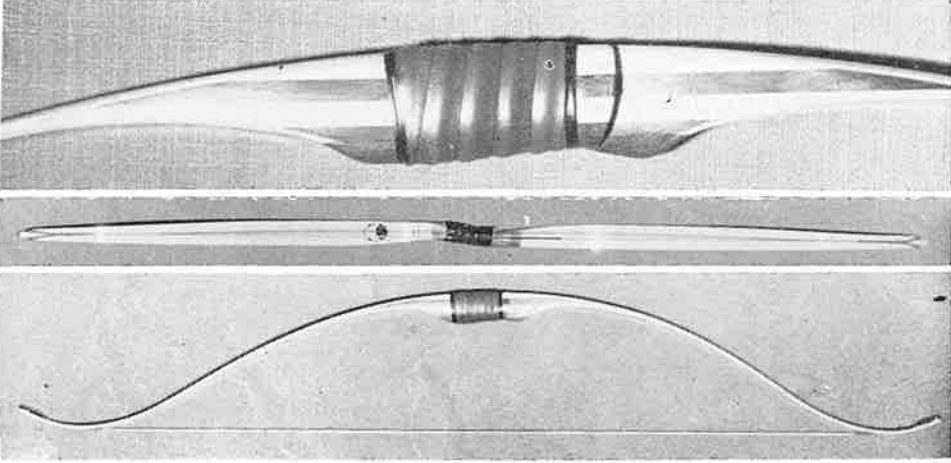

This bow is guaranteed for one year. Bows are available in two lengths: 62" and 58 1/2" unbraced; braced, the lengths are, respectively, 4'11" and 4'7". Bows are made in weights from 30 lb. to 70 lb. at 28" draws.

The Black Hawk Hornet—BHH56, either length List Price \$56.00
 Any Bow Ordered Over 70#—Add \$1.00 per Pound to List Price.
 Left Hand Bows Made To Order—Allow 60 Days for Delivery.

NOTICE — WHEREVER POSSIBLE, ORDER BY STOCK NUMBER.

BLACK HAWK® BOWS

THE BLACK HAWK® BEE

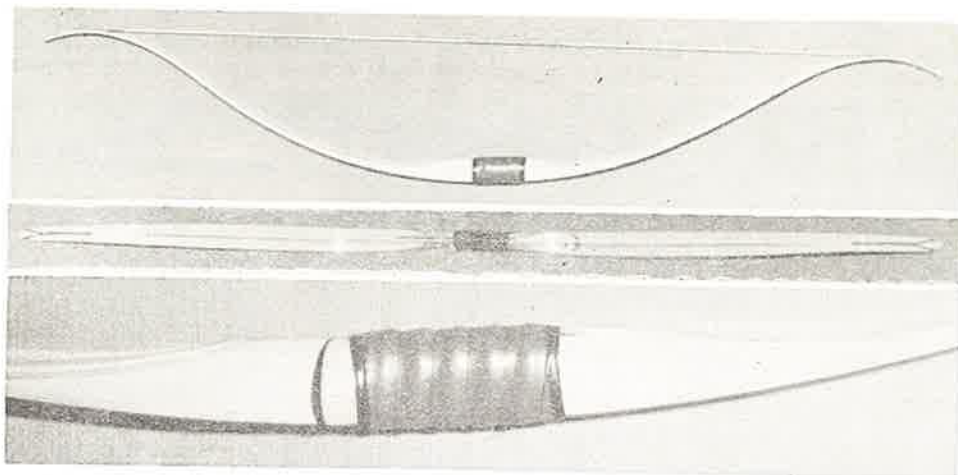

This bow is guaranteed for one year. Bows are available in two lengths: 62" and 58½" unbraced; braced, the lengths are, respectively, 4'11" and 4'7". Bows are made in weights from 25 lb. to 60 lb. at 28" draws.

The Black Hawk Bee—BHB36, either length List Price **\$36.00**

Any Bow Ordered Over 60#—Add \$1.00 per Pound to List Price.

Left Hand Bows Made To Order—Allow 60 Days for Delivery.

THE BLACK HAWK® YELLOW JACKET

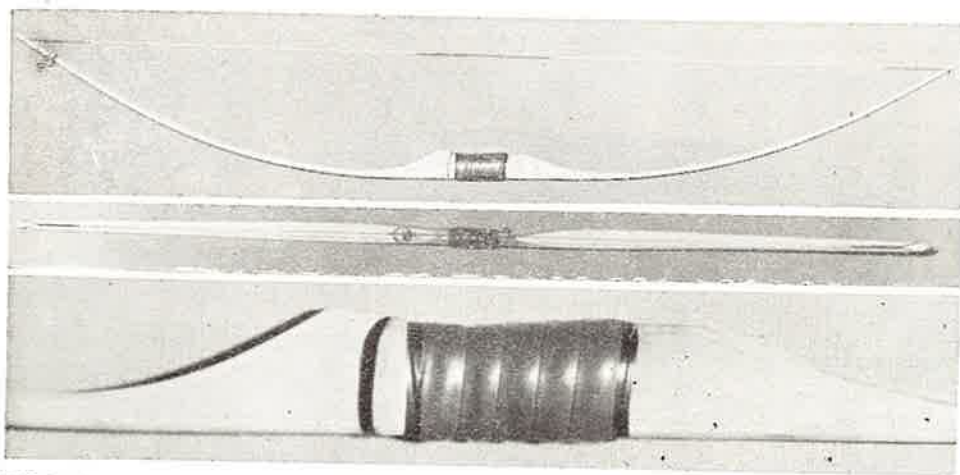

THE BLACK HAWK YELLOW JACKET BOW is a straight limb bow, designed for target, field and hunting; is very rugged and fast. It consists of glass backing, hickory, maple and composition facing. The length of bow is 5'6" and bow weights are from 30 to 60 pounds at 28" draw.

THE Black Hawk Yellow Jacket—BHYJ24 List Price **\$23.95**

Any Bow Ordered Over 60#—Add \$1.00 per Pound to List Price.

Left Hand Bows Made To Order—Allow 60 Days for Delivery.

BLACK HAWK® BOWS

THE BLACK HAWK® SCORPION

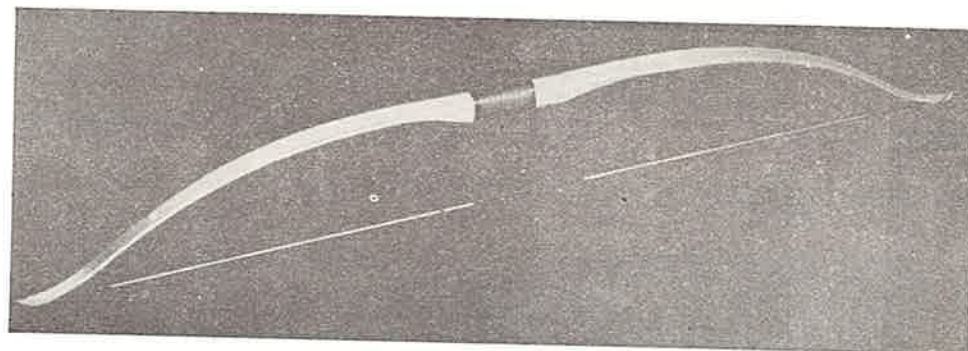
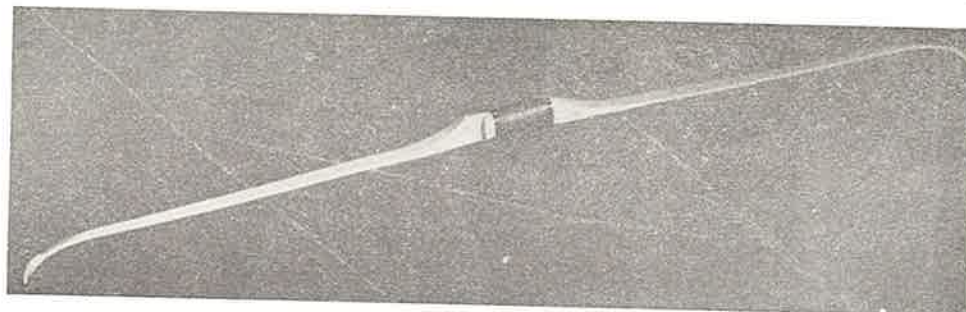

The Black Hawk® Scorpion is a bow designed for the ladies and the youngsters who do not draw over 26". The backing consists of fiberglass, and the rest of the bow is made of the finest materials used in the making of composite bows. The bow nocks are made of nylon and the string is of dacron. The weights of this bow range from 15 to 40 lbs.; the length of the bow unbraced, is 58" from tip to tip.

The Black Hawk Scorpion—BHS19 List Price **\$18.95**

Any Bow Ordered Over 40#—Add \$1.00 per Pound to List Price.

Left Hand Bows Made To Order—Allow 60 Days for Delivery.

BLACK HAWK® BOWS

THE BLACK HAWK® MOSQUITO

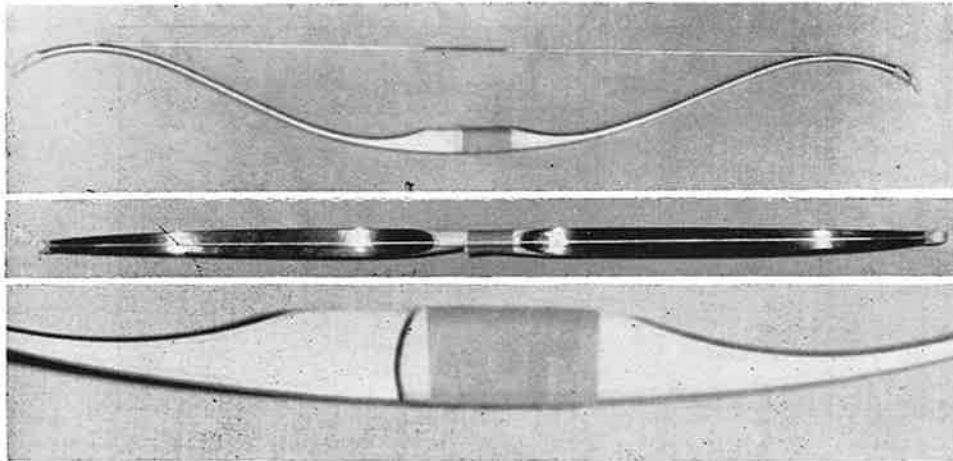

THE BLACK HAWK MOSQUITO is a bow designed for the youngster who wants a bow that looks and shoots like Daddy's bow. As far as we know, we believe that this is the only kid's working recurve bow being made commercially to sell at this amazing, low price. The bow consisting of backing, hickory, maple and composition facing, nylon bow nocks, and dacron string, weighs from 15 to 35 pounds at 25" draw. Bow comes packaged two to the carton.

The Black Hawk Mosquito—BHM11 List Price **\$10.95**

Left Hand Bows Made To Order—Allow 60 Days for Delivery.

THE BLACK HAWK® FLEA

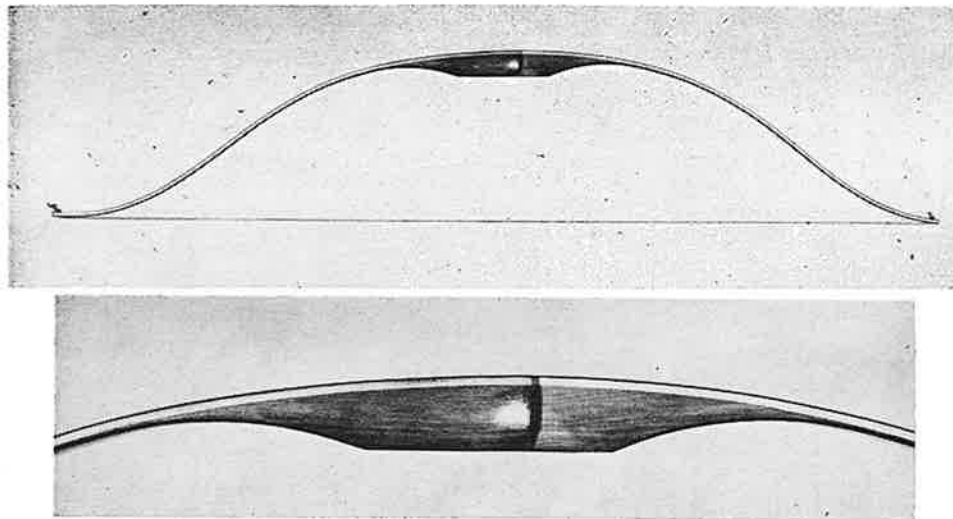

THE BLACK HAWK FLEA BOW is a bow designed for the kiddies from three to ten years old, it is similar to the Mosquito except it is lighter in weight and it comes with a linen or hemp string, has no bow nocks and no wrappings on the handle. The bow is practically indestructible; comes packaged two to a carton, no weights specified.

The Black Hawk Flea—BHF9 List Price **\$8.95**

Left Hand Bows Made To Order—Allow 60 Days for Delivery.

NOTICE — WHEREVER POSSIBLE ORDER BY STOCK NUMBER

ARCHERY SETS



BLACK HAWK MOSQUITO ARCHERY SET consists of: 1 Black Hawk Mosquito Bow with specific weight - 3 Arrows - 1 Tab - 1 Target Face - 1 Arm Guard - 1 Belt Quiver. Beautifully packaged in a telescoping box—An ideal set for the beginner from 8 to 14 years old, and also for the ladies.

BLACK HAWK MOSQUITO ARCHERY SET—MS15 List Price (as illustrated) **\$14.95**
(Note: Shipped 12 sets to a master carton, but will ship in smaller quantities, if desired.)



BLACK HAWK FLEA ARCHERY SET consists of: 1 Black Hawk Flea Bow, no weight specified - 3 Arrows - 1 Tab - 1 Target Face - 1 Arm Guard - 1 Belt Quiver. Beautifully packaged in a telescoping box. An ideal set for kids 3 to 8 years old.

BLACK HAWK FLEA ARCHERY SET—FS11 List Price (as illustrated) **\$10.95**
(Note: Shipped 12 sets to a master carton, but will ship in smaller quantities, if desired.)

BLACK HAWK® KNIFE AND SCISSOR SET

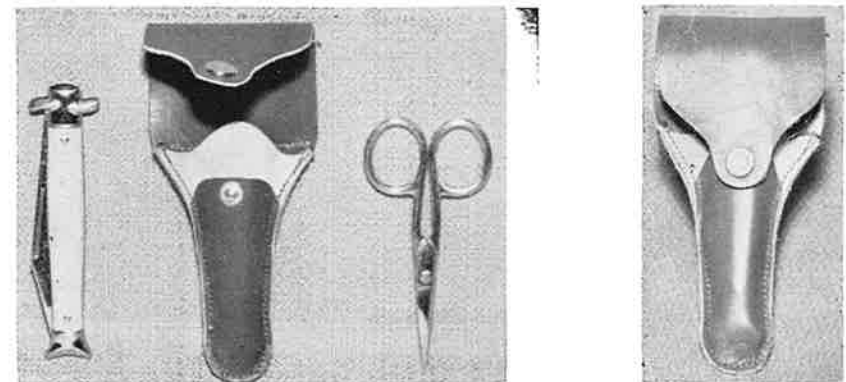

BLACK HAWK SCISSOR SET

Set consists of single blade Knife and one pair of small, pointed Scissors, packaged in a genuine leather Carrying Case. Case has loop to fit belt or quiver harness. An ideal set for the archer, fisherman or outdoors man.

BLACK HAWK SCISSOR SET—BH553 List Price **\$2.95**

NOTICE — WHEREVER POSSIBLE ORDER BY STOCK NUMBER

BLACK HAWK® WHITE QUIVERS

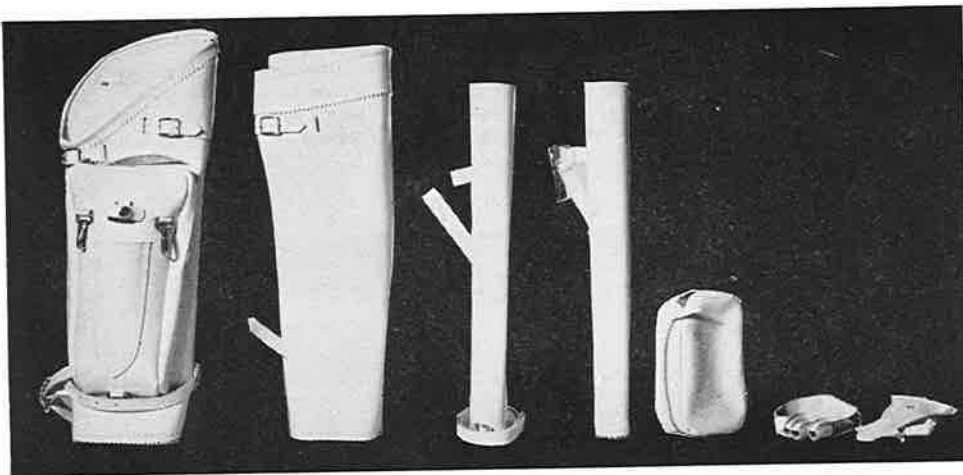

630LW
\$19.95

610W
\$9.75

660W
\$4.50

670W
\$4.50

800W
also in
Brown
800B
\$4.50

520W
\$2.25

300W
\$1.65

The luxurious white quivers, arm guards and gloves are made with top grain white elk. We also produce a No. 630LWB (illustrated on right) which is top grain Brown or Black elk and White, and is a very desirable number which sells for the same price as the No. 630LW. These luxurious white quivers always excite the ladies.

BLACK HAWK® ARM GUARDS AND GLOVES

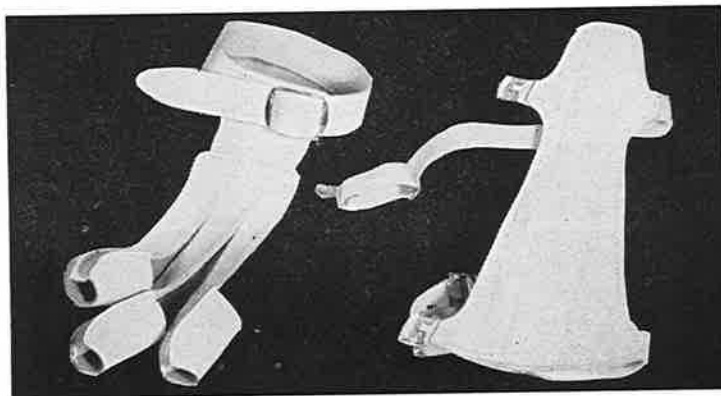

520W
\$2.25

300W
\$1.65



630LWB
\$19.95

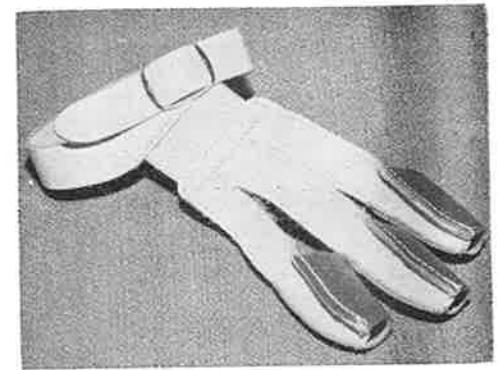

520WT
\$2.25

A two-tone glove made for the ladies. Comes in ladies' large and medium sizes.

BLACK HAWK® TWO-TONE QUIVERS

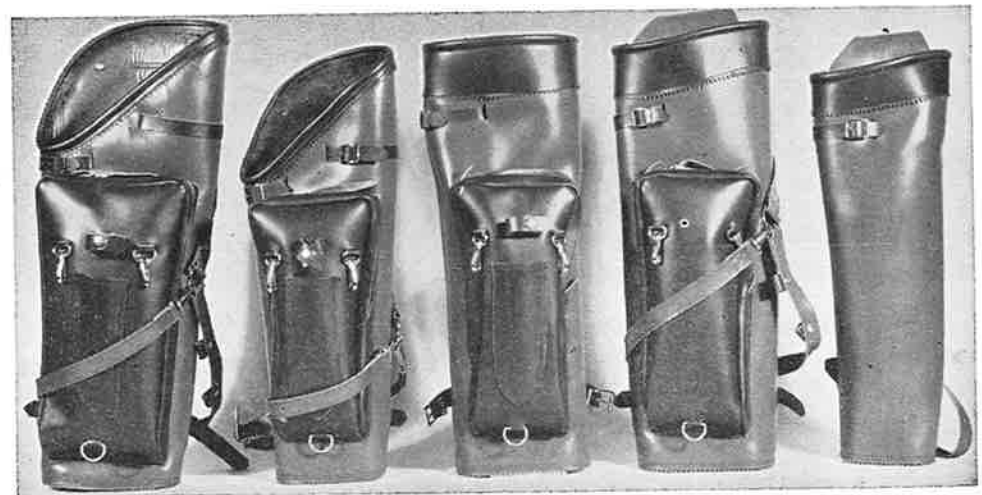

630
Two-Tone
\$19.50

630L
Two-Tone
\$18.50

625
Two-Tone
\$14.95

620
Two-Tone
\$13.95

610
Two-Tone
\$8.95

The specification for the two-tone quivers are identical to the Dark Brown Elk Quivers, except a light-colored top grain brown elk leather is used for the body.

NOTICE — WHEREVER POSSIBLE, ORDER BY STOCK NUMBER.

NOTICE — WHEREVER POSSIBLE, ORDER BY STOCK NUMBER.

BLACK HAWK® QUIVERS



630	630L	625	620	610	600	885
\$19.50	\$18.50	Centerback	\$13.95	\$8.95	\$4.50	Arrabuk
		\$14.95				Brown or Green
						\$2.25

BLACK HAWK DARK BROWN ELK QUIVERS—This quiver is made of the finest top-grain elk available and features two-strap design. Secondary strap, buckled to opposite side of quiver, circles waist and snaps in regular shoulder strap. Adjustable for individual comfort. Harness is included on first four quivers: Nos. 630, 630L, 625 center back, and 620. L following number signifies small quiver suitable for ladies and small men. These quivers have many fine features including pencil holders, file holders, knife sheaths. D-rings for carrying ropes, snap hooks for carrying licenses, etc., and the workmanship is unexcelled.

Specifications: Same quiver as 610, except is designed with harness for center-back wear.

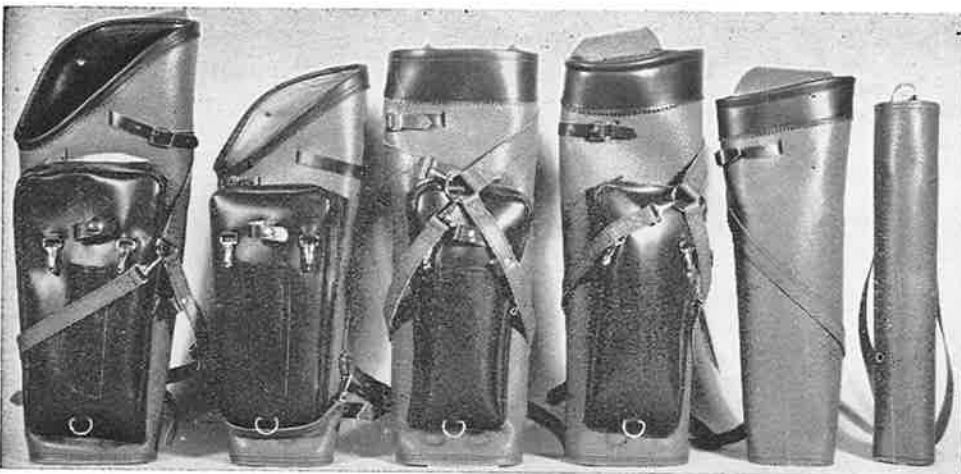

630S	630LS	625S	620S	610S	600S
\$14.95	\$13.50	\$11.95	\$10.95	\$7.50	\$3.95

The Beaver grain quivers carry the same specifications as the Dark Elk and Two-Tone Quivers, except they are made of a split grain leather. These are very popular with most archers.



610CB
\$9.50

Same specifications as 610CB, except made from Beaver grain leather.

BLACK HAWK® ARCHERY BELTS

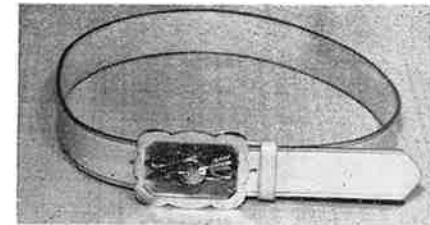

BHB3 1/2

BLACK HAWK ARCHERY BELT (Shown Above) Made of top grade leather, with a beautiful emblem on the buckle, showing a quiver and bow. A must for every archer. Also ideal for prizes at archery field meets. Comes in three sizes: Large, Medium and Small.

BLACK HAWK ARCHERY BELT—BHB3 1/2 List Price **\$3.50**

BLACK HAWK KIDS BELT (Shown Below) with a gold-plated flashy buckle showing a quiver and bow. An ideal number for the kids. Comes in medium and large sizes.

BLACK HAWK KIDS BELT—BHKB1 1/4 List Price **\$1.25**

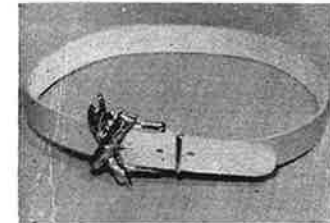

BHKB1 1/4



610SCB
\$7.95

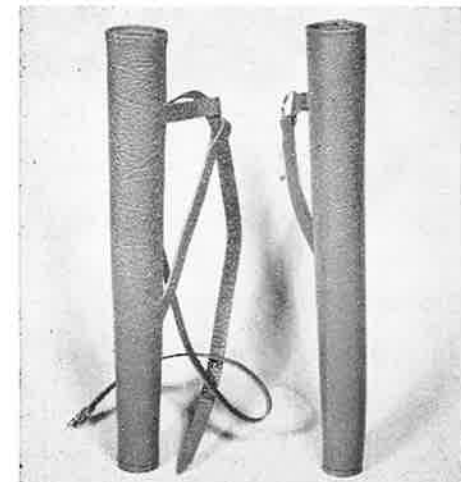

660S
\$3.00

670S
\$3.00

NOTICE — WHEREVER POSSIBLE, ORDER BY STOCK NUMBER.

NOTICE — WHEREVER POSSIBLE, ORDER BY STOCK NUMBER.

FOR THE BEGINNERS AND YOUNGSTERS

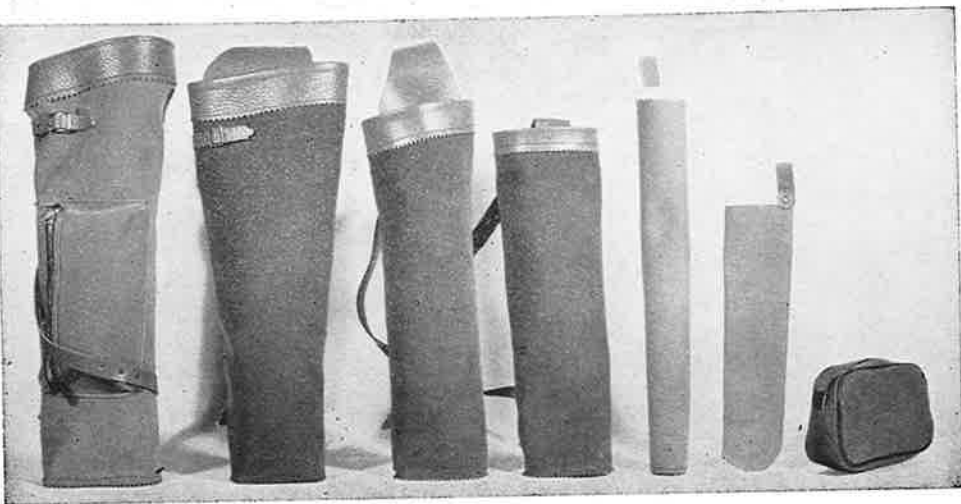

685	684	683	682	650	655	885
\$5.95	\$4.00	\$3.25	\$2.50	\$1.10	50c	\$2.25

One of the finest low-priced quivers in its class. A very fast mover. Available in brown and green.

BLACK HAWK® BOW CASES

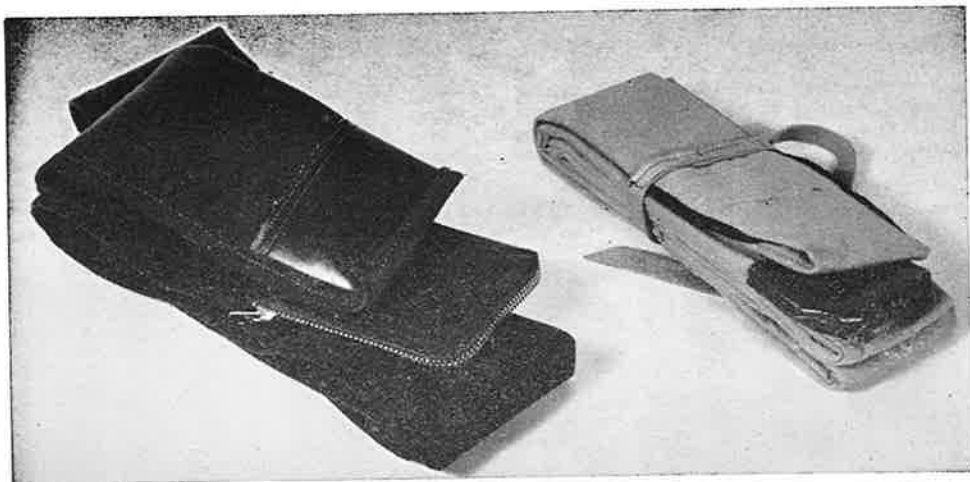

720
\$3.50

700
\$1.65

Arrabuk case has full top zipper and leather reinforced bottom. Canton Flannel case has leather ties.

720	Arrabuk. 2" lengths, 5' to 6'	\$3.50
700	Canton. 62", 66", 72" only	1.65

👉 NOTICE — WHEREVER POSSIBLE, ORDER BY STOCK NUMBER. 👈

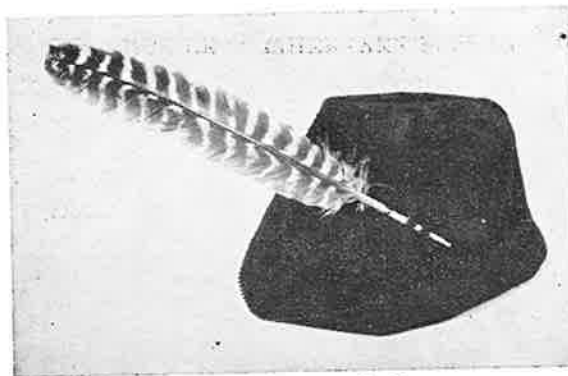

1000 — \$2.95

BLACK HAWK® ARCHERS HAT

Made of very soft suede leather. Available in three colors: red, green and rust.

BLACK HAWK® TABS AND GLOVE TABS

551GT—95c — Cowhide Glove-Tab. Provides glove protection with tab hand-freedom.

550GT—\$1.45—Cordovan Glove-Tab.

550 Small CFT—45c — Cordovan Finger Tab.

551 Large—25c—Cowhide Finger Tab

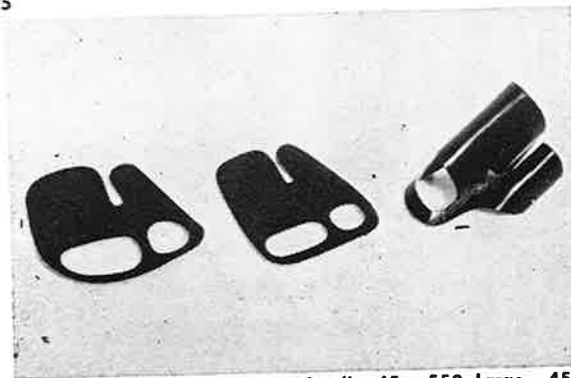

550GT—\$1.45; 250 Small—45c; 550 Large—45c
ILLUSTRATED
551GT—95c; 551 Small—25c; 551 Large—25c
NOT ILLUSTRATED

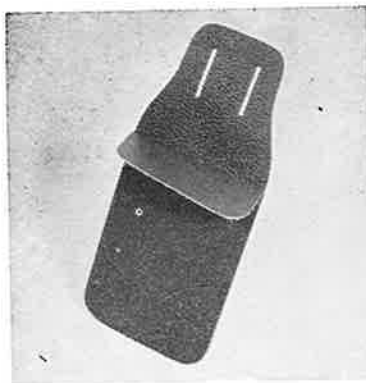

P. Q. — \$1.50

BLACK HAWK® HIP POCKET QUIVER

Has arrow divider, pocket flap, and belt slots.

BLACK HAWK® LEATHER REWRAPPING FOR BOW HANDLES

Skived completely around the strap for ease of application and fitting.

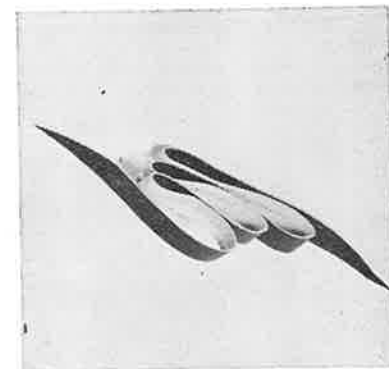

LRW — 60c

👉 NOTICE — WHEREVER POSSIBLE, ORDER BY STOCK NUMBER. 👈

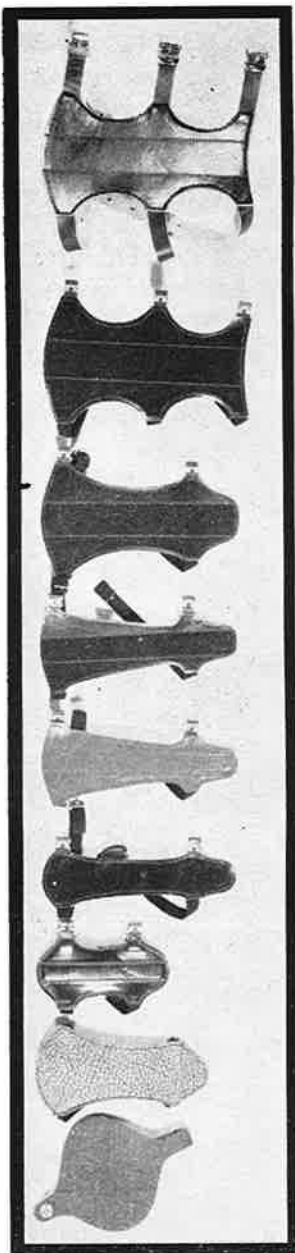

BLACK HAWK® ARM GUARDS

320B—\$3.00

Large, extra width hunting guard with one-inch wide steel stay and three leather straps and buckles to fit over large arm area.

320—\$2.75

Same as 320B, except having elastic bands instead of leather straps.

310—\$2.00

Full length, wide, with one-inch stay for full protection.

300—\$1.50

Semi-narrow, tapered design provides coolness, yet ample protection.

301—\$1.25

Same as 300, but made of Kip leather, not Cordovan.

305—\$1.35

Full length guard, but with extremely narrow design.

300S—\$1.35

"Shorty," only 4¾" long. Favorite with many archers.

300K—75c

Leather guard with Arrabuk lining. Elastic band with hook.

350—50c

Split grain leather for the kids. With adjustable snap fastener.

360U—\$1.00

Upper Arm Guard—A new item for men archers. To be used on the biceps when wearing a blousy shirt or jacket. Made of the finest material.

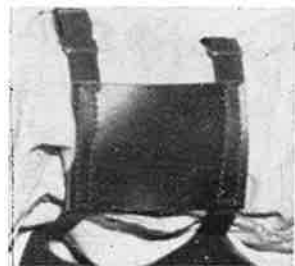

BLACK HAWK® GLOVES

510K—\$1.25

Leather back with open Cowhide tips.

510—\$1.65

Leather back with open Cordovan tips.

520—\$2.00

Open Cordovan tips, elastic insert back.

530—\$2.25

Closed-end styled with Cordovan tips. Elastic insert keeps glove back smooth, and finger stalls snug. Relieves wrist-strap tension.

530K—\$2.00

Same specifications at 530, except tips are made of cowhide.

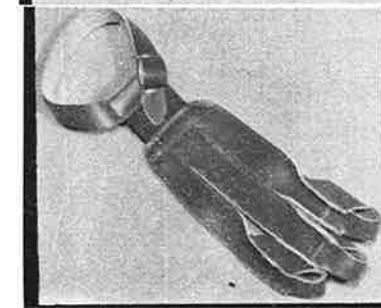

GLOVE SIZES: Men: small, medium, large and extra large. Ladies: medium and large only.

BLACK HAWK® BLOUSE PROTECTOR

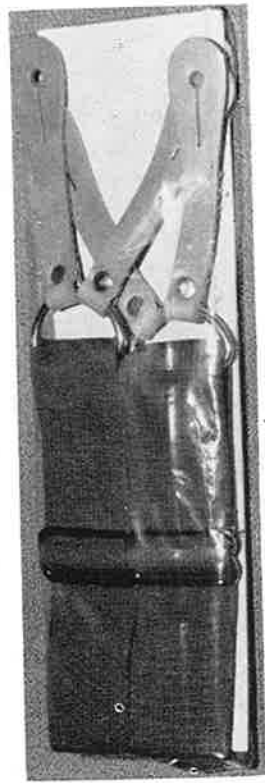
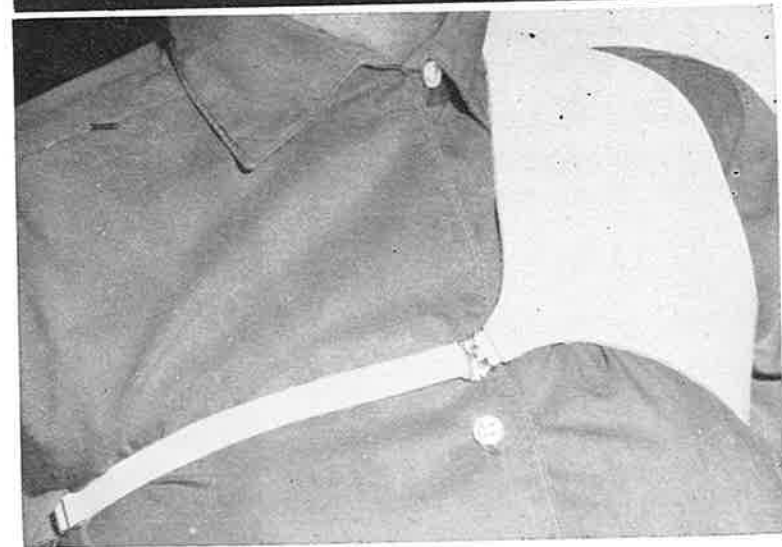
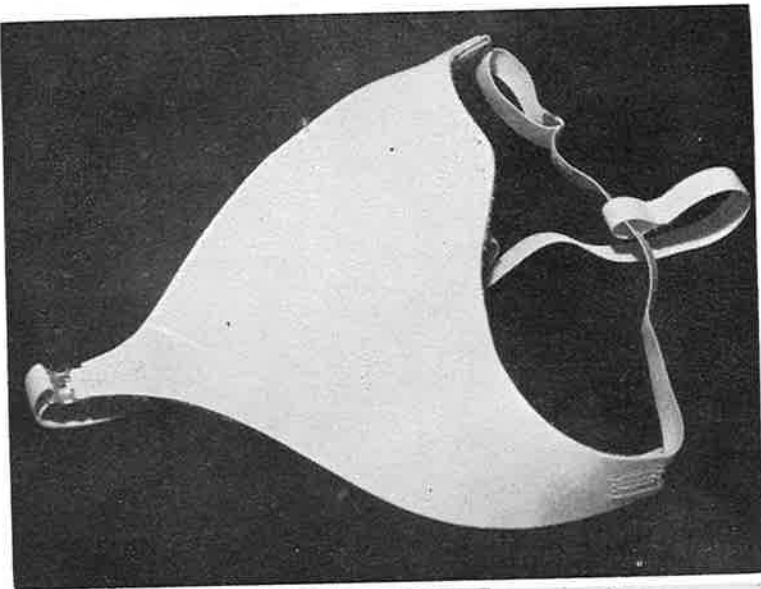

BHSC3

THE BLACK HAWK COMBINATION WADER & HUNTER SUSPENDER—BHSC3
List Price **\$2.25**

Comes in bright red color. Made of the finest elastic obtainable. An ideal item for the archer, fisherman or hunter. Adjustable to fit waders or hunters clothing.



Dacron 4-oz. Spool

Light Weight—D138 List Price **\$3.75** per Spool
Heavy Weight—D207 .. List Price **\$3.30** per Spool



ARROW CLIPS

The perfect clip for tackle boxes, arrow display racks. Made of finest spring steel, nickel-plated over copper and burnished.

ARROW CLIP AND SCREW—AC6
..... List Price **\$5.70 gross**



TASSELS

To Keep Your Arrows Clean!

Tassel—BHT1 List Price **\$1.00** Each



BLACK HAWK VACUUM ARROW KIT—BHVAIK List Price **59c** per Set of 3 Arrows
(Illustrated) A Carded Arrow Set consisting of three Vacuum-tipped Birch Arrows. Ideal for the kids.

NOTICE — WHEREVER POSSIBLE, ORDER BY STOCK NUMBER.

Designed by a lady archer who has been shooting for over 30 years. Used extensively by lady archers. The purpose of this item is to hold down the blouse near the armpit and bust. Made from beautiful top grain leather and elastic. Illustration above shows how it is worn.
BLACK HAWK BLOUSE PROTECTOR—BHBP2 1/2 List Price **\$2.50**



A safe item for the kids. As it flies through the air it whistles and gives the kids a thrill. Packed one to a card as illustrated.
BLACK HAWK WHISTLING ARROWS—BHWA 1/2 List Price **50c** each
NOTICE — WHEREVER POSSIBLE, ORDER BY STOCK NUMBER.

- ALUMINUM TARGET ARROWS—ATA27 List Price **\$27.00 dozen**
- ALUMINUM FIELD ARROW—AFA28 List Price **\$28.00 dozen**
- ALUMINUM BROADHEAD ARROWS—AHA30 List Price **\$30.00 dozen**

ARROWS

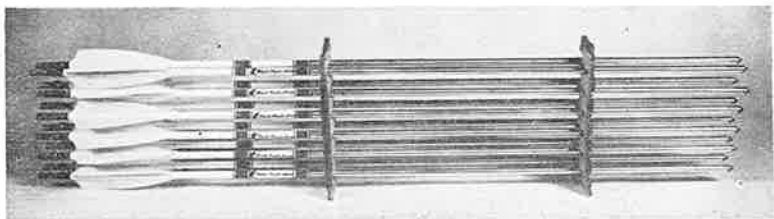

Aluminum Illustrated

Our aluminum is made from an alloy that has been developed specifically for arrows. From this alloy, we then process the aluminum to the highest standards and tolerances that are required for the manufacture of high-grade aluminum arrows. The Black Hawk Aluminum Arrows are in such demand, that at times we are many weeks behind on this fine product. They are used by the most discriminating archers and this alone proves, that the qualities are of the best. The workmanship and material used in this product are the finest available.

No. 1 BLACK HAWK ARROWS in 26" — 27" — 28" Lengths

Custom grade arrows are made from the finest materials that we can purchase. They are closely matched in weight and spine and are beautifully colored and crested. Please specify Bow weight and length of arrow. All arrows are packed 1 dozen to a box.

No. 1 CUSTOM GRADE

- FIELD POINTS—PO1C14F (Illustrated) List Price **\$13.50 dozen**
- TARGET POINTS—PO1C14T List Price **\$13.50 dozen**
- HUNTING ARROWS—PO1C17H (Illustrated) List Price **\$16.95 dozen**

We do not take Orders on any specified custom work

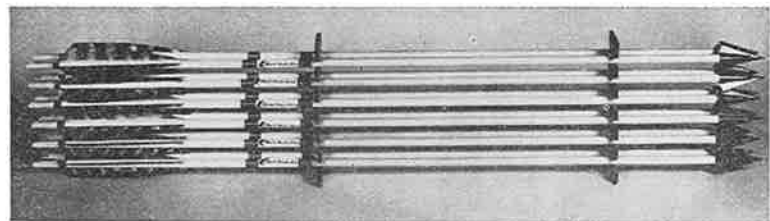

No. 1 Hunting—PO1C17H

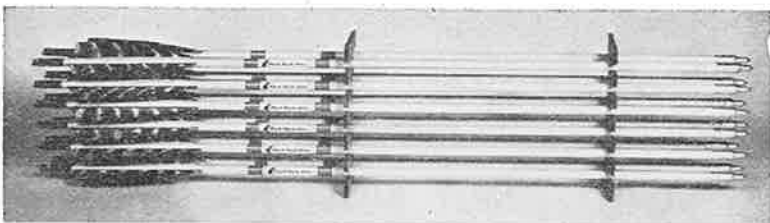

No. 1 Field—PO1C14F

When ordering arrows be sure to specify weight of bow, arrow length and type of hunting point desired, with stock number.

NOTICE — WHEREVER POSSIBLE, ORDER BY STOCK NUMBER.

No. 2 ARROWS (Same specifications as No. 1)

- FIELD POINTS—PO2C12F List Price **\$11.95 dozen**
- TARGET POINTS—PO2C12T List Price **\$11.95 dozen**
- HUNTING POINTS—PO2C15H List Price **\$14.95 dozen**

No. 2 SPECIAL ARROW (as illustrated) is an arrow designed for the man who likes to do his own work. They are carefully made (with the same tolerances as our No. 1 Arrow) of the finest grade of materials available, except they are not cut to length and no points are furnished or installed, and no crest is applied. These small details can be done by the average craftsman with no special tools and many dollars can be saved by his efforts—and still have arrows of the finest quality.

- No. 2 SPECIAL, 4" FEATHERS—PO2S77 (Illustrated) List Price **\$7.70 dozen**
- No. 2A SPECIAL, 5" FEATHERS—PO2SA88 List Price **\$8.80 dozen**

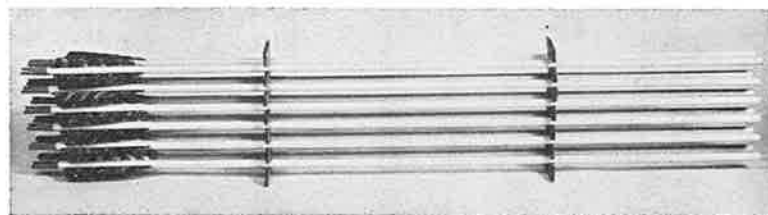

No. 2 Special

No. 3 ARROWS are fully pointed and crested, not spined or matched. Recommend for bows up to 45 lbs.

- FIELD POINTS—3POF8 List Price **\$7.95 dozen**
- TARGET POINTS—3POT8 List Price **\$7.95 dozen**

No. 4 ARROW is an arrow made primarily for the beginner and the kids. They are a very high-grade product for this price and can also be used as a throw-away. They are fully painted and crested, fletched and have 3" Feathers, and are furnished with Target Points Only, in Standard Packs of 6 Dozen, consisting of an Assortment of: 2 dozen 26", 27", 28" Arrows Only, no other packs available.

- Packed 6 Dozen to a Display Box—4POA36 List Price **\$35.70 per Half Gross**
 - Packed 1 Dozen to a Box (Specify Lengths) 4POA7 List Price **\$6.50 per Dozen**
- Lengths Available: 26" 27", 28"

No. 4 SPECIAL—An excellent Birch Kids Arrow, to retail at a price of 29c to 35c. Plastic nock and crested. Not guaranteed to be straight. Made of the best Birch available. Packaged 6 dozen to a rack consisting of: 2 Dozen 22", 24", 26" {6 Doz. Racks Only} BKA22, List Price **\$21.60 per rack**

When ordering arrows be sure to specify weight of bow, arrow length and type of hunting point desired, with stock number.

NOTICE — WHEREVER POSSIBLE, ORDER BY STOCK NUMBER.

THE BLACK HAWK® ARCHERY FISHING OUTFITS



THE BLACK HAWK ARCHERY FISHING OUTFIT is designed for the archer who loves to fish with bow and arrow. It has been proven successful and works as well as outfits costing many times more. It is sold as a complete unit, consisting of: one aluminum fishing arrow, one plastic fishing reel, line included; packaged in an attractive tray, complete with instructions.

List Price

FS4—Complete Unit\$3.75
 FA2—Aluminum Arrow Only\$2.00
 FRL2—Reel and Line Only\$1.75
 FP1—Fishing Points Each \$.85

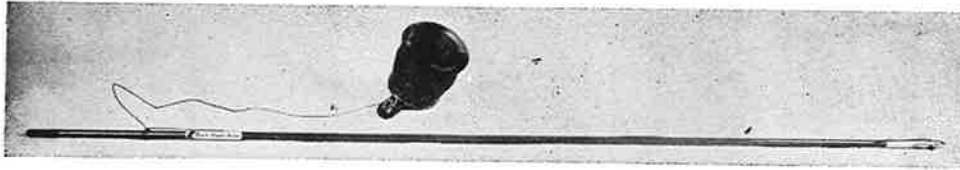

BLACK HAWK® DELUXE FISH REEL

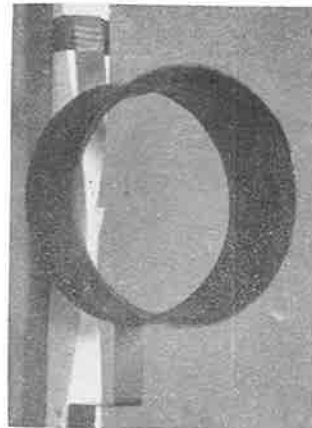
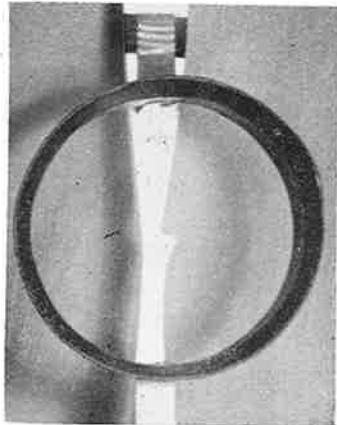

The Black Hawk Deluxe Fish Reel is made of a tough plastic and metal straps to fasten to bow. Has a built-in clip to hold fish line prior to shooting. When shooting at fish with this reel you shoot through the reel, which makes easier shooting. The method for attaching reel is illustrated above. The diameter is approximately 5".

Black Hawk Deluxe Fish Reel—FDR3 List Price (Reel Only) \$2.95

NOTICE — WHEREVER POSSIBLE, ORDER BY STOCK NUMBER.

BLACK HAWK® SPIN SERVER

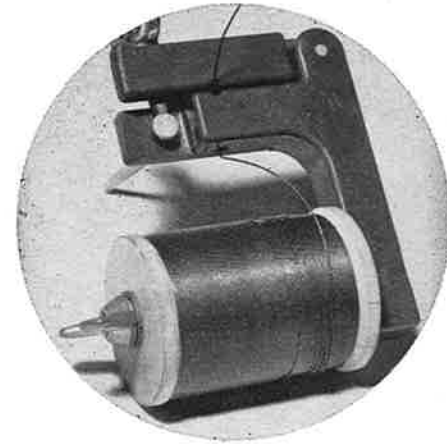

This server is made of a high impact Polystyrene plastic, almost indestructible. It is very simple to use and it is a must and a money saver for all archers. Illustrated above is a complete picture of the product ready for use.

Black Hawk Spin Server—SS3 List Price \$2.95
 (Including Thread to serve approximately 60 Strings)

Packaged one to a package in Polyethylene bag.

Serving Thread Only List Price 60c per Spool

BLACK HAWK® FEATHER BURNER

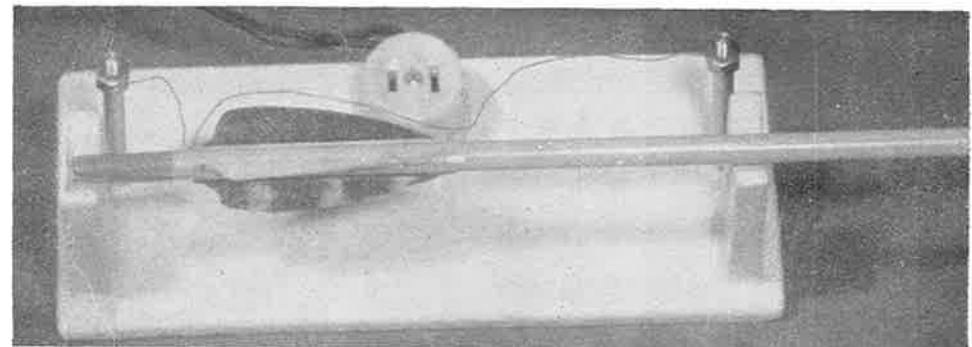

The Black Hawk Feather Burner is not designed for production purposes, but is unexcelled for the home craftsman who wants to repair or rebuild a few dozen arrows. The Burner comes completely assembled, but does not have a transformer. In place of transformer an electric iron is used to reduce the current to the resistance-wire.

The Black Hawk Burner—BHB4 List Price \$3.95
 (Iron or Transformer Not Included)

NOTICE — WHEREVER POSSIBLE, ORDER BY STOCK NUMBER.

RAW MATERIALS

BLACK HAWK® NOCKS



Nock Colors — White, Black, Green, Blue, Red and Yellow
 Nock Sizes — 1/4" - 9/32" - 5/16" - 11/32"

The prices to dealers

NOCK PRICES

Packed in these quantities per package only, one color and one size in each pack.

	List Price
1 Dozen	45c per Dozen
100 Nocks	\$2.50 per Hundred
1000 to 5000 Nocks, one color and one size	\$17.00 per Thousand
5000 to 10000 Nocks	\$16.00 per Thousand
10000 to 25000 Nocks	\$14.00 per Thousand

BLACK HAWK® POINTS

TARGET POINT



FIELD POINT



POINT PRICES

Our points are made of brass and Cadimium Plated and are guaranteed to be of uniform quality in weight and size. All prices are per thousand in reference to quantity lots.

Field Points

	Per 100
3/8 OD — 11/32 ID — 125 Grains	\$6.00
11/32 OD — 5/16 ID — 100 Grains	6.00
5/16 OD — 9/32 ID — 75 Grains	6.00
9/32 OD — 1/4 ID — 60 Grains	6.00
Retail price per dozen — 80 Cents	

Target Points

3/8 OD — 11/32 ID — 60 Grains	\$4.50
11/32 OD — 5/16 ID — 45 Grains	4.50
5/16 OD — 9/32 ID — 30 Grains	4.50
9/32 OD — 1/4 ID — 30 Grains	4.50
Retail price per dozen — 60 Cents	

TARGET POINTS FOR ALUMINUM ARROWS List Price \$3.75 dozen

RAW MATERIALS

ARROW SHAFTS

SHAFTS PORT ORFORD CEDAR

Spined and matched approximately 30" lengths parallel 5/16 and 11/32 diameter. Please do not ask for 5/16 shafts over 35 to 40 lb., as 5/16 shafts do not go over over 40 lbs.

5/16 and 11/32	\$3.50 Dozen
5/16 and 11/32	\$26.00 per 100
5/16 and 11/32	\$220.00 per 1000 (when available)

FEATHERS

	Dozen	100
Barred	\$.90	\$5.50
Dyed Barred	1.00	7.00
Natural White	1.45	7.50
Dyed White	1.60	9.00

The feathers in dozen lots come beautifully packaged in cellophane packages.

WHISTLES

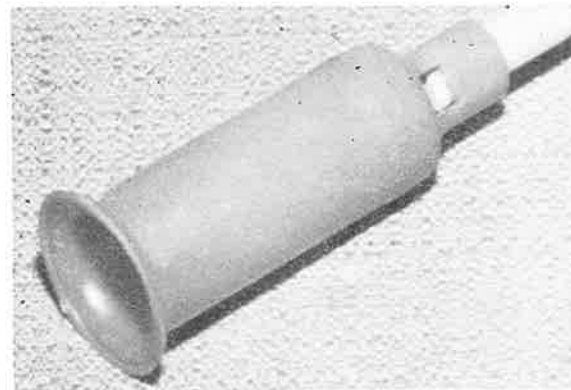

Plastic Whistles—An ideal item for rebuilding your old arrows into whistling arrows for the kids.

Whistles—PWT List Price \$4.20 Dozen

VACUUM CUP

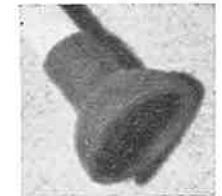

Vacuum Cup—VC
 List Price 35c Dozen

An ideal item for rebuilding your old arrows into kid's arrows.

NOTICE — WHEREVER POSSIBLE, ORDER BY STOCK NUMBER.

NOTICE — WHEREVER POSSIBLE, ORDER BY STOCK NUMBER.

Black Hawk® Bow String Wax — Black Hawk® Ferrule Cement



Unexcelled for Synthetic and Linen Bow Strings

35c Each — \$4.20 a Case of 12, List Price.



Unexcelled for Archery & Fishing Tackle

DIRECTIONS: Heat the cement over a match, candle or flame, dropping the cement on the portion of the arrow shaft or arrow point. Then heat the metal hot enough to melt the cement, pushing the two objects together. Chill with cold wet cloth.

35c Each—\$4.20 a Case of 12. List Price.

BLACK HAWK® FLETCHING CEMENT

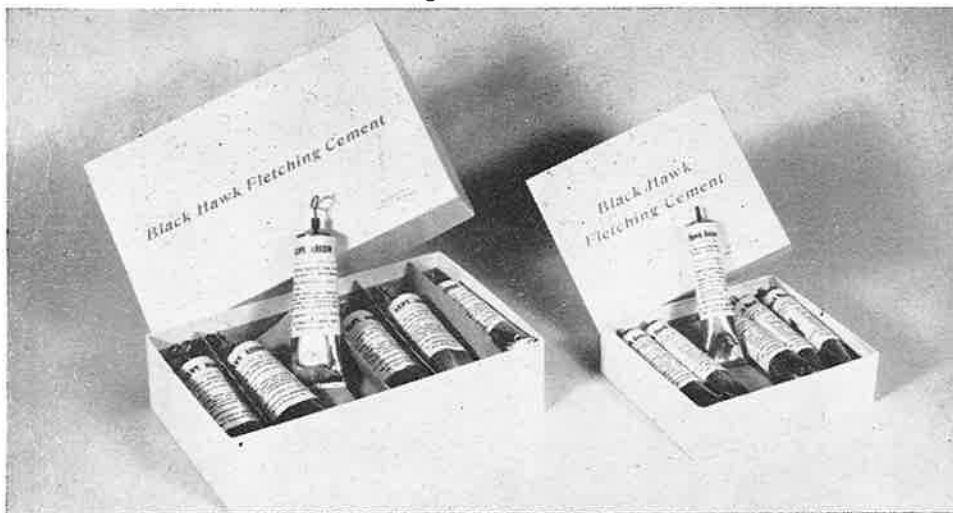

TYPE W

Unexcelled for glueing feathers and nocks to wooden arrows. Can also be used for metal arrows.

DIRECTIONS: Make sure objects to be cemented are clean. Apply thin coat of cement to each surface. Hold together firmly until set. Cement is transparent, waterproof and dries quickly.

Contents approximately 1 1/4 fluid ounces.

35c Each—\$4.20 Case of 12. List Price

TYPE M

Unexcelled for glueing feathers and nocks to metal arrows. Also used for wooden arrows.

DIRECTIONS: Make sure objects to be cemented are clean. Apply thin coat of cement to each surface. Hold together firmly until set. Cement is transparent, waterproof and dries quickly.

Contents approximately 3/4 fluid ounce.

35c Each—\$4.20 Case of 12. Price List.

NOTICE — WHEREVER POSSIBLE, ORDER BY STOCK NUMBER.

BLACK HAWK® WATERPROOFING



FOR ARROWS AND FLIES

Does Not Stiffen Feathers

Directions: Apply Waterproofing to the fletching or fly with applicator. Let dry for a few minutes and arrow or fly is ready to use.

Contents: One Fluid Ounce

Packed 12 to a Case, 50c Each

List Price, \$6.00 a Case

THE BLACK HAWK® PLASTIC VEIN

This Vein is not designed to take the place of feathers, but is a vein of plastic and many thousands of target archers love to shoot arrows with a plastic vein. Once they learn to shoot with a plastic vein, they can always increase their score from 10 to 35%. The demand for this item will greatly increase. Colors: Red, white, yellow and green.

List Price of 2" Vein 3c each

List Price of 2 3/4" Vein 3c each

List Price of 3 1/4" Vein 4c each

Please specify Size and Color of Vein.



NOTICE — WHEREVER POSSIBLE, ORDER BY STOCK NUMBER.

Black Hawk® Components

MERCHANDISING DISPLAY

— Complete —



- 1 Doz. Pkgs. 5/16" Nocks (12 to Pkg.) @\$.45 per Pkg.
- 1 Doz. Pkgs. 5/16" Target Points (12 to Pkg.) @60 per Pkg.
- 1 Doz. Pkgs. 11/32" Nocks (12 to Pkg.) @45 per Pkg.
- 1 Doz. Pkgs. 11/32" Target Points (12 to Pkg.) @60 per Pkg.
- 1 Doz. Pkgs. 5/16" Field Points (12 to Pkg.) @80 per Pkg.
- 1 Doz. Pkgs. 11/32" Field Points (12 to Pkg.) @80 per Pkg.
- 1 Doz. Pkgs. Assorted Bowstrings (1 to Pkg.) @35 per Pkg.
- 1 Doz. Pkgs. Assorted Dacron Bowstrings (1 to Pkg.) @ 1.25 per Pkg.
- 1 Doz. Pkgs. Broadheads (3 to Pkg.) @ 1.00 per Pkg.

The above items are included in the Merchandiser Display.

Packages are of tough, clear plastic and are available in any amount with or without display rack.

Complete Unit As Listed Above—BHMD75 **\$75.00**

The above prices are the List Prices of Individual Packages.

👉 NOTICE — WHEREVER POSSIBLE, ORDER BY STOCK NUMBER. 👈

BLACK HAWK® TAPERING TOOL

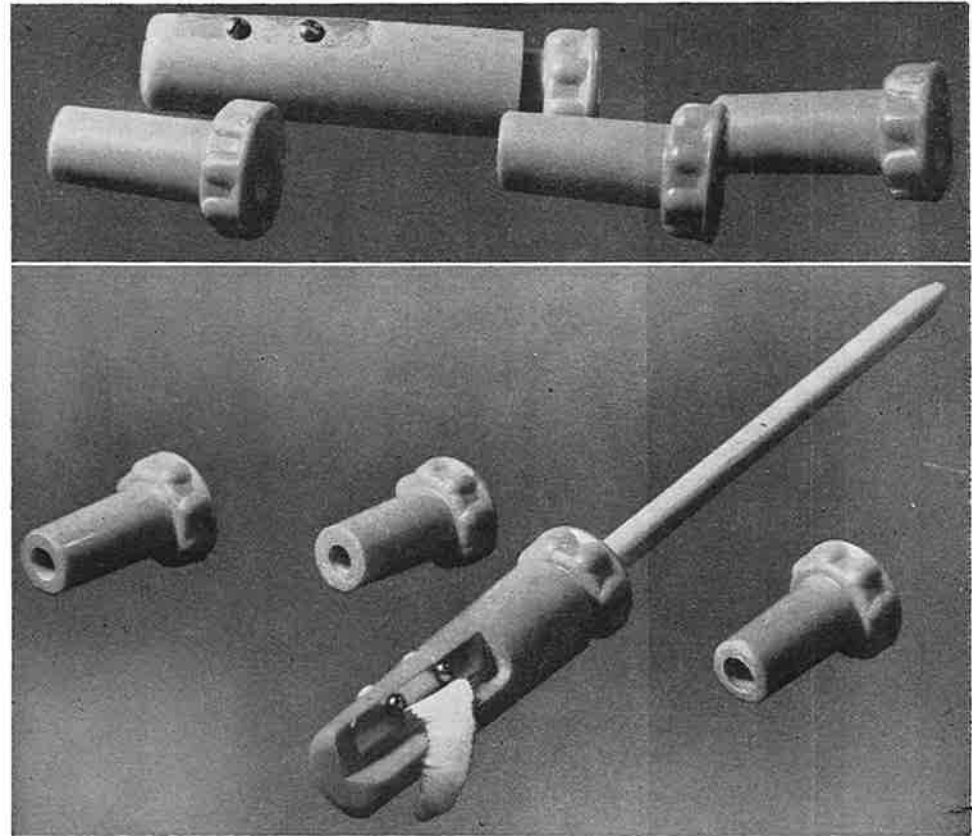

This tapering tool will fit 99% of all points and nocks made, also included are four bushings. The bushings have tapered sleeves which fit in a tapered hole and when pressed into the main body firmly they will fit snugly. The sizes of these bushings are 1/4", 9/32", 5/16", and 11/32". All these bushings are oversize to permit clearance of oversize shafts and also for shafts that are painted. To use this tool insert the bushing that corresponds to the shaft size and rotate the shaft clockwise until the tool stops cutting. Your job is then complete.

The blades that are used in this tool are regular injector type blades similar to Schick or other type injector razors. They can be purchased practically at any drug store in the country, costing around 10c a piece. You do not have to buy special made blades at 50c or more per blade. The plastics that are used in this tool are of a very high standard and if the tool is used properly, it should give you many years of trouble-free service.

Black Hawk Tapering Tool—BHHT4 List Price **\$3.50**

👉 NOTICE — WHEREVER POSSIBLE, ORDER BY STOCK NUMBER. 👈

BLACK HAWK® STRINGS

String Length	String Weights				List Price
49"	40-50#				\$1.35
50"	40-50#				\$1.35
51"	40-50#				\$1.35
52"	40-50#				\$1.35
53"	40-50#				\$1.35
53½"	30-40#	40-50#	50-60#	60-75#	\$1.35
54"	30-40#	40-50#	50-60#	60-75#	\$1.35
54½"	30-40#	40-50#	50-60#	60-75#	\$1.35
55"	30-40#	40-50#	50-60#	60-75#	\$1.35
55½"	30-40#	40-50#	50-60#	60-75#	\$1.35
56"	30-40#	40-50#	50-60#	60-75#	\$1.35
56½"	30-40#	40-50#	50-60#	60-75#	\$1.35
57"	30-40#	40-50#	50-60#	60-75#	\$1.35
57½"	30-40#	40-50#	50-60#	60-75#	\$1.35
58"	30-40#	40-50#	50-60#	60-75#	\$1.35
58½"	30-40#	40-50#	50-60#	60-75#	\$1.35
59"	30-40#	40-50#	50-60#	60-75#	\$1.35
59½"	30-40#	40-50#	50-60#	60-75#	\$1.35
60"	30-40#	40-50#	50-60#	60-75#	\$1.35
60½"	30-40#	40-50#	50-60#	60-75#	\$1.35
61"	30-40#	40-50#	50-60#	60-75#	\$1.35
61½"	30-40#	40-50#	50-60#	60-75#	\$1.35
62"	30-40#	40-50#	50-60#	60-75#	\$1.35
62½"	30-40#	40-50#	50-60#	60-75#	\$1.35
63"	30-40#	40-50#	50-60#	60-75#	\$1.35
63½"	30-40#	40-50#	50-60#	60-75#	\$1.35
64"	30-40#	40-50#	50-60#	60-75#	\$1.35
64½"	30-40#	40-50#	50-60#	60-75#	\$1.35
65"	30-40#	40-50#	50-60#	60-75#	\$1.35
65½"	30-40#	40-50#	50-60#	60-75#	\$1.35
66"	30-40#	40-50#	50-60#	60-75#	\$1.35
67"	30-40#	40-50#	50-60#	60-75#	\$1.35
68"	30-40#	40-50#	50-60#	60-75#	\$1.35
69"	30-40#	40-50#	50-60#	60-75#	\$1.35
70"	30-40#	40-50#	50-60#	60-75#	\$1.35
71"	30-40#	40-50#	50-60#	60-75#	\$1.35
72"	30-40#	40-50#	50-60#	60-75#	\$1.35
6' String Single Loop	30-40#	40-50#	50-60#	60-75#	\$1.35
60½" Yellow Jackets	30-40#	40-50#	50-60#	60-75#	\$1.35
47½" Mosquito		30-40#		List Price	\$1.00
53½" Scorpion	30-35#	40-50#		List Price	\$1.35
Kids Hemp Strings — Length 4'6" to 5'					\$.35
Kids Hemp Strings — Length 5' to 5'6"					\$.35
Kids Hemp Strings — Length 5'6" to 6'					\$.35

CHART — Showing Lengths of String for Various Bows

ACTIONBOW —Model #8200, 55 in. - #8400, #8600, 56½ in. - #8800, 59½ in.
APPOLO —Swallow, 51½ in. - Marlin, 56 in. - Kestrel, 57 in. - Condor, 60¼ in. - Falcon, 63½ in.
BEAR —Cub, Grizzly, Kodiak K2, Old Polar, 58½ in. - Kodiak K4, Kodiak II, 5 ft. 4 in.; New Polar, Kodiak 5 ft. 4 in., Kodiak Special, 60½ in. - Kodiak K6, 62½ in. - Kodiak II 4 ft. 8 in., Kodiak 4 ft. 8 in., 52½ in. - Kodiak II 5 ft., Kodiak 5 ft., 56½ in. - Kodiak Special 5 ft. 8 in., 64½ in.
BLACK PALM —Nsh2a, 59½ in. - Ultra Sh. Hornet, 54½ in.
BLACK HAWK —Short Hornet, Short Wasp, Short Bee, Scorpion, 53½ in. - Long Hornet, Long Wasp, Long Bee, Warrior, 57½ in. - Chief, 64 in. - Yellow Jacket, 60½ in. - Mosquito, 47½ in.
COE —Wolverine, All-purpose, 56 in. - Deerfield, Paragon, 61 in. - Wolverine Hunter, 58 in. - Wolverine Super, 60 in.
EDDINGS —Trojan 5 ft. 2 in., Spartan, 5 ft. 2 in. 58½ in. - Scout, Cadet, Fireball, 5 ft. 4 in., 60½ in. - Duo-flex, Trojan 5 ft. 6 in., Spartan 5 ft. 6 in., Sphinx, 62½ in. - Fireball 5 ft. 8 in., 64½ in.
EICHOLTZ —Venus, 58½ in. - Neptune, 62½ in. - Saturn, 65½ in. - Jupiter, 68½ in.
FOLBERTH —5 ft. 6 in., 62½ in. - 5 ft. 8 in., 64½ in.
GRIMES —Lightweight, 51 in. - Hunter 40#, 45#, 54¾ in. - Hunter 50#, 55#, 60#, 53 in. - Standard 45#, 50#, 55#, 57½ in. - Standard 60#, 55¾ in. - Grimes Jr. 25#, 30#, 51¼ in. - Grimes Jr. 35#, 40#, 53¾ in. - Grimes Sr. 35# to 60#, 55 in.
HOYT —5 ft. Bow, 56½ in. - 5 ft. 2 in. Bow, 58½ in. - 5 ft. 3 in. Bow, 59½ in. - 5 ft. 6 in. Bow, 62½ in. - 5 ft. 9 in. Bow, 65½ in.
IVANHOE —Junior Flex, 57 in. - Student Flex. 61 in. - Deflex, Superflex, Power King, 63 in. - Deflex Superflex, Power King, 65 in.
KITTREDGE —Apache M, 65 in. - N, 63 in. - O, 61 in. - Arrowmaster 12 Series, 68½ in. - 9 Series, 66 in. - 6 Series, 63 in.
NA-PO —5 ft. 4 in., 60½ in. - 5 ft. 6 in., 62½ in. - 5 ft. 9 in., 64½ in.
OUTDOOR SPORTS —#1253, 2453, 59 in. - #2155, 2555, 2655, 2755, 4802, 4804, 4806, 61½ in. - #2559, 64 in. - Fawn, 57 in. - Fibre Glass #3445, 54 in. - #3050, 55 in. - #3153, 58 in.
PAR-X —Champ, 50 in. - 40# Spcl, 55 in. - 35# Spcl, 65#, 70#, 56 in. - 30#, 45#, 50#, 60#, 58 in.
PEARSON (BEN) —500, 500R, 601, 765, 302, 57 in. - 304, 60½ in. - 606, 766, 501, 501R, 502, 503, 701, 775, 306, 63 in. - 769, 66 in.
PIERSON (E. BUD) —Sultan 26, 50 in. - Sultan 27, 52 in. - Sultan 28 and 62, 58 in. - Chester, 62 in. - Rex, 65 in. - Turk, 55½ in.
PARALLEL PLASTICS —Parabow Hunter, 49 in. - Sharpshooter, 56¾ in. - Glasflex 26B, 60½ in. - Glasflex Jr. 29E, 56¾ in.
PAUL BUNYAN —Scout #400, 52½ in. - Custom Recurve #100, 56½ in. - Recurve #300, Straight #500, 60½ in.
PLY-FLEX —Archer, 54½ in. - Sherwood, Sportsman, Big Game, 55½ in.
ROBIN HOOD —Tox, 49 in.
SEE-FAB —Diana, 55 in. - Centaur, Tiger, 61 in.
SEDERQUIST —Short Bow, 54 in. - Long Bow, 56 in.
STREAM-EZE —Model #20, 40½ in. - #30, 50¼ in. - #35, #40, 51¼ in.
WHITE —Venus, 58½ in. - Neptune, 62½ in. - Saturn, 65 in. - Jupiter, 68 in. - Mercury, 61 in. - Custom 5 ft. 2 in., 58½ in. - Custom 5 ft. 6 in., 62 in. - Custom 5 ft. 9 in., 65 in. - Custom 6 ft., 68 in.
WITHINGTON —Jaguar #70, 42½ in. - #71, 46½ in. - #72, 52½ in. - Collegiate #200, #210, Game Hunter #250, 260, 55¼ in.
YORK —Super Crest #DRG-1, Crest #DRG-2, 60½ in.

NOTICE — WHEREVER POSSIBLE, ORDER BY STOCK NUMBER.

BLACK HAWK® ADJUSTABLE BOW SIGHT

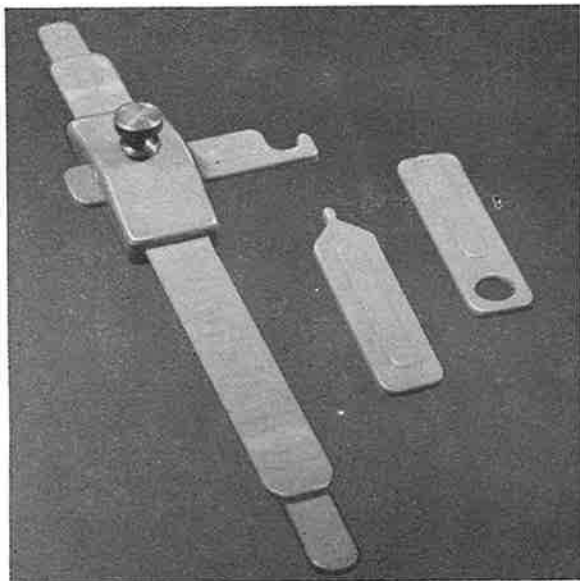

Kit consists of Black Hawk® Adjustable Bow Sight and two extra apertures. To adjust this sight loosen the thumb screw. You can move the body of the sight up and down for elevation and the apertures in and out for windage. The position on your sight can then be marked for permanent sighting records.

Black Hawk Adjustable Bow Sight—BHBS2 List Price **\$1.75** each

THE BLACK HAWK® BOW NOCK

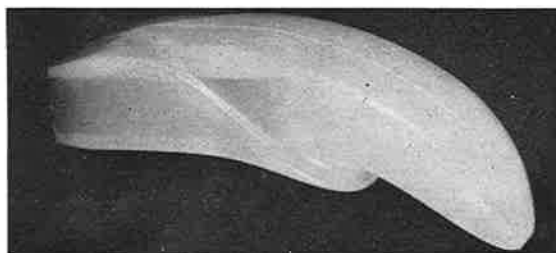

THE BLACK HAWK BOW NOCK is made from nylon and is practically indestructible. It is used by the amateur bow maker, and also for repairing old bows. The illustration is approximately two times larger than the actual nock. The hole size is 1/2"x3/16"x1" deep. List Price, per Pair, **\$1.00**.

👉 NOTICE — WHEREVER POSSIBLE, ORDER BY STOCK NUMBER. 👈

THE BLACK HAWK® BOW QUIVER

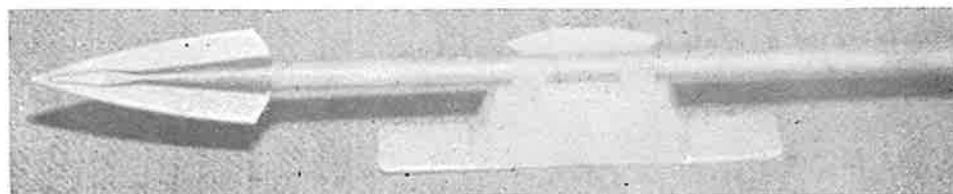
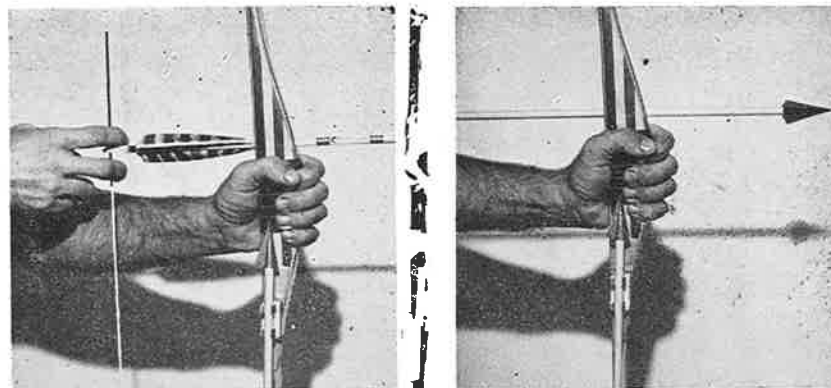

THE BLACK HAWK BOW QUIVER is without a doubt the lowest priced quiver on the market. It was tested and proved for two hunting seasons. It is an article that no archer-hunter would be without once he sees it. The purpose of this quiver is to have an arrow at archer's hand the moment he releases his first arrow with the minimum amount of movement for the second shot, which is very important in archery hunting. This quiver does not eliminate the need for a back or shoulder quiver, but the purpose is to give the archer the second arrow quickly and silently, when needed in a hurry. The instructions for applying this quiver are very simple—all that is needed is adhesive or friction tape, and in a few seconds the quiver is attached to the bow in the position the archer may want it, either back or side of bow, as illustrated. (Note: Below archer's hand.)

Black Hawk Bow Quiver—BHBQ1 List Price, **\$1.00** Each

BLACK HAWK® TARGET STAPLES

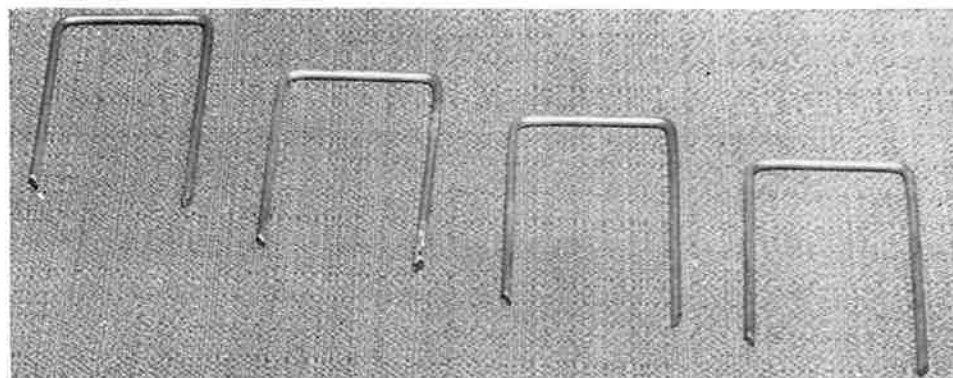

Black Hawk Target Staples are used to fasten targets to straw targets or bales of hay. Packed 4 to a set.

Black Hawk Target Staples—STAP List Price, **35c** per Set

👉 NOTICE — WHEREVER POSSIBLE, ORDER BY STOCK NUMBER. 👈

BLACK HAWK® CAMOUFLAGE BOW TAPE

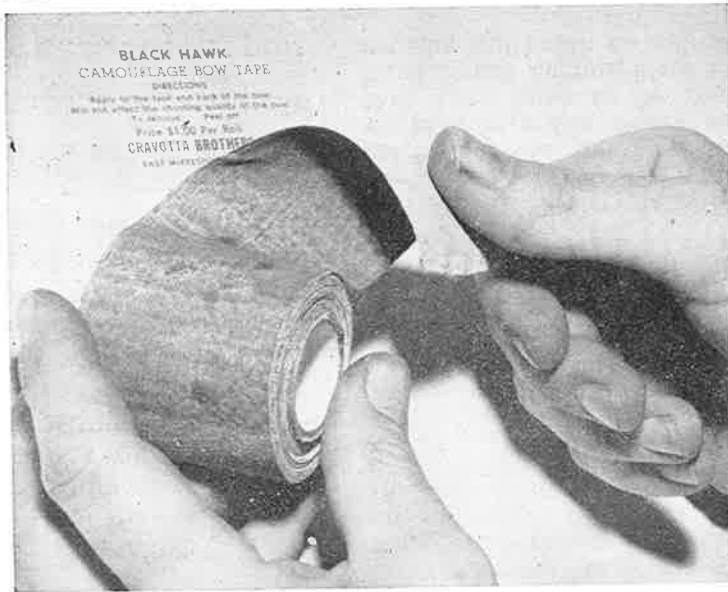

DIRECTIONS

Black Hawk® Camouflage Bow Tape is a cloth with a pressure type adhesive which can be easily removed when not needed on bow. It will not affect the cast of the bow and the color is an olive green speckled with blemishes, and makes the bow blend very well with the forest and fields. This is an item wanted by all archer hunters. There is sufficient tape in one roll to cover any bow up to six foot in length.

DIRECTIONS—Remove tape from roll and apply longitudinally along the length of the bow and fold tape over where bow tapers. Can be applied to the back and front of the bow if so desired or on one side only.

To remove — Peel off!

Black Hawk Camouflage Bow Tape—CATA List Price **\$1.00**

BLACK HAWK IDENTIFICATION DECALS INSTRUCTIONS

List Price 20c per sheet
12 Decals to a sheet

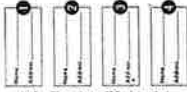
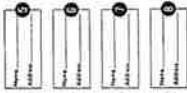
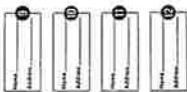

List Price 20c per sheet — 12 Decals to a sheet

BLACK HAWK IDENTIFICATION DECALS

12 Decals to a Sheet

List Price, **20c** per Sheet

Illustration 1/4 Size of Actual Sheet.

NOTICE — WHEREVER POSSIBLE, ORDER BY STOCK NUMBER.

Black Hawk® Nocking Point 25c Each



This device is made of a tough, durable plastic. It is almost impossible to wear it out. It has been used in several tests and shot thousands of times without showing signs of wear.

The purpose of this nocking device is to give the archer a permanent nocking position on his bow. The nocking position on the bow is one of the most important fundamentals for good shooting. This question is often asked by new archers: Where should you nock an arrow? This device

is the answer for simplifying and maintaining the proper location for a permanent nocking point. If used properly it should increase your score 25% in field and target shooting. For hunting it is indispensable, as it will eliminate the possibility of the arrow slipping away from the proper nocking position. Directions for applying this nocking point are simple, as shown in sketches below.

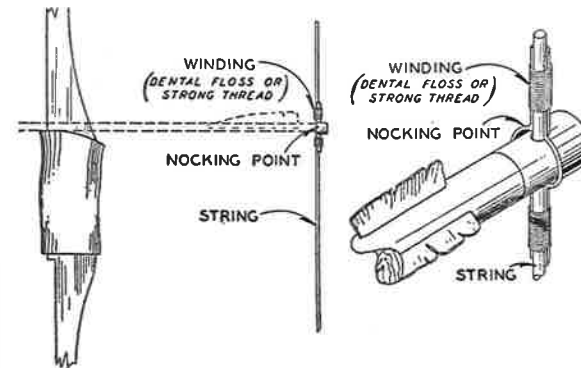

When applying this device to a new string, be sure that the string has reached its maximum stretch. This can be accomplished by bracing the bow and shooting it a few dozen times (on an old string this not necessary). Then locate the exact position that you nock your arrow, which is normally 1/8" above arrow plate. Mark this spot with a pencil and then set the nocking point on the string, with the mark in the center of the cup. Wrap the legs of the nocking device with dental floss or good, strong thread, making sure it is secure. When the device is put on properly, in a shooting position, the cup should be pointed toward you. If it is at a slight angle it will not affect your shooting.

If the nocks are slightly large and fit snugly, or slightly small and fit loosely, this will not affect your shooting. Your bow is now ready to shoot, as for the nocking position being right.

May we wish you good luck and an improved score.

NOTICE — WHEREVER POSSIBLE, ORDER BY STOCK NUMBER.

ONE DOZEN ASSORTED SIZES

BLACK HAWK NOCKING POINTS

A MUST FOR EVERY ARCHER
SIZES TO FIT EVERY NOCK
25c Each 25c Each

CRAVOTTA BROTHERS
Third Street - East McKesport, Pa.

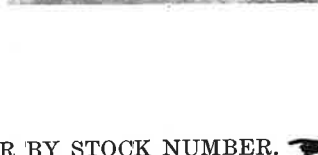
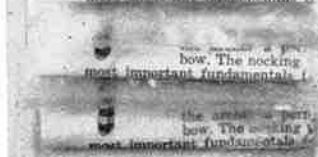
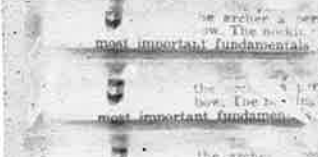

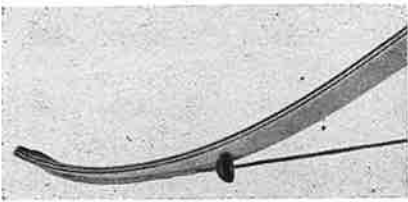

STANDARD

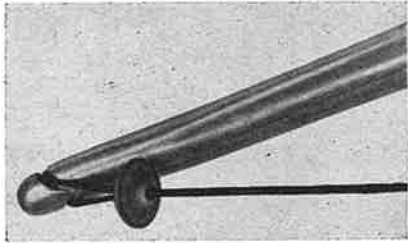

SUPER

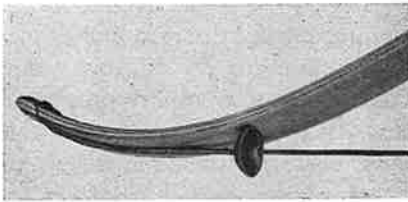

SUPER

"STANDARD"

Mounted on Full Working Recurve.

"SUPER"

Mounted on Full Working Recurve.

"SUPER"

Mounted on Straight Bow.

Recommend Supers for any bow.
Standards for narrow limb bows,
but can be on any bow.

Especially effective on the highly
stressed semi and full working
recurves.

SUGGESTED RETAIL PRICE

Super **60c** per pair

Standard **50c** per pair

Pat. No. 2,617,402

- Does not interfere with bracing or unbracing.
- Does not interfere with cast or accuracy.
- Light weight — manufactured of special formulated rubber.
- Lengthens string life.
- Universal size—Fits all bows.
- Acclaimed by bow hunters everywhere.

*The Purpose of
Brush Buttons*

DAMPENING ACTION — Whenever a highly stressed bow is shot the string vibrates producing a hum. Harmonics (over tones) travel the string and establish other frequencies that are of many pitches — the combined overall result is a buzzing noise which continues after the shot. In hunting this effect continues after release, allowing the game to pin point the hunter and in many cases the game has "jumped" the arrow (moved before the arrow got to it). You cannot eliminate the original "crack", or noise of the string cutting through the air, as it propels the arrow, nor is it necessary as in the woods any number of things produce a sharp noise; acorns dropping, dead limbs falling, etc. This noise is not especially frightening to deer and other game, but the after effect of humming has no match in nature. Brush Buttons mounted on the string dampen this after effect especially the higher frequency, because they must be moved in the frequency of the string for it to continue to hum.

BRUSH PROOFING ACTION—When afield brush, grass, berry stems, etc., catch between the bow and string working into the wedge so tightly, that they have to be removed by hand. Brush Buttons block this wedge causing the brush to deflect out.

**BLACK HAWK®
ECONOMY TARGET**

The target is made from heavy corrugated paper. It can be assembled by opening the box and taping it. It is then packed tightly with shredded paper or straw. The four-color face is printed on the carton. A very economical target.

Black Hawk Economy Target—BEC

List Price, **\$1.00**

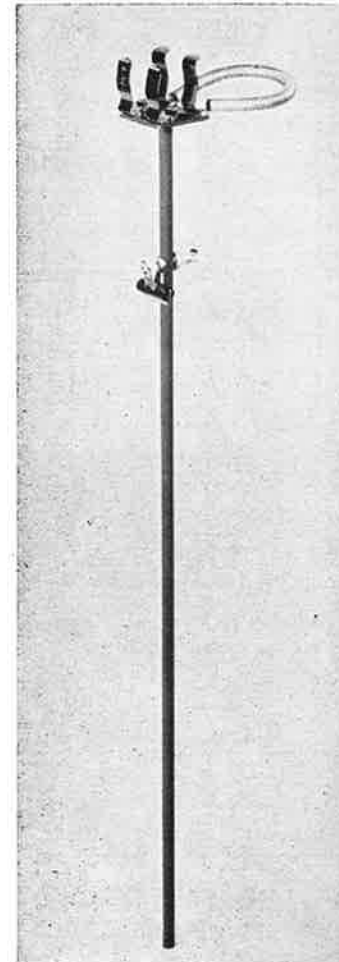
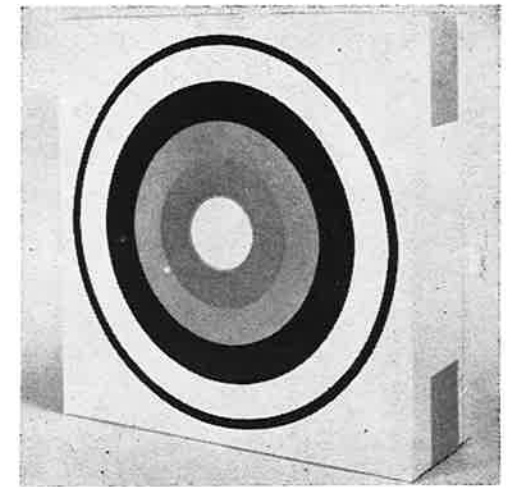

BLACK HAWK® GROUND QUIVER

AS ILLUSTRATED

Many fine features that are not
found in other ground quivers.

Black Hawk Ground Quiver—GQ

List Price, **\$3.30**

BLACK HAWK® CORRUGATED TARGET FACES

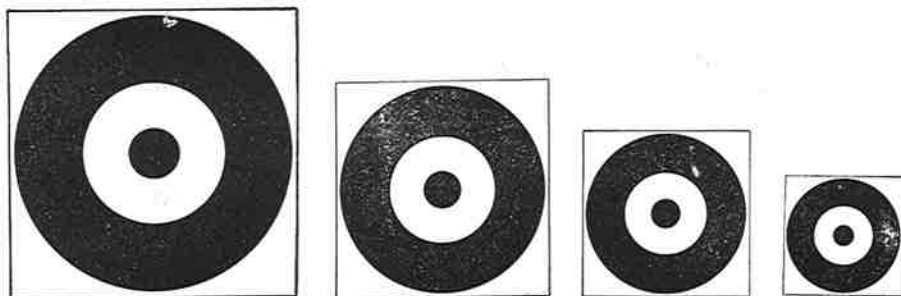

These Target Faces are made in accordance with the N.F.A.A. hand book for field shooting. They are made of heavy corrugated paper and the shooting spot is heavy black with the background in white. These targets will save a club many hours in preparing for a shoot. These targets will outlast most any target on the market because of their heavy construction. During rainy weather these targets can be waterproofed by immersing for a moment in moulten parrafine. The targets come in the following arrangements:

A complete 36 Target set consisting of four 24", six 18", eight 12", eighteen 6" Faces — \$8.00 list price.

- 12 - 6" Targets only\$1.70 per dozen, list price
- 12 - 12" Targets only 2.90 per dozen, list price
- 12 - 18" Targets only 4.05 per dozen, list price
- 12 - 24" Targets only 5.85 per dozen, list price

4-COLOR TARGET FACES AND FIELD SETS

By Universal Displays

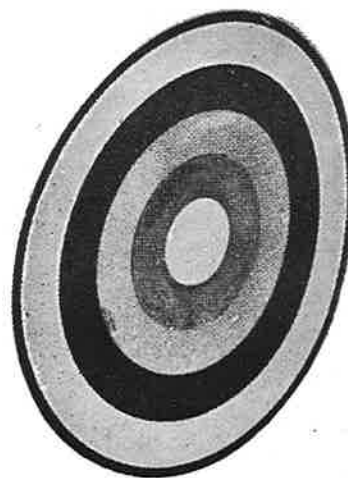

No. 4200 (Illustrated) \$5.95 per set

- No. P-48—48" Heavy bleached kraft paper \$.90
- No. P-36—36" Heavy bleached kraft paper60
- No. P-24—24" Heavy bleached kraft paper40
- No. P-16—16" Heavy bleached kraft paper15
- No. P-10—10" Heavy bleached kraft paper10
- No. 4200—Universal Broadhead Faces, 16 Faces in Set 5.95
- No. 4900—NEW! Black Hunter's Faces, 18 Faces in Set 3.65
- No. 5510—Black Roving Faces, 17 Faces in Set..... 1.95
- No. 3601—Animal Roving Faces, 36 Faces in Set 4.45
- No. 3602—Gray Roving Faces, 36 Faces in Set 2.95

— HUNTING POINTS —

"HILLS HORNET"

The Answer to a Bow Hunter's Prayer!

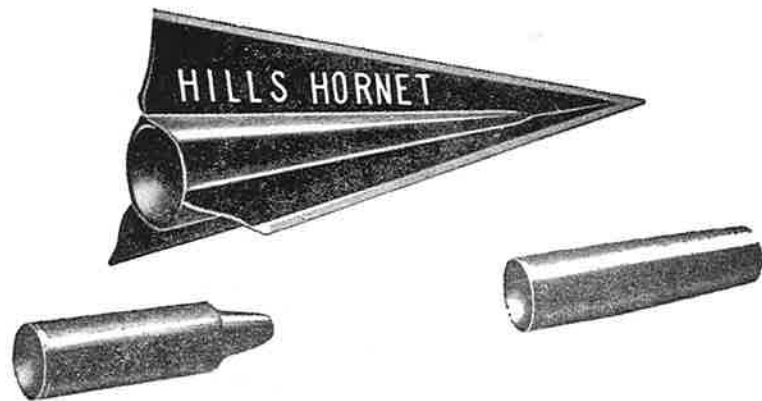

—: FOR EVERY ARCHER'S EVERY NEED :—

Field Point, \$1.40 per dozen Broadhead, \$3.75 per dozen

Concave Nose Blunt, \$1.40 per dozen

(All 3 style points have the same universal 5° taper and weight)

	(Available in 5 sizes)			
For 1/4"	9/32"	5/16"	11/32"	
85 grains	100 grains	100 grains	125 grains	

Tournament and Small Game Broadhead

9/32 - 5/16 - 11/32 — \$3.75 per dozen

Big Game Broadheads

11/32 - 160 Grains, \$4.50 dozen.

ARROW MATE 2-BLADE BROADHEAD

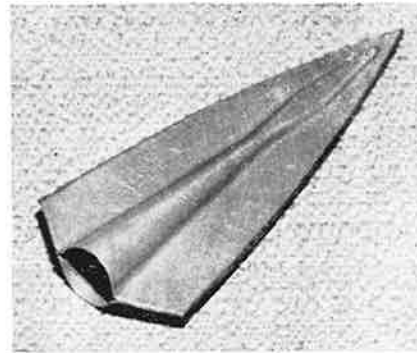

Four Sizes Available: 1/4, 9/32, 5/16, 11/32
List Price \$3.75 per dozen

HUNT WITH CONFIDENCE,
BE SURE, USE THE



M-A 3-Blade Broadhead

It's accurate, it's deadly, it's guaranteed. Three blade construction lessens wind resistance, assures truer flight. Make-All is the originator of the 3-Blade Broadhead and is so confident of its own engineering skill and of the merits of the design and construction of the M-A 3-Blade Broadhead that it guarantees this product against all defects. Compare M-A 3-Blade, welded, copper-brazed, precision balanced construction; all blades are precision ground concentric to the shaft center; note the nonglare, rust-resistant finish. M-A 3-Blade Broadheads give you more — and you'll get more game. Two sizes: 11/32 - 5/16. **\$3.75 dozen**

BOD-KIN THREE-BLADED POINT



LIGHT — STRONG — DEADLY

Test them yourself. Shoot a BOD-KIN into any material of your own choice. **They can take it!**

If you use BOD-KINS
You'll be a BETTER SHOT

\$3.75 per dozen

TWO SIZES: 5/16" (100 grains)
and 11/32" (125 grains)

BOD-KIN points are sold by most dealers. They are standard equipment on arrows made by many manufacturers. Ask for BOD-KIN points.

HIGH PRECISION

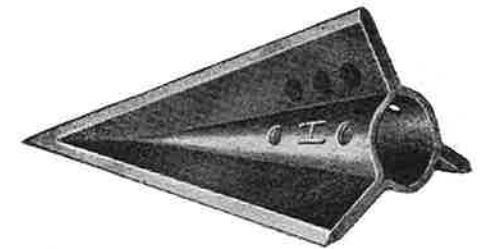

ONE-PIECE WELDED HEAD - REINFORCED SPOTS
NINE (9) FERRULE
RAZOR-SHARP PRECISION GROUND POINT AND
BLADES
FINEST OIL-HARDENING TOOL STEEL POINTS
PRECISION GROUND CONCENTRIC TO SHAFT
CENTER
EVERY "HI-PRECISION" BLUE SHEET GUN FINISH
BROADHEAD IS CAREFULLY HARDENED, TEM-
PERED AND GROUND, FOR STRENGTH, ACCUR-
ACY AND LONG LIFE.

AVAILABLE IN FOLLOWING SIZES: 5/16" (100
GRAINS), 11/32" (125 GRAINS). LIST PRICE:

List Price, \$3.75 Dozen

GET RESULTS

with the

COBRA

An Arrowhead with 6 Cutting Edges



The Cobra is "as deadly as its name" because it has the exclusive six cutting edges, which give it the largest cutting area of all, plus a spear-like, rib-reinforced point for greatest strength, and the Cobra is not only as accurate as, but pulls from a bale as easy as your field points. Tempered Spring Steel 5/8" x 7/8" x 2-3/8"

Weight 115 Grains

Price only \$3.95 doz.

Brazed From End to End

NOTICE — WHEREVER POSSIBLE, ORDER BY STOCK NUMBER.

The Deadliest Killer Ever Devised
THE HILBRE . . .

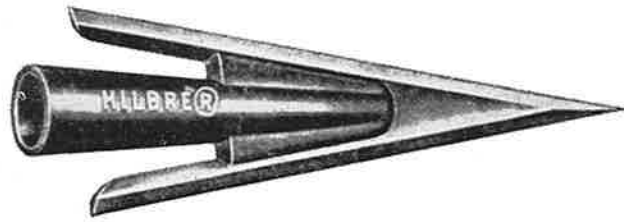

1" x 3" — 110 GRAIN **WILL NOT WINDPLANE**
THE ONLY BROADHEAD WITH RAZOR SHARP EDGES
 A BEAUTIFUL KILLER PERFECTLY ALIGNED FOR ACCURATE
 FLIGHT AND COMPLETE PENETRATION
 List Price . . . **\$4.50** Per Doz.

THE NYBRE . . .



AN INEXPENSIVE BROADHEAD FOR SMALL GAME HUNTING
 AND THE NFAA BROADHEAD ROUND
THE SOLID NYLON POINT
 List Price . . . **\$1.75** Per Doz.
 1 - 1/16" x 2 - 5/16" — 60 GRAINS
 Lightweight for speed and flat trajectory — Strong and durable
 Perfect 5° Taper

NOTICE — WHEREVER POSSIBLE, ORDER BY STOCK NUMBER.

WATER SKI ACCESSORIES

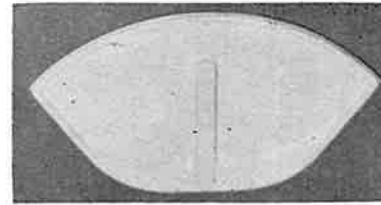

Molded Rubber Heels—HP15
 Black or White List Price **\$1.50** pair

Double Hardwood Handles—DH35
 (as illustrated) Drilled and
 Painted List Price **35c** pair

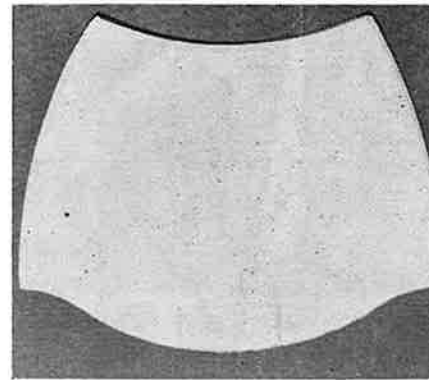
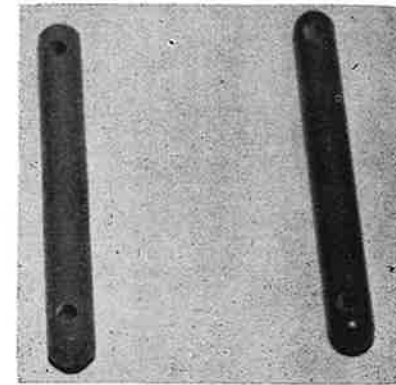

Molded Rubber Toes—TP195
 Black or White List Price **\$1.95** pair

Plastic Float—F80 (as illustrated)
 For Ski Tow Lines List Price **80c** each

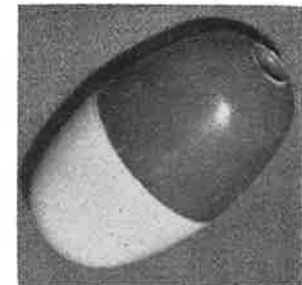

NOTICE — WHEREVER POSSIBLE, ORDER BY STOCK NUMBER.

THE BLACK HAWK "JET" WATER SKIS

by Cravotta Brothers

Something NEW in Water Skiing, new in design, new in ease, new in that feeling of swift, sure glide and ease in riding quality. New in styling, eye-appeal and sales-appeal.

Made of the finest quality, matched, kiln-dried woods and plastics. Made by mastercraftsmen with inborn pride of achievement in producing the ultimate in beauty of appearance, with the highest degree of performance.

IMPORTANT — All Black Hawk Water Skis carry a 30-day warranty—Warranty Card enclosed with all Black Hawk Water Skis, and must be filled in and returned by purchaser on date of purchase.

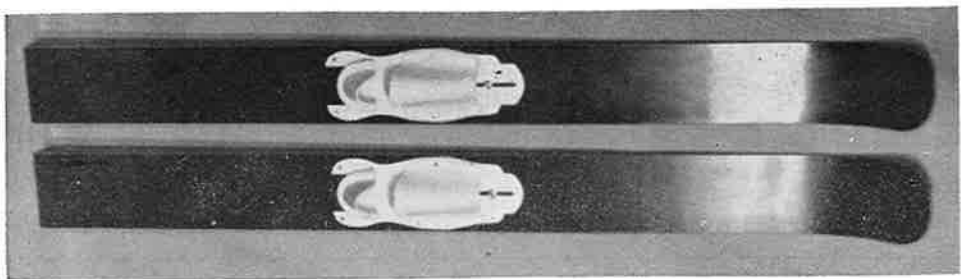

The Black Hawk Jet-1 Deluxe—BJ1D
(5 feet x 6¾ inches) List Price **\$44.95** per Pair

Top quality, precision cut laminations of the highest quality, kiln-dried lumber, laminated to beautiful waterproofed plastics; incorporating the latest in Black Hawk Binders.

This Ski is suitable for conversion to Turn-around Ski by removing the plastic Keels.

This Ski has proven to be excellent for jumping, in exhaustive tests by our company.

A many-purpose Ski, with eye-appeal, sales-appeal and use-appeal; that insures volume selling.

This Ski available in solid colors, yellow or red or wood patterns of light woods or mahogany.

☛ NOTICE — WHEREVER POSSIBLE, ORDER BY STOCK NUMBER. ☛

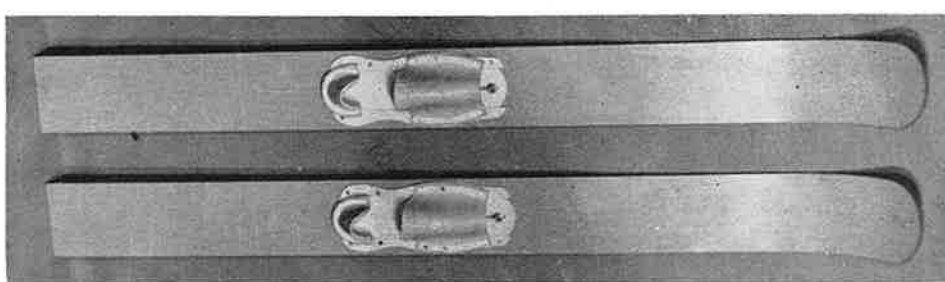

The Black Hawk Jet-2 Standard—BJ-2S
(5 feet x 6¾ inches) List Price **\$36.95** Pair

Same as Jet-1 Deluxe with exception that bottom plastic lamination is of different type plastic, enabling a top-quality Ski to sell at this fabulously low price.

This Ski available only in wood patterns; blond or mahogany.

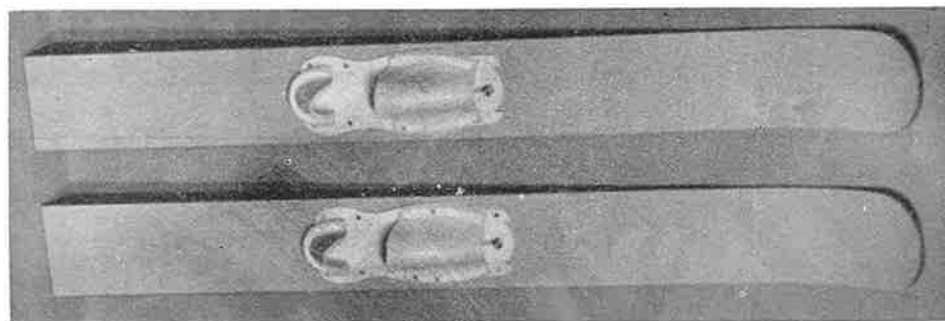

The Black Hawk Jet 1-A Deluxe—BJ-1AD
(5 feet 10 inches x 6¼ inches) List Price **\$44.95** Pair

Same as BJ-1D.

An excellent Water Ski for all water sports; enthusiastic beginners and experts alike; for jumping or rough usage, giving top performance at any skiing speed.

The Jet-1A also is fitted with the famous Black Hawk "Quick-Ease" foot Binder.

This Ski is available in solid colors, yellow or red, or in wood patterns, light or mahogany.

☛ NOTICE — WHEREVER POSSIBLE, ORDER BY STOCK NUMBER. ☛

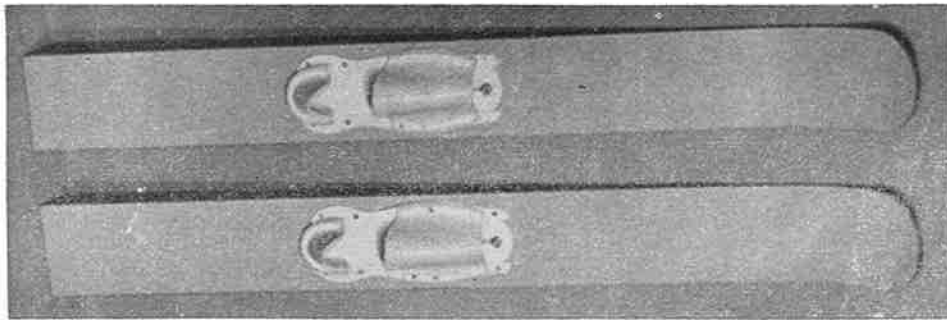

The Black Hawk Jet 2-A Standard—BJ-2AS
(5 feet 10 inches x 6¼ inches) List Price **\$36.95**

Same as Black Hawk Jet BJ-1AD, with exception that bottom plastic lamination is of different type plastic, enabling this top-quality Ski to sell at this fabulously low price.

This Ski is available only in wood patterns, light or mahogany.

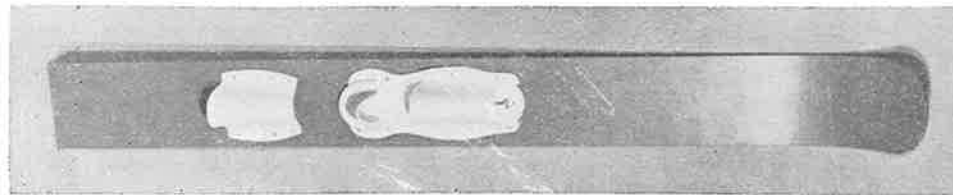

The Black Hawk Jet-3 Slalom Deluxe—BJ-3D (5'9"x7") List Price **\$27.95**

Same as Jet-1 Deluxe, except a single Ski with single Quick-Ease binder and Quick-Ease toe binder, with a special size, single, plastic keel. A top favorite of Slalom Skiers.



The Black Hawk Jet-3 Slalom Standard—BJ-3S List Price **\$23.95**

Same as the Jet-3 Slalom Deluxe except that bottom lamination is of a different type plastic.

👉 NOTICE — WHEREVER POSSIBLE, ORDER BY STOCK NUMBER. 👈

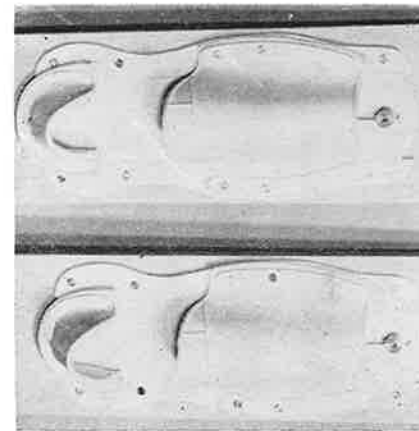

THE BLACK HAWK "QUICK-EASE"—BQE11
Water Ski Binding List Price **\$10.95 Pair**

Binding designed by experts for glove-like fitting of feet, comfort of feel, and simple, easy adjustment that will not require a portable tool-kit, and super strength for adjustment.

All Toe and Heel Pieces made of finest quality rubber; fastenings and plates made of tough, enduring plastic, impervious to injury by any of the elements.

A complete Ski Binding Set, including hardware, attractively packaged, competitively priced, unsurpassable in design and application that can be used with any make Ski, and that is simple in application for attachment to Skis.

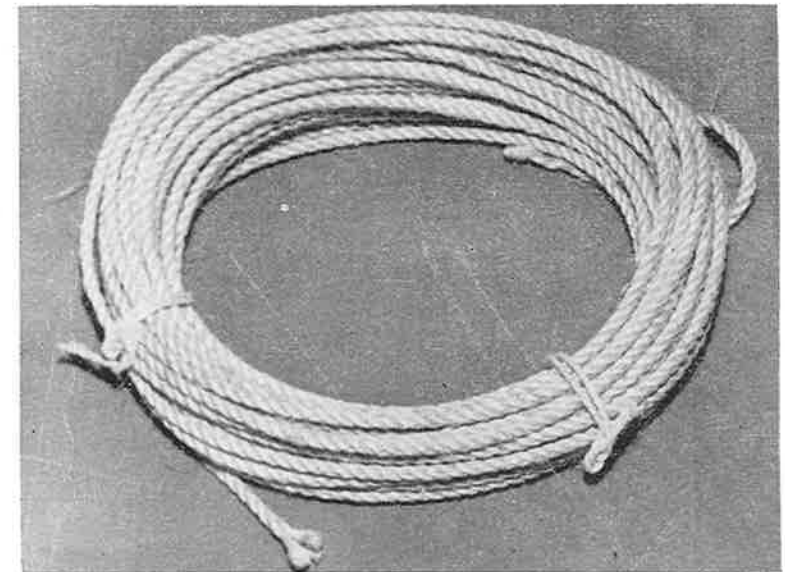

70-Foot Coil of ¼" Manila Ski Rope—MSR295

Breaking Strength 600# List Price **\$2.95**



Single Hardwood Handles—H25

Painted and Drilled for Ski Tow Lines List Price **25c** each

👉 NOTICE — WHEREVER POSSIBLE, ORDER BY STOCK NUMBER. 👈

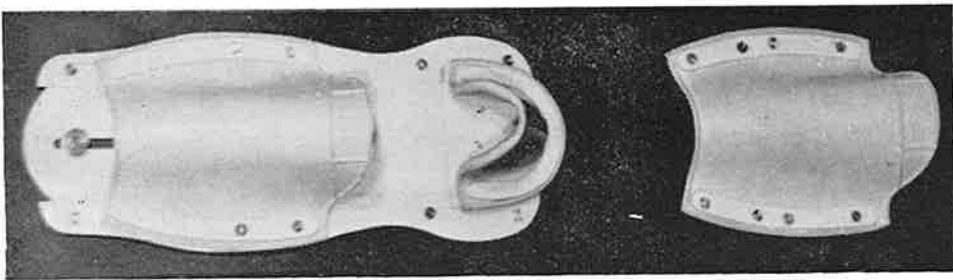

Includes one complete Quick-Ease Binder and one Quick-Ease Slalom Toe Binder, with all parts and fittings, can be used with all makes Slalom Skis.

The Black Hawk Slalom Binder—BQE-S8 List Price **\$7.95**

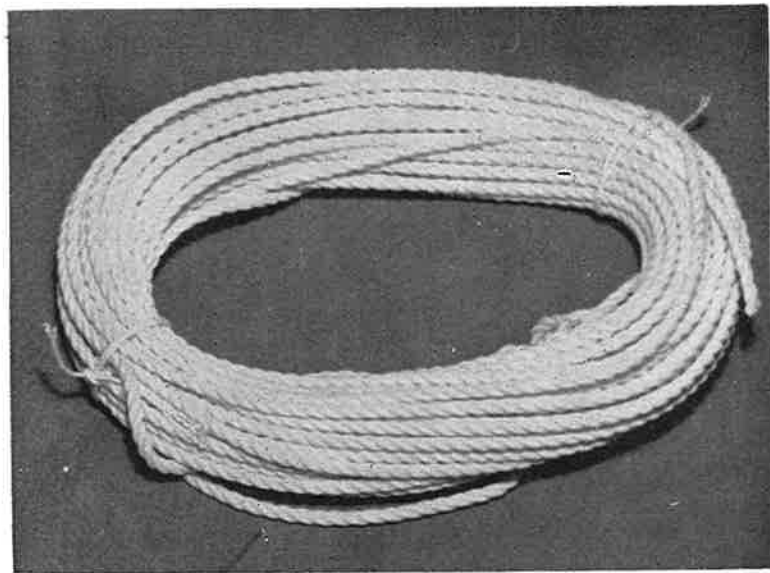

70-Foot Coil of Polyethylene Self-Floating Rope—PSR695

Breaking Strength 900# List Price **\$6.95**

👉 NOTICE — WHEREVER POSSIBLE, ORDER BY STOCK NUMBER. 👈

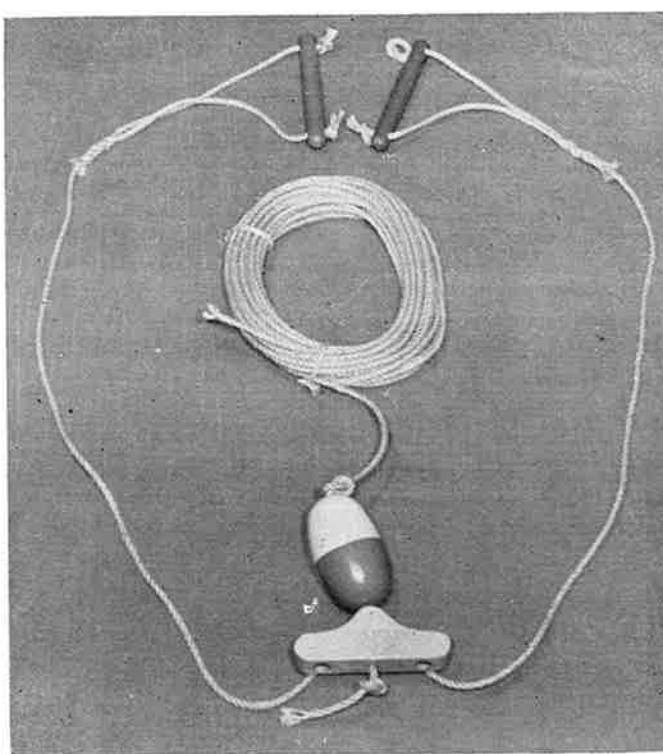

Double Handle
Tow Rope
BDH55 (Manila
same as BSH45)
List Price, **\$5.50**

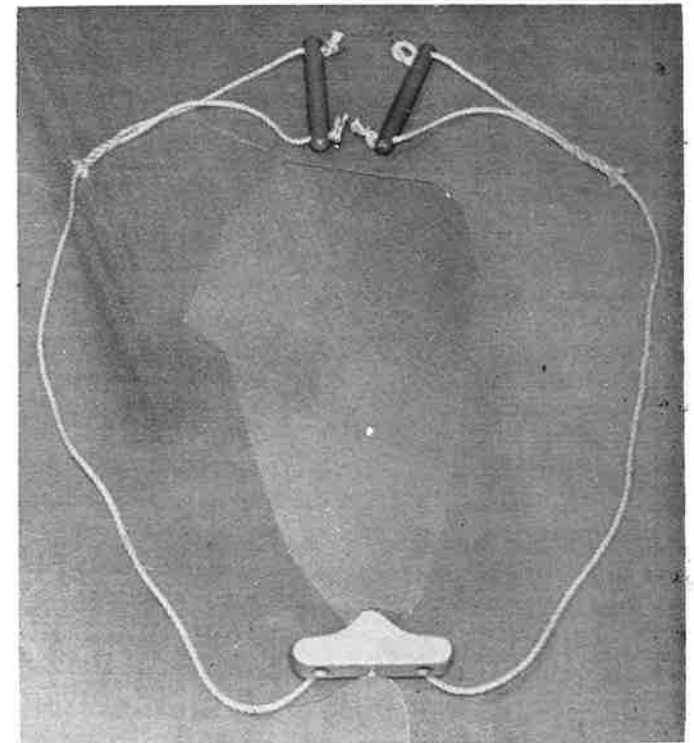

Double Handle
Bridle Manila Rope
DHB25
List Price, **\$2.50**

👉 NOTICE — WHEREVER POSSIBLE, ORDER BY STOCK NUMBER. 👈

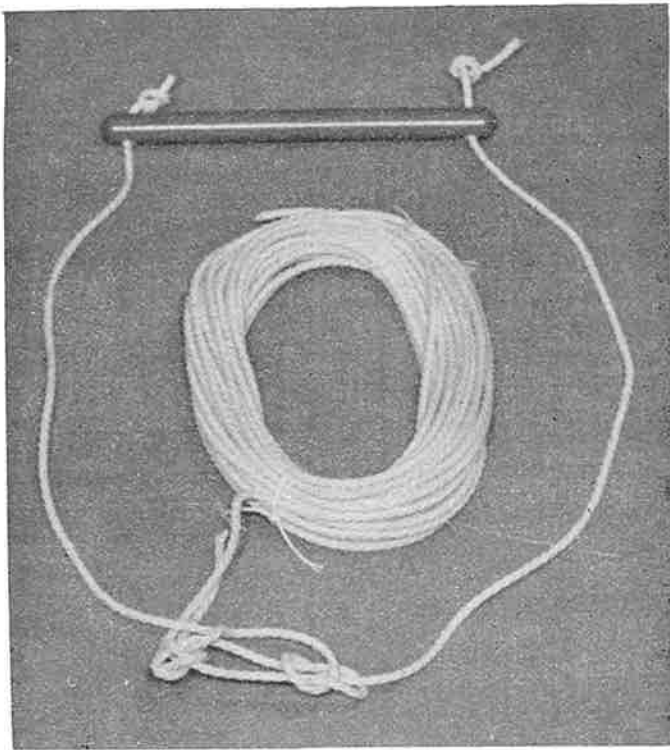

Single Handle
Tow Rope—SHP-8
Polyethylene
Self-Floating
70' Length
List Price, \$7.95

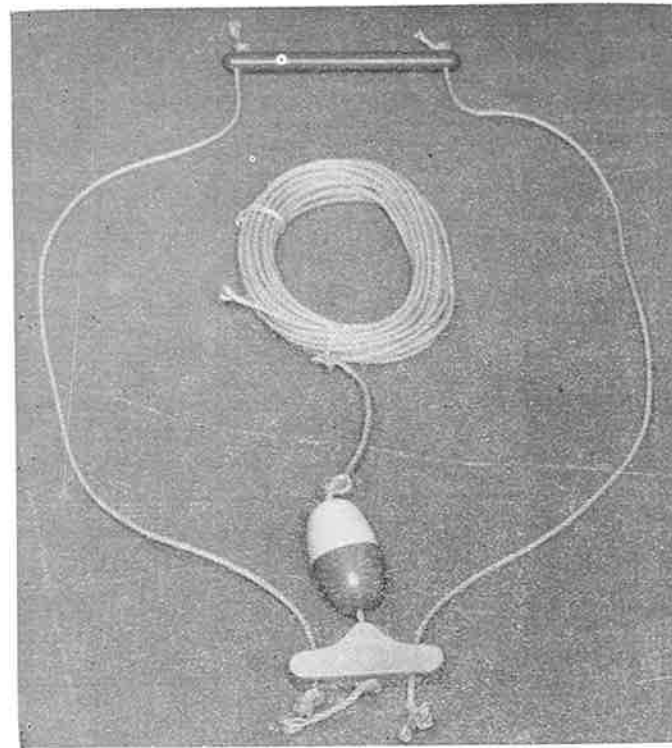

Single Handle Tow Line (as illustrated) made of finest Manila, Rot-Proofed rope, especially designed for water skiing; 1/4" thick at 600# strength; 70 lineal feet of line, complete with float and hardwood handle.
Single Handle
Tow Line—BSH45
List Price, \$4.50

Single Handle Bridle
SHBP-3
Polyethylene
List Price, \$2.95

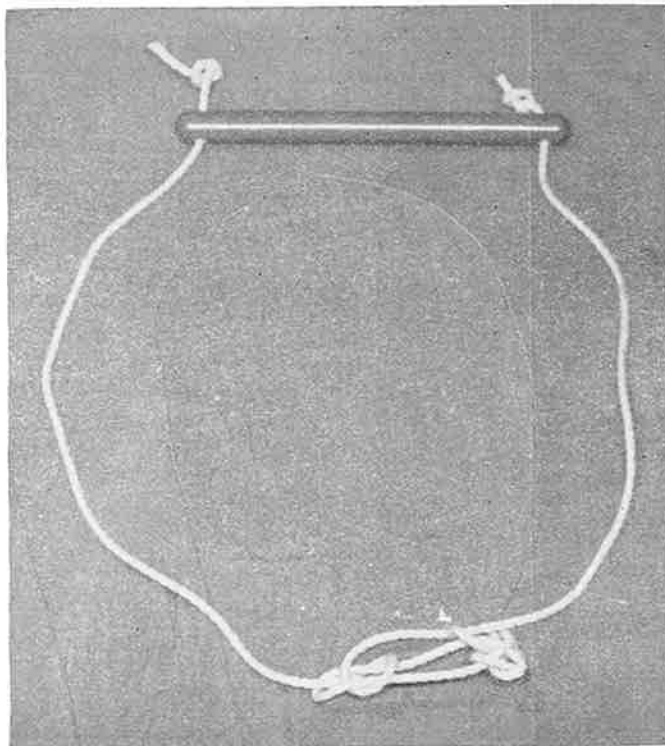

Single Handle Bridle
SHB-2, Manila Rope
(as illustrated)
List Price, \$1.95

