

Forged High Pressure Ball Valves

SBVF360 Series

Introduction

- SUPERLOK SBVF360 Series ball valves provide quick quarter turn operation in a compact design providing positive shutoff in applications up to 6,000psig (413bar).
- A selection of valve body, seat, and seal materials provide a wide range of pressures and temperatures at which the valve may be used.

Features

- High flow capacity in a compact design
- Micro - finished ball provides a positive seal
- Low operating torques
- Positive handle stops
- Panel mountable
- Handle indicates flow direction
- Each and every valve is tested at the factory



Specifications

Pressure rating	6000psig (413bar)@70°F (21°C) with standard PCTFE seat
Temperature rating	-65 to 350 °F (-54 to 177°C) with standard PCTFE seat
Body material	316 stainless steel and brass
Body configurations	Two - way and Three - way
Port connections	1/16" to 3/4" and 4mm to 16mm Variety of end connection.

Testing

- Each Valve is tested with nitrogen at 1000psig (69bar) to maximum allowable leak rate of 0.1 SCCM.
- Hydrostatic shell test is performed at 1.5 times of the working pressure. (OPTION)

Materials of Construction

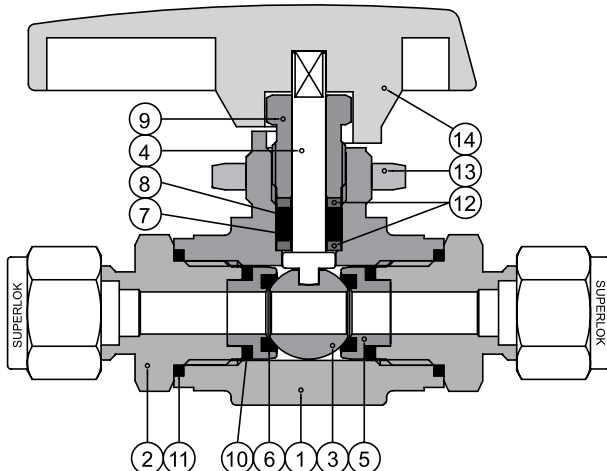

Component	Material Grade / ASTM Specification	
	Stainless Steel	Brass
*1 Body	SS316 / A182	Brass / B283
*2 End Connector	SS316 / A479	Brass / B16
*3 Ball	SS316 / A276	
*4 Stem	SS316 / A479	
*5 Seal Retainer	SS316 / A479	
*6 Ball Seal	Standard PCTFE (PTFE,PEEK)	
*7 Lower Packing	PTFE	
*8 Upper Packing	PTFE	
9 Packing Bolt	SS316 / A479	
*10 Retainer Back up Seal	PTFE	
*11 Connector Seal	PTFE	
*12 Stem Washer	SS316 / A276	
13 Panel Nut	SS316 / A276	
14 Handle	Aluminum	

* Wetted components

Two - way SBVF360 Series

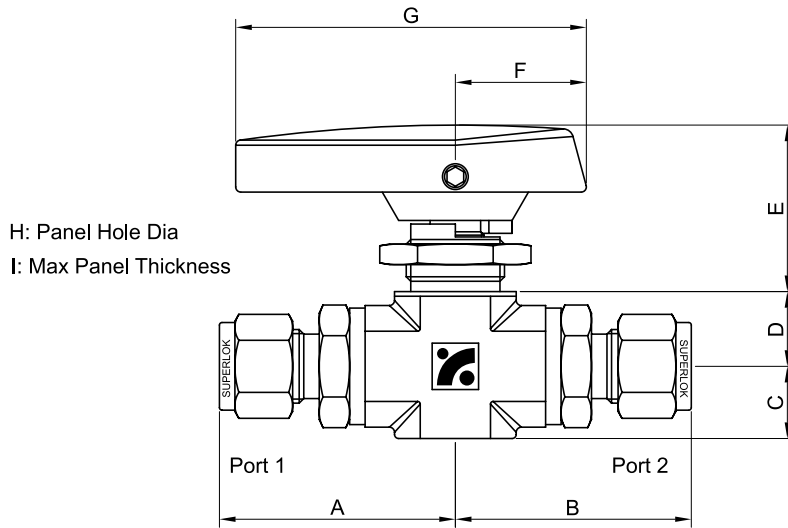

Table of dimensions

Order Number		Orifice Inch(mm)	Cv	End Connections Port1 / Port2	Dimensions Inch(mm)								
Series	Part No.				A	B	C	D	E	F	G	H	I
SBVF 3601	S-2	0.165(4.2)	0.93	1/8" SUPERLOK	1.36 (34.5)	1.36 (34.5)	0.39 (10.0)	0.41 (10.5)	0.93 (23.5)	0.71 (18.0)	1.85 (47.0)	0.64 (16.3)	0.13 (3.3)
	F-2N			1/8" FEMALE NPT	1.07 (27.2)	1.07 (27.2)							
	M-2N			1/8" MALE NPT	1.18 (29.9)	1.18 (29.9)							
	S-4			1/4" SUPERLOK	1.48 (37.6)	1.48 (37.6)							
	M-4N			1/4" MALE NPT	1.35 (34.3)	1.35 (34.3)							
	S-3M	0.086(2.2)	0.18	3mm SUPERLOK	1.37 (34.8)	1.37 (34.8)							
SBVF 3602	S-4	0.250(6.4)	2.34	1/4" SUPERLOK	1.74 (44.2)	1.74 (44.2)	0.55 (14.0)	0.57 (14.5)	1.27 (32.3)	1.0 (25.4)	2.68 (68.0)	0.77 (19.6)	0.25 (6.4)
	F-4N			1/4" FEMALE NPT	1.51 (38.4)	1.51 (38.4)							
	M-4N			1/4" MALE NPT	1.62 (41.1)	1.62 (41.1)							
	S-6			3/8" SUPERLOK	1.80 (45.7)	1.80 (45.7)							
	M-6N	3/8" MALE NPT	1.62 (41.1)	1.62 (41.1)									
	S-6M	0.189(4.8)	1.04	6mm SUPERLOK	1.75 (44.5)	1.75 (44.5)							
	S-8M	0.250(6.4)	2.34	8mm SUPERLOK	1.78 (45.2)	1.78 (45.2)							
	S-10M			10mm SUPERLOK	1.81 (46.0)	1.81 (46.0)							
SBVF 3603	F-6N	0.406(10.3)	6.42	3/8" FEMALE NPT	1.95 (49.5)	1.95 (49.5)	0.69 (17.5)	0.76 (19.3)	1.62 (41.1)	1.09 (27.7)	2.92 (74.2)	0.90 (22.9)	0.38 (9.7)
	F-8N			1/2" FEMALE NPT	2.15 (54.6)	2.15 (54.6)							
	S-8			1/2" SUPERLOK	2.34 (59.4)	2.34 (59.4)							
	M-8N			1/2" MALE NPT	2.22 (56.4)	2.22 (56.4)							
	S-12			3/4" SUPERLOK	2.33 (59.2)	2.33 (59.2)							
	S-12M	0.375(9.5)	5.57	12mm SUPERLOK	2.33 (59.2)	2.33 (59.2)							
	S-16M	0.406(10.3)	6.42	16mm SUPERLOK	2.33 (59.2)	2.33 (59.2)							

* Dimensions based on SUPERLOK nuts finger-tight. Dimensions are reference only, subject to change.

Three - way SBVF360 Series

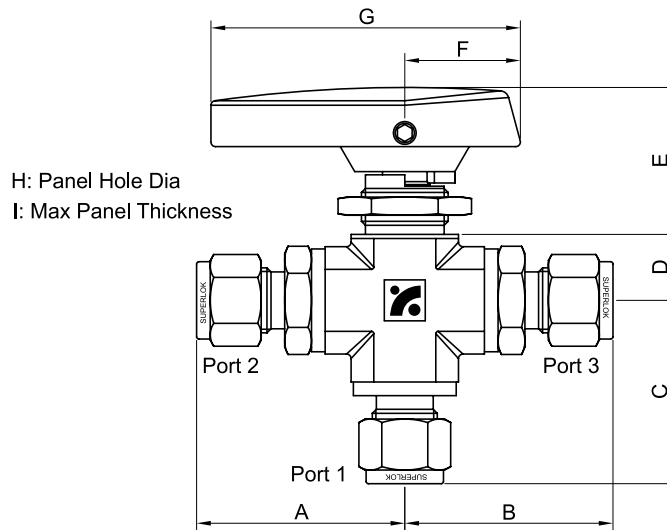

Table of dimensions

Order Number		Orifice Inch(mm)	Cv	End Connections Port1 / Port2 / Port3	Dimensions Inch(mm)								
Series	Part No.				A	B	C	D	E	F	G	H	I
SBVF 3601-3B	S-2	0.165(4.2)	0.21	1/8" SUPERLOK	1.36 (34.5)	1.36 (34.5)	1.43 (36.4)	0.41 (10.5)	0.93 (23.5)	0.71 (18.0)	1.85 (47.0)	0.64 (16.3)	0.13 (3.3)
	F-2N			1/8" FEMALE NPT	1.07 (27.2)	1.07 (27.2)	1.18 (29.9)						
	M-2N			1/8" MALE NPT	1.18 (29.9)	1.18 (29.9)	1.18 (29.9)						
	S-4			1/4" SUPERLOK	1.48 (37.6)	1.48 (37.6)	1.46 (37.2)						
	M-4N			1/4" MALE NPT	1.35 (34.3)	1.35 (34.3)	1.18 (29.9)						
	S-3M	3mm SUPERLOK	1.37 (34.8)	1.37 (34.8)	1.43 (36.4)								
SBVF 3602-3B	S-4	0.250(6.4)	0.70	1/4" SUPERLOK	1.74 (44.2)	1.74 (44.2)	1.59 (40.3)	0.57 (14.5)	1.27 (32.3)	1.0 (25.4)	2.68 (68.0)	0.77 (19.6)	0.25 (6.4)
	F-4N			1/4" FEMALE NPT	1.51 (38.4)	1.51 (38.4)	1.30 (33.0)						
	M-4N			1/4" MALE NPT	1.62 (41.1)	1.62 (41.1)	1.30 (33.0)						
	S-6			3/8" SUPERLOK	1.80 (45.7)	1.80 (45.7)	1.59 (40.3)						
	M-6N	3/8" MALE NPT	1.62 (41.1)	1.62 (41.1)	1.30 (33.0)								
	S-6M	6mm SUPERLOK	1.75 (44.5)	1.75 (44.5)	1.59 (40.4)								
	S-8M	8mm SUPERLOK	1.78 (45.2)	1.78 (45.2)	1.59 (40.4)								
	S-10M	10mm SUPERLOK	1.81 (46.0)	1.81 (46.0)	1.60 (40.6)								
SBVF 3603-3B	F-6N	0.406(10.3)	3.62	3/8" FEMALE NPT	1.95 (49.5)	1.95 (49.5)	1.85 (47.0)	0.76 (19.3)	1.62 (41.1)	1.09 (27.7)	2.92 (74.2)	0.90 (22.9)	0.38 (9.7)
	F-8N			1/2" FEMALE NPT	2.15 (54.6)	2.15 (54.6)	1.85 (47.0)						
	S-8			1/2" SUPERLOK	2.34 (59.4)	2.34 (59.4)	2.25 (57.1)						
	M-8N			1/2" MALE NPT	2.22 (56.4)	2.22 (56.4)	1.85 (47.0)						
	S-12			3/4" SUPERLOK	2.33 (59.2)	2.33 (59.2)	2.25 (57.1)						
	S-12M	12mm SUPERLOK	2.33 (59.2)	2.33 (59.2)	2.25 (57.1)								
	S-16M	16mm SUPERLOK	2.33 (59.2)	2.33 (59.2)	2.25 (57.1)								

* Dimensions based on SUPERLOK nuts finger-tight. Dimensions are reference only, subject to change.

Technical Data

Seats and Body Materials vs Temperature and Pressure Rating

Seat Material	Temperature Rating	Pressure Rating @ 100°F (38°C)		Pressure Rating @ Max. Temperature	
		Stainless Steel	Brass	Stainless Steel	Brass
PCTFE	-65 to 300°F (-54 to 148°C)	6000psig (413bar)	3000psig (207bar)	1000psig @300°F (68.9bar @148°C)	700psig @300°F
PEEK	-65 to 450°F (-54 to 232°C)	6000psig (413bar)	3000psig (207bar)	700psig @400°F (48bar @200°C)	(48bar @200°C)
PTFE	-65 to 300°F (-54 to 148°C)	1500psig (103bar)	1500psig (103bar)	250psig @300 °F (17.2bar @148°C)	

Flow Rate with 1000psig (69bar) Inlet Pressure

Two - Way

Cv	Pressure Drop ΔP(psig)					
	Water @60°F (16°C) scfm			Air @60°F (16°C) gpm		
	10	50	100	10	50	100
0.06	0.2	0.4	0.6	5.9	13.2	18.7
0.18	0.6	1.3	1.8	17.7	39.6	56.0
0.21	0.7	1.5	2.1	20.7	46.2	65.4
0.93	2.9	6.6	9.3	91.5	204.7	289.5
1.04	3.3	7.4	10.4	102.4	228.9	323.7
2.34	7.4	16.5	23.4	230.3	515.0	728.3
5.57	17.6	39.4	55.7	548.2	1225.9	1733.7
6.42	20.3	45.4	64.2	631.9	1413.0	1998.3

* To determine m³ / hr, multiply GPM by 0.227 and SCFM by 1.69

Three - Way

Cv	Pressure Drop ΔP(psig)					
	Water @60°F (16°C) scfm			Air @60°F (16°C) gpm		
	10	50	100	10	50	100
0.06	0.2	0.4	0.6	5.9	13.2	18.7
0.18	0.6	1.3	1.8	17.7	39.6	56.0
0.21	0.7	1.5	2.1	20.7	46.2	65.4
0.63	2.0	4.5	6.3	62.0	138.7	196.1
0.70	2.2	4.9	7.0	68.9	154.1	217.9
0.87	2.8	6.2	8.7	85.6	191.5	270.8
3.46	10.9	24.5	34.6	340.6	761.5	1077.0
3.62	11.4	25.6	36.2	356.3	796.7	1126.8

* To determine m³ / hr, multiply GPM by 0.227 and SCFM by 1.69

Ordering Information

SBVF3602 - MS - 6N - 6 - PT - SS

1
2
3
4
5

1. Valve Series

- Two - Way
- SBVF3601
- SBVF3602
- SBVF3603
- Three - Way
- SBVF3601 - 3B
- SBVF3602 - 3B
- SBVF3603 - 3B

2. Port Type

- Two - Way
- : Port 1 x Port 2
- S : SUPERLOK Tube Fitting
- M : Male Thread
- F : Female Thread
- Three - Way
- : Port 1 x Port 2 x Port 3

3. Port Size

- Two - Way
- : Port 1 x Port 2
- Three - Way
- : Port 1 x Port 2 x Port 3

- Pipe Thread Designation

Size (inch)	1/8	1/4	3/8	1/2	3/4
Screwed BSPT	2R	4R	6R	8R	12R
Screwed NPT	2N	4N	6N	8N	12N

- Tube O.D Designation

Tube O.D (inch)	1/16	1/8	1/4	3/8	1/2	3/4
Designation	1	2	4	6	8	12
Tube O.D (mm)	3	6	8	10	12	16
Designation	3M	6M	8M	10M	12M	16M

4. Seat Material

- PC : PCTFE
- PE : PEEK
- PT : PTFE

5. Body Material

- SS : 316 Stainless Steel
- B : Brass

■ Examples

- ex1) SBVF3602 - S - 6 - PC - B
 - SBVF3602 : 2-Way / [Port1]SUPERLOK x [Port2]SUPERLOK / Port Size : 3/8" x 3/8"
 Seat Material : PCTFE / Body Material : Brass
- ex2) SBVF3602 - 3B - S - 6 - PC - SS
 - SBVF3602-3B : 3-Way / [Port1&2&3]SUPERLOK / Port Size : [Port1&2&3]3/8"
 Seat Material : PCTFE / Body Material : 316 Stainless Steel
- ex3) SBVF3602 - 3B - FSS - 4N - 6 - 6 - PC - SS
 - SBVF3602-3B : 3-Way / [Port1]Female Thread x [Port2&3]SUPERLOK / Port Size : [Port1]1/4"NPT x [Port2&3]3/8"
 Seat Material : PCTFE / Body Material : 316 Stainless Steel