



Monroe Fire Protection District



Board of Trustees

Meeting Agenda

December 13, 2023

Meeting held at Station 25,
5081 N. Old State Road 37 and via
ZOOM

at 6:00 PM EST

Meeting Link: <https://us02web.zoom.us/j/2509924795>

Vicky Sorensen
Chair

Mark Kruzan
Vice-Chair

Michael Baker
Board Trustee

Christina Courtright
Board Trustee

Kevin R. Robling
Board Trustee

Daniel Vest
Board Trustee

- 1. Call to Order and Roll Call**
- 2. Changes or Amendments to Agenda**
- 3. Public Comment**
- 4. Approval of Minutes – November 8, 2023 meeting minutes**
- 5. Unfinished Business**
 - a. Annual Items for Review
 - b. Personnel Handbook
 - c. Salary Ordinance 001-23
 - d. 2024 Meeting Schedule
- 6. Department Updates**
 - a. Legal Counsel – Attorney, Christine Bartlett
 - b. Statistics – Deputy Chief, Matt Bright
 - c. Special Operations and EMS – Deputy Chief, Matt Bright
 - d. Operations – Deputy Chief, George Cornwell
 - e. Training – Assistant Chief, Tim Deckard
 - f. Community Risk Reduction – Assistant Chief, Jeffrey Combs
 - g. Administrative – Chief, Dustin Dillard
- 7. New Business**
 - a. Year End Transfers & Encumbrances
 - b. Rainy Day Fund Transfer
 - c. Year End Purchases
- 8. Financials**
 - a. Financial – Claims
 - b. Financial – Payroll
 - c. Financial – Statement
- 9. Next Meeting Scheduled January 10, 2024 @ Station 21, 9094 S. Strain Ridge Road and via Zoom**
- 10. Adjourn**



Monroe Fire Protection District



MINUTES OF MEETING OF THE BOARD OF TRUSTEES

Chair Sorensen called the meeting of the Board of Trustees of the Monroe Fire Protection District to order at 6:02p.m. EST Wednesday, November 8, 2023. The meeting was held in person at Station 21, located at 9094 S. Strain Ridge Road, Bloomington Indiana and via Zoom for public to view. Public notice of the meeting had been duly made to local media by email transmission and hard copy notices had been placed in all the usual places.

Mrs. Bovenschen called the roll of the board of trustees to determine members present, absent, and to identify others present via Zoom.

Present in person were as follows: Vicky Sorensen, Chair
Mark Kruzan, Vice-Chair (via Zoom 6:05pm)
Michael Baker, Fiscal Officer
Christina Courtright, Trustee
Dan Vest, Trustee

Those absent were as follows: Kevin R. Robling, Trustee

Others present were as follows: Dustin Dillard, Chief
George Cornwell, Deputy Chief, Operations
Matt Bright, Deputy Chief, EMS
Steve Coover, Deputy Chief, Community Risk Reduction
Jeffrey Combs, Assistant Chief of Administration
Tim Deckard, Assistant Chief of Training
Christine Bartlett, Attorney, Ferguson Law
Tammy Bovenschen, Administrative Assistant
Lorie Robinson, Financial Assistant
Darrell Cooper, IT Specialist
Dave Burnworth, community member (via Zoom)

**HEADQUARTERS
3953 S KENNEDY DRIVE
BLOOMINGTON IN
812-331-1906
812-336-1166 (FAX)**

CHANGES OR AMENDMENTS TO THE AGENDA

Chair Sorensen asked if there were any changes or amendments to the agenda. Mrs. Bovenschen reported no changes to the agenda.

PUBLIC COMMENT

Chair Sorensen explained this was the time when any member of the public could speak to the board concerning any matter not listed on the agenda. There was no public comment.

MINUTES OF PREVIOUS MEETING

Minutes from the October 11 regular meeting were presented to the board for approval.

Trustee Vest made a motion to approve the minutes of October 11, 2023.

Trustee Courtright 2nd

Motion passed 4-0

UNFINISHED BUSINESS

DEPARTMENT UPDATES

Department Updates

a. Legal Updates

Legal Counsel, Christine Bartlett had nothing to update.

b. Statistics

	<u>Sept 2023</u>	<u>Oct 2023</u>
TOTAL Emergency Calls	341	372
Fire Calls	26	17
<i>Structure</i>	6	2
<i>Vehicle</i>	7	5
<i>Wildland</i>	6	7
<i>Other</i>	7	3
Over Pressure Rupture, Explosion, Overheat	1	0
EMS Calls	206	217
<i>Medical</i>	125	134
<i>EMS Crew Assist</i>	55	56
<i>Motor Vehicle Accidents</i>	26	27
Hazardous Conditions	8	29
Service Calls	35	49
Good Intent Calls	34	40
False Alarms	28	19
Severe Weather	0	0
Special Incidents	3	1
Incidents by Township	297	328
Benton	15	19
Bloomington	23	29
Clear Creek	22	29
Indian Creek	14	9

Perry	82	89
Van Buren	130	137
Washington	11	16
Incidents – Contracted Townships	17	25
Polk	5	7
Salt Creek	12	18
Incidents by Aid Given	27	19
Bean Blossom	1	0
Bloomington City	2	4
Ellettsville	8	0
Richland Township (EFD)	10	12
Greene County	6	3
Lawrence County	0	0
Brown County	0	0
Owen County	0	0
Morgan County	0	0
EFD AID Received - October (no MFD response)		44
AID Received - Year to Date		123

Average Response (dispatch to arrival on scene)	7 min 29 sec	7 min 25 sec
Average Turnout (dispatch to enroute)	1 min 04 sec	1 min 02 sec
Average Time on Scene	32 min 07 sec	26 min 52 sec

SOR (Statements of Refusal) signed: 2

c. Emergency Medical Services – Special Operations

Deputy Chief Bright updated the board on EMS/Special Operations

Current Situation:

- Working on Brush/EMS Squad combination

Accomplishments:

- Received a grant through LEPC for HazMat IQ Class

Planned Activities:

- Follow up meeting with IU Life Line

Deputy Chief Bright explained the grant through LEPC will allow us to hold a three-day class next spring where are personnel can be trained on the do and don'ts of HazMat. The three-day class is almost \$18,000.

Deputy Chief Bright shared with the board photos of the ambulance boxes painted and in process. There is still no current date on arrival.

d. Operations

Deputy Chief Cornwell updated the board on Operations

Current Situation:

- Rescue 21 currently out with a hydraulic oil leak
- Finishing up hydrostat testing of SCBA bottles

Accomplishments:

- Work Performance Evaluations (WPE) completed by all operations personnel
- Work Orders completed 18, Minor 10, Moderate 6 and Major 2

Planned Activities:

- Complete hydrostat testing (one station remaining – Station 22)

e. Training

Assistant Chief Deckard updated the board on Training:

Current Situation:

- Currently working on building the 2024 training calendar
- Finishing FF I/II class with Ellettsville

Accomplishments:

- Total Training hours for October: 2,100.66
 - Full Time Personnel: 1,659.25
 - Part Time Personnel: 391.91
 - Volunteer/Substitutes: 49.50

Planned Activities:

- Fall facilities training on the training grounds for all MFD shifts

Chair Sorensen asked what does training on cold weather emergencies consist of. Assistant Chief Deckard explained that yes, we have cold weather emergency training, hunter safety training, and various ice trainings.

f. Community Risk Reduction

Deputy Chief Coover updated the board on Community Risk Reduction.

Current Situation:

- Arson case preparation with prosecutor – this has been rescheduled until January and involves the fire on Terrace Drive

Accomplishments:

- Visited 27 schools/preschools for fire safety presentations and activities during the month of October, making 8,583 contacts with individuals in one month.
- Completed
 - 38 inspections
 - 57 re-inspections
 - Nine new construction inspections
 - Four plan reviews
 - Added 32 new occupancies

Planned Activities:

- Initiate the potential for CISM team from mental health providers to assist with fire department members' well being

Deputy Chief Coover was asked about the four referrals to adult protective services. He explained that we have to report similar to DCS any incidents with adults where services may be needed. Not everyone is willing to accept the assistance.

g. Administrative Report

Chief Dillard updated the board on Administrative activities:

Current Activities:

- Received PERF pre-entry medical and psychiatric physicals back from Public Safety Medical on three full-time candidates

Accomplishments:

- Leyton Craig, MFD firefighter was awarded the Firefighter of the Year for Monroe County from the Northside Exchange Club

Planned Activities:

- Finalize meeting of the INPRS 1977 Police and Fire Fund local pension board for November to discuss updating bylaws and scheduling meetings
- Open Enrollment for health insurance planned for November 16- November 30

Personnel Report:

- Hiring – 0
- Resignations – 0

Assistant Chief Combs explained the Garage door traffic control devices that are being installed in the firehouses. This traffic control device will allow the chauffeur to see if the garage door has fully opened prior to pulling out of the garage. If there would be a malfunction with the door and it did not open fully, a red light would be shown so that the chauffeur would know not to drive forward. Once a green light is shown, the vehicle may proceed.

Chief Dillard explained that our bank account had been compromised again by someone taking checks from the blue mailbox outside of the downtown post office. Chief Dillard explained that we have filed a police report and they have contacted the US Postal Inspector who is also investigating. Chair, Vice-Chair and Fiscal Officer had to sign some documents at the bank to have our account reimbursed by FDIC insurance for any funds that were taken. We are continuing to look at ways to reduce mailing checks and will now always take checks inside the post office and hand to an employee.

Chief Dillard and Assistant Chief Combs met with volunteer association concerning the next steps for the organization. After speaking with the group, we have decided that any new volunteers will be onboarded like all employees and they will have the support role of helping with fire prevention, activities and events for the District instead of having the role of emergency services. Chief

Dillard stated that the contract for 2024 will not have the same amount of funding as in previous years.

Chair Sorensen asked what renew Sam.gov is referring to? Chief Dillard explained that it is the clearing house to maintain all federal grants.

Trustee Vest asked what volunteers receive from the District, Chief Dillard explained that if they are firefighters, they are issued an entire set of gear (coat, pants, flashover hood, helmet). EMT only do not receive PPE gear. Trustee Vest asked if they are a time frame that a volunteer is inactive before they have to return their items? Chief Dillard explained that yes, if they are inactive for 90 days, they are put on notice and must return all PPE. Chief Dillard did explain that we will send letters and will follow up with police if someone doesn't return the items.

Chief Dillard explained that some of the issues with Station 26 have been the fact that we were not the original holders of any of the permits. Originally, we had thought doing two bids for the project would be best, however at this time, Chief Dillard feels that it would be best to probably bid as one total project. Chief Dillard stated that although lumber costs have gone down, the cost of concrete and metal have gone up. Chief Dillard stated that the site work has been resubmitted to the State. Legal Counsel is working on the septic permit.

NEW BUSINESS

a. Thermal Camera Purchase

Deputy Chief Cornwell explained that we would like to purchase one additional FLIR K45 thermal imaging camera. Darley & Company provided the best price at \$3,643.00 which includes the truck charger for the FLIR. We will then only have one thermal imaging camera that is not a FLIR, and it will be placed into the training program.

Trustee Vest made a motion to approve the purchase of the FLIR thermal imaging camera from Darley in the amount of \$3,643.00

Trustee Courtright 2nd

Roll Call Vote Taken

Baker – Yes, Sorensen – Yes, Kruzan – Yes, Courtright – Yes, Vest – Yes

Motion passed 5-0

b. Rope Rescue Equipment Purchase

Chief Dillard explained that the rope committee has provided a list of approximately \$26,000 worth of rope equipment they would like to purchase. Chief Dillard stated that this is a working document. A current list of exact needs was not available at the time of the meeting; however Chief Dillard would like to request up to \$10,000 to upgrade the equipment.

Chief Dillard pulled up a google document showing all of the items requested, however it is not prioritized. After reviewing the list, Trustee Courtright stated that we have approved some of this equipment previously. Deputy Chief Bright explained that this document has been compiled over the past two years, and some items have been purchased.

Fiscal Officer Baker made a motion to approve \$10,000 based on the prioritized list from Chief Dillard for rope rescue equipment.

Trustee Courtright 2nd

Roll call vote was taken

Kruzan – Yes, Baker – Yes, Sorensen – Yes, Vest – Yes, Courtright – Yes

Motion passed 5-0

c. Gear Purchase

Chief Dillard explained that we currently need 17.5 sets of gear, but are requesting for a total of 18 sets of gear in the amount of \$70,974.00

There was a question as to why we only have one quote, and Deputy Chief Cornwell explained that 911 is the only distributor for the specific gear we currently use.

Gear takes approximately six to eight weeks to receive.

Trustee Vest made a motion to approve the purchase gear in the amount of \$70,974.00

Trustee Courtright 2nd

Roll call vote was taken

Vest – Yes, Baker – Yes, Kruzan – Yes, Courtright – Yes, Sorensen – Yes

Motion passed 5-0

d. Annual Items for Review

Chief Dillard explained to the board that several of the documents must be reviewed by them each year, even if no changes are needed. The board were presented with the 2024 meeting schedule, Risk Management Policy, 2024 Salary Ordinance, MFD Firefighter Handbook and MFD Bylaws.

Administrative Assistant Bovenschen explained that she has presented two options for the 2024 meeting schedule with the October meeting being held at the budget adoption hearing with the County.

Chief Dillard went over several of the items for review. The 2024 Salary Ordinance changes include position increases, salary increases, certified salary increase, LOSAP, payment in lieu of life insurance, ride-out pay for new position (engineer). Financial Assistant Robinson stated that the Risk Management Policy still appears to be in good working order. The MFD Bylaws must be reviewed annually, legal counsel stated that there were no changes to the law. Counsel Bartlett stated that the only change that had been discussed was that the Fiscal Officer could be an employee of the District and didn't have to be a member of the Board of Trustees.

Assistant Chief Combs went over the changes for the personnel handbook; overtime submissions, sick time call in's, requiring a Dr. statement for calling in sick within 24 hours of a shift, minimum staffing requirements in two-person houses, country records retention schedule – this must be updated and included in the personnel handbook.

FINANCIALS

a. Financial – Claims

Financial Assistant Robinson presented claims signed October 2, 12, 19 and 30, 2023. Financial Assistant Robinson explained that the accountant will now print us labels for mailing.

Fiscal Officer Baker made a motion to approve claims for October 2023 as presented.
Trustee Courtright 2nd
Motion passed 4-0

b. Payroll

Included the semi-monthly payrolls for October 2023.

Trustee Courtright made a motion to approve the payrolls for October 2023 as presented.
Fiscal Officer Baker 2nd
Motion passed 4-0

c. Financial – Statement

Financial Assistant Robinson stated that the budget can be spent by 83% for this time of the year, currently we have spent 69.9% for the General Fund and 53% for the Cumulative Fund.

Financial Assistant Robinson explained that we will have encumbrances at the December meeting.

Trustee Courtright made a motion to approve the Certified Financial Statement as presented for October 31, 2023.
Trustee Vest 2nd
Motion passed 4-0

ADDITIONAL COMMENTS

NEXT MEETING

Chair Sorensen stated that the next meeting will be in person on December 13, at Station 25, located at 5081 N. Old State Road 37, Bloomington, IN. The meeting will also be held via zoom.

ADJOURN

Chair Sorensen called for a motion to adjourn.

Trustee Vest made a motion to adjourn at 7:25pm
Motion passed 4-0

Minutes approved by the board of trustees on December 13, 2023:

Aye:

Vicky Sorensen, Chair

Mark, Kruzan, Vice-Chair

Michael Baker, Fiscal Officer

Christina Courtright, Trustee

Kevin R. Robling, Trustee

Dan Vest, Trustee

Nye:

Vicky Sorensen, Chair

Mark Kruzan, Vice-Chair

Michael Baker, Fiscal Officer

Christina Courtright, Trustee

Kevin R. Robling, Trustee

Dan Vest, Trustee

Copy furnished:

Mrs. Vicky Sorensen, Chair
Mr. Michael Baker, Fiscal Officer
Mr. Kevin R. Robling, Trustee
Mr. Dustin Dillard, Fire Chief
Mrs. Christine Bartlett, Legal Counsel
Headquarters, Bulletin Board
Station No. 22, Bulletin Board
Station No. 24, Bulletin Board
Station No. 29, Bulletin Board

Mr. Mark Kruzan, Vice-Chair
Ms. Christina Courtright, Trustee
Mr. Daniel Vest, Trustee
Mr. David Ferguson, Legal Counsel

Station No. 21, Bulletin Board
Station No. 23, Bulletin Board
Station No. 25, Bulletin Board
Station No. 39, Bulletin Board

Handbook Policy Revisions

Pg 36- Overtime Compensation

Personnel may accumulate additional overtime hours outside their normal shift. This overtime will be compensated for at a rate of 1½ times. All overtime will be paid at the end of the 28-day period. All overtime must be submitted within 72 hours of completions and shall have all supporting records to verify the overtime.

When overtime is offered, it will typically be offered in 12 or 24-hour increments. Employees wishing to be contacted for overtime shall keep their contact information including phone number current in the Aladtec system.

Non-Premium Over-Time - This is the mandatory amount accumulated each 28-day cycle for each member on each shift. Maximum allowable number of hours worked on-duty at regular time shall be 212 hours during a 28-day period. Non-Premium overtime accruing during the normally scheduled shifts will be paid at a rate of half time. Non-premium overtime is paid at the end of the 28-day period. Educational leave scheduled on shift will be counted as working time.



Handbook Policy Revisions

Pg 31- Sick Time

The primary purpose of sick time is for use when an employee or a family member living in the employee's household is ill or injured. Employees will be granted 120 hours of sick time at the beginning of each calendar year (pro-rated for mid-year hires). Sick time shall be limited to 120 hours or (5) 24 Hour shifts. Any call-ins within 24 hours of a scheduled shift may require a doctor's statement. Sick time must be used within the year and may not be carried over to the following year. Any unused sick time at the end of a calendar year will be forfeited.



Handbook Policy Revisions

Pg 60- Minimum Staffing Bullet point # 3

There shall be one officer on duty at ~~each~~ MFPD Station with 3 or 4 Personnel Personnel working (where applicable, the Company Officer and Sergeant may not be off at the same time. Trading of time does not validate an exception.)



Handbook Policy Revisions

Pg 32/45/49- Trading Duty Time

Shift trading is an agreement between employees. This agreement is made solely between the trading individuals and is allowed for their convenience. An individual agreeing to a trade is agreeing to a work schedule change. It is the responsibility of the employees to ensure that the Battalion Chiefs from each affected shift are notified in advance. The employee agreeing to work for another employee accepts all responsibilities for tracking hours owed to individuals. When an employee calls off sick or fails to report to work as scheduled for a trade, that employee will be held accountable for the shift. Any firefighter may trade with another firefighter who is not scheduled to work the same shift, provided that firefighter meets the qualifications for the position. Firefighters trading shifts must ensure that the shifts are traded equally within the 28-day period for full-time and part-time firefighters. Both ends of the trade must be arranged before the first trade begins.

The following restrictions are in place for firefighter trades:

1. Minimum trade time, 4 hours.
2. ~~Initiate maximum of 72 hours per year.~~ Trades must be within the 28-day period
3. A Shift Trade must be requested at least 72 hours prior to the desired shift trade.
4. Entire trade must be arranged and approved before trading begins.
5. Administration must approve all trade requests.
6. Shift trades shall not impair the operational effectiveness of the MFPD.
7. Shift trades shall not create a logistical or financial burden to the MFPD.
8. No shift trades are allowed that place an employee into undue overtime.



Handbook Policy Revisions

Disciplinary Action:

In July 2023 Fire Protection District's became subject to Indiana Codes related to Public Safety Boards. The Administration and Legal Counsel are still ironing out the language to fit in the Disciplinary Action portion of the Handbook. 36-8-3-4. Disciplinary powers of safety boards in cities, towns and townships. (Fire Protection Districts as identified in the Code)

Insert the following language:

The Monroe Fire Protection Board of Trustees shall be the Public Safety Board identified in Indiana Code 36-8-3-4.

This language shall be inserted into the Disciplinary Action Section prior to Progressive Discipline



Monroe Fire Protection District

3953 S. Kennedy Drive
Bloomington, Indiana 47401 -9619

Business: (812) 331-1906

Fax: (812) 336-1166

January 1, 2024

Ordinance 01-2023

Salary, Wages, Compensation and Allowances Ordinance

An ordinance stipulating the salary, wages compensation and allowances of persons who are compensated by the Monroe Fire Protection District, Bloomington, Indiana, for the calendar year 2024

Payments of amounts as indicated within this ordinance are subject to budget approval of such amounts by the Monroe County Council and the Department of Local Government Finance (DLGF), either of which have authority to adjust annual budget amounts. In the event an adjustment in this ordinance is required, it will be accomplished by Board action correcting this ordinance or enacting an amended or revised edition of this ordinance.

Be it ordained by the Board of Trustees of Monroe Fire Protection District, and subject to the aforementioned budget approvals that the following provisions pertaining to salary, wages, compensation and allowances be in effect for calendar year 2024.

1.) Full Time Employees' Salary:

<u>Title/Position</u>	<u>Salary per annum</u>
Chief (1)	\$ 88,267.00
Deputy Chief (4)	\$ 82,750.00
Assistant Chief (3)	\$ 77,233.00
IT Specialist (1)	\$ 80,340.00
Battalion Chief (6)	\$ 71,717.00
Fire Marshal (2)	\$ 71,717.00
1st Class Firefighter (79)	\$ 66,200.00
Administrative Assistant (2)	\$ 72,343.00

Part - Time Employees - \$15.00 - \$25.00 / hr.

2.) Substitute / Emergency / Overtime / Training:

Substitute employees will be paid in the amount of \$15.00 - \$25.00 per hour, based on qualifications.

Full-time employees will be paid at Individual Overtime Rates.

Full-time employee off-duty Training Pay is paid at Individual Overtime Rates.

3.) Officer Pay:

Officers of the department will be paid the following amounts per annum for their position. Officers' pay for persons who are full time employees may be pro-rated and paid two (2) times a month salary. Except as noted** Not subject to Cost of Living Adjustment.

<u>Title</u>	<u>Per Annum **</u>
Fire Chief (1)	\$ 20,000.00
Deputy Chiefs (4)	\$ 15,000.00
Assistant Chiefs (3)	\$ 12,500.00
Battalion Chiefs (6)	\$ 10,000.00
Captains (8)	\$ 7,500.00
Company Officers (16)	\$ 3,500.00
Sergeants (15)	\$ 2,500.00
Chauffeurs (12)	\$ 1,500.00
Engineer	Per ride out pay schedule
Part time Chauffeurs (6)	\$ 750.00

4.) Longevity:

All full-time employees: The amount of One hundred and fifty dollars (\$150) per year will be paid to full time employees for each full year of service satisfactory to, or accepted by, and calculated by the district using their procedures, up to twenty (20) years or a maximum of three thousand (\$3,000.00) This amount will be included in regular salary and included in the regular two (2) times a month pay. Longevity will be calculated on number of years of creditable service completed with or accepted by this district as creditable after one year of service and as of the calendar year of the member's anniversary.

5.) Allowance Payment in lieu of health insurance:

All full-time employees. The amount of Three Thousand dollars (\$3,000.00) per annum may be paid to a full-time employee, who elects to provide his or her own **Medical** insurance in lieu of the department paid Group **Medical** insurance. **This allowance annual incentive payment will be paid in 24 equal amounts and included in the two (2) times a month pay.** This allowance payment will not be paid separately, e.g. by a separate check if no pay is due. (Approved March 1997 SBA auditor). This \$3,000 is in lieu of taking District health insurance and shall not be included in regular pay or calculated into hourly rates.

6.) Incentives:

Full time Employees: An amount up to Twelve hundred dollars (\$1,200) per annum may be paid to persons who attain/maintain Emergency Medical Technician (EMT) status and perform these duties satisfactorily. This amount will be paid from the incentive line in the annual budget and will be pro-rated for employees who start or terminate employment mid-year. Qualifying Full time employees may receive up to \$600.00 payable in June and up to \$600.00 in December.

Part-time and Volunteer Employees: An amount up to Six hundred dollars (\$600) per annum may be paid in December to persons who attain/maintain first responder (EMR) or Emergency Medical Technician (EMT) status and perform these duties satisfactorily. This amount will be paid from the incentive line in the annual budget and will be prorated for employees who start or terminate employment mid-year.

An amount up to Five hundred dollars (\$500) per annum may be paid to persons who attain/maintain HazMat Tech Certification. **Full time employees** will be paid this amount from the incentive line in the annual budget and it will be included in the two (2) times a month pay check. **Part time employees** who attain/maintain HazMat Tech Certification receive the \$500.00 in December. (Pro-rated for mid-year hires/terminations)

An amount up to Five hundred dollars (\$500) per annum may be paid to **full time employees** who hold or attain an Associate's degree. An amount up to One thousand dollars (\$1,000) per annum may be paid to **full time employees** who hold or attain a Bachelor's degree. This amount will be paid from the incentive line in the annual budget and will be included in the qualifier's two (2) times a month pay check.

7.) Uniform Allowance:

Full time employees will be paid the amount of One thousand five hundred dollars (\$1,500.00) per annum for procurement and maintenance of required uniforms. The \$1,500.00 will be distributed equally in two payments of Seven hundred fifty dollars (\$750.00) each, normally in June and December. Amount will be pro-rated for mid-year hires/terminations.

Part time employees will be paid the amount of Five hundred dollars (\$500.00) per annum, distributed equally in two payments of Two hundred fifty dollars (\$250.00) each, normally in June and December. Amount will be pro-rated for mid-year hires/terminations.

8.) Length of Service Annuity:

For Volunteers only, and in accordance with the District approved program (LOSAP). Persons, who are members of the Indiana Fireman and Policeman Retirement Fund, INPRS, are not eligible to participate in this program.

9.) Trustee Compensation:

Board of Fire District Trustees will be compensated an amount of \$3,707 per annum, as indicated below: Chair, Vice Chair, Fiscal Officer & Four (4) Board Members will each be paid a compensation distributed equally and quarterly, based upon a calendar year and normally paid on March 1, June 1, September 1 and December 1.

10.) Contract with the Monroe Fire Protection District Volunteers, Inc.:

Per negotiated contract.

11.) Certified Salary:

The certified salary for a Full-time 1977 Fund first class firefighter for calendar year 2024, will be **sixty-six thousand, two-hundred dollars (\$66,200)** plus longevity up to 20 years, which is a maximum of three thousand dollars (\$3,000) for a total of **sixty-nine thousand, two-hundred dollars (\$69,200)**. **1977 Fund contribution increase takes effect with the first payroll in January each year.**

12.) Overtime:

Overtime rate is set at time and a half with the District Board's approval of this Salary Ordinance.

13.) Withholding for Group Health Insurance:

Full time employees: Each participant will have five to fifteen percent (5% - 15%) of the gross premium withheld from their pay in the two (2) times a month pay check, 24 pay periods per annum, for Group Medical, Dental and Vision insurance.

Employees must notify the Human Resources Administrative Assistant (HRAA) in writing within thirty (30) days of beginning employment if they wish to enroll in the District's insurance plans. Employees must also notify the HRAA by August 1 of the preceding year if they plan to add any eligible dependents to the District's insurance plans the following calendar year. Failure to notify HRAA in writing may require additional contributions be made by the employee. Eligible dependents may be added to the District's health insurance plans effective January 1. Life events such as Marriage, Divorce, Death of a Spouse or Dependent & Birth or Adoption of a Child must be communicated to the HRAA in writing within 30 days of the event.

Employees choosing the High Deductible Health Plan may elect to open a Health Savings Account (HSA). The District will make contributions to each employee's HSA totaling Two thousand dollars (\$2,000) per annum. The contribution will be distributed equally and quarterly, based upon a calendar year and normally paid on March 1, June 1, September 1 and December 1. (Amount will be prorated for mid quarter hires/terminations)

14.) Vacation:

Per district approved leave policy.

15.) Holidays:

Full and part-time personnel. Holidays, except those listed in the next paragraph, will be worked as regular shifts.

16.) Holiday Pay:

Persons who work a full 24-hour shift on any of the following listed ten (10) holidays will be paid an additional amount of One hundred dollars (\$100.00) per shift. Holiday shift commences at 0700 hours local time on the day of the holiday. Personnel must work their full shift to receive full additional pay or 12 hours to receive half (\$50.00)

- 1. New Year's Day
- 2. Good Friday
- 3. Memorial Day
- 4. Independence Day
- 5. Labor Day
- 6. Veterans Day
- 7. Thanksgiving Day
- 8. Christmas Eve
- 9. Christmas Day
- 10. New Year's Eve

Administrative personnel shall receive holidays off with pay following the schedule of holidays approved by the Monroe County Board of Commissioners.

17.) Mileage Reimbursement:

Mileage reimbursement is considered for employees using their personal vehicle while performing District business. The rate will be determined by the IRS standard mileage rate for business travel.

18.) Early Retirement

Full time employees enrolled in INPRS PERF (not including the PERF '77 fund) may be eligible for a one-time payment, limited to \$25,000, to supplement the employee's INPRS benefits until the employee is eligible for Medicare. Refer to the MFPD Employee Handbook for further details.

19.) Ride Out Pay Schedule

This section applies to merited chauffeurs and engineers as detailed below:

Chauffeurs to Officer	12hr rate	\$15.00	24hr rate	\$30.00
Engineer to Officer	12hr rate	\$20.00	24hr rate	\$35.00

Ordinance 01-2023
Salary, Wages, Compensation and Allowances Ordinance

**PASSED BY THE BOARD OF TRUSTEES OF THE MONROE FIRE PROTECTION DISTRICT
BLOOMINGTON, MONROE COUNTY, INDIANA, ON THIS 13TH DAY OF DECEMBER 2023.**

"AYES"

"NAYS"

Vicky Sorensen, Chair

Vicky Sorensen, Chair

Michael Baker,
Fiscal Officer

Michael Baker,
Fiscal Officer

Mark Kruzan, Vice Chair

Mark Kruzan, Vice Chair

Daniel Vest, Board Trustee

Daniel Vest, Board Trustee

Christina Courtright, Board Trustee

Christina Courtright, Board Trustee

Board Trustee

Board Trustee

Kevin R. Robling, Board Trustee

Kevin R. Robling, Board Trustee

ATTEST: _____
Michael Baker, Fiscal Officer



Monroe Fire Protection District



2024

BOARD OF TRUSTEES

REGULAR MEETING SCHEDULE:

<p>January 10th Station 21 9094 S. Strain Ridge Road</p>	<p>February 14th Station 25 5081 N. Old State Road 37</p>	<p>March 13th Station 21 9094 S Strain Ridge Road</p>
<p>April 10th Station 25 5081 N. Old State Road 37</p>	<p>May 8th Station 21 9094 S Strain Ridge Road</p>	<p>June 12th Station 25 5081 N. Old State Road 37</p>
<p>July 10th Station 21 9094 S. Strain Ridge Road</p>	<p>August 14th Station 25 5081 N. Old State Road 37</p>	<p>September 4th Budget Work Session 9094 S. Strain Ridge Road Station 21</p>
<p>September 11th Station 21 9094 S. Strain Ridge Road</p>	<p>October 9th Station 25 5081 N. Old State Road 37</p>	<p>November 13th Station 21 9094 S. Strain Ridge Road</p>
		<p>December 11th Station 25 5081 N. Old State Road 37</p>

Per IC 36-8-11

(a) The board shall fix the time for holding regular meetings, but it shall meet at least once in the months of January, April, July, and October. The county legislative body may order that regular meetings be held more frequently. (b) Special meetings of the board may be called by the chairman or by two (2) trustees, upon written request to the secretary. At least three (3) days before a special meeting, the secretary shall send to all trustees a written notice fixing the time and place of the meeting. Written notice of a special meeting is not required if: (1) the time of the special meeting has been fixed in a regular meeting; or (2) all trustees were present at a meeting at which a special meeting was called.



Monroe Fire Protection District



2024

BOARD OF TRUSTEES

REGULAR MEETING SCHEDULE:

January 10 th Station 21 9094 S Strain Ridge Road	February 14 th Station 25 5081 N. Old State Rd 37	March 13 th Station 21 9094 S Strain Ridge Road
April 10 th Station 25 5081 N. Old State Road 37	May 8 th Station 21 9094 S Strain Ridge Road	June 12 th Station 25 5081 N. Old State Road 37
July 10 th Station 21 9094 S. Strain Ridge Road	August 14 th Station 25 5081 N. Old State Road 37	September 4 Budget Work Session Station 21 9094 S Strain Ridge Road
September 11 th Station 21 9094 S. Strain Ridge Road	TBD Nat U Hill Room Budget Adoption	November 13 th Station 25 5081 N. Old State Rd 37
		December 11 Station 21 9094 S. Strain Ridge Road

Per IC 36-8-11

(a) The board shall fix the time for holding regular meetings, but it shall meet at least once in the months of January, April, July, and October. The county legislative body may order that regular meetings be held more frequently. (b) Special meetings of the board may be called by the chairman or by two (2) trustees, upon written request to the secretary. At least three (3) days before a special meeting, the secretary shall send to all trustees a written notice fixing the time and place of the meeting. Written notice of a special meeting is not required if: (1) the time of the special meeting has been fixed in a regular meeting; or (2) all trustees were present at a meeting at which a special meeting was called.

Monroe Fire Protection District

Statistical Summary



November 1-30, 2023

INCIDENTS BY CATEGORY:	COUNT:
Fires	39
<i>Structure</i>	5
<i>Vehicle</i>	4
<i>Wildland</i>	17
<i>Other</i>	13
Over Pressure Rupture	1
Emergency Medical Service Calls	209
<i>Medical</i>	136
<i>EMS Crew Assist</i>	43
<i>Motor Vehicle Accident / Rescue</i>	30
Hazardous Condition (no fire)	23
Service Calls	40
Good Intent Calls	33
False Alarms	19
Severe Weather	0
Special Incidents	7
TOTAL	371

INCIDENTS BY DISTRICT TOWNSHIP	
Benton	20
Bloomington	26
Clear Creek	35
Indian Creek	3
Perry	104
Van Buren	122
Washington	17
TOTAL	327

INCIDENTS BY FIRE PROTECTION CONTRACTED TOWNSHIPS	
Polk	4
Salt Creek	14
TOTAL	18

INCIDENTS BY AID GIVEN

Bean Blossom	1
Bloomington (City)	1
Ellettsville	4
Richland Township (EFD)	10
Greene County	9
Lawrence County	0
Brown County	1
Owen County	0
Morgan County	0

TOTAL 26

EFD Aid Received - (November 51
Aid Received - Year to Date 138 (15 in Nov)

Average RESPONSE Time (Dispatch to Arrival)

STATION	EMS		FIRE	
	<u>October</u>	<u>November</u>	<u>October</u>	<u>November</u>
Station 21	9:38	10:15	11:34	15:46
Station 22	6:14	6:19	6:25	10:49
Station 23	9:14	5:40	7:22	
Station 24	11:18	9:49	13:21	14:30
Station 25	9:35	8:29	7:33	14:44
Station 29	5:31	6:17	6:12	6:14
Station 39	7:51	7:05	10:30	7:33

AVERAGE FOR ALL CALLS 7:25 7:45

Average TURNOUT Time (Dispatch to En-route)

STATION	EMS		FIRE	
	<u>October</u>	<u>November</u>	<u>October</u>	<u>November</u>
Station 21	1:21	1:30	1:16	1:52
Station 22	0:55	1:05	1:10	1:26
Station 23	1:36	2:31	0:54	
Station 24	1:20	0:56	0:55	2:00
Station 25	1:23	1:23	1:02	3:03
Station 29	0:50	0:54	0:57	1:03
Station 39	0:51	0:45	1:07	1:19

AVERAGE FOR ALL CALLS 1:02 1:07

AVERAGE TIME SPENT ON SCENE 26:52 32:25

Number of Refusals Obtained by MFD Personnel 3

INCIDENTS: REVIEWED INCIDENT COUNTS

Monroe Fire Protection District | Last Refresh: 12/6/2023 8:00 PM

366 Incidents Filtered | 18 Not Reviewed | 4,057 Incidents YTD | 4,137 Prior YTD | -80 Δ over PYTD | -2% % over PYTD

of Incidents by Month

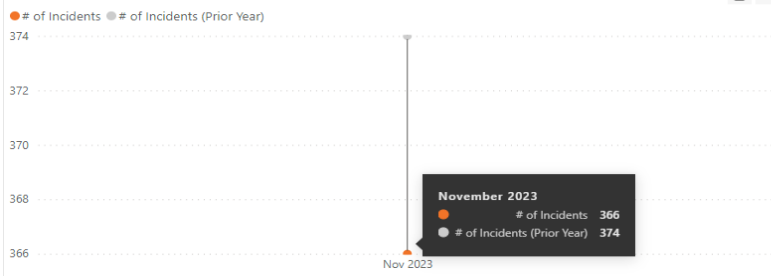

Incident Series	# of Incidents
1XX - Fire	38
2XX - Overpressure Rupture, Explosion, Overheat(no fire)	1
3XX - Rescue & Emergency Medical Service Incident	205
4XX - Hazardous Condition (No Fire)	23
5XX - Service Call	40
6XX - Good Intent Call	33
7XX - False Alarm & False Call	19
9XX - Special Incident Type	7
Total	366

Top Stations by # of Incidents

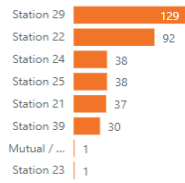

of Incidents by Shift

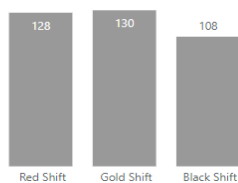

of Incidents by Category

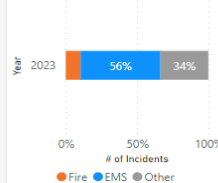

INCIDENTS: DAYS & TIMES

Monroe Fire Protection District | Last Refresh: 12/6/2023 8:00 PM

366 Incidents Filtered | 18 Not Reviewed | 4,057 Incidents YTD | 4,137 Prior YTD | -80 Δ over PYTD | -2% % over PYTD

of Incidents by Hour of the Day

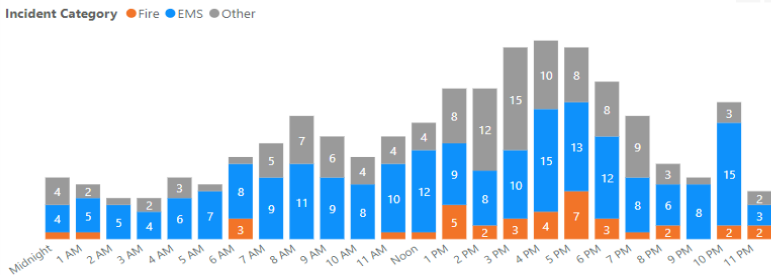

of Incidents by Weekday and Incident Category

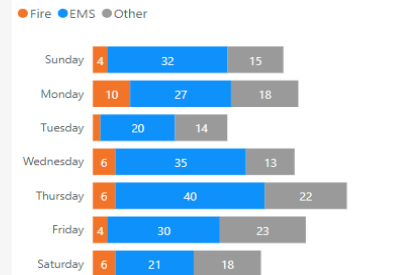

Top Stations by # of Incidents

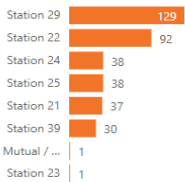

of Incidents by Shift

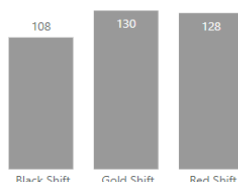

of Incidents by Category

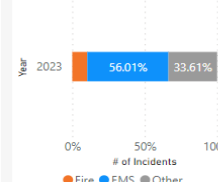

of Incidents over Time

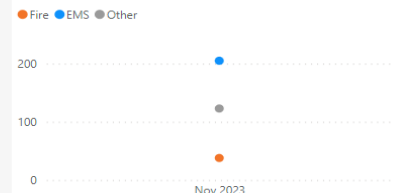

EMS / Special Operations

CURRENT SITUATION

- Continuing work on Tactical Support Unit at Station 21
- Collapse/trench apparatus and trailer
- Brush / EMS squad combination
- Receiving equipment and supplies for ambulances

ACCOMPLISHMENTS

- Received report for annual physicals
- Work Performance Evaluations concluded
- Hazmat Inservice is scheduled for May 2024
 - Hazmat IQ class
- Meeting with Morgan County EMS

PLANNED ACTIVITIES

- Ambulance Transport process/paperwork
- Finalize ambulance billing partnership
- Follow-up meeting with IULL (IU Life Line)
- Training and orientation manual for ambulance personnel

Operations Monthly Report December 2023

Current Situation

Out of Service / In Service

- Tender 22 – Pump replacement (see photo attached)
- Rescue 21 - Hydraulic line replacement (x4)
- Engine 29 – Engine leaking oil (under warranty)
- Engine 43 – Pump problems

Accomplishments

- Hydrostat Testing for the 2018 SCBA bottles have been completed
- Flow testing of all air packs and masks have been completed
- Ladder Testing completed
 - Station 25 Gold Shift was at tremendous help in getting this project done.
- New gear has been ordered (17.5 sets)
- New FLIR K45 (Station 24) in service on 11-27-2023
- Work Orders Completed – 24 Total
 - 2 Major
 - 12 Minor
 - 10 Moderate

Planned Activities

- Make up testing of bottles that missed hydrostat testing.
- Implement an identification system of all SCBA bottles

December 2023 Training Report

CURRENT SITUATION

- Rope Ops Retest
- Planning for 2024 shift training
- Planning for Certification classes
- Testing with Ivy Tech current Firefighter Students on state Certification Hazmat skills
- MFD Fire Instructors meeting to plan state certification classes for 2024 with in IDHS District 7 – (7 counties represented)

ACCOMPLISHMENTS

- Training hours
 - Full Time firefighter – 1714.75
 - Part-time firefighter- 475.15
 - Volunteer- 27.75
 - **Total- 2217.65**
- Firefighter I/II class Finished - Four MFD Volunteers passed for State Firefighter Certification
- Held 2-day Rescue Task Force Training – Active Threat Integrated Response
- County Wide Training Held with Ellettsville and Bloomington City fire departments – Attic Fire Response/ Flue Fires
- Facility Training - All MFD stations completed skill stations on the following:
 - I Gel- New improved airway device used in EMS incidents
 - Scene Utilities control
 - Dexterity skill
 - Messy SCBA
 - SCBA search
 - Vehicle fire
 - Pumping
 - Drafting

PLANNED ACTIVITIES

- Ice Rescue
- Elevator Rescues
- Driving in Inclement Weather
- Preparing for Fire Scene Investigations

CRR Monthly Report December 2023

▪ CURRENT SITUATION

- Investigating fires on Airline Dr and Benton Dr
- Initiating program to follow up with overdose incidents
- Arson Case preparation with Prosecutor (Rescheduled for January)
 - Terrace Drive
- Continued coordination for Eclipse 2024
- Considering the potential of a Mobile Crisis Response Team as a partnership with the Indiana Department of Health and Center Stone

▪ ACCOMPLISHMENTS

- Attended VA Just Like Me: Presented by Creative Arts for Vets and IU Center for Veterans and Military Students
- Participated in the CJAM (Criminal Justice & Mediation Center) “Come to the Table-The Art of Peace” Annual Fundraiser
- Attended Monroe County Childhood Conditions Summit
- NaloxBoxes
 - Distributed 15 overdose kits
 - Plus an additional kit taken to overdose survivor family
- 2 Referrals to Adult Protective Services/Area 10 on Aging
- Completed 33 inspections, 56 re-inspections, 6 new construction inspections, and conducted 3 plan reviews.
 - Added 15 new occupancies that were not accounted for in the database

▪ PLANNED ACTIVITIES

- Initiate the potential for CISM (Critical Incident Stress Management) team from mental health providers to assist with fire department members' wellbeing
- Develop the SHIELD Domestic violence safe place at fire stations
- Provide a presentation to the Department of Children Services Monroe County
- Hoosier Burn Camp Scheduled for Monday July 15 and Tuesday July 16

ADMINISTRATIVE REPORT DECEMBER 2023

Current Situation

- Co-Chairing Monroe County Public Safety Sub-committee for 2024 Solar Eclipse planning
- Assessing end of year needs for projects and purchases identified throughout the year
- Still working to get the Station 26 project into position to bid
- Reviewing 2023 legislation that has taken effect and includes Fire Protection Districts in Public Safety Board legislation for revisions to the Personnel Handbook
- Preparing revisions to the Personnel Handbook identified throughout 2023
- Working with Community Risk Reduction to develop a Fire Inspection Program that fills voids that existed prior to having a Fire Marshal and meets the needs of the community
- Developing the components of a large hiring process for early 2024
- ESO onboarding and building our parameters for use in 2024
- Currently working on 2024 Health Insurance re-enrollments

Accomplishments

- Spoke with a firefighter who is now assisting Fleet with administrative tasks
- Assisted the volunteer association with the Chili Supper at the Monroe County Fairgrounds. The event was a success
- Onboarded three additional full-time firefighters, exhausting the current hiring list
- Concluded the insurance renewal with Capstone Insurance which includes Worker's Compensation, property, liability and blanket coverage.
- 7710 Insurance completed a site visit to review previous worker's compensation claims and to work on preventing injuries and increasing quality of care provided to employees
- Joined the volunteer association and Local 5343 for several boot drives to fund the Shop With a Firefighter program
- Discussed Fire Protection Districts with elected officials in Morgan County
- Evaluating ways to improve inventory tracking and testing of SCBA's with officer in charge
- Held two 1977 Fund pension board meetings to review and adopt bylaws in preparation for 2024
- Attended a meeting with a representative of the Bloomington Chamber of Commerce to discuss future programs for fire responders and increased involvement from the Chamber
- Met virtually with ESO for a "kick off" call to start the onboarding process.
- Auxiliary hosted the Cookies with Mrs. Claus event for fire department families
- Santa Parades began December 2
- Assisted Lakeview PTO (parent/teacher organization) in a fundraiser for the school by providing a "ride to school in a fire truck" for their silent auction
- Attended the first official countywide fire chiefs' meeting since 2021 with fire chiefs of Bloomington, Ellettsville and Bean Blossom
- Attended volunteer association meeting to discuss changes in the management of personnel and future services
- Participated in the Blue-Ribbon Commission for Climate Resilience Solutions Workshop
- Thanks to all personnel who participated in the PTO donation for a fellow firefighter

ADMINISTRATIVE REPORT DECEMBER 2023

Planned Activities

- Santa Parades will continue through the remainder of December
- January 16th we will host a ceremony honoring Recruit Class 003 and formally ending their probationary period
- Research and Development organizational meeting and plan schedule for first quarter of 2024
- Shop with a Firefighter
- ESO implementation by January 1, 2024

Resolution to Transfer Funds from the Operations Fund To the Rainy Day Fund

BE IT RESOLVED, that the members of the Monroe Fire Protection District Board of Fire Trustees do hereby authorize and direct the Monroe Fire Protection District Financial Assistance to transfer up to \$1,500,000 of unused and unencumbered funds from the GENERAL Fund to the Rainy Day Fund. This amount shall not exceed fifteen percent (15%) of the total annual budget for the fiscal year.

Approved by the Board of Fire Trustees of the Monroe Fire Protection District at its regular meeting on December 13, 2023.

AYE

NAY

Vicky Sorensen, Chair

Vicky Sorensen, Chair

Mark Kruzan, Vice-Chair

Mark Kruzan, Vice-Chair

Michael Baker, Fiscal Officer

Michael Baker, Fiscal Officer

Christina Courtright, Board Trustee

Christina Courtright, Board Trustee

Kevin R. Robling, Board Trustee

Kevin R. Robling, Board Trustee

Daniel Vest, Board Trustee

Daniel Vest, Board Trustee

LOW PROFILE HIGH EXPECTATIONS

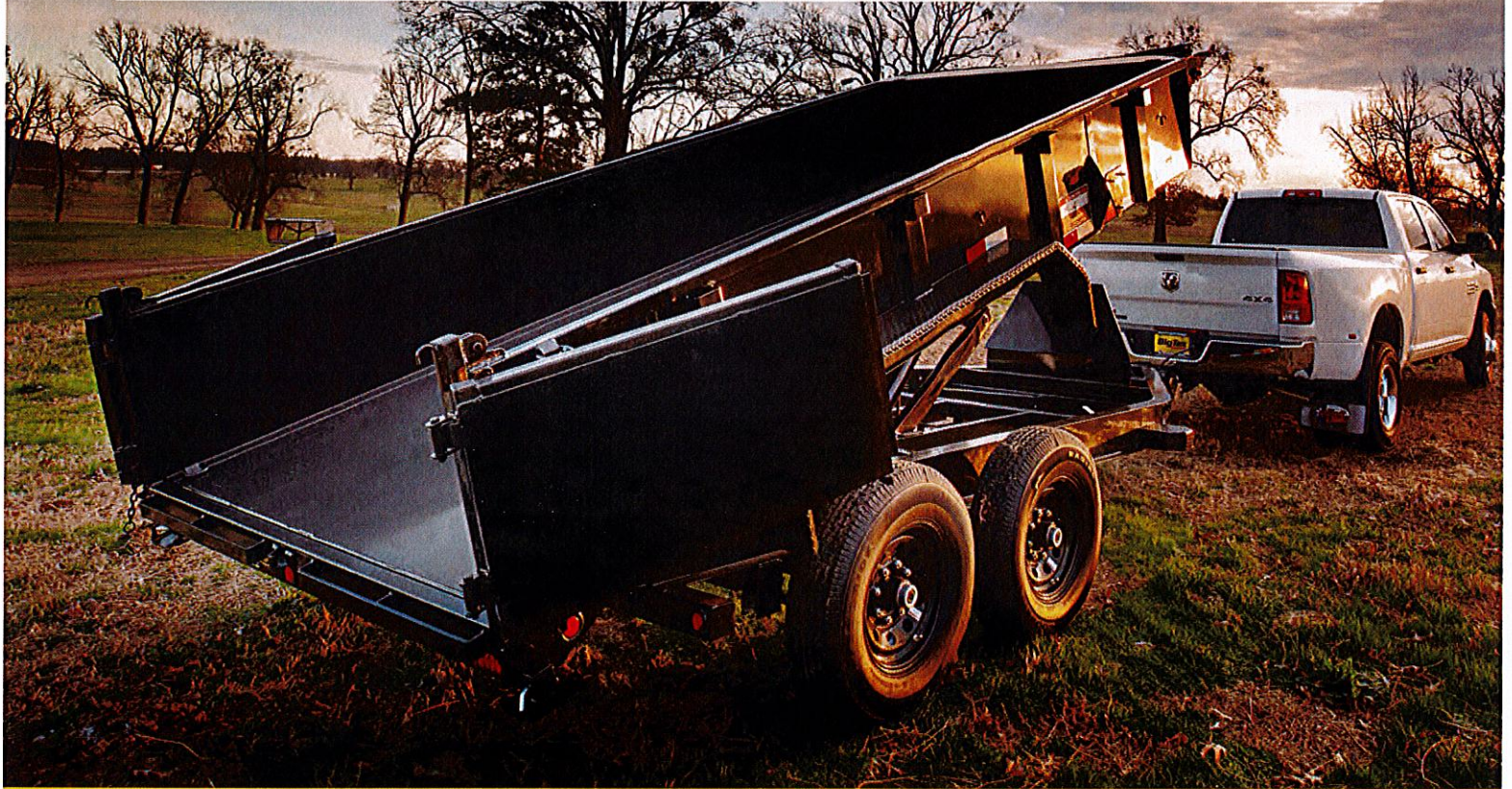

The newly redesigned **14LP Ultra Low Profile Dump Trailer** from Big Tex makes loading easier, safer and more convenient than ever before. With a durable frame design and premium feature set, the 14LP delivers lasting strength and incredible value.

\$10,499



BigTex
TRAILERS®

www.bigtextrailers.com/14LP

14LP HEAVY DUTY LOW PROFILE BUMPERPULL DUMP TRAILER

GWWR: 14,000#

EMPTY WEIGHT: 4,180# (14' Model)

AVAILABLE LENGTHS: 14'-16'

BED WIDTH: 83" WIDE

COUPLER: Adjustable 2-5/16" EZ Latch Demco

BigTex TRAILERS

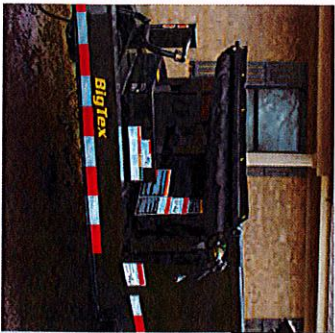
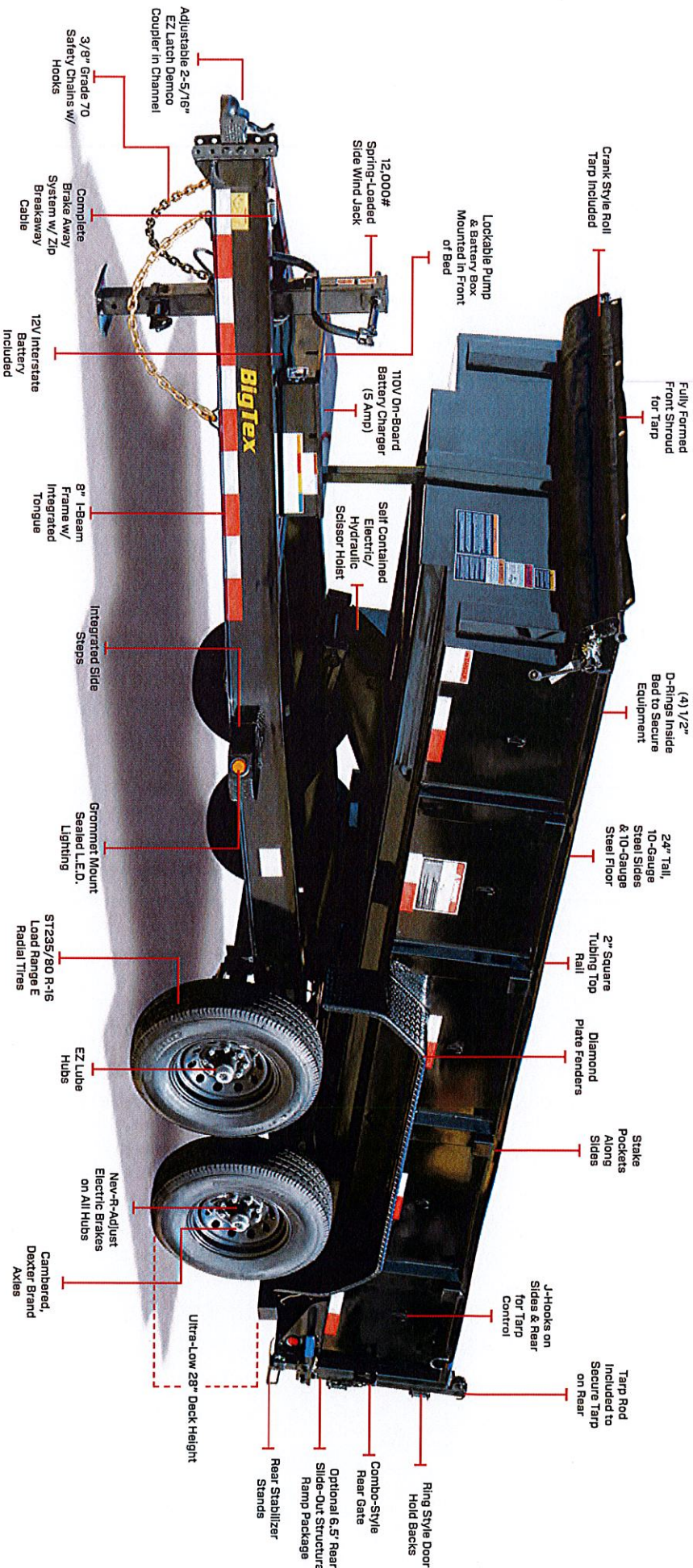

INTEGRATED 8\"/>

To add strength and durability, the 14LP features an 8\"/>



READY FOR HAULING EQUIPMENT

The 14LP is perfect for hauling equipment when the optional 6.5\"/>



THINK \"INSIDE\" THE BOX

A sturdy 2\"/>



14LP ▾

Trailers / Dump Trailers / Commercial-Grade Dump Trailers

ADD TO COMPARE





HEAVY DUTY DIAMOND PLATE STEEL FENDERS

Built to stand up to whatever punishment is thrown at it, these fenders keep your trailer protected and are also removable to allow for easy replacement if damaged.

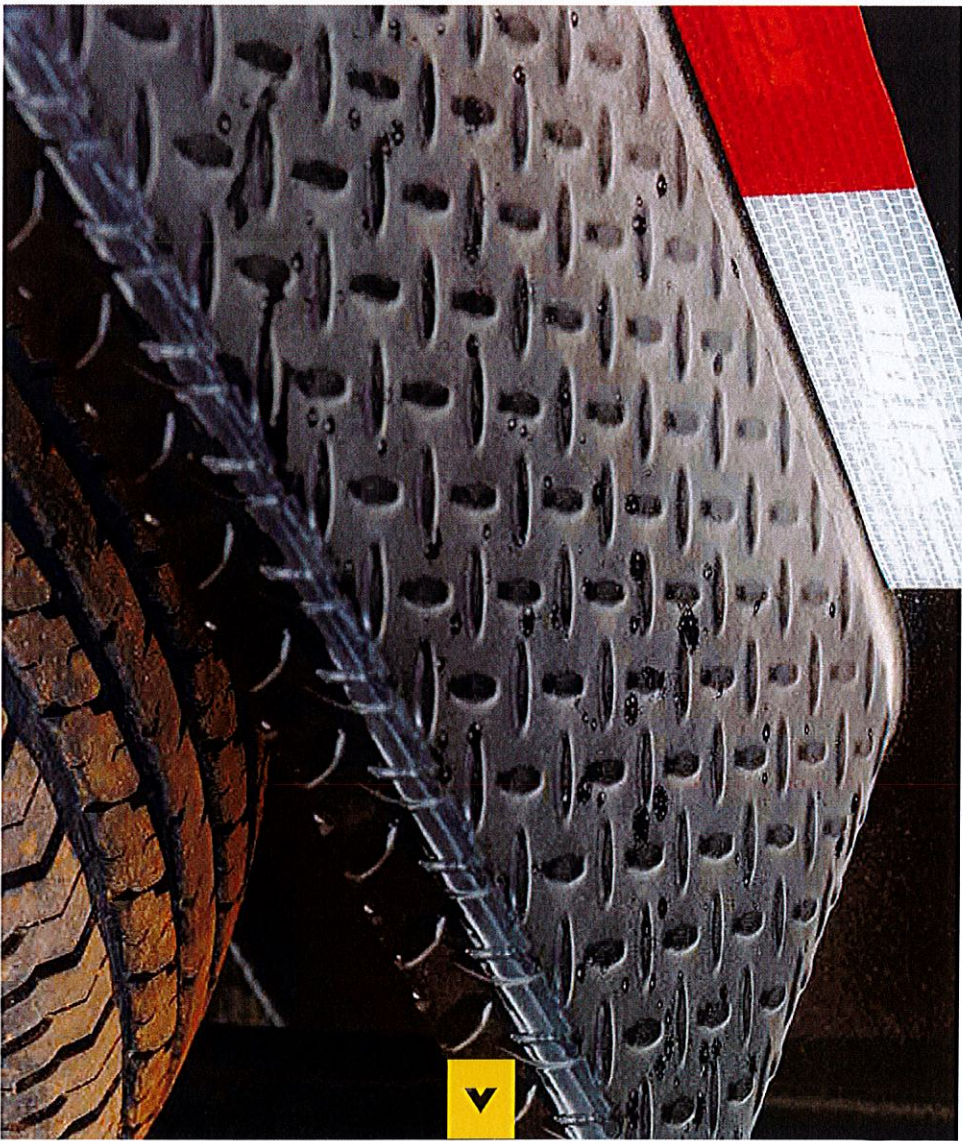



14LP ▾

ADD TO COMPARE ○

MODEL	PULL TYPE	GWR	EMPTY WEIGHT	CARGO CAPACITY	BED LENGTH	BED WIDTH	A	B	C	TONGUE LENGTH
14LP-16	Bumperpull	14000 lbs	4250 lbs	8.3 lbs	16'	83"	192"	115-3/4"	76-1/4"	51-1/8"
14LP-14	Bumperpull	14000 lbs	4180 lbs	7.2 lbs	14'	83"	168"	100"	68"	51-1/8"
14LP-12	Bumperpull	14000 lbs	3870 lbs	6.1 lbs	12'	83"				51-1/8"



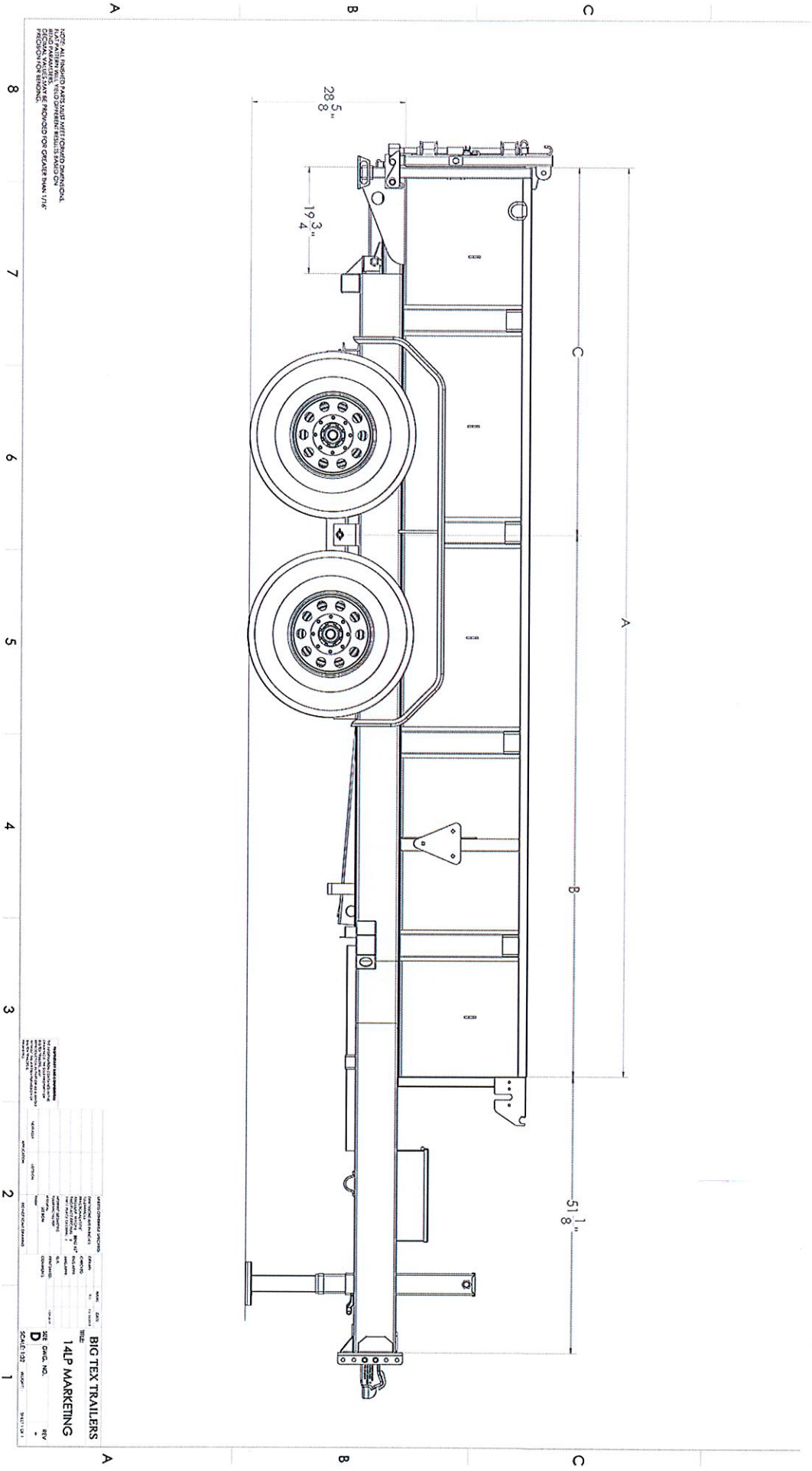

NOTE: ALL DIMENSIONS PARTS LISTED TOWARD DIMENSIONAL END OF PART ARE TO BE USED FOR DIMENSIONAL PURPOSES ONLY. DIMENSIONS SHOWN ON DRAWING SHALL PREVAIL OVER DIMENSIONS SHOWN ON PARTS LIST.

ITEM NO.	DESCRIPTION	QTY	UNIT
1	TRAILER	1	EA
2	WHEEL	2	EA
3	AXLE	2	EA
4	SPRINGS	2	EA
5	SHOCKS	2	EA
6	SAFETY CHAINS	2	EA
7	WARRANTY CARD	1	EA

BIG TEX TRAILERS
14LP MARKETING
 1000 S. 10th St., P.O. Box 1000
 Big Tex, TX 79411
 817-231-1111



70SR

Tandem Axle Single Ram Dump

Width:

60"

Length:

12'

GVWR:

7,000 lbs

Cargo Capacity:

3 lbs

COMPARE

VIEW



140D-GN

Heavy Duty Over The Axle Gooseneck Dump

Width:

96"

Length:

14'

GVWR:

14,000 lbs

Cargo Capacity:

6 lbs

COMPARE

VIEW

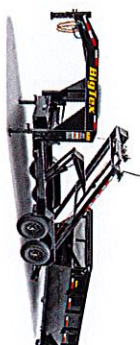

16RD

Roll-Off Gooseneck Dump Trailer (and Bin)

Width:

83"

Length:

14'

GVWR:

17,500 lbs

Cargo Capacity:

0 lbs

COMPARE

VIEW



20GX

Mega Duty Tandem Axle Gooseneck Dump

Width:

83"

Length:

16'

GVWR:

22,000 lbs

Cargo Capacity:

15,450 lbs

COMPARE

VIEW



14LP ▾

ADD TO COMPARE ○



AMERICA'S #1 PROFESSIONAL GRADE TRAILER

FIND A DEALER

[Company](#)

CAREERS

[For Dealers](#)

BIG TEX +



14LP ▾

AFFILIATIONS & PARTNERSHIPS

CONTACT US

877-870-0657

ADD TO COMPARE ○



GET THE LATEST

Sign up for Big Tex news

Name

Email

ENTERNAME

Proud Member



© 2023 Big Tex Trailer Manufacturing, LLC. Privacy Policy

Detro Trailers

Phone: 7655226277

7080 N. US Highway 231

Bainbridge, IN

Email: tony@detrotrailers.com, sales@detrotrailers.com



2022 Norstar/Ironbull 83x14 14K Scissor Dump Trailer

Stock#: N061083	VIN#: 50HDB1429M1061083	Year: 2022
Manufacturer: Norstar	Width: 83" or 6'11"	Length: 168" or 14'0"
Weight: 4855	GVWR: 14000	Payload: 9145
Color: BLACK	#Axles: 2	Axle Capacity: 0.00
URL: https://detrotrailers.com/2022-norstar-ironbull-83x14-14k-scissor-dump-trailer-bu7n.html		

Price	\$13,400.00
Sales Price	\$10,975.00

Description

- Dual 6" (12lbs/ft) I-Beam Frame
- 4" Tubing Bed Frame
- 14,000 lb GVWR
- One-Piece 7 Gauge Floor
- Full Length Underframe Bed Runners
- 24" 10 Gauge Sides with 7 Machined Breaks
- Full Length Bed Runners and Ramp Pockets
- Scissor Hoist
- 10K Drop-Leg Bolt-On Jack
- 3-Way Rear Gate
- Retractable Tarp System
- Spare Tire Mount
- Side Access Step
- 2 5/16" Adjustable Coupler
- Formed 3 x 3/16" Channel Crossmembers
- 14 Gauge Weld On Diamond Plate Fenders
- Locking Pump Box
- Cambered Dexter Nev-R-Adjust Brake Axles
- Multi-leaf Slipper Spring Suspension
- E-Z Lube Hubs
- Radial Tires
- Standard Stake Pockets
- Spare Tire Mount (Weld On)
- Three-Way Gate
- Powdura Powder Coat
- 4 Standard 3" D-Rings and Y-Hooks
- Flow Control Valve
- Lifetime LED Lighting
- Double Acting Power Unit
- 5"x16" Hydraulic Cylinder
- LED Voltage Indicator in Remote
- All Lighting DOT Approved
- Molded Sealed Harness
- Built-In 5 amp AC/DC Battery Charger

- Interstate Deep Cycle Batteries
 - 7-Way Receiver Female Plug with Adapter
 - Three Year Limited Warranty
-

Indiana Trailer Sales

Phone: (260) 301-9251

521 S 13th St.

Decatur, IN 46733

Email: IndianaTrailerSales@gmail.com



2023 Iron Bull 83x14 DWB8314072 Dump Trailer

Stock #: IB1022772-OF VIN #: 3EUDB1422P1022772 Year: 2023

Manufacturer: Iron Bull Width: 83" or 6' 11" Length: 168" or 14'

Weight: 4982 GVWR: 14999 Payload: 10017

Color: GRAY # Axles: 2 Axle Capacity: 14000

URL: <https://www.indianatrailersales.net/all-inventory?stock=IB1022772-OF>

MSRP \$ 14,599.00

Original Price \$ 12,999.00

Sale Price \$ 11,499.00

Description

8" I-Beam Frame & Tongue (10 lbs/ft)

4" Tubing Bed Frame

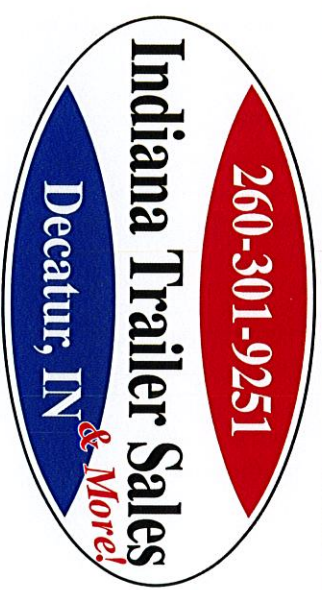

- 7 Ga Floor
- 24" 10 Gauge Steel Sides
- Oversized Front Tool Box
- 10k Drop-Leg Bolt-On Jack
- 3-Way Rear Gate
- Retractable Tarp System
- Standard Slide-In Ramps
- Tandem 7k Dexter Electric Nev-R-Adjust Brake Axles
- Super Lube Hubs
- 5 Amp 12-Volt Wall Charger
- 235/80 R16 Radial Tires
- Stake Pockets
- Rear Support Stand Brackets
- 5 Position 2 5/16" Coupler
- 16" Steel Wheels
- Scissor Lift with 516 Cylinder
- 43 Degree Dump Angle
- 3" Channel Crossmembers on 16" Centers
- Hydraulic Pump
- 12' Corded Remote with LED Voltage Indicator
- 4 Weld In D-Rings

Weld-On 3/8" Safety Chains

14 Gauge Diamond Plate Fenders

Premium Sherwin Williams Powder Coated Black

Lifetime LED Stop, Signal, Marker, & License Plate Lights

6 Leaf Spring Suspension

DOT Reflective Tape

Electric Breakaway Kit with Charger

All Lighting DOT Approved

Molded Sealed Harness

7-Way Plug with Adapter

Detro Trailers

Phone: 7655226277

7080 N. US Highway 231

Bainbridge, IN

Email: tony@detrotrailers.com, sales@detrotrailers.com



2024 Sure-Trac 82x14 14K Telescopic HD Low Profile Dump Trailer w/ Hydraulic Tongue Jack

Stock#: ST412996

VIN#: 5JW1D1424R4412996

Year: 2024

Manufacturer: Sure-Trac

Width: 984" or 82'0"

Length: 168" or 14'0"

Weight: 3880

GVWR: 14000

Payload: 10120

Color: BLACK

#Axles: 2

URL: <https://detrotrailers.com/2024-sure-trac-82x14-14k-telescopic-hd-low-profile-dump-trailer-w-hydraulic-tongue-jack--JYAp.html>

Price

\$13,600.00

Description

OVERVIEW

The Sure-Trac HD Low Profile Dump Trailer is designed for the professional. The low deck height ensures easy loading and unloading of equipment while maintaining ground clearance when fully engaging the dump mechanism. Smart features like underbody ramp and tool storage save you time, while a heavy-duty tube frame and c-channel cross members provide for superior payload capacity. Available in three different hoist options: Dual Ram, Scissor, and Telescopic lift.

FEATURES

- Tube Main Frame
- 24" Sides
- Integrated Side Body Stiffening System
- Board Holders
- Adjustable 2-5/16" Coupler (12K and 14K Models)
- Adjustable 4-Bolt Pintle Eye Coupler (16K Models)
- Safety Chains
- 7-Way RV-Style Molded Plug
- Breakaway Switch with Battery
- EverLink(tm) Wiring Harness
- Sealed Brake Connections
- Setback 7K Drop Leg Jack (12K Models)
- Setback HD 12K Drop Leg Jack (14K and 16K Models)

Stabilizer Jack Receivers (Jacks Optional)
Ramps (Stored Underneath Bed)
HD Reinforced Combo Barn Door Spreader Gate w/Cambar
Tread Plate Fenders
HD Slipper Spring Axles
8K Axle(s) with 3-3/8" Brake (16K Models)
Brakes on Both Axles
Easy Lube Hubs
16" Radial Tires (12K and 14K Models)
17.5" Radial Tires (16K Models)
Silver Wheels
Wheel Assembly, 235 80R16 LRE (12K and 14K Models)
Wheel Assembly, 215 75R17.5 (16K Models)
Powder Coat Finish
10-Gauge Floor
(5) 1/2" D-rings
Stake Pockets
Spare Tire Carrier
Side Steps
Integrated Tarp Mount
18' Mesh Tarp Kit (Installed) (12' and 14' Models)
20' Mesh Tarp Kit (Installed) (16' Models)
Tongue Mounted HD Control Box with Key Lock
Underbody Secure Tool Storage
All LED Lights
Deep Cycle Battery
Battery Charger, 110-Volt
Power-Up, Gravity-Down Hydraulics

While we strive to represent our trailers with 100% accuracy - please call to confirm details of trailer.

Monroe Fire Protection District
Claims - Signed October 30, 2023

Invoices Received 10/19/2023-10/29/2023

<u>Date:</u>	<u>Claim #</u>	<u>Amount:</u>	<u>Payable To:</u>	<u>Description</u>
10/30/2023	EFT	1,310.97	Anthem Blue Vision	Health Insurance - Group Vision Insurance
10/30/2023	EFT	1,209.60	Comcast Business	Telephone / Data - District Data Service
10/30/2023	EFT	669.12	Duke Energy	Utilities - St21
10/30/2023	EFT	94,035.12	IU Health Plans	Health Insurance - Group Medical
10/1/2023	EFT	6,538.14	Paramount Dental	Health Insurance - Group Dental Insurance

Total:
\$ 103,762.95

NOTE:

Monroe Fire Protection District
Claims - Signed October 30, 2023

Invoices Received 10/19/2023-10/29/2023

<u>Date:</u>	<u>Claim #</u>	<u>Amount:</u>	<u>Payable To:</u>	<u>Description</u>
10/30/2023	EFT	1,310.97	Amazon Capital Services	CUM Fund Station Reno - Building Alert Wiring; Industrial Curtain Rods, Rug; Transformer, Speakers, Wiring
10/30/2023	EFT	1,209.60	D&S Maintenance	CUM Fund Station Reno - Winsupply Parts
10/30/2023	EFT	669.12	AFLAC	Voluntary AFLAC - Employee Deduction
10/30/2023	EFT	94,035.12	Centerpoint Energy	Utilities - St21
10/1/2023	EFT	6,538.14	Centerpoint Energy	Utilities - St22

Total:
 \$ 103,762.95

NOTE:

Monroe Fire Protection District
Claims - Signed November 06, 2023

Invoices Received 10/30/2023-11/06/2023

<u>Date:</u>	<u>Claim #</u>	<u>Amount:</u>	<u>Payable To:</u>	<u>Description</u>
11/6/2023	EFT	1,296.19	Cardmember Services - VISA	CUM Fund Equipment- E22 Saw Blades; CUM Fund Station Reno- St22 Diffusers & Registers; CUM Fund PPE -Ballistics Vest
11/6/2023	EFT	984.77	Menard's	CUM Fund Station Reno - St22 & St25 Paint, Toe Kick, Storage Bins
11/6/2023	EFT	283.68	AT&T Mobility	Telephone - Mobile Phones (8)
11/6/2023	EFT	2,202.91	Cardmember Services - VISA	Contractual- Gsuite; Operating - Fire Watch Kits, Hydrant Bags, Wood; Computer Supp- Zoom, DropBox; Utilities- YouTubeTV (2); Fuel- R24; Postage- Meter; Legal Costs- BMV License; Training- WPE Supplies
11/6/2023	EFT	1,338.27	Gibson Teldata	Telephone - Phone System & Service
11/6/2023	EFT	909.49	Menard's	Vehicle Mnt- Fuel Premix; Operating- Station Supplies
11/6/2023	EFT	3,577.28	Sam's Club	Operating - Qrtly Station Supplies
11/6/2023	EFT	9,799.89	Standard Insurance	Life Insurance - LIFE ADD STD LTD
Total:		<u><u>\$ 20,392.48</u></u>		

NOTE:

Monroe Fire Protection District
Claims - Signed November 6, 2023

Invoices Received 9/21/2023-10/1/2023

<u>Date:</u>	<u>Claim #</u>	<u>Amount:</u>	<u>Payable To:</u>	<u>Description</u>
11/7/2023	1629	444.36	Donley	CUM Fund Equipment - Vulcan 180 Vehicle Mount BC22, C2-1
11/8/2023	8874	180.56	Amazon Capital Services	Operating - Label Maker Tape; Vehicle Mnt - Honda Carb E29, Heat Gun St39; Office Sup -
11/8/2023	8875	1,981.75	B-Tech	Parchment Paper (600)
11/8/2023	8876	855.94	Engraving, Awards & Gifts	Equipment Tests - Hydrostatic Testing of SCBA Bottle (59); Hydrostatic Testing & Annual Mnt
11/8/2023	8877	490.00	AED Professionals	Training - Custom Academy Plaque
				EMS Supplies - Quik Combo (10)

Total:

 \$ 3,952.61

NOTE: VOIDS

10/2/2023	1622	\$ 444.36	Donley	Checks Compromised - Account Closed 10/26/23
10/2/2023	8814	\$ 490.00	AED Professionals	Checks Compromised - Account Closed 10/26/23
10/2/2023	8815	\$ 180.56	Amazon Capital Services	Checks Compromised - Account Closed 10/26/23
10/2/2023	8816	\$ 1,981.75	B-Tech	Checks Compromised - Account Closed 10/26/23
10/2/2023	8817	\$ 855.94	Engraving, Awards & Gifts	Checks Compromised - Account Closed 10/26/23

Monroe Fire Protection District
Claims - Signed November 8, 2023

Invoices Received 10/29/2023-11/07/2023

<u>Date:</u>	<u>Claim #</u>	<u>Amount:</u>	<u>Payable To:</u>	<u>Description</u>
11/8/2023	1630	1,769.37	911 Fleet & Fire	CUM Fund PPE - Boots (4)
11/8/2023	1631	278.89	Amazon Capital Services	CUM Fund Station Renovations - Power Supply, Amp, Speakers, Shaker
11/8/2023	1632	3,300.00	Donley	CUM Fund Equipment - 5' Storz Couplings (4)
11/8/2023	EFT	25,221.96	ESO Solutions Inc	Contractual - ESO Software Annual 11/17-11/16/24 GAAP PrePay \$22,099.70
11/8/2023	8878	600.00	Advanced Rescue Solutions	Training - S Chapman
11/8/2023	8879	2,200.00	Alert-All	Promotional - EDITH Bracelets
				Vehicle Mnt - Snap tool kit St39; Driver side Mirror; Operating- Bristle Brush; Grill parts, Hoosier Flags; HVAC Filters; EMS Supp - Oximeters; Computer Supp - HDMI Cable; Antenna, Coax;
11/8/2023	8880	700.31	Amazon Capital Services	Med Services - Drug Test Cups
11/8/2023	8881	3,015.00	B-Tech	Equipment Tests & Certs - Water (10), ABC (1); Hydrostatic Testing (36)
11/8/2023	8882	166.32	B&B Water	Utilities - St24
11/8/2023	8883	83.31	Black Lumber	Operating - St22 Supplies
11/8/2023	8884	206.50	Commercial Service	Building Services - St29 Drain Blockage
11/8/2023	8885	175.00	Creative Products	Fire Prevention Ed Materials
11/8/2023	8886	348.19	Donley Safety	Equipment Mnt - St29 Repair Parts for Gated 'Y's
11/8/2023	8887	3,519.00	Eagle Engraving	Operating - Commendation Bars
				EMS Supplies - Gastric Access Kit (18), Penlights (24); Gastric Access (3); E26 Extrication Device, Megamover, Steth, Assure, O2, Bags, Collar; Ipratropium Bromide; C-Collar; Tape, BP Cuff(15) OB Kit (5), Steth (3)
11/8/2023	8888	2,158.68	Emergency Medical Products	Trustee Compensation - 3rd Quarter
11/8/2023	8889	891.00	Estate of C. Edward Brown	Telephone / Data - MDTs & Cellular Service (57)
11/8/2023	8890	1,844.59	FirstNet - ATT Mobility	Operating - TB Cleaner (60)
11/8/2023	8891	344.40	HB Warehouse - Resource Services	Vehicle Mnt - DEF (55ga)
11/8/2023	8892	220.57	Hawkins Bailey	Veh / Equipment Maintenance - Amkus Tools Prev Mnt
11/8/2023	8893	8,347.00	Hoosier Fire Equipment	Training - Membership Dues
11/8/2023	8894	925.00	IFCA - IN Fire Chiefs Association	Vehicle Mnt - MTZ-65 (1)
11/8/2023	8895	336.00	Interstate Battery Sys of Bloomington	Computer Supp - Antenna Mount (2), Mobile Antenna Mount (8) - Amb.
11/8/2023	8896	367.29	J&K Communications	Building Services - Top Soil St39
11/8/2023	8897	450.00	John Naylor Trucking	Vehicle Mnt - October Invoices (5)
11/8/2023	8898	253.51	Kleindorfers	Vehicle Mnt - INV 421-539911 R24 Fuel Filter (2)
11/8/2023	8899	121.97	NAPA Auto Parts	Equip Test & Certs - Hose Testing
11/8/2023	8900	11,127.45	Nichols Fire & Fleet	Accounting Services - Bookkeeping for October 2023
11/8/2023	8901	4,000.00	Root & Associates	Utilities - St21
11/8/2023	8902	286.66	Southern Monroe Water	Computer Support - HDV-B121H St22 HDMI Splitter
11/8/2023	8903	50.20	Stansifer Radio	Fuel - Wex not working
11/8/2023	8904	57.50	Coover, Steve	Operating - Lock Core, Long Tenon Fire Dept Only (100)
11/8/2023	8905	3,846.00	Knox	Vehicle Repair - E39 Alternator
11/8/2023	8906	2,431.98	Van's Electrical Systems	Utilities - St19, St23, St29
11/8/2023	8907	87.83	Van Buren Water	Utilities - St25, St25G
11/8/2023	8908	169.87	Washington Township Water	
Total:				
		\$ 79,901.35		

NOTE:

Monroe Fire Protection District
Claims - Signed November 17, 2023

Invoices Received 11/08/2023-11/16/2023

<u>Date:</u>	<u>Claim #</u>	<u>Amount:</u>	<u>Payable To:</u>	<u>Description</u>
11/17/2023	EFT	1,148.55	Lowe's	CUM Fund Misc EQ - 175PSI Compressor St22
11/17/2023	EFT	212.16	Lowe's	Operating - Station Supplies
11/17/2023	EFT	142.58	Centerpoint	Utilities - St21
11/17/2023	EFT	70.36	Centerpoint	Utilities - St22
11/17/2023	EFT	38.45	Centerpoint	Utilities - St24
11/17/2023	EFT	31.54	Centerpoint	Utilities - St24G
11/17/2023	EFT	145.23	Centerpoint	Utilities - St25
11/17/2023	EFT	17.98	Centerpoint	Utilities - St25G
11/17/2023	EFT	113.50	Centerpoint	Utilities - St29
11/17/2023	EFT	87.24	Duke Energy	Utilities - St25 AUTO PAY
11/17/2023	EFT	678.91	Duke Energy	Utilities - HQ AUTO PAY
11/17/2023	EFT	217.79	Duke Energy	Utilities - St25G AUTO PAY
11/17/2023	EFT	439.42	Duke Energy	Utilities - St22 AUTO PAY
11/17/2023	EFT	13.57	Express Waste Removal	Utilities - St22
11/17/2023	EFT	82.80	Express Waste Removal	Utilities - St29
11/17/2023	EFT	72.25	Express Waste Removal	Utilities - St21
11/17/2023	EFT	60.25	Express Waste Removal	Utilities - St23
11/17/2023	EFT	8.25	Express Waste Removal	Utilities - HQ
11/17/2023	EFT	6,225.29	Paramount Dental	Health Insurance - Group Dental
11/17/2023	EFT	10,106.27	WEX	Fuel - District Fuel; Vehicle Mnt - Oil Changes
11/17/2023	8911	125.00	Adam Branham	Building Services - Tinted Bay Door Window St22
11/17/2023	8912	1,389.79	Amazon Capital Services	Operating - Heating Element St23; Heat Gun; Clipboard (3); Bins, Wrench; Structural Collapse Unit 22; Credit Memo; Computer Supp - Timer Switch; Vehicle Mnt - Door Lock PV5; Office - 2024 Planners
11/17/2023	8913	383.93	Amazon Capital Services	Operating - Renfrew Tape; Charger; Case; Shower Caddy; Record Books; Office Supply - Note Pads, Highlighters, Binder Clips, Planners
11/17/2023	8914	5,906.77	Ascension St Vincent	Medical Services - Physicals
11/17/2023	8915	816.00	B-Tech	Building Services - Quarterly Monitoring; Equipment Tests & Certs - Hydro Test (11)
11/17/2023	8916	55.00	Bell's Exhaust	Vehicle Repair - Tailpipe Sq22
11/17/2023	8917	2,571.00	Bruce's Garage Doors	Building Services - Labor to repair St22 Bay Door; Garge Door and Labor St29; Replace Springs Garage Door St25
11/17/2023	8918	300.00	Chris Sites	Training - D Payne ACLS, PALS, PHTLS Provider & Card
11/17/2023	8919	349.58	City of Bloomington Utilities	Utilities - St22, HQ, St29
11/17/2023	8920	76.99	David Richards	Operating - Reimburse for paint
11/17/2023	8921	355.00	Economy Termite & Pest	Building Services - St22, HQ, St39, St19, St24, St21, St29
11/17/2023	8922	1,500.00	Fire Department Training Network	Training - J Hoffman Fall Live-Fire Training Camp
11/17/2023	8923	2,456.24	Fire Service Inc	Equipment Repair - TNT Repair Frieght only; Operating - Toolok (30); Vehicle Repair - Tool Service St 22 Spreaders Cutters Ram Combi
11/17/2023	8924	11.76	Gatehouse Media	Legal Advertising - 10/11 Board Meeting
11/17/2023	8925	3,787.50	Hartman & Williams	Accounting Services - Conversion of Financial Statements to GAAP - Aug & Sept
11/17/2023	8926	105.76	Jeff Combs	Training - Plan at National Fire Academy
11/17/2023	8927	34,730.00	Medical Necessities Corp	ARPA Ambulance & Chasis - Stryker 6390 Powerload System w/Floor Plates ARPA Grant
11/17/2023	8928	147.60	Midwest Natural Gas	Utilities - St39, St19
11/17/2023	8929	1,011.84	O'Reilly	Vehicle Mnt - October Invoices St39, TSU25, BC22, PV3, Br25
11/17/2023	8930	785.72	Orkin	Building Services - Pest Control Half month St25; Pest Control St25 Annual GAAP PrePay \$691.68
11/17/2023	8931	28.21	Pomp's Tire	Vehicle Repair - Left Rear Sq22
11/17/2023	8932	442.00	Pro Air Inc	Building Services - Line Valve Repair Kit, Knob, Gauge St21
11/17/2023	8933	1,549.49	REMC	Utilities St23, St29, St39
11/17/2023	8934	100.45	Republic Services	Utilities St19, St24
11/17/2023	8935	3,430.00	Sierra heating & Cooling	Building Services - Modline 125,000 btu Hanging Natural Gas Heater
11/17/2023	8936	37.20	South Central Regional Sewer	Utilities - St21
11/17/2023	8937	136.49	Tim Deckard	Vehicle Mnt - Oil Change WEX not working
11/17/2023	8938	509.45	WS Darley	Vehicle Mnt - Truck Charger
Total:		<u>\$ 83,011.16</u>		

NOTE:

Monroe Fire Protection District
Claims - Signed November 28, 2023

Invoices Received 11/17/2023-11/25/2023

<u>Date:</u>	<u>Claim #</u>	<u>Amount:</u>	<u>Payable To:</u>	<u>Description</u>
11/28/2023	EFT	1,679.98	Cardmember Services - VISA	CUM Fund Equipment - Garage Door Traffic Light; Hi-Side Truck Box (2)
11/28/2023	1700	3,158.00	WS Darley	CUM Fund Equipment - Thermal Imager Kit, Camera
11/28/2023	EFT	71.66	Van Buren Water	Utilities - St19, St23, St39
11/28/2023	EFT	1,265.32	Anthem Blue Cross	Health Insurance - Group Vision
11/28/2023	EFT	1,076.64	Comcast Business	Telephone / Data - District-wide Data
11/28/2023	EFT	88,888.74	IU Health Plans	Health Insurance - Group Medical
11/28/2023	EFT	635.93	Menards	Operating - Station Supplies
11/28/2023	EFT	1,366.70	Reliance Standard	Health Insurance - Group Critical Illness
11/28/2023	EFT	8,965.39	Standard Insurance	Life Insurance - Life ADD STD LTD
11/28/2023	EFT	4,570.14	AFLAC	Voluntary AFLAC - Employee Deductions
				Donation Fund - Pension Board Meal; Contractual - Google Ste; Computer Sup - GoDaddy, DropBox, Zoom; Utilities - YouTubeTV (2); Operating - Saws, Blades, Oil Dry, Batteries; Office Supplies - Image Saftware; Postage - Mailings to AFC & Alltest
11/28/2023	EFT	3,507.61	Cardmember Services - VISA	Health Insurance - H.S.A. Employer Contributions
11/28/2023	EFT	25,000.00	People's State Bank	Training - D Richards
11/28/2023	8940	600.00	Advanced Rescue Solutions	Office Supply - Security Envelopes (500); 2024 Planner (5); Canvas Record Book (1); Calendar; 2024 Planner (6); Operating - 2 Pack Replcmnt Battery for M-28V (5); Search & Rescue Supplies; Streamlight 140-Lumen (4) Apply Credit Memo (52.05); Brake Fluid;
11/28/2023	8941	1,756.94	Amazon Capital Services	Equipment Test & Certs - Air Flow Test (126) Facepiece Test (19)
11/28/2023	8942	3,272.74	Apparatus Service	Equipment Test & Certs - Annual Fire Exting Mnt Tags and Seals (27) & (18); Hydrostatic Testing SCBA (15) & (21)
11/28/2023	8943	1,650.57	B-Tech	Vehicle Repair - Torque Converter, Seal Assy, Trans Fluid C2-8; Seat Belt Assy Br29
11/28/2023	8944	3,772.35	Community Ford	Vehicle Mnt - Seat Valve Air Paddle L21 E21
11/28/2023	8945	97.98	Crossroads Truck Equipment	Legal Counsel - October Services, Agenda, Mtg, Vol Contract, St26
11/28/2023	8946	1,108.75	David Ferguson - Atty	kboard (2), Traction Device E26; Resus Pack (4) Pocket Mask; CPAP Set E26; Ambu Head Wedge (4); Suction Unit St81/St26
11/28/2023	8947	1,690.75	Emergency Medical Products	ARPA Ambulance & Chasis - Zoll X Series Defibrillator
11/28/2023	8948	19,895.00	Master Medical Equipment - MME	Special Chemical Supplies - Class A Foam
11/28/2023	8949	1,786.72	Nichols Fire & Fleet	Building Services - Line Valve Repair and Hose
11/28/2023	8950	267.00	ProAir Midwest, LLC	Building Services - Exhaust Fan Belt St25
11/28/2023	8951	153.00	Sierra Heating & Cooling	Utilities - St24
11/28/2023	8952	558.12	South Central REMC	
	Total:	<u>\$ 176,796.03</u>		
NOTE:				
11/30/2023	8939	-	Van Buren Water - VOID	Voided check to set up Auto-Pay

Monroe Fire Protection District

Financial Statements

November 30, 2023 and 2022

ACCOUNTANTS' REPORT

To the Management of:
Monroe Fire Protection District
3953 South Kennedy Drive
Bloomington, IN 47401-9619

The accompanying financial statements of Monroe Fire Protection District (a government entity) as of November 30, 2023 and 2022, were not subjected to an audit, review or compilation by us and accordingly, we do not express an opinion, a conclusion, nor provide assurance on them.



RootAdvisors LLC

December 04, 2023

Monroe Fire Protection District
Statement of Financial Position
As of November 30, 2023 and 2022

	Nov 30, 23	Nov 30, 22
ASSETS		
Current Assets		
Checking/Savings		
1029 · PSB - Restricted Donation Fund	324,880.00	0.00
1023 · Savings - PSB (Rainy Day)	675,113.82	172,365.11
1024 · Savings - Peoples - CUM Fund	1,098,712.84	693,233.22
1026 · Checking - Peoples	4,017,634.20	3,598,718.39
Total Checking/Savings	6,116,340.86	4,464,316.72
Total Current Assets	6,116,340.86	4,464,316.72
Fixed Assets		
2100 · Land	477,900.00	464,000.00
2200 · Building	6,563,986.26	6,474,868.10
2260 · Improvements Other Than Bldgs	93,739.00	93,739.00
2270 · Machinery & Equipment	2,215,773.74	2,209,458.74
2300 · Vehicles - Apparatus	9,702,595.26	8,962,595.26
2900 · Accumulated Depreciation	(10,187,082.12)	(9,854,602.58)
Total Fixed Assets	8,866,912.14	8,350,058.52
TOTAL ASSETS	14,983,253.00	12,814,375.24
LIABILITIES & EQUITY		
Liabilities		
Current Liabilities		
Other Current Liabilities		
3097 · Cincinnati Life Ins Payable	891.14	0.00
3098 · AFLAC Ins Payable	87.51	89.83
3050 · Fica & Federal Withheld	58,217.16	58,354.46
3070 · State & County Withheld	30,219.21	30,648.67
3090 · Pension Payable	28.40	0.00
Total Other Current Liabilities	89,443.42	89,092.96
Total Current Liabilities	89,443.42	89,092.96
Long Term Liabilities		
4000 · NP - Peoples State Bank - 4423	337,416.62	406,665.63
4020 · NP - Old National Bank	734,249.00	881,098.80
4050 · NP - PSB - E22 - 8106	490,796.84	604,866.00
Total Long Term Liabilities	1,562,462.46	1,892,630.43
Total Liabilities	1,651,905.88	1,981,723.39
Equity		
5010 · Fund Balance	14,595,198.72	11,356,367.29
Net Income	(1,263,851.60)	(523,715.44)
Total Equity	13,331,347.12	10,832,651.85
TOTAL LIABILITIES & EQUITY	14,983,253.00	12,814,375.24

No assurance is provided on these financial statements.

Monroe Fire Protection District
Statement of Activity - Annual Budget vs. Actual YTD
January through December 2023

	Jan - Dec 23	Budget	\$ Over Budget	% of Budget
Ordinary Income/Expense				
Income				
6010 · Monroe Co. Prop Tax Levy	5,030,237.09	8,676,669.00	(3,646,431.91)	58.0%
6160 · Local Income Tax (LIT) Cert Shs	3,248,491.75	3,520,778.00	(272,286.25)	92.3%
6110 · Vehicle/Aircraft Excise Tax	316,235.79	428,177.00	(111,941.21)	73.9%
6140 · CVET	5,672.29	10,700.00	(5,027.71)	53.0%
6180 · Fire Protection Contracts/Fees	213,306.00	240,904.00	(27,598.00)	88.5%
6030 · CUM Monroe Co. Prop Tax Levy	682,587.18	1,177,396.00	(494,808.82)	58.0%
6070 · Local Grant Income	1,595.00			
6111 · CUM Vehicle/Aircraft Excise Tax	42,912.20	60,000.00	(17,087.80)	71.5%
6141 · CUM CVET	769.71	1,300.00	(530.29)	59.2%
6190 · CUM Fire Protection Contr/Fees	15,000.00	18,000.00	(3,000.00)	83.3%
7010 · Federal Grant Reimbursement	859,046.63	1,276,204.00	(417,157.37)	67.3%
6300 · Donations	6,597.00			
6000 · Other Income	57,443.28			
9010 · Interest Income	3,644.01			
Total Income	10,483,537.93	15,410,128.00	(4,926,590.07)	68.0%
Expense				
PERSONAL SERVICES				
Salaries and Wages				
8212 · Salaries & Wages - Fire Chief	77,696.26	84,872.00	(7,175.74)	91.5%
8213 · Salaries & Wages - Deputy Chief	291,362.72	318,270.00	(26,907.28)	91.5%
8214 · Salaries & Wages - Asst Chief	200,858.49	222,789.00	(21,930.51)	90.2%
8215 · Salaries & Wages - Battalion Ch	347,165.83	413,751.00	(66,585.17)	83.9%
8216 · Salaries & Wages - Fire Marshal	63,128.67	68,959.00	(5,830.33)	91.5%
8217 · Salaries & Wages - Mechanic	80,445.40	68,959.00	11,486.40	116.7%
8218 · Salaries & Wages - Trng Captain	0.00			
8219 · Salaries & Wages - FF PERF Fund	629,689.64	700,194.00	(70,504.36)	89.9%
8220 · Salaries & Wages - FF 1977 Fund	3,445,727.61	3,946,548.00	(500,820.39)	87.3%
8221 · Salaries & Wages - Incentive	101,240.06	218,000.00	(116,759.94)	46.4%
8222 · Salaries & Wages - Officer Pay	290,416.72	385,000.00	(94,583.28)	75.4%
8223 · Salaries & Wages - Longevity	110,418.75	150,000.00	(39,581.25)	73.6%
8224 · Salaries & Wages - Holiday Pay	21,904.66	32,000.00	(10,095.34)	68.5%
8226 · Salaries & Wages - Part Time	677,420.82	800,000.00	(122,579.18)	84.7%
8227 · Salaries & Wages - Sub/Em/Tr/OT	380,137.15	527,000.00	(146,862.85)	72.1%
8228 · Salaries & Wages - Admin Assts	125,974.30	137,780.00	(11,805.70)	91.4%
8229 · Salaries & Wages - IT Spec	70,718.75	77,250.00	(6,531.25)	91.5%
8230 · Salaries & Wages - Trustee Comp	18,711.00	24,953.00	(6,242.00)	75.0%
8235 · Salaries & Wages - Uniform All	65,333.34	160,000.00	(94,666.66)	40.8%
Total Salaries and Wages	6,998,350.17	8,336,325.00	(1,337,974.83)	84.0%
Employee Benefits				
8240 · Social Security (Fica)	150,131.94	205,000.00	(54,868.06)	73.2%
8241 · Social Security (Medicare)	97,689.11	116,000.00	(18,310.89)	84.2%
8242 · State Unemployment Ins	16,698.44	35,000.00	(18,301.56)	47.7%
8243 · Employee Health AD&D Ins	1,225,620.84	1,810,900.00	(585,279.16)	67.7%
8244 · PERF 1977 Employer Contribution	778,289.45	1,156,383.00	(378,093.55)	67.3%
8245 · Life Insurance	109,712.64	130,000.00	(20,287.36)	84.4%
8246 · PERF Fund Employer Contribution	239,676.52	360,500.00	(120,823.48)	66.5%
Total Employee Benefits	2,617,818.94	3,813,783.00	(1,195,964.06)	68.6%
Other Personal Services				
8251 · Volunteer Fire Co Contract	(600.00)	75,000.00	(75,600.00)	(0.8)%
8252 · Length of Service Annuity	0.00	30,000.00	(30,000.00)	0.0%
8253 · Medical Services	98,826.67	115,647.28	(16,820.61)	85.5%
8254 · Early Retirement	50,000.00	50,000.00	0.00	100.0%
Total Other Personal Services	148,226.67	270,647.28	(122,420.61)	54.8%
Total PERSONAL SERVICES	9,764,395.78	12,420,755.28	(2,656,359.50)	78.6%
SUPPLIES				
8300 · Office Supplies	7,548.62	20,000.00	(12,451.38)	37.7%
8301 · Operating Supplies	94,498.19	131,500.00	(37,001.81)	71.9%
8302 · Vehicle Maintenance Supplies	87,170.14	100,000.00	(12,829.86)	87.2%
8303 · Promotional Supplies	9,027.24	12,000.00	(2,972.76)	75.2%
8304 · EMS Supplies	24,296.06	30,000.00	(5,703.94)	81.0%
8306 · IVFA Dues	1,935.00	3,500.00	(1,565.00)	55.3%
8308 · Fuel	109,305.91	150,000.00	(40,694.09)	72.9%

No assurance is provided on these financial statements.

Monroe Fire Protection District
Statement of Activity - Annual Budget vs. Actual YTD
January through December 2023

	Jan - Dec 23	Budget	\$ Over Budget	% of Budget
Other Supplies				
8311 · Special Chemical Supplies	1,892.29	5,000.00	(3,107.71)	37.8%
8312 · Fire Prevention Supplies	10,324.29	12,000.00	(1,675.71)	86.0%
8313 · Inspection/Investigation Supply	949.91	1,000.00	(50.09)	95.0%
8314 · Haz Mat Mitigation Supplies	3,424.37	10,000.00	(6,575.63)	34.2%
8315 · Color Guard Supplies	1,941.14	4,000.00	(2,058.86)	48.5%
Total Other Supplies	<u>18,532.00</u>	<u>32,000.00</u>	<u>(13,468.00)</u>	<u>57.9%</u>
Total SUPPLIES	352,313.16	479,000.00	(126,686.84)	73.6%
OTHER SERVICES & CHARGES				
Professional Services				
8351 · Seminars/Training	44,533.45	60,000.00	(15,466.55)	74.2%
8352 · Legal Counsel & Expenses	18,912.35	65,000.00	(46,087.65)	29.1%
8353 · Equipment Tests/Certifications	45,711.48	31,500.00	14,211.48	145.1%
8354 · Computer Support	29,855.03	51,481.90	(21,626.87)	58.0%
8355 · Accounting Services	52,775.00	55,000.00	(2,225.00)	96.0%
Total Professional Services	<u>191,787.31</u>	<u>262,981.90</u>	<u>(71,194.59)</u>	<u>72.9%</u>
Communication & Transportation				
8400 · Telephone Services	51,573.26	70,000.00	(18,426.74)	73.7%
8401 · Contractual Services	70,442.17	52,000.00	18,442.17	135.5%
8402 · Postage	565.37	3,000.00	(2,434.63)	18.8%
8403 · Travel Expenses	6,239.16	10,000.00	(3,760.84)	62.4%
Total Communication & Transportation	<u>128,819.96</u>	<u>135,000.00</u>	<u>(6,180.04)</u>	<u>95.4%</u>
Printing & Advertising				
8450 · Legal Advertising	126.91	1,500.00	(1,373.09)	8.5%
8451 · Printing	980.10	1,000.00	(19.90)	98.0%
Total Printing & Advertising	<u>1,107.01</u>	<u>2,500.00</u>	<u>(1,392.99)</u>	<u>44.3%</u>
Insurance				
8500 · General Liability Insurance	110,222.88	150,000.00	(39,777.12)	73.5%
8501 · Workmens Compensation	98,265.00	170,000.00	(71,735.00)	57.8%
Total Insurance	<u>208,487.88</u>	<u>320,000.00</u>	<u>(111,512.12)</u>	<u>65.2%</u>
Utility Service				
8550 · Utilities	95,362.51	150,000.00	(54,637.49)	63.6%
Total Utility Service	<u>95,362.51</u>	<u>150,000.00</u>	<u>(54,637.49)</u>	<u>63.6%</u>
Repairs & Maintenance				
8600 · Building Services	52,392.62	52,035.00	357.62	100.7%
8605 · Equipment & Vehicle Repairs	55,707.66	105,379.60	(49,671.94)	52.9%
Total Repairs & Maintenance	<u>108,100.28</u>	<u>157,414.60</u>	<u>(49,314.32)</u>	<u>68.7%</u>
Total OTHER SERVICES & CHARGES	<u>733,664.95</u>	<u>1,027,896.50</u>	<u>(294,231.55)</u>	<u>71.4%</u>
Total Expense	<u>10,850,373.89</u>	<u>13,927,651.78</u>	<u>(3,077,277.89)</u>	<u>77.9%</u>
Net Ordinary Income	(366,835.96)	1,482,476.22	(1,849,312.18)	(24.7)%
Other Income/Expense				
Other Expense				
8850 · Ambulance Chassis & Remount	467,970.92			
8440 · Meals & Awards	3,476.18			
8445 · Safe Haven Box Expenses	300.00			
8779 · CUM Fund - Small Vehicles	15,154.00	111,420.00	(96,266.00)	13.6%
8780 · CUM Fund - Misc/Eqpt/Cap Outlay	107,498.95	170,266.65	(62,767.70)	63.1%
8781 · CUM Fund - Pers Prot Eqpt (PPE)	46,310.03	116,000.00	(69,689.97)	39.9%
8782 · CUM Fund - Station 21 Mortgage	83,704.39	172,549.00	(88,844.61)	48.5%
8784 · CUM Fund - Bldg Renovations	108,180.99	120,000.00	(11,819.01)	90.2%
8785 · CUM Fund - Rescue 11(22)Replace	80,340.82	80,341.00	(0.18)	100.0%
8788 · CUM Fund - Engine 22	128,875.56	128,876.00	(0.44)	100.0%
8790 · CUM Fund-Apparatus Replacement	0.00	150,000.00	(150,000.00)	0.0%
Total Other Expense	<u>1,041,811.84</u>	<u>1,049,452.65</u>	<u>(7,640.81)</u>	<u>99.3%</u>
Net Other Income	<u>(1,041,811.84)</u>	<u>(1,049,452.65)</u>	<u>7,640.81</u>	<u>99.3%</u>
Net Income	<u>(1,408,647.80)</u>	<u>433,023.57</u>	<u>(1,841,671.37)</u>	<u>(325.3)%</u>

No assurance is provided on these financial statements.

Monroe Fire Protection District
Statement of Activity - Budget Performance

November 2023

	Nov 23	Budget	Jan - Nov 23	YTD Budget	Annual Budget
Ordinary Income/Expense					
Income					
6010 · Monroe Co. Prop Tax Levy	0.00	723,055.75	5,030,237.09	7,953,613.25	8,676,669.00
6160 · Local Income Tax (LIT) Cert Shs	292,781.25	293,398.17	3,248,491.75	3,227,379.83	3,520,778.00
6110 · Vehicle/Aircraft Excise Tax	0.00	35,681.42	316,235.79	392,495.58	428,177.00
6140 · CVET	0.00	891.67	5,672.29	9,808.33	10,700.00
6180 · Fire Protection Contracts/Fees	0.00	20,075.33	213,306.00	220,828.67	240,904.00
6030 · CUM Monroe Co. Prop Tax Levy	0.00	98,116.33	682,587.18	1,079,279.67	1,177,396.00
6070 · Local Grant Income	0.00		1,595.00		
6111 · CUM Vehicle/Aircraft Excise Tax	0.00	5,000.00	42,912.20	55,000.00	60,000.00
6141 · CUM CVET	0.00	108.33	769.71	1,191.67	1,300.00
6190 · CUM Fire Protection Contr/Fees	0.00	1,500.00	15,000.00	16,500.00	18,000.00
7010 · Federal Grant Reimbursement	0.00	106,350.33	859,046.63	1,169,853.67	1,276,204.00
6300 · Donations	520.00		6,597.00		
6000 · Other Income	4,235.00		57,443.28		
9010 · Interest Income	0.00		3,644.01		
Total Income	297,536.25	1,284,177.33	10,483,537.93	14,125,950.67	15,410,128.00
Expense					
PERSONAL SERVICES					
Salaries and Wages					
8212 · Salaries & Wages - Fire Chief	7,072.66	7,072.67	77,696.26	77,799.33	84,872.00
8213 · Salaries & Wages - Deputy Chief	26,522.64	26,522.50	291,362.72	291,747.50	318,270.00
8214 · Salaries & Wages - Asst Chief	18,565.74	18,565.75	200,858.49	204,223.25	222,789.00
8215 · Salaries & Wages - Battalion Ch	28,732.90	34,479.25	347,165.83	379,271.75	413,751.00
8216 · Salaries & Wages - Fire Marshal	5,746.58	5,746.58	63,128.67	63,212.42	68,959.00
8217 · Salaries & Wages - Mechanic	9,759.01	5,746.58	80,445.40	63,212.42	68,959.00
8218 · Salaries & Wages - Trng Captain	0.00		0.00		
8219 · Salaries & Wages - FF PERF Fund	81,079.14	58,349.50	629,689.64	641,844.50	700,194.00
8220 · Salaries & Wages - FF 1977 Fund	314,366.66	328,879.00	3,300,931.41	3,617,669.00	3,946,548.00
8221 · Salaries & Wages - Incentive	5,058.19	18,166.67	101,240.06	199,833.33	218,000.00
8222 · Salaries & Wages - Officer Pay	25,791.66	32,083.33	290,416.72	352,916.67	385,000.00
8223 · Salaries & Wages - Longevity	9,662.50	12,500.00	110,418.75	137,500.00	150,000.00
8224 · Salaries & Wages - Holiday Pay	2,400.16	2,666.67	21,904.66	29,333.33	32,000.00
8226 · Salaries & Wages - Part Time	57,313.25	66,666.67	677,420.82	733,333.33	800,000.00
8227 · Salaries & Wages - Sub/Em/Tr/OT	(29,857.37)	43,916.67	380,137.15	483,083.33	527,000.00
8228 · Salaries & Wages - Admin Assts	10,881.68	11,481.67	125,974.30	126,298.33	137,780.00
8229 · Salaries & Wages - IT Spec	6,437.50	6,437.50	70,718.75	70,812.50	77,250.00
8230 · Salaries & Wages - Trustee Comp	891.00	2,079.42	18,711.00	22,873.58	24,953.00
8235 · Salaries & Wages - Uniform All	0.00	13,333.33	65,333.34	146,666.67	160,000.00
Total Salaries and Wages	580,423.90	694,693.76	6,853,553.97	7,641,631.24	8,336,325.00
Employee Benefits					
8240 · Social Security (Fica)	12,812.12	17,083.33	150,131.94	187,916.67	205,000.00
8241 · Social Security (Medicare)	8,193.20	9,666.67	97,689.11	106,333.33	116,000.00
8242 · State Unemployment Ins	0.00	2,916.67	16,698.44	32,083.33	35,000.00
8243 · Employee Health AD&D Ins	117,635.68	150,908.33	1,225,620.84	1,659,991.67	1,810,900.00
8244 · PERF 1977 Employer Contribution	67,488.04	96,365.25	778,289.45	1,060,017.75	1,156,383.00
8245 · Life Insurance	18,765.28	10,833.33	109,712.64	119,166.67	130,000.00
8246 · PERF Fund Employer Contribution	20,469.36	30,041.67	239,676.52	330,458.33	360,500.00
Total Employee Benefits	245,363.68	317,815.25	2,617,818.94	3,495,967.75	3,813,783.00
Other Personal Services					
8251 · Volunteer Fire Co Contract	0.00	6,250.00	(600.00)	68,750.00	75,000.00
8252 · Length of Service Annuity	0.00	2,500.00	0.00	27,500.00	30,000.00
8253 · Medical Services	6,004.16	9,637.27	98,826.67	106,010.01	115,647.28
8254 · Early Retirement	0.00	4,166.67	50,000.00	45,833.33	50,000.00
Total Other Personal Services	6,004.16	22,553.94	148,226.67	248,093.34	270,647.28
Total PERSONAL SERVICES	831,791.74	1,035,062.95	9,619,599.58	11,385,692.33	12,420,755.28
SUPPLIES					
8300 · Office Supplies	387.68	1,666.67	7,548.62	18,333.33	20,000.00
8301 · Operating Supplies	22,359.47	10,958.33	94,498.19	120,541.67	131,500.00
8302 · Vehicle Maintenance Supplies	11,705.04	8,333.33	87,170.14	91,666.67	100,000.00
8303 · Promotional Supplies	2,200.00	1,000.00	9,027.24	11,000.00	12,000.00
8304 · EMS Supplies	4,425.05	2,500.00	24,296.06	27,500.00	30,000.00
8306 · IVFA Dues	0.00	291.67	1,935.00	3,208.33	3,500.00
8308 · Fuel	9,886.48	12,500.00	109,305.91	137,500.00	150,000.00

No assurance is provided on these financial statements.

Monroe Fire Protection District
Statement of Activity - Budget Performance

November 2023

	Nov 23	Budget	Jan - Nov 23	YTD Budget	Annual Budget
Other Supplies					
8311 · Special Chemical Supplies	1,786.72	416.67	1,892.29	4,583.33	5,000.00
8312 · Fire Prevention Supplies	175.00	1,000.00	10,324.29	11,000.00	12,000.00
8313 · Inspection/Investigation Supply	0.00	83.33	949.91	916.67	1,000.00
8314 · Haz Mat Mitigation Supplies	0.00	833.33	3,424.37	9,166.67	10,000.00
8315 · Color Guard Supplies	0.00	333.33	1,941.14	3,666.67	4,000.00
Total Other Supplies	<u>1,961.72</u>	<u>2,666.66</u>	<u>18,532.00</u>	<u>29,333.34</u>	<u>32,000.00</u>
Total SUPPLIES	52,925.44	39,916.66	352,313.16	439,083.34	479,000.00
OTHER SERVICES & CHARGES					
Professional Services					
8351 · Seminars/Training	4,180.71	5,000.00	44,533.45	55,000.00	60,000.00
8352 · Legal Counsel & Expenses	1,364.31	5,416.67	18,912.35	59,583.33	65,000.00
8353 · Equipment Tests/Certifications	19,395.76	2,625.00	45,711.48	28,875.00	31,500.00
8354 · Computer Support	1,028.36	4,290.16	29,855.03	47,191.74	51,481.90
8355 · Accounting Services	7,787.50	4,583.33	52,775.00	50,416.67	55,000.00
Total Professional Services	<u>33,756.64</u>	<u>21,915.16</u>	<u>191,787.31</u>	<u>241,066.74</u>	<u>262,981.90</u>
Communication & Transportation					
8400 · Telephone Services	4,543.18	5,833.33	51,573.26	64,166.67	70,000.00
8401 · Contractual Services	27,595.64	4,333.33	70,442.17	47,666.67	52,000.00
8402 · Postage	90.39	250.00	565.37	2,750.00	3,000.00
8403 · Travel Expenses	0.00	833.33	6,239.16	9,166.67	10,000.00
Total Communication & Transportation	<u>32,229.21</u>	<u>11,249.99</u>	<u>128,819.96</u>	<u>123,750.01</u>	<u>135,000.00</u>
Printing & Advertising					
8450 · Legal Advertising	11.76	125.00	126.91	1,375.00	1,500.00
8451 · Printing	0.00	83.33	980.10	916.67	1,000.00
Total Printing & Advertising	<u>11.76</u>	<u>208.33</u>	<u>1,107.01</u>	<u>2,291.67</u>	<u>2,500.00</u>
Insurance					
8500 · General Liability Insurance	0.00	12,500.00	110,222.88	137,500.00	150,000.00
8501 · Workmens Compensation	1,239.00	14,166.67	98,265.00	155,833.33	170,000.00
Total Insurance	<u>1,239.00</u>	<u>26,666.67</u>	<u>208,487.88</u>	<u>293,333.33</u>	<u>320,000.00</u>
Utility Service					
8550 · Utilities	6,036.86	12,500.00	95,362.51	137,500.00	150,000.00
Total Utility Service	<u>6,036.86</u>	<u>12,500.00</u>	<u>95,362.51</u>	<u>137,500.00</u>	<u>150,000.00</u>
Repairs & Maintenance					
8600 · Building Services	9,271.22	4,336.25	52,392.62	47,698.75	52,035.00
8605 · Equipment & Vehicle Repairs	7,809.03	8,781.63	55,707.66	96,597.97	105,379.60
Total Repairs & Maintenance	<u>17,080.25</u>	<u>13,117.88</u>	<u>108,100.28</u>	<u>144,296.72</u>	<u>157,414.60</u>
Total OTHER SERVICES & CHARGES	<u>90,353.72</u>	<u>85,658.03</u>	<u>733,664.95</u>	<u>942,238.47</u>	<u>1,027,896.50</u>
Total Expense	<u>975,070.90</u>	<u>1,160,637.64</u>	<u>10,705,577.69</u>	<u>12,767,014.14</u>	<u>13,927,651.78</u>
Net Ordinary Income	(677,534.65)	123,539.69	(222,039.76)	1,358,936.53	1,482,476.22
Other Income/Expense					
Other Expense					
8850 · Ambulance Chassis & Remount	54,625.00		467,970.92		
8440 · Meals & Awards	144.82		3,476.18		
8445 · Safe Haven Box Expenses	0.00		300.00		
8779 · CUM Fund - Small Vehicles	0.00	9,285.00	15,154.00	102,135.00	111,420.00
8780 · CUM Fund - Misc/Eqpt/Cap Outlay	9,963.63	14,188.89	107,498.95	156,077.76	170,266.65
8781 · CUM Fund - Pers Prot Eqpt (PPE)	(1,271.68)	9,666.67	46,310.03	106,333.33	116,000.00
8782 · CUM Fund - Station 21 Mortgage	0.00	14,379.08	83,704.39	158,169.92	172,549.00
8784 · CUM Fund - Bldg Renovations	2,002.91	10,000.00	108,180.99	110,000.00	120,000.00
8785 · CUM Fund - Rescue 11 (22) Replace	0.00	6,695.08	80,340.82	73,645.92	80,341.00
8788 · CUM Fund - Engine 22	0.00	10,739.67	128,875.56	118,136.33	128,876.00
8790 · CUM Fund-Apparatus Replacement	0.00	12,500.00	0.00	137,500.00	150,000.00
Total Other Expense	<u>65,464.68</u>	<u>87,454.39</u>	<u>1,041,811.84</u>	<u>961,998.26</u>	<u>1,049,452.65</u>
Net Other Income	<u>(65,464.68)</u>	<u>(87,454.39)</u>	<u>(1,041,811.84)</u>	<u>(961,998.26)</u>	<u>(1,049,452.65)</u>
Net Income	<u>(742,999.33)</u>	<u>36,085.30</u>	<u>(1,263,851.60)</u>	<u>396,938.27</u>	<u>433,023.57</u>

No assurance is provided on these financial statements.

Monroe Fire Protection District
Statement of Activity - YTD by fund
January through November 2023

	8603 - Special Fire General	8691 - Special CUM Fire	8840 - Donation Fund	8875 - Restricted Donation Fund
Ordinary Income/Expense				
Income				
6010 · Monroe Co. Prop Tax Levy	5,030,237.09	0.00	0.00	0.00
6160 · Local Income Tax (LIT) Cert Shs	3,248,491.75	0.00	0.00	0.00
6110 · Vehicle/Aircraft Excise Tax	316,235.79	0.00	0.00	0.00
6140 · CVET	5,672.29	0.00	0.00	0.00
6180 · Fire Protection Contracts/Fees	213,306.00	0.00	0.00	0.00
6030 · CUM Monroe Co. Prop Tax Levy	0.00	682,587.18	0.00	0.00
6070 · Local Grant Income	1,595.00	0.00	0.00	0.00
6111 · CUM Vehicle/Aircraft Excise Tax	0.00	42,912.20	0.00	0.00
6141 · CUM CVET	0.00	769.71	0.00	0.00
6190 · CUM Fire Protection Contr/Fees	0.00	15,000.00	0.00	0.00
7010 · Federal Grant Reimbursement	0.00	0.00	0.00	0.00
6300 · Donations	0.00	0.00	6,597.00	0.00
6000 · Other Income	38,051.86	19,391.42	0.00	0.00
9010 · Interest Income	0.00	0.00	0.00	1,124.00
Total Income	8,853,589.78	760,660.51	6,597.00	1,124.00
Expense				
PERSONAL SERVICES				
Salaries and Wages				
8212 · Salaries & Wages - Fire Chief	77,696.26	0.00	0.00	0.00
8213 · Salaries & Wages - Deputy Chief	291,362.72	0.00	0.00	0.00
8214 · Salaries & Wages - Asst Chief	200,858.49	0.00	0.00	0.00
8215 · Salaries & Wages - Battalion Ch	347,165.83	0.00	0.00	0.00
8216 · Salaries & Wages - Fire Marshal	63,128.67	0.00	0.00	0.00
8217 · Salaries & Wages - Mechanic	80,445.40	0.00	0.00	0.00
8218 · Salaries & Wages - Trng Captain	0.00	0.00	0.00	0.00
8219 · Salaries & Wages - FF PERF Fund	629,689.64	0.00	0.00	0.00
8220 · Salaries & Wages - FF 1977 Fund	3,300,931.41	0.00	0.00	0.00
8221 · Salaries & Wages - Incentive	101,240.06	0.00	0.00	0.00
8222 · Salaries & Wages - Officer Pay	290,416.72	0.00	0.00	0.00
8223 · Salaries & Wages - Longevity	110,418.75	0.00	0.00	0.00
8224 · Salaries & Wages - Holiday Pay	21,904.66	0.00	0.00	0.00
8226 · Salaries & Wages - Part Time	677,420.82	0.00	0.00	0.00
8227 · Salaries & Wages - Sub/Em/Tr/OT	380,137.15	0.00	0.00	0.00
8228 · Salaries & Wages - Admin Assts	125,974.30	0.00	0.00	0.00
8229 · Salaries & Wages - IT Spec	70,718.75	0.00	0.00	0.00
8230 · Salaries & Wages - Trustee Comp	18,711.00	0.00	0.00	0.00
8235 · Salaries & Wages - Uniform All	65,333.34	0.00	0.00	0.00
Total Salaries and Wages	6,853,553.97	0.00	0.00	0.00
Employee Benefits				
8240 · Social Security (Fica)	150,131.94	0.00	0.00	0.00
8241 · Social Security (Medicare)	97,689.11	0.00	0.00	0.00
8242 · State Unemployment Ins	16,698.44	0.00	0.00	0.00
8243 · Employee Health AD&D Ins	1,225,620.84	0.00	0.00	0.00
8244 · PERF 1977 Employer Contribution	778,289.45	0.00	0.00	0.00
8245 · Life Insurance	109,712.64	0.00	0.00	0.00
8246 · PERF Fund Employer Contribution	239,676.52	0.00	0.00	0.00
Total Employee Benefits	2,617,818.94	0.00	0.00	0.00
Other Personal Services				
8251 · Volunteer Fire Co Contract	-600.00	0.00	0.00	0.00
8253 · Medical Services	98,826.67	0.00	0.00	0.00
8254 · Early Retirement	50,000.00	0.00	0.00	0.00
Total Other Personal Services	148,226.67	0.00	0.00	0.00
Total PERSONAL SERVICES	9,619,599.58	0.00	0.00	0.00
SUPPLIES				
8300 · Office Supplies	7,548.62	0.00	0.00	0.00
8301 · Operating Supplies	72,693.39	0.00	0.00	0.00
8302 · Vehicle Maintenance Supplies	87,170.14	0.00	0.00	0.00
8303 · Promotional Supplies	9,027.24	0.00	0.00	0.00
8304 · EMS Supplies	24,296.06	0.00	0.00	0.00
8306 · IVFA Dues	1,935.00	0.00	0.00	0.00
8308 · Fuel	109,305.91	0.00	0.00	0.00
Other Supplies				
8311 · Special Chemical Supplies	1,892.29	0.00	0.00	0.00
8312 · Fire Prevention Supplies	10,324.29	0.00	0.00	0.00
8313 · Inspection/Investigation Supply	949.91	0.00	0.00	0.00
8314 · Haz Mat Mitigation Supplies	3,424.37	0.00	0.00	0.00
8315 · Color Guard Supplies	1,941.14	0.00	0.00	0.00
Total Other Supplies	18,532.00	0.00	0.00	0.00
Total SUPPLIES	330,508.36	0.00	0.00	0.00
OTHER SERVICES & CHARGES				
Professional Services				
8351 · Seminars/Training	44,533.45	0.00	0.00	0.00
8352 · Legal Counsel & Expenses	18,912.35	0.00	0.00	0.00
8353 · Equipment Tests/Certifications	45,711.48	0.00	0.00	0.00
8354 · Computer Support	29,855.03	0.00	0.00	0.00
8355 · Accounting Services	52,775.00	0.00	0.00	0.00
Total Professional Services	191,787.31	0.00	0.00	0.00
Communication & Transportation				
8400 · Telephone Services	51,573.26	0.00	0.00	0.00
8401 · Contractual Services	70,442.17	0.00	0.00	0.00
8402 · Postage	565.37	0.00	0.00	0.00
8403 · Travel Expenses	6,239.16	0.00	0.00	0.00
Total Communication & Transportation	128,819.96	0.00	0.00	0.00
Printing & Advertising				
8450 · Legal Advertising	126.91	0.00	0.00	0.00
8451 · Printing	980.10	0.00	0.00	0.00
Total Printing & Advertising	1,107.01	0.00	0.00	0.00

No assurance is provided on these financial statements.

Monroe Fire Protection District
Statement of Activity - YTD by fund
January through November 2023

	8603 - Special Fire General	8691 - Special CUM Fire	8840 - Donation Fund	8875 - Restricted Donation Fund
Insurance				
8500 · General Liability Insurance	110,222.88	0.00	0.00	0.00
8501 · Workmens Compensation	98,265.00	0.00	0.00	0.00
Total Insurance	208,487.88	0.00	0.00	0.00
Utility Service				
8550 · Utilities	95,362.51	0.00	0.00	0.00
Total Utility Service	95,362.51	0.00	0.00	0.00
Repairs & Maintenance				
8600 · Building Services	52,392.62	0.00	0.00	0.00
8605 · Equipment & Vehicle Repairs	55,707.66	0.00	0.00	0.00
Total Repairs & Maintenance	108,100.28	0.00	0.00	0.00
Total OTHER SERVICES & CHARGES	733,664.95	0.00	0.00	0.00
Total Expense	10,683,772.89	0.00	0.00	0.00
Net Ordinary Income	-1,830,183.11	760,660.51	6,597.00	1,124.00
Other Income/Expense				
Other Expense				
8850 · Ambulance Chassis & Remount	0.00	0.00	0.00	0.00
8440 · Meals & Awards	0.00	0.00	3,476.18	0.00
8445 · Safe Haven Box Expenses	0.00	0.00	300.00	0.00
8779 · CUM Fund - Small Vehicles	0.00	15,154.00	0.00	0.00
8780 · CUM Fund - Misc/Eqpt/Cap Outlay	0.00	107,498.95	0.00	0.00
8781 · CUM Fund - Pers Prot Eqpt (PPE)	0.00	41,310.03	0.00	0.00
8782 · CUM Fund - Station 21 Mortgage	0.00	83,704.39	0.00	0.00
8784 · CUM Fund - Bldg Renovations	0.00	108,180.99	0.00	0.00
8785 · CUM Fund - Rescue 11 (22)Replace	0.00	80,340.82	0.00	0.00
8788 · CUM Fund - Engine 22	0.00	128,875.56	0.00	0.00
Total Other Expense	0.00	565,064.74	3,776.18	0.00
Net Other Income	0.00	-565,064.74	-3,776.18	0.00
Net Income	-1,830,183.11	195,595.77	2,820.82	1,124.00

Monroe Fire Protection District
Statement of Activity - YTD by fund
January through November 2023

	8910 - FEMA RPA COVID19	8912 - AFG - W&F 97.044	8913 - AFG - 2022 Knox - 97.044	8919 - 2019 SAFER - 97.083
Ordinary Income/Expense				
Income				
6010 · Monroe Co. Prop Tax Levy	0.00		0.00	0.00
6160 · Local Income Tax (LIT) Cert Shs	0.00		0.00	0.00
6110 · Vehicle/Aircraft Excise Tax	0.00		0.00	0.00
6140 · CVET	0.00		0.00	0.00
6180 · Fire Protection Contracts/Fees	0.00		0.00	0.00
6030 · CUM Monroe Co. Prop Tax Levy	0.00		0.00	0.00
6070 · Local Grant Income	0.00		0.00	0.00
6111 · CUM Vehicle/Aircraft Excise Tax	0.00		0.00	0.00
6141 · CUM CVET	0.00		0.00	0.00
6190 · CUM Fire Protection Contr/Fees	0.00		0.00	0.00
7010 · Federal Grant Reimbursement	134,801.95	15,312.52	0.00	332,126.24
6300 · Donations	0.00	0.00	0.00	0.00
6000 · Other Income	0.00	0.00	0.00	0.00
9010 · Interest Income	0.00	0.00	0.00	0.00
Total Income	134,801.95	15,312.52	0.00	332,126.24
Expense				
PERSONAL SERVICES				
Salaries and Wages				
8212 · Salaries & Wages - Fire Chief	0.00	0.00	0.00	0.00
8213 · Salaries & Wages - Deputy Chief	0.00	0.00	0.00	0.00
8214 · Salaries & Wages - Asst Chief	0.00	0.00	0.00	0.00
8215 · Salaries & Wages - Battalion Ch	0.00	0.00	0.00	0.00
8216 · Salaries & Wages - Fire Marshal	0.00	0.00	0.00	0.00
8217 · Salaries & Wages - Mechanic	0.00	0.00	0.00	0.00
8218 · Salaries & Wages - Trng Captain	0.00	0.00	0.00	0.00
8219 · Salaries & Wages - FF PERF Fund	0.00	0.00	0.00	0.00
8220 · Salaries & Wages - FF 1977 Fund	0.00	0.00	0.00	0.00
8221 · Salaries & Wages - Incentive	0.00	0.00	0.00	0.00
8222 · Salaries & Wages - Officer Pay	0.00	0.00	0.00	0.00
8223 · Salaries & Wages - Longevity	0.00	0.00	0.00	0.00
8224 · Salaries & Wages - Holiday Pay	0.00	0.00	0.00	0.00
8226 · Salaries & Wages - Part Time	0.00	0.00	0.00	0.00
8227 · Salaries & Wages - Sub/Em/Tr/OT	0.00	0.00	0.00	0.00
8228 · Salaries & Wages - Admin AssTs	0.00	0.00	0.00	0.00
8229 · Salaries & Wages - IT Spec	0.00	0.00	0.00	0.00
8230 · Salaries & Wages - Trustee Comp	0.00	0.00	0.00	0.00
8235 · Salaries & Wages - Uniform All	0.00	0.00	0.00	0.00
Total Salaries and Wages	0.00	0.00	0.00	0.00
Employee Benefits				
8240 · Social Security (Fica)	0.00	0.00	0.00	0.00
8241 · Social Security (Medicare)	0.00	0.00	0.00	0.00
8242 · State Unemployment Ins	0.00	0.00	0.00	0.00
8243 · Employee Health AD&D Ins	0.00	0.00	0.00	0.00
8244 · PERF 1977 Employer Contribution	0.00	0.00	0.00	0.00
8245 · Life Insurance	0.00	0.00	0.00	0.00
8246 · PERF Fund Employer Contribution	0.00	0.00	0.00	0.00
Total Employee Benefits	0.00	0.00	0.00	0.00
Other Personal Services				
8251 · Volunteer Fire Co Contract	0.00	0.00	0.00	0.00
8253 · Medical Services	0.00	0.00	0.00	0.00
8254 · Early Retirement	0.00	0.00	0.00	0.00
Total Other Personal Services	0.00	0.00	0.00	0.00
Total PERSONAL SERVICES	0.00	0.00	0.00	0.00
SUPPLIES				
8300 · Office Supplies	0.00	0.00	0.00	0.00
8301 · Operating Supplies	0.00	17,958.80	3,846.00	0.00
8302 · Vehicle Maintenance Supplies	0.00	0.00	0.00	0.00
8303 · Promotional Supplies	0.00	0.00	0.00	0.00
8304 · EMS Supplies	0.00	0.00	0.00	0.00
8306 · IVFA Dues	0.00	0.00	0.00	0.00
8308 · Fuel	0.00	0.00	0.00	0.00
Other Supplies				
8311 · Special Chemical Supplies	0.00	0.00	0.00	0.00
8312 · Fire Prevention Supplies	0.00	0.00	0.00	0.00
8313 · Inspection/Investigation Supply	0.00	0.00	0.00	0.00
8314 · Haz Mat Mitigation Supplies	0.00	0.00	0.00	0.00
8315 · Color Guard Supplies	0.00	0.00	0.00	0.00
Total Other Supplies	0.00	0.00	0.00	0.00
Total SUPPLIES	0.00	17,958.80	3,846.00	0.00
OTHER SERVICES & CHARGES				
Professional Services				
8351 · Seminars/Training	0.00	0.00	0.00	0.00
8352 · Legal Counsel & Expenses	0.00	0.00	0.00	0.00
8353 · Equipment Tests/Certifications	0.00	0.00	0.00	0.00
8354 · Computer Support	0.00	0.00	0.00	0.00
8355 · Accounting Services	0.00	0.00	0.00	0.00
Total Professional Services	0.00	0.00	0.00	0.00
Communication & Transportation				
8400 · Telephone Services	0.00	0.00	0.00	0.00
8401 · Contractual Services	0.00	0.00	0.00	0.00
8402 · Postage	0.00	0.00	0.00	0.00
8403 · Travel Expenses	0.00	0.00	0.00	0.00
Total Communication & Transportation	0.00	0.00	0.00	0.00
Printing & Advertising				
8450 · Legal Advertising	0.00	0.00	0.00	0.00
8451 · Printing	0.00	0.00	0.00	0.00
Total Printing & Advertising	0.00	0.00	0.00	0.00

Monroe Fire Protection District
Statement of Activity - YTD by fund
January through November 2023

	8910 - FEMA RPA COVID19	8912 - AFG - W&F 97.044	8913 - AFG - 2022 Knox - 97.044	8919 - 2019 SAFER - 97.083
Insurance				
8500 · General Liability Insurance	0.00	0.00	0.00	0.00
8501 · Workmens Compensation	0.00	0.00	0.00	0.00
Total Insurance	0.00	0.00	0.00	0.00
Utility Service				
8550 · Utilities	0.00	0.00	0.00	0.00
Total Utility Service	0.00	0.00	0.00	0.00
Repairs & Maintenance				
8600 · Building Services	0.00	0.00	0.00	0.00
8605 · Equipment & Vehicle Repairs	0.00	0.00	0.00	0.00
Total Repairs & Maintenance	0.00	0.00	0.00	0.00
Total OTHER SERVICES & CHARGES	0.00	0.00	0.00	0.00
Total Expense	0.00	17,958.80	3,846.00	0.00
Net Ordinary Income	134,801.95	-2,646.28	-3,846.00	332,126.24
Other Income/Expense				
Other Expense				
8850 · Ambulance Chassis & Remount	0.00	0.00	0.00	0.00
8440 · Meals & Awards	0.00	0.00	0.00	0.00
8445 · Safe Haven Box Expenses	0.00	0.00	0.00	0.00
8779 · CUM Fund - Small Vehicles	0.00	0.00	0.00	0.00
8780 · CUM Fund - Misc/Eqpt/Cap Outlay	0.00	0.00	0.00	0.00
8781 · CUM Fund - Pers Prot Eqpt (PPE)	0.00	0.00	0.00	0.00
8782 · CUM Fund - Station 21 Mortgage	0.00	0.00	0.00	0.00
8784 · CUM Fund - Bldg Renovations	0.00	0.00	0.00	0.00
8785 · CUM Fund - Rescue 11 (22)Replace	0.00	0.00	0.00	0.00
8788 · CUM Fund - Engine 22	0.00	0.00	0.00	0.00
Total Other Expense	0.00	0.00	0.00	0.00
Net Other Income	0.00	0.00	0.00	0.00
Net Income	134,801.95	-2,646.28	-3,846.00	332,126.24

Monroe Fire Protection District
Statement of Activity - YTD by fund

January through November 2023

	8970 - VFA - DNR 10.698	8975 - ARPA 21.027	Rainy Day	TOTAL
Ordinary Income/Expense				
Income				
6010 · Monroe Co. Prop Tax Levy	0.00	0.00	0.00	5,030,237.09
6160 · Local Income Tax (LIT) Cert Shs	0.00	0.00	0.00	3,248,491.75
6110 · Vehicle/Aircraft Excise Tax	0.00	0.00	0.00	316,235.79
6140 · CVET	0.00	0.00	0.00	5,672.29
6180 · Fire Protection Contracts/Fees	0.00	0.00	0.00	213,306.00
6030 · CUM Monroe Co. Prop Tax Levy	0.00	0.00	0.00	682,587.18
6070 · Local Grant Income	0.00	0.00	0.00	1,595.00
6111 · CUM Vehicle/Aircraft Excise Tax	0.00	0.00	0.00	42,912.20
6141 · CUM CVET	0.00	0.00	0.00	769.71
6190 · CUM Fire Protection Contr/Fees	0.00	0.00	0.00	15,000.00
7010 · Federal Grant Reimbursement	5,000.00	371,805.92	0.00	859,046.63
6300 · Donations	0.00	0.00	0.00	6,597.00
6000 · Other Income	0.00	0.00	0.00	57,443.28
9010 · Interest Income	0.00	0.00	2,520.01	3,644.01
Total Income	5,000.00	371,805.92	2,520.01	10,483,537.93
Expense				
PERSONAL SERVICES				
Salaries and Wages				
8212 · Salaries & Wages - Fire Chief	0.00	0.00	0.00	77,696.26
8213 · Salaries & Wages - Deputy Chief	0.00	0.00	0.00	291,362.72
8214 · Salaries & Wages - Asst Chief	0.00	0.00	0.00	200,858.49
8215 · Salaries & Wages - Battalion Ch	0.00	0.00	0.00	347,165.83
8216 · Salaries & Wages - Fire Marshal	0.00	0.00	0.00	63,128.67
8217 · Salaries & Wages - Mechanic	0.00	0.00	0.00	80,445.40
8218 · Salaries & Wages - Trng Captain	0.00	0.00	0.00	0.00
8219 · Salaries & Wages - FF PERF Fund	0.00	0.00	0.00	629,689.64
8220 · Salaries & Wages - FF 1977 Fund	0.00	0.00	0.00	3,300,931.41
8221 · Salaries & Wages - Incentive	0.00	0.00	0.00	101,240.06
8222 · Salaries & Wages - Officer Pay	0.00	0.00	0.00	290,416.72
8223 · Salaries & Wages - Longevity	0.00	0.00	0.00	110,418.75
8224 · Salaries & Wages - Holiday Pay	0.00	0.00	0.00	21,904.66
8226 · Salaries & Wages - Part Time	0.00	0.00	0.00	677,420.82
8227 · Salaries & Wages - Sub/Em/Tr/OT	0.00	0.00	0.00	380,137.15
8228 · Salaries & Wages - Admin Assts	0.00	0.00	0.00	125,974.30
8229 · Salaries & Wages - IT Spec	0.00	0.00	0.00	70,718.75
8230 · Salaries & Wages - Trustee Comp	0.00	0.00	0.00	18,711.00
8235 · Salaries & Wages - Uniform All	0.00	0.00	0.00	65,333.34
Total Salaries and Wages	0.00	0.00	0.00	6,853,553.97
Employee Benefits				
8240 · Social Security (Fica)	0.00	0.00	0.00	150,131.94
8241 · Social Security (Medicare)	0.00	0.00	0.00	97,689.11
8242 · State Unemployment Ins	0.00	0.00	0.00	16,698.44
8243 · Employee Health AD&D Ins	0.00	0.00	0.00	1,225,620.84
8244 · PERF 1977 Employer Contribution	0.00	0.00	0.00	778,289.45
8245 · Life Insurance	0.00	0.00	0.00	109,712.64
8246 · PERF Fund Employer Contribution	0.00	0.00	0.00	239,676.52
Total Employee Benefits	0.00	0.00	0.00	2,617,818.94
Other Personal Services				
8251 · Volunteer Fire Co Contract	0.00	0.00	0.00	-600.00
8253 · Medical Services	0.00	0.00	0.00	98,826.67
8254 · Early Retirement	0.00	0.00	0.00	50,000.00
Total Other Personal Services	0.00	0.00	0.00	148,226.67
Total PERSONAL SERVICES	0.00	0.00	0.00	9,619,599.58
SUPPLIES				
8300 · Office Supplies	0.00	0.00	0.00	7,548.62
8301 · Operating Supplies	0.00	0.00	0.00	94,498.19
8302 · Vehicle Maintenance Supplies	0.00	0.00	0.00	87,170.14
8303 · Promotional Supplies	0.00	0.00	0.00	9,027.24
8304 · EMS Supplies	0.00	0.00	0.00	24,296.06
8306 · IVFA Dues	0.00	0.00	0.00	1,935.00
8308 · Fuel	0.00	0.00	0.00	109,305.91
Other Supplies				
8311 · Special Chemical Supplies	0.00	0.00	0.00	1,892.29
8312 · Fire Prevention Supplies	0.00	0.00	0.00	10,324.29
8313 · Inspection/Investigation Supply	0.00	0.00	0.00	949.91
8314 · Haz Mat Mitigation Supplies	0.00	0.00	0.00	3,424.37
8315 · Color Guard Supplies	0.00	0.00	0.00	1,941.14
Total Other Supplies	0.00	0.00	0.00	18,532.00
Total SUPPLIES	0.00	0.00	0.00	352,313.16
OTHER SERVICES & CHARGES				
Professional Services				
8351 · Seminars/Training	0.00	0.00	0.00	44,533.45
8352 · Legal Counsel & Expenses	0.00	0.00	0.00	18,912.35
8353 · Equipment Tests/Certifications	0.00	0.00	0.00	45,711.48
8354 · Computer Support	0.00	0.00	0.00	29,855.03
8355 · Accounting Services	0.00	0.00	0.00	52,775.00
Total Professional Services	0.00	0.00	0.00	191,787.31
Communication & Transportation				
8400 · Telephone Services	0.00	0.00	0.00	51,573.26
8401 · Contractual Services	0.00	0.00	0.00	70,442.17
8402 · Postage	0.00	0.00	0.00	565.37
8403 · Travel Expenses	0.00	0.00	0.00	6,239.16
Total Communication & Transportation	0.00	0.00	0.00	128,819.96
Printing & Advertising				
8450 · Legal Advertising	0.00	0.00	0.00	126.91
8451 · Printing	0.00	0.00	0.00	980.10
Total Printing & Advertising	0.00	0.00	0.00	1,107.01

Monroe Fire Protection District
Statement of Activity - YTD by fund
January through November 2023

	8970 - VFA - DNR 10.698	8975 - ARPA 21.027	Rainy Day	TOTAL
Insurance				
8500 · General Liability Insurance	0.00	0.00	0.00	110,222.88
8501 · Workmens Compensation	0.00	0.00	0.00	98,265.00
Total Insurance	0.00	0.00	0.00	208,487.88
Utility Service				
8550 · Utilities	0.00	0.00	0.00	95,362.51
Total Utility Service	0.00	0.00	0.00	95,362.51
Repairs & Maintenance				
8600 · Building Services	0.00	0.00	0.00	52,392.62
8605 · Equipment & Vehicle Repairs	0.00	0.00	0.00	55,707.66
Total Repairs & Maintenance	0.00	0.00	0.00	108,100.28
Total OTHER SERVICES & CHARGES	0.00	0.00	0.00	733,664.95
Total Expense	0.00	0.00	0.00	10,705,577.69
Net Ordinary Income	5,000.00	371,805.92	2,520.01	-222,039.76
Other Income/Expense				
Other Expense				
8850 · Ambulance Chassis & Remount	0.00	467,970.92	0.00	467,970.92
8440 · Meals & Awards	0.00	0.00	0.00	3,476.18
8445 · Safe Haven Box Expenses	0.00	0.00	0.00	300.00
8779 · CUM Fund - Small Vehicles	0.00	0.00	0.00	15,154.00
8780 · CUM Fund - Misc/Eqpt/Cap Outlay	0.00	0.00	0.00	107,498.95
8781 · CUM Fund - Pers Prot Eqpt (PPE)	5,000.00	0.00	0.00	46,310.03
8782 · CUM Fund - Station 21 Mortgage	0.00	0.00	0.00	83,704.39
8784 · CUM Fund - Bldg Renovations	0.00	0.00	0.00	108,180.99
8785 · CUM Fund - Rescue 11 (22)Replace	0.00	0.00	0.00	80,340.82
8788 · CUM Fund - Engine 22	0.00	0.00	0.00	128,875.56
Total Other Expense	5,000.00	467,970.92	0.00	1,041,811.84
Net Other Income	-5,000.00	-467,970.92	0.00	-1,041,811.84
Net Income	0.00	-96,165.00	2,520.01	-1,263,851.60

Special Fire General - Fund 8603		Adjusted Budget	Current Month Expenditures	YTD Expenditures	% Expended	Balance Remaining
			<i>Change fx</i>		92.0%	
Personal Services						
8212	Fire Chief	\$ 84,872.00	7,072.66	\$ 77,696.26	91.5%	\$ 7,175.74
8213	Deputy Chief (4)	\$ 318,270.00	26,522.64	\$ 291,362.72	91.5%	\$ 26,907.28
8214	Assistant Chief (3)	\$ 222,789.00	18,565.74	\$ 200,858.49	90.2%	\$ 21,930.51
8215	Battalion Chief (6)	\$ 413,751.00	28,732.90	\$ 347,165.83	83.9%	\$ 66,585.17
8216	Fire Marshal	\$ 68,959.00	5,746.58	\$ 63,128.67	91.5%	\$ 5,830.33
8217	Mechanic	\$ 68,959.00	9,759.01	\$ 80,445.40	116.7%	\$ (11,486.40)
8219	Firefighters Salary - PERF Fund	\$ 700,194.00	81,079.14	\$ 629,689.64	89.9%	\$ 70,504.36
8220	Firefighters Salary - 1977 Fund	\$ 3,946,548.00	314,366.66	\$ 3,300,931.41	83.6%	\$ 645,616.59
8221	Incentive Qualifications	\$ 218,000.00	5,058.19	\$ 156,631.74	71.8%	\$ 61,368.26
8222	Officer Pay	\$ 385,000.00	25,791.66	\$ 290,416.72	75.4%	\$ 94,583.28
8223	Longevity	\$ 150,000.00	9,662.50	\$ 110,418.75	73.6%	\$ 39,581.25
8224	Holiday Pay	\$ 32,000.00	2,400.16	\$ 21,904.66	68.5%	\$ 10,095.34
8226	Part-Time Employees	\$ 800,000.00	57,313.25	\$ 677,420.82	84.7%	\$ 122,579.18
8227	Substitute, Emergency, Overtime, Trng	\$ 527,000.00	(29,857.37)	\$ 437,263.15	83.0%	\$ 89,736.85
8228	Administrative Assistant (2)	\$ 137,780.00	10,881.68	\$ 125,974.30	91.4%	\$ 11,805.70
8229	IT Specialist	\$ 77,250.00	6,437.50	\$ 70,718.75	91.5%	\$ 6,531.25
8230	Trustee Compensation (7)	\$ 24,953.00	891.00	\$ 18,711.00	75.0%	\$ 6,242.00
8235	Uniform Allowance	\$ 160,000.00	-	\$ 127,500.02	79.7%	\$ 32,499.98
8240	Social Security	\$ 205,000.00	12,812.12	\$ 150,131.94	73.2%	\$ 54,868.06
8241	Medicare	\$ 116,000.00	8,193.20	\$ 97,689.11	84.2%	\$ 18,310.89
8242	Unemployment Insurance	\$ 35,000.00	-	\$ 16,698.44	47.7%	\$ 18,301.56
8243	Health Insurance (M/D/V/CI)	\$ 1,810,900.00	117,635.68	\$ 1,225,620.84	67.7%	\$ 585,279.16
8244	PERF 1977 Employer Contribution	\$ 1,156,383.00	67,488.04	\$ 778,289.45	67.3%	\$ 378,093.55
8245	Life Insurance (Life/ADD/STD/LTD)	\$ 130,000.00	18,765.28	\$ 109,712.64	84.4%	\$ 20,287.36
8246	PERF Fund Employer Contribution	\$ 360,500.00	20,469.36	\$ 239,676.52	66.5%	\$ 120,823.48
8251	Volunteer Contract	\$ 75,000.00	-	\$ (600.00)	-0.8%	\$ 75,600.00
8252	Length of Service	\$ 30,000.00	-	\$ -	0.0%	\$ 30,000.00
8253	Medical Services	\$ 115,647.28	6,004.16	\$ 98,826.67	85.5%	\$ 16,820.61
8254	Early Retirement	\$ 50,000.00	-	\$ 50,000.00	100.0%	\$ -
		\$ 12,420,755.28	\$ 831,791.74	\$ 9,794,283.94	78.9%	\$ 2,626,471.34
Supplies						
8300	Office Supplies	\$ 20,000.00	387.68	\$ 7,548.62	37.7%	\$ 12,451.38
8301	Operating Supplies	\$ 131,500.00	22,359.47	\$ 94,498.19	71.9%	\$ 37,001.81
8302	Vehicle Maintenance Supplies	\$ 100,000.00	11,705.04	\$ 87,170.14	87.2%	\$ 12,829.86
8303	Promotional Supplies	\$ 12,000.00	2,200.00	\$ 9,027.24	75.2%	\$ 2,972.76
8304	EMS Supplies	\$ 30,000.00	4,425.05	\$ 24,296.06	81.0%	\$ 5,703.94
8306	IVFA Dues	\$ 3,500.00	-	\$ 1,935.00	55.3%	\$ 1,565.00
8308	Fuel	\$ 150,000.00	9,886.48	\$ 109,305.91	72.9%	\$ 40,694.09
8311	Special Chemical Supplies	\$ 5,000.00	1,786.72	\$ 1,892.29	37.8%	\$ 3,107.71
8312	Fire Prevention Education Supplies	\$ 12,000.00	175.00	\$ 10,324.29	86.0%	\$ 1,675.71
8313	Inspection/Investigation Supplies	\$ 1,000.00	-	\$ 949.91	95.0%	\$ 50.09
8314	Hazardous Materials Mitigation	\$ 10,000.00	-	\$ 3,424.37	34.2%	\$ 6,575.63
8315	Color Guard Supplies	\$ 4,000.00	-	\$ 1,941.14	48.5%	\$ 2,058.86
		\$ 479,000.00	\$ 52,925.44	\$ 352,313.16	73.6%	\$ 126,686.84
Services & Charges						
8351	Seminars/Training	\$ 60,000.00	4,180.71	\$ 44,533.45	74.2%	\$ 15,466.55
8352	Legal Counsel & Expenses	\$ 65,000.00	1,364.31	\$ 18,912.35	29.1%	\$ 46,087.65
8353	Equipment Tests/Certifications	\$ 31,500.00	19,395.76	\$ 45,711.48	145.1%	\$ (14,211.48)
8354	Computer Technical Support	\$ 51,481.90	1,028.36	\$ 29,855.03	58.0%	\$ 21,626.87
8355	Accounting Services	\$ 55,000.00	7,787.50	\$ 52,775.00	96.0%	\$ 2,225.00
8400	Telephone & Data Services	\$ 70,000.00	4,543.18	\$ 51,573.26	73.7%	\$ 18,426.74
8401	Contractual Services	\$ 52,000.00	27,595.64	\$ 70,442.17	135.5%	\$ (18,442.17)
8402	Postage & Fees	\$ 3,000.00	90.39	\$ 565.37	18.8%	\$ 2,434.63
8403	Travel Expenses	\$ 10,000.00	-	\$ 6,239.16	62.4%	\$ 3,760.84
8450	Legal Advertising	\$ 1,500.00	11.76	\$ 126.91	8.5%	\$ 1,373.09
8451	Printing	\$ 1,000.00	-	\$ 980.10	98.0%	\$ 19.90
8500	General Insurance	\$ 150,000.00	-	\$ 110,222.88	73.5%	\$ 39,777.12
8501	Worker's Compensation Insurance	\$ 170,000.00	1,239.00	\$ 98,265.00	57.8%	\$ 71,735.00
8550	Utilities	\$ 150,000.00	6,036.86	\$ 95,362.51	63.6%	\$ 54,637.49
8600	Building Services	\$ 52,035.00	9,271.22	\$ 52,392.62	100.7%	\$ (357.62)
8605	Equipment & Vehicle Repairs	\$ 105,379.60	7,809.03	\$ 55,707.66	52.9%	\$ 49,671.94
		\$ 1,027,896.50	\$ 90,353.72	\$ 733,664.95	71.4%	\$ 294,231.55
		\$ 13,927,651.78	\$ 975,070.90	\$ 10,880,262.05	78.1%	\$ 3,047,389.73

General Fund Cash Balance \$ 4,017,634.20

Special CUM Fire - Fund 8691		Adjusted Budget	Current Month Expenditures	YTD Expenditures	% Expended	Balance Remaining
					92.0%	
Capital Outlays						
8779	Small Vehicles	\$ 111,420.00	-	\$ 15,154.00	13.6%	\$ 96,266.00
8780	Misc, Equipment & Capital Outlays	\$ 170,266.65	9,963.63	\$ 107,498.95	63.1%	\$ 62,767.70
8781	Personal Protective Equipment (PPE)	\$ 116,000.00	(1,271.68)	\$ 46,310.03	39.9%	\$ 69,689.97
8782	Station 21 Mortgage	\$ 172,549.00	-	\$ 83,704.39	48.5%	\$ 88,844.61
8784	Building Renovations	\$ 120,000.00	2,002.91	\$ 108,180.99	90.2%	\$ 11,819.01
8785	Rescue 11 (22) Replacement	\$ 80,341.00	-	\$ 80,340.82	100.0%	\$ 0.18
8788	Engine 22	\$ 128,876.00	-	\$ 128,875.56	100.0%	\$ 0.44
8790	Apparatus Replacement	\$ 150,000.00	-	\$ -	0.0%	\$ 150,000.00
		\$ 1,049,452.65	\$ 10,694.86	\$ 570,064.74	54%	\$ 479,387.91

CUM Fund Cash Balance \$ 1,098,712.84

Rainy Day Cash Balance \$ 675,113.82

Restricted Donation \$ 324,880.00