

# FPGA Implementation Of Advanced Algorithm For Reduction Of False Triggering In The Background Identification circuit using Gaussian Mixture Model.

Manu K.S\*, Dr. Rekha K.R\*\*, Dr . Nataraj K.R\*\*\*

Research Scholar SSAHE, Department Of ECE SJBIT, Department Of ECE SJBIT  
Tumkur Karnataka India, Bangalore Karnataka India, Bangalore Karnataka India  
[ksmanu86@gmail.com](mailto:ksmanu86@gmail.com), [krrekha@sjbit.edu.in](mailto:krrekha@sjbit.edu.in), [Krnataraj@sjbit.edu.in](mailto:Krnataraj@sjbit.edu.in)

**Abstract** – Outstanding demand for the video/image processing on hardware FPGA implementation of various image processing algorithm has become a need. Lot of research work is being completed in the field of image processing and video processing on FPGA. Identification and recognition of an object and tracking its movement is highly difficult in the field of computer based vision and image processing system. In this paper we specifically concentrate on working Background identification (Bg), moving object detection and tracking which helps in reduction of false triggering, with support from the survey report and the previous work done in this area we have particularly selected the Gaussian mixture model for the implementation. The paper PROPOSES about three block of implementation on FPGA, mainly the image block generation and the RGB to YCbCr IMAGE conversion and optimized background identification and updating unit been implemented for the application in real time image. It has been observed based on the simulation results and the synthesis outcome. The proposed design in this paper is capable of obtaining good results in terms of resolution for all the standard input image frame of size 1920 x 1080. The overall utilization of the block implemented in design is very less and is only about 15% of the total area on the latest Atrix7 series of FPGA from Xilinx. The design is comparatively faster with processing time of only 20ns for each fram of the mentioned size.

**Keywords** – Image Processing (IP), Field Programmable Gate Array (FPGA), Gaussian Mixture Model (GMM), Color Space Conversion, Memory element.

## 1. INTRODUCTION

Now a days intelligent and intellectual surveillance system is one of the most demanded system, due to HIGH rise in

demand for the better security. These surveillance systems mainly work on moving object detection and tracking in a given REALTIME video stream. It has become a BIG challenge to develop a real-time implementation of moving object detection and recognition algorithm to reduce the time and improve the efficiency of the system. Usually moving object detection and tracking done on video that uses a intensity of visible light image sensor (in terms of gray value) and sometime based on thermal infrared based sensors. Once the video is available then the image processing algorithm is applied on the targeted video to extract various features such as mean, standard deviation, skewness and kurtosis factors in the given stream of video. Features also like motion parameters, which includes position of the target object, velocity of the moving object (which helps in increase contrast of an image). Basically moving real time object identification and tracking are two process which are very closely related to each other. Hence, they can share most of the common features achieved from the image processing algorithm.

In additional, we can also share motion analysis with other image processing algorithms/methods, namely pattern recognition, computer vision, artificial intelligence and similar implementation. It is very challenging and interesting to extract the features of real time object and do the segmentation in the provided video for fast moving objects. In this paper, we have proposed a system which generates the 3 x 3 overlapping block image from the given input image for the processing of the data. This design comprises of memory element which stores the data and produces in future process as per the requirement. The design is made for 3 x 3 image to reduce the design complexity and increase the computational speed due to less data. However it can be done for other size of an image. Keeping in mind, it's easy to deal with grayscale image, our design also proposes a simple design for color space conversion of the input image which converts the given RGB image to YCbCr image.

The enormous demand for image segmentation in high speed video for an moving object with dynamic scenes has thrown a lot of challenges for the designers. The fast background scene modeling for real time visual surveillance system to track people in an outdoor environment. It operates on grayscale video imagery, or on video imagery from an infrared camera [1]. This system learns and models background scene, statistically to detect foreground objects, even when the background is not completely stationary (e.g. motion of tree branches) using shape and motion cues. Variety of probabilistic models are designed for tracking small-area targets which are common objects of interest in outdoor application and the difficult of using appearance and motion models in classifying and tracking objects when detailed information of the object's appearance is not available[2]. This approach uses a robust background to segment moving objects with very low false detection rates. This system also includes a shadow detection algorithm which helps alleviate standard environmental problems related with such approaches. An image processing and objects tracking of a video-based freeway traffic monitoring system estimates the traffic speed in different lanes of a freeway allows for timely detection of possible congestions [3]. This method consists of a road modeling stage and a vehicle tracking stage. Initially a 3D model of the background (Bg) road image is generated using multiple initial frames. And then each car in the scene is isolated and tracked over many frames, and by mapping its spatial coordinates to the road's 3D model to estimate the velocity of an car on the road. A Kalman filter is used for a constant value in the measurement uncertainty to smooth the result. The algorithm with Kalman filter is tested extensively using a sequence took from tower overlooking a vehicular intersection which helps in solving the problem of detecting the trajectories of moving vehicles this method is based on the spatial-temporal connectivity analysis, to extract the vehicles trajectories from temporal templates, spanned over a short period of time. Temporal templates are adapted with the successive images difference[4] improved version of an algorithm on frame difference and edge detects the edges of each two successive frames by Canny detector and gets the resultant image (difference between the two edge images)[5]. And then, it divides the resultant image into several small blocks of sub images and decides whether the sub images are moving by comparing the number of non-zero pixels to a threshold pixel values. Finally, it does the block-connected component labeling to get the smallest rectangle area (subimage) that contains the moving object. Recognition of an object after finding the motion object is done with the help of frame difference algorithm and features were extracted from moving object region. Later vector standardization was

done for these moment invariant features, then wavelet neural network with genetic algorithm is uses for pattern recognition [7]. A new approach is taken into account for changing illumination should be considered in the background estimation, and should not be detected as foreground [9]. This new approach assumes stationary cameras with fixed focal Length and considers non-rigid objects moving non-continuously. Statistical model are used to overcome the problems caused by shadow borders and the adaptation in a real-time application, when the background is covered by the foreground. Later, modeling of an each pixel as a mixture of Gaussians distribution and using an on-line approximation model to update the exiting model. The Gaussian, distributions of the adaptive mixture model is then evaluated to determine efficient background process image [11]. Each pixel is classified based on the pixel values distributed as Gaussian distribution which represents it most effectively is considered part of the background model. The resultant images are stable, real-time outdoor tracker which reliably deals with lighting changes, repetitive motions from clutter, and long-term scene changes. The classification of the data from the main input is one of our main target to be achieved. The best method of classification of the object of interest has been discussed in [9, 12] where we get the clear picture of classification of an image.

In this paper there are mainly two main difficulties one is coupling of input data for next process to processing element. The challenge is that the number of bits to represent the input image is too high and all of it has to be processed in the given stipulated time only. It may cause delay, many cause the system to malfunction. Second biggest challenge is about the motion detection / recognition and tracing / tracking for the data in complex background. Several experiments and analysis related to our work has been carried out on performance evaluation of the used algorithm such as Mean Shift based moving object detection etc. considering all the disadvantages and advantages of the previous algorithms which are related to my work, an efficient model of an updated algorithm has been proposed in the paper which has got capabilities of improving the performance of the system by reducing false triggering.

The utilization of Gaussian Mixture Model (GMM) is the biggest advantage since it has an efficient method to work with multimodal background based on statistical model to be composed of Gaussian distribution. The GMM is very suitable model and works as a significant component in many design so it has been modified and updated in Open CV libraries. Below shows the basic block diagram for the GMM model of our design.

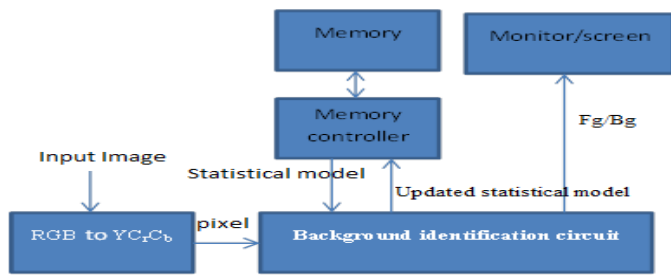

Figure 1. Block diagram for proposed GMM

The proposed block is as shown in the above figure 1, the above diagram is categorized into three main components in GMM, 1) the real-time input image/video acquisition and the interface along with color space conversion. 2) Background identification module/circuit, this is the heart of the research work. The new algorithm for detection and tracking is implemented in this block and is used for the final decision making in terms of object detection and tracking. 3) Third main component in the block diagram is external interfaces with display units such as monitor/screen and different types of memory elements. This paper is organized as follows. Section 2 gives a generation of 3 x 3 block and the block conversion of RGB to YCbCr. Section 3 presents the implementation of background identification module. Section 4 presents the ANN implementation. Simulation and synthesis results and the comparison with other work are explained in section 5. Conclusion and future work is given in section 6.

## II. BLOCK GENERATION UNIT

Initially, the real-time image is captured for which our design is implemented. The design is implemented on MATLAB and Xilinx for checking the functionality of the GMM algorithm on the given input data. The design is coded in MATLAB for the standard conversion of data matrix in 1D. Here the complete image is converted into 256 x 256 image. This is in the form of gray scale image. It means the entire image is varied in the form of white and black color with different ranges of intensity values. Where, each pixel assigns a value of corresponding intensity value.

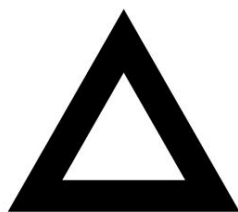

Figure 2: input image

Above figure 2 is used as an input for design. If the image is RGB then image is converted into chromatic image with a size of 256 x 256. With the help of MATLAB, text document is created which contains hexadecimal values of each pixel with the help of Xilinx, again new file is created, which contains the pixel values of overlapped resultant image. The resultant image is also 256 x 256. There may be a chance of high impedance values also created and these values are removed before generating the resultant overlapped image when executed in supported with MATLAB. The resultant image is as shown in figure 3.

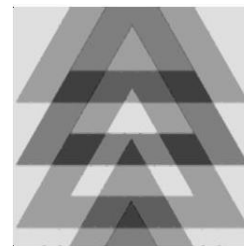

Figure 3. Output image

The main consideration has been taken initially, for a generation of 3 x 3 memory element block for the further processing of the image. The memory RAM block is incorporated of size 776 locations, where each location has 8-bit resolution pixel values. Data of an 8-bit input image which is represented in serial format enters the register as a temporary data and is passed into the memory element. Below block diagram shows the generation of 3 x 3 blocks.

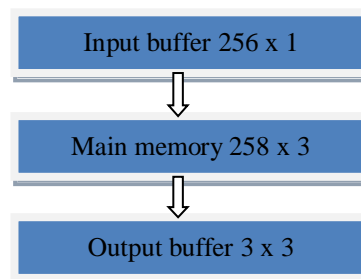

Figure 4: block diagram of block generation unit

Figure 4 shows the basic block diagram of block generation unit. The design is implemented in such a manner that it is quite well-organized in generation of 3 x 3 block with the minutest usage of the memory.

## III. BACKGROUND IDENTIFICATION CIRCUIT

Background identification module plays the superior role in design. Figure 1 block diagram shows the conceptual view of

a background identification system. A camera captures each frame of the realtime video sequence and its interface gives the pixel intensity values to the Bg identification circuit. The Bg identification circuit studies and processes the luminance value of each input Pixel and the Statistical Model of the pixel for the given or nth real time image. The output computed pixel values and extracted parameters data are update the Statistical Model for future process.

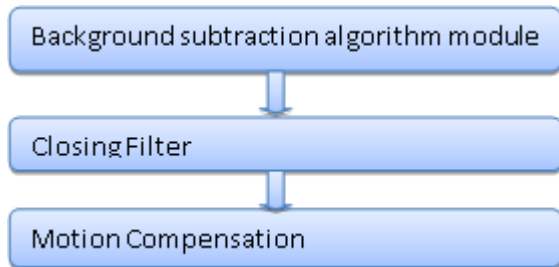

Figure 6: sub modules of background identification circuit.

For each input pixel, the Gaussian parameters mean standard deviation and variance are read from an external memory and the updated parameters are stored in the memory for future process. This circuit is implemented to avoid the false triggering in the cctv applications and it updates the background memory with the help of memory supervisor. This model can be analyzed by step by step processing the sub-modules of Bg circuit as shown in the fig 6.

IV. PROPOSED MATHEMATICAL FORMULATION FOR THE BACKGROUND IDENTIFICATION CIRCUIT.

Consider the kth frame of the real time video as Input, such that  $I(i, j)$  represents the intensity value of the pixel which is located at  $i$ th row and  $j$ th column of  $k$ th frame. Consider for each such pixels value in a complete realtime image of queue  $Q(i, j)$  of size  $N$ , the total sum of pixel values is  $S(i, j)$  and average of pixel values  $A(i, j)$  is retained over the incoming frames. The total number of 8 bit real time image frames  $N$  is considered for modeling of static background can be selected as per the user requirement. It is directly related to the amount of time elapsed until the object is declared as abandoned.

**Background subtraction module:** the reference Background Image pixel value and Current real time frame pixel value are consider as the inputs to this module. These two data is processed to get the object which is in motion compared with the background image. Table 1 shows the working process table of the background subtraction module.

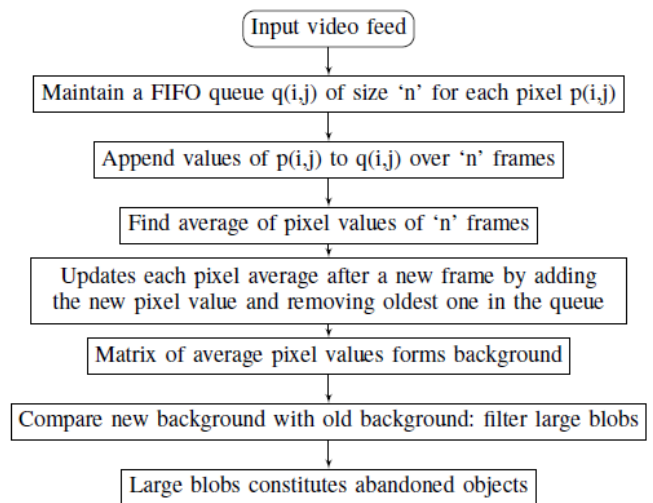

Figure 7: Proposed Flow chart.

Table 1

RST	EN	A	B	T	A-B	OUT
1	X	X	X	X	X	0
0	0	X	X	X	X	0
0	1	P	Q	R	$P-Q > R$	255
0	1	P	Q	R	$P-Q < R$	0

The RTL top view block diagram of Bg module is shown in the fig 8 below.

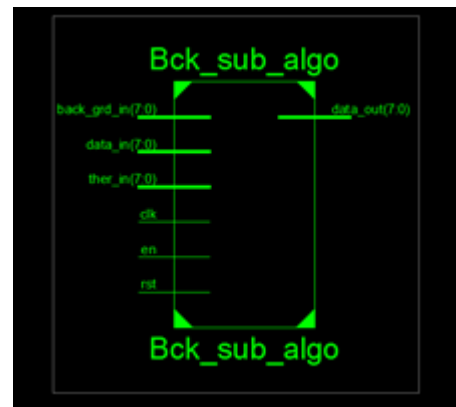

Figure 8: RTL Schematic block diagram of background subtraction

**Closing Filter:** the processed object which is obtained in the Bg module is in motion effect which has to be filtered to remove the unwanted noise (distorted pixels). The block diagram of closing filter is shown in the fig 9.

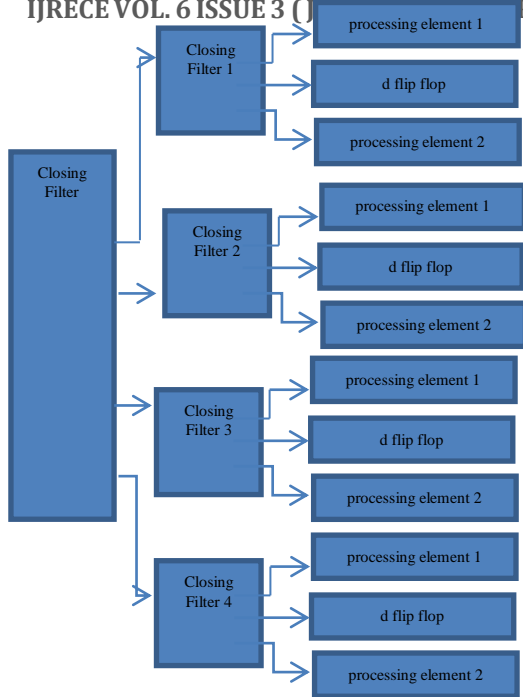

Figure 9: RTL Schematic block diagram of closing filter.

**Motion compensation:** after the motion compensation process module, we get the actual motion object's Image pixel values which is undistorted and smoothened. Table 2 shows the working process table of the Motion Compensation module.

Table 2

RST	A	B	CONDITION	OUT
1	X	X	X	0
0	P	Q	P=255	Q
0	P	Q	P!=255	0

Internal RTL schematic diagram of motion compensation module is shown in the fig 10.

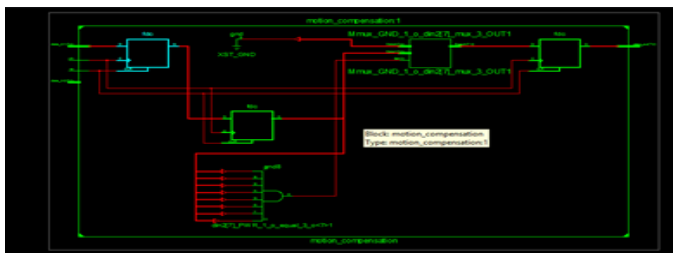

Figure 10: RTL Schematic internal block diagram of motion compensation module

### V. BACKGROUND UPDATATION

Feature extraction is used for registering new background. After the motion object is detected. Its feature is extracted by means of mean, standard deviation and skewness-kurtosis factors. In this paper we have implemented small artificial neural network (ANN) for training and checking fitness for the design and finally background is updated which will helps to reduce the false triggering. The below block diagram fig 11 shows the different layers of ANN module.

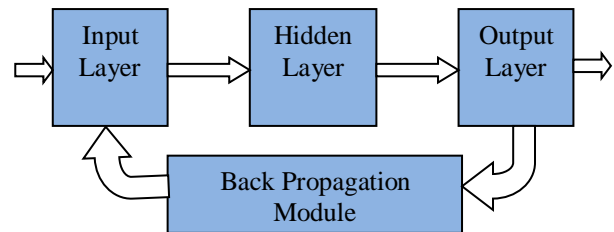

Figure 11. ANN internal architecture

The rtl schematic of the sub module of the hidden layer is shown in the fig 12.

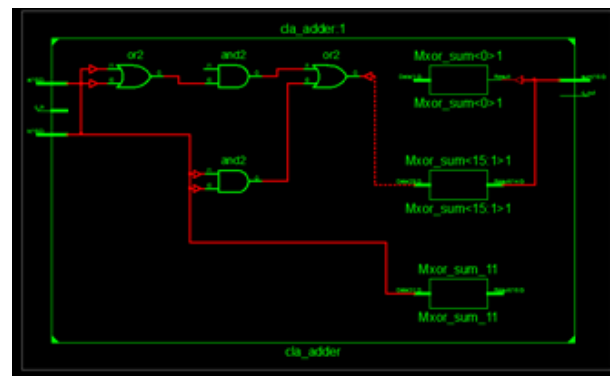

Figure 12: RTL Schematic internal block diagram of hidden layer.

### VI. RESULTS AND COMPARISONS

The proposed design synthesis results show that there is only 4% of device utilization. Table 3 gives the total device utilization for 3 x 3 generated block shows the consumption of just 1% of the total device.

Table 3. Design summary for Block Memory Generation

Device Utilization Summary (estimated values)				
Logic Utilization	Used	Available	Utilization	
Number of Slice Registers	2353	126800		1%
Number of Slice LUTs	4800	63400		7%
Number of fully used LUT-FF pairs	1080	6073		17%
Number of bonded IOBs	19	210		9%
Number of BUFG/BUFGCTRLs	1	32		3%

RGB to YCbCr conversion module simulation results are observed and verified as shown in below figure 13.

Table 4 gives the total device utilization for ANN top module block shows the consumption of just 3% of the total device.

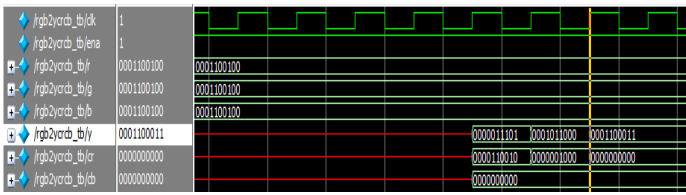

Figure 13: Simulation results for Conversion

Table 4. Design summary for ANN top module

Device Utilization Summary (estimated values)			
Logic Utilization	Used	Available	Utilization
Number of Slice Registers	4364	126800	3%
Number of Slice LUTs	9326	63400	14%
Number of fully used LUT-FF pairs	1257	12433	10%
Number of bonded IOBs	19	210	9%
Number of BUFG/BUFGCTRLs	2	32	6%

Background subtraction simulation results are observed and verified with the basic input data's as shown in figure 14.

RTL schematic of ANN module is shown in the fig15 below.

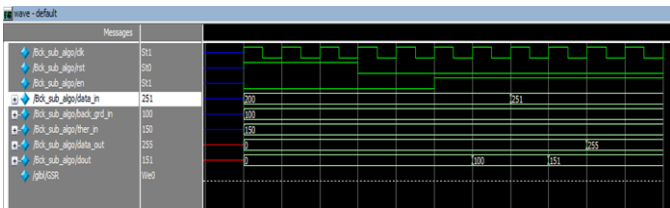

Figure 14: simulation results of background subtraction

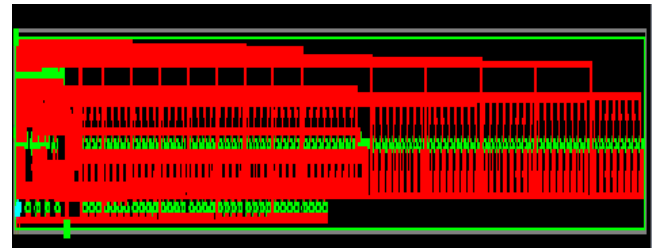

Figure 15: Simulation results for ANN

Closing filter simulation results are observed and verified with the basic input data's as shown in figure 15.

VII. CONCLUSION AND FUTURE WORK

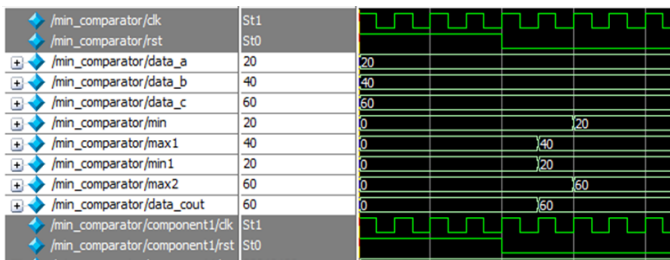
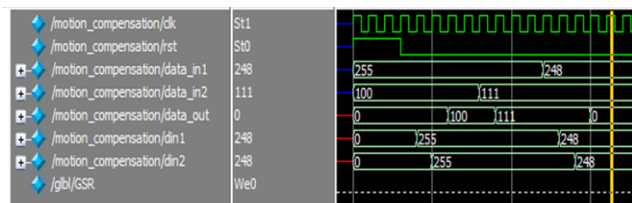

Figure 15: simulation results of closing filter

We have developed an efficient GMM algorithm to be implemented on FPGA that is capable of performing an operation of moving object detection for the standard video in dynamic environment conditions. The design works perfectly for the various lightening conditions in full day time. Hence it is capable for the outdoor usage or for monitoring in public places which is one of the major concern these days. In this paper we have discussed all the internal modules that were used in the development of the algorithm for the implementation and can conclude that the design is effective in terms of area on FPGA which is only 15% of the device utilization for Atrix 7 Xilinx FPGA. And also the timing has been improved for the in comparision to the previously implemented GMM algorithm. All the simulation results mentioned in the paper are verified for the behavioral functionality and meeting all the aspects of the requirements. The synthesis results obtained in the paper are based on the Xilinx Design suit. The design is perfectly suitable for the hardware real time implementation which is our next goal. Aslo we are working on the images obtain from various sources to see the compatibility with night camera and conditions.

Motion compensation simulation results are observed and verified with the basic input data's as shown in figure 16.

Figure 16: simulation results of motion compensation



## REFERENCES

- [1] I. Haritaoglu, D. Harwood, and L. S. Davis, "A fast background scene modeling and maintenance for outdoor surveillance," in *Proc. 15th Int. Conf. Pattern Recognit.*, vol. 4, Jan. 2000, pp. 179–183.
- [2] P. KaewTrakulPong and R. Bowden, "A real time adaptive visual surveillance system for tracking low-resolution colour targets in dynamically changing scenes," *Image Vis. Comput.*, vol. 21, no. 9, pp. 913–929, Sep. 2003.
- [3] B. Gloyer, H. K. Aghajan, K. Y. Siu, and T. Kailath, "Video-based freeway monitoring system using recursive vehicle tracking," *Proc. SPIE*, vol. 2421, pp. 173–180, Mar. 1995.
- [4] H. Jieménez and J. Salas, "Temporal templates for detecting the trajectories of moving vehicles," in *Advanced Concepts for Intelligent Vision Systems (Lecture Notes in Computer Science)*, vol. 5807. New York, USA: Springer-Verlag, Oct. 2009, pp. 485–493.
- [5] Z. Chaohui, D. Xiaohui, X. Shuoyu, S. Zheng, and L. Min, "An improved moving object detection algorithm based on frame difference and edge detection," in *Proc. 4th Int. Conf. Image Graph.*, Aug. 2007, pp. 519–523.
- [6] R. Mingwu and S. Han "A practical method for moving target detection under complex background," *Comput. Eng.*, vol. 31, no 20, pp. 33–34, Oct. 2005.
- [7] X. Benxian, L. Cheng, C. Hao, Y. Yanfeng, and C. Rongbao, "Moving object detection and recognition based on the frame difference algorithm and moment invariant features," in *Proc. 27th Control Conf.*, Jul. 2008, pp. 578–581.
- [8] S. Y. Chien, S. Y. Ma, and L. G. Chen, "Efficient moving object segmentation algorithm using background registration technique," *IEEE Trans. Circuits Syst. Video Technol.*, vol. 12, no. 7, pp. 577–586, Jul. 2002.
- [9] C. Ridder, O. Munkelt, and H. Kirchner, "Adaptive background estimation and foreground detection using Kalman filtering," in *Proc. Int. Conf. Recent Adv. Mech.*, 1995, pp. 193–199.
- [10] K. P. Karmann and A. Brandt, "Moving object recognition using an adaptive background memory," in *Time-Varying Image Processing and Moving Object Recognition*, V. Capellini, Ed. Amsterdam, The Netherlands: Elsevier, 1990, pp. 289–307.
- [11] J. Toyama, J. Krumm, B. Brumitt, and B. Meyers, "Wallflower: Principles and practice of background maintenance," in *Proc. Int. Conf. Comput. Vis.*, vol. 1, Sep. 1999, pp. 255–261.
- [12] J. C. S. Jacques, C. R. Jung, and S. R. Musse, "Background subtraction and shadow detection in grayscale video sequences," in *Proc. 18th Symp. Comput. Graph. Image Process.*, Oct. 2005, pp. 189–196.
- [13] C.-C. Chiu, M.-Y. Ku, and L.-W. Liang, "Robust object segmentation system using a probability-based background extraction algorithm," *IEEE Trans. Circuits Syst. Video Technol.*, vol. 20, no. 4, pp. 518–528, Apr. 2010.
- [14] T. Horprasert, D. Harwood, and L. S. Davis, "A statistical approach for real-time robust background subtraction and shadow detection," in *Proc. IEEE Frame-Rate Appl. Workshop*, Sep. 1999, pp. 1–19.