

INSTALLATION / OPERATION / MAINTENANCE

Applies to:

**Model VPT 120V 60Hz
Gas-Fired, Tubular, Radiant,
Low-Intensity Infrared Heater**



**Model VPT
High/Low Burner/Control Box
with 20 - 70 ft Tube/Reflector Length**

FOR YOUR SAFETY

If you smell gas:

1. Open windows.
2. Don't touch electrical switches.
3. Extinguish any open flame.
4. Immediately call your gas supplier.

FOR YOUR SAFETY

The use and storage of gasoline or other flammable vapors and liquids in open containers in the vicinity of this appliance is hazardous.

WARNING: Improper installation, adjustment, alteration, service, or maintenance can cause property damage, injury or death. Read the installation, operation, and maintenance instructions thoroughly before installing or servicing this equipment.

WARNING: Gas-fired appliances are not designed for use in hazardous atmospheres containing flammable vapors or combustible dust, in atmospheres containing chlorinated or halogenated hydrocarbons, or in applications with airborne silicone substances.


Introduction.

Welcome to the new range of powered HiLo infra-red heaters. Local regulations may vary and it is the installer's responsibility to ensure that such regulations are satisfied.

All installation, assembly, commissioning and service procedures must be carried out by suitable qualified competent persons and conform with local building codes, or in the absence of local codes, with the National Fuel Gas Code ANSI Z223.1/NFPA 54 or the National Gas and Propane Installation Code CSA B149.1.

When assembling, installing, commissioning

and servicing is undertaken on radiant tube heaters specified in these instructions, due care and attention is required to ensure that working at height regulations are adhered to

 **PLEASE READ** this document prior to installation to familiarize yourself with the components and tools you require at the various stages of assembly.

All Dimensions shown are in inches unless otherwise stated.

The manufacturer reserves the right to alter specifications without prior notice.

Document Index.

1 Installation Requirements

- 1.1 Health & Safety
- 1.2 Heater Suspension
- 1.3 Clearance to Combustibles
- 1.4 Gas Connection & Supply Details
- 1.5 Electrical Connections
- 1.6 Ventilation Requirements
 - 1.6.1 Unvented Units
 - 1.6.2 Vertical Venting
 - 1.6.3 Horizontal Venting
- 1.7 Fresh Air Intake
- 1.8 Technical Details

2 Assembly Instructions

- 2.1 Tools Required
- 2.2 Assembly Notes
 - 2.2.1 Emitter tubes
 - 2.2.2 Turbulator Strips and Burner Inserts
 - 2.2.3 Brackets
 - 2.2.4 Couplers
 - 2.2.5 Reflectors
 - 2.2.6 End Caps (optional)
 - 2.2.7 Bends (where required)
 - 2.2.8 Burner/Fan Assembly
 - 2.2.9 Detailed Assembly Drawings

3 Start Up Instructions

- 3.1 Tools Required
- 3.2 Start up procedure

4 Servicing Instructions

- 4.1 Tools Required
- 4.2 Burner Description
- 4.3 Burner Removal
- 4.4 Burner Gas Injector Servicing
- 4.5 Burner Head and Electrode Servicing
- 4.6 Combustion Fan Assembly
- 4.7 Emitter Tube Servicing
- 4.8 Reflector Servicing
- 4.9 Cleaning of Vent
- 4.10 Re-commissioning after Service

5 Troubleshooting Guide

6 Replacing Parts

- 6.1 Burner Controller Replacement
- 6.2 Air Pressure Switch Replacement
- 6.3 Gas Valve Replacement

7 User and Operating Instructions

- 7.1 To Start Heater
- 7.2 To Switch Off Heater
- 7.3 Servicing

1. Installation Requirements.

1.1 Health and Safety

- A. Heater is intended for heating non-residential indoor spaces and should only be installed where flammable gases or vapors are not present.
- B. Heaters can be suspended horizontally or at any angle along the axis of the tubes but can only be rotated about the burner head 0 to 55°. See section 1.3 for clearance dimensions.

C. The installation must conform with local building codes or, in the absence of local codes, with the *National Fuel Gas Code, ANSI Z223.1/NFPA 54* or the *Natural Gas and Propane Installation Code, CSA B149.1*.

D. The unit shall be electrically grounded in accordance with National Electric Code ANSI/NFPA 70 and Canadian Electrical Code CSA C22.1.

E. The heater may be installed in aircraft hangars in accordance with the Standard for *Aircraft Hangars, ANSI/NFPA 409* and in

automotive garages when installed in accordance with the Standard for *Parking Structures, ANSI/NFPA 88A*, or the Standard for *Repair Garages, ANSI/NFPA 88B*, or the *Canadian Natural Gas and Propane Installation Code, CSA B149.1*, and are so marked.

Ensure that minimum clearances will be maintained to vehicles parked below the heater.

F. The standard heaters are approved for installations between 0 - 2000ft (0 - 610m) above sea level for the US and 0 - 4500 ft (1370m) above sea level for Canada. Conversion kits are available for installations above these heights in the USA.

G. **Massachusetts Requirement:** If the heater is being installed in the Commonwealth of Massachusetts, this unit must be installed by a licensed plumber or licenced gas fitter.

1.2 Heater Suspension


Attachment to the heater support lugs should be made by D shackle. The hanging attachments to overhead steelwork etc. have

to be designed and produced in accordance with sound engineering practices. They must be adequately fixed and designed to carry the whole weight of the heater. In the event of suitable roof steelwork being unavailable, additional steelwork should be fitted to enable vertical hangers to be used for suspending the heaters.

These methods are illustrated in Figure 1. If there are any doubts as to the strength or suitability of roof steelwork to which heaters are to be suspended, please refer to a Consultant, Architect or owner of the building.

It is recommended that the heater is raised to its final position once the assembly of the emitter tube/bracket/reflector has been completed. Longer tube assemblies may be raised in more than one sub-assembly with final emitter tube connection made in the air.

Ensure that the installer uses the burner roof support mounting bracket when suspending the heater. This is situated on the front of the burner. When packed the bracket is reversed and must be turned to its correct state for mounting. (ref page 15)



WARNING:

If not installed, operated and maintained in accordance with the manufacturer's instructions, this product could expose you to substances in fuel or from fuel combustion which are known to the state of California to cause cancer, birth defects or other reproductive harm.

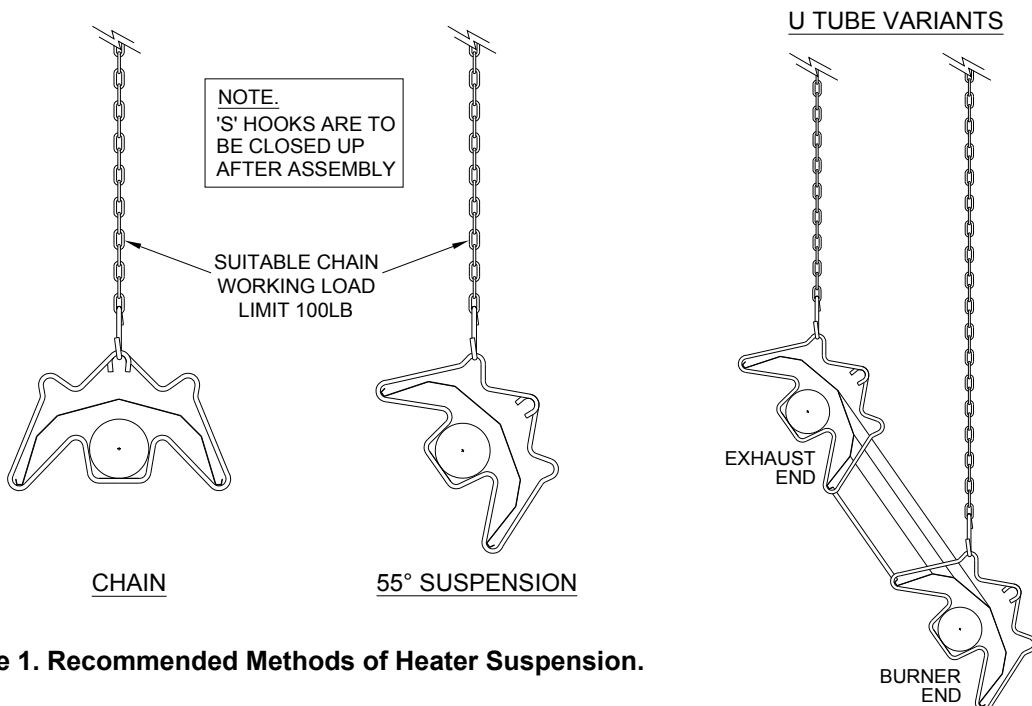
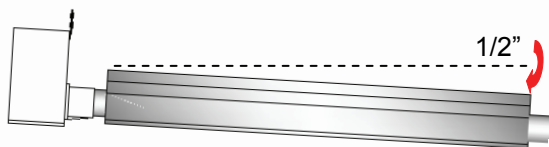


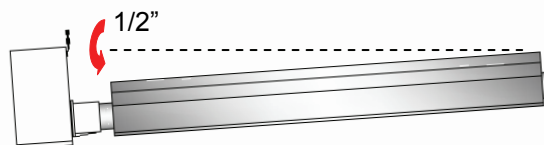
Figure 1. Recommended Methods of Heater Suspension.



ON VENTED HEATERS, THE HEATER SHOULD SLOPE DOWNWARDS AWAY FROM THE BURNER AND ON UNVENTED HEATERS SHOULD SLOPE DOWNWARDS TOWARDS BURNER BY APPROX. 1/2" FOR HORIZONTAL INSTALLATIONS AS SHOWN BELOW (DIAGRAMS EXAGGERATED FOR CLARITY)



VENTED



UNVENTED

1.3 Clearance to Combustibles.

Minimum clearance to combustibles are shown in Table 1 below.

IMPORTANT:

The stated clearance to combustibles represents a surface temperature of 90°F (50°C) above room temperature. Building material with a low heat tolerance (such as plastics, vinyl siding, canvas, tri-ply, etc.) may be subject to degradation at lower temperatures. It is the installer's responsibility to assure that adjacent materials are protected from degradation.

Table 1	Clearance to Combustibles, inches (cm)									
MODEL	A	A1 / A2	B	B1	C1	C2	C3	D1	D2	E
60	74 (188)	15° = 72 (183) 25° = 68 (173) 35° = 61 (155) 45° = 53 (135) 55° = 43 (110)	29 (74)	41 (105)	20 (51) / 10* (26)*	8 (21)	22 (56)	8 (21)	12 (31)	12 (31)
80	74 (188)		29 (74)	41 (105)	20 (51) / 10* (26)*	8 (21)	22 (56)	8 (21)	12 (31)	12 (31)
100	74 (188)		32 (82)	41 (105)	20 (51) / 10* (26)*	8 (21)	22 (56)	8 (21)	16 (41)	12 (31)
125	74 (188)		39 (99)	47 (120)	20 (51) / 10* (26)*	8 (21)	22 (56)	20 (51)	18 (46)	12 (31)
150	74 (188)		39 (99)	48 (122)	20 (51) / 10* (26)*	8 (21)	22 (56)	20 (51)	18 (46)	12 (31)
170	86 (219)	15° = 82 (209) 25° = 78 (199) 35° = 71 (181)	48 (122)	48 (122)	20 (51) / 10* (26)*	11 (28)	22 (56)	20 (51)	20 (51)	12 (31)
200	86 (219)	45° = 61 (155) 55° = 50 (127)	48 (122)	48 (122)	20 (51) / 10* (26)*	11 (28)	22 (56)	20 (51)	20 (51)	12 (31)

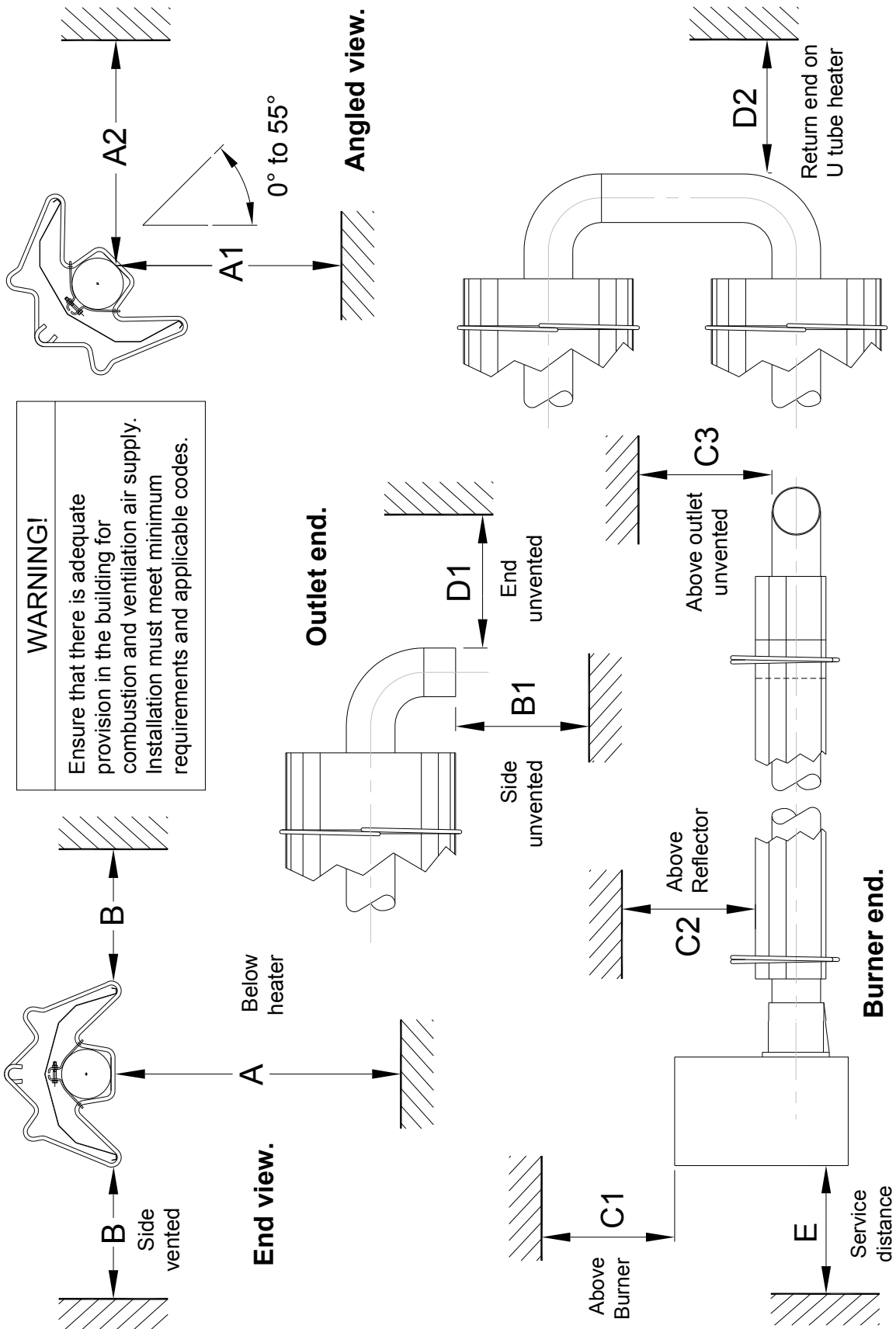
* distance with end caps fitted.



WARNING: Minimum clearance from the heater must be maintained from vehicles parked below heater. In all situations, clearances to combustibles must be maintained. Signs should be posted in storage areas to specify maximum stacking height to maintain required clearance to combustibles. Such signs must either be posted adjacent to the heater thermostats or in the absence of such thermostats in a conspicuous location. Refer to mounting clearance tables.

Figure 2 Clearance to Combustibles (Standard indoor reflectors)..

! The minimum clearances to combustible materials are given in Table 1. These minimum distances **MUST** be adhered to at all times. Adequate clearance **MUST** be provided around air openings into the combustion chamber and there **MUST** be suitable clearance for accessibility and for combustion / ventilating air supplies.



1.4 Gas Connection and Supply

WARNING: Before installation, check that the local distribution conditions, nature of gas and pressure, and adjustment of the appliance are compatible.

The gas connection on the heater is 1/2" N.P.T internal thread.

Injector sizes and manifold pressure for the burners are shown in the table 3. The gas supply piping and connections must be installed so that the minimum pressure stated is achieved.

A gas shut off valve and union should be fitted in the gas supply line close to the heater and a 1/8" N.P.T plugged tapping, accessible for test gauge connection, provided immediately upstream of the appliance gas inlet.

It is essential to provide some flexibility in the final gas connection by use of an approved flexible gas connector. (See Fig 4.)

i Take care when making a gas connection to the heater not to apply excessive turning force to the internal controls.

Care must be taken to observe the pipe bend diameter of 12" (30cm) and pipe displacement distance of 3" (7.62cm).

i The correct installation as shown will allow for approx 4" of movement due to expansion.

* Connector must be certified for use on a radiant tube type infrared heater and must comply with Standard for Connectors for Gas Appliances, ANSI Z21.24/CSA 6.10 or with the Standard for Elastomeric Composite Hose and Hose Couplings for Conducting Propane and Natural Gas, CAN/CGA 8.1.

For heaters up to 150,000Btu/h, 1/2" ID x 24" long
 For heaters 150,000Btu/h and above, 3/4" ID x 36" long
 NOTE: For Canada all heaters MUST use a hose 36" long
 (See Table 3)

Figure 3. Correct orientation of Ball Valve

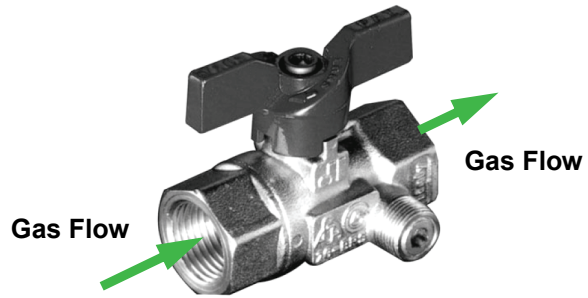
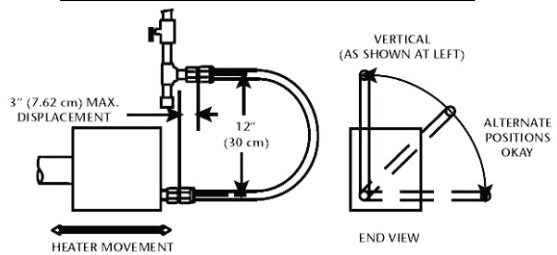


Figure 4. Correct Installation of Flexible Gas Connection

CORRECT POSITIONS



INCORRECT POSITIONS

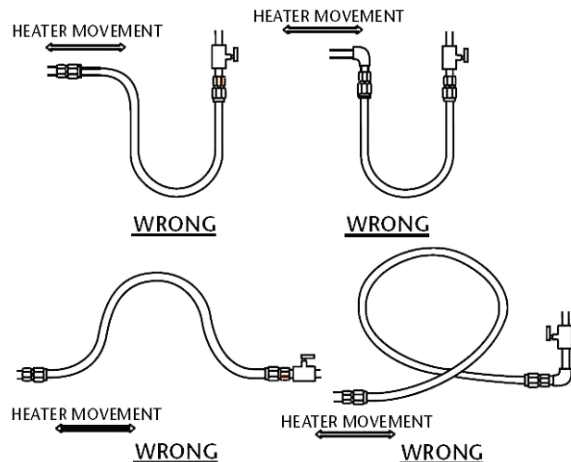


Table 3

HOSE SIZE	USA	CANADA
3/4"	CE4	CONTACT FACTORY

WARNING: FIRE OR EXPLOSION HAZARD - It is essential to provide some flexibility in the final gas line connection by use of an approved flexible connector as shown in the drawings. Expansion of the radiant pipe occurs with each firing cycle causing the burner to move with respect to the gas line. This can result in a gas leak producing an unsafe condition.



CONNECTOR MUST BE INSTALLED IN A "U" CONFIGURATION. FOR HEATERS UP TO 150,000 BTU/H, A 24" LONG CONNECTOR OF AT LEAST 1/2" ID MUST BE USED. FOR HEATERS ABOVE 150,000 BTU/H, A 36" LONG CONNECTOR OF AT LEAST 3/4" NOMINAL ID MUST BE USED.

Table 4 Gas Supply Pressures

Gas Type	Natural Gas	LP/Propane Gas
Min Required Gas Pressure (in W.C)	7.0	11.0
Max Supply Pressure (in W.C)	14.0	14.0
Gas Supply	Connection 1/2" N.P.T thread	

1.5 Electrical Connections

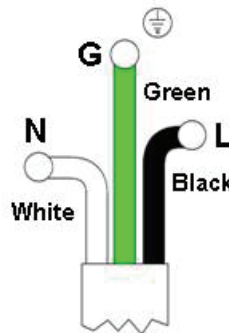


WARNING: Before making electrical connections, switch OFF the main electrical disconnect. There may be more than one disconnect switch. Lock out and tag switch with a suitable warning label. Electrical shock can cause personal injury or death.

Important: All electrical work should be done by a qualified electrician in strict accordance with the National Electrical Code ANSI/NFPA 70 or Canadian Codes CSA C22.1.

This appliance must be electrically grounded

Supply 120V 60Hz single phase.
 Standard heater 0.16HP.
 Current rating (inductive):
 1.8 amp max (models 60 - 150)
 1.0 amp max (models 170 & 200)
 Fuse: external 3 amp.

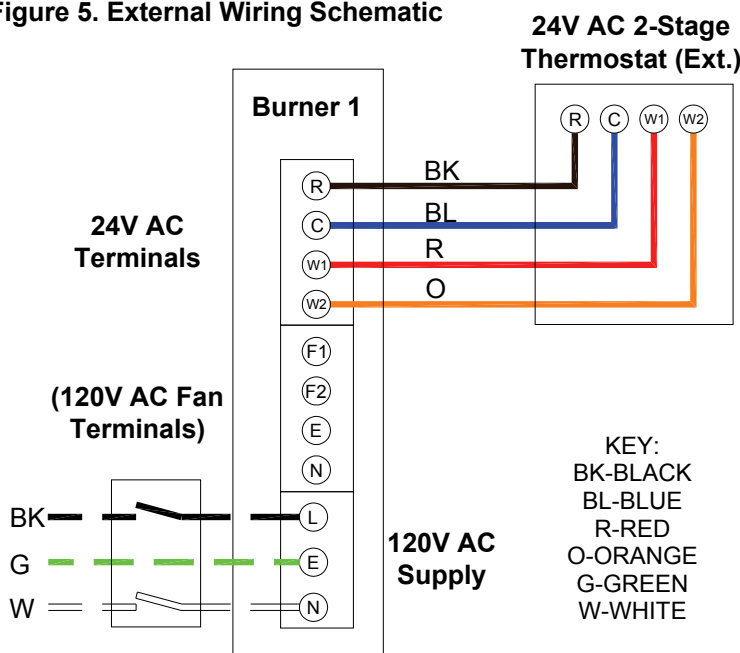


The electrical supply to the heater is by three wires: hot (Live), neutral and ground connections.

Install in accordance with all state & local codes.

Where alternative manufacturers controls are used, please refer to their installation details.

Figure 5. External Wiring Schematic



Notes:

Use 18/4 class 2 thermostat cable between heater and thermostat.

Max. length @ 18 Awg (0.8mm²) = 100ft.

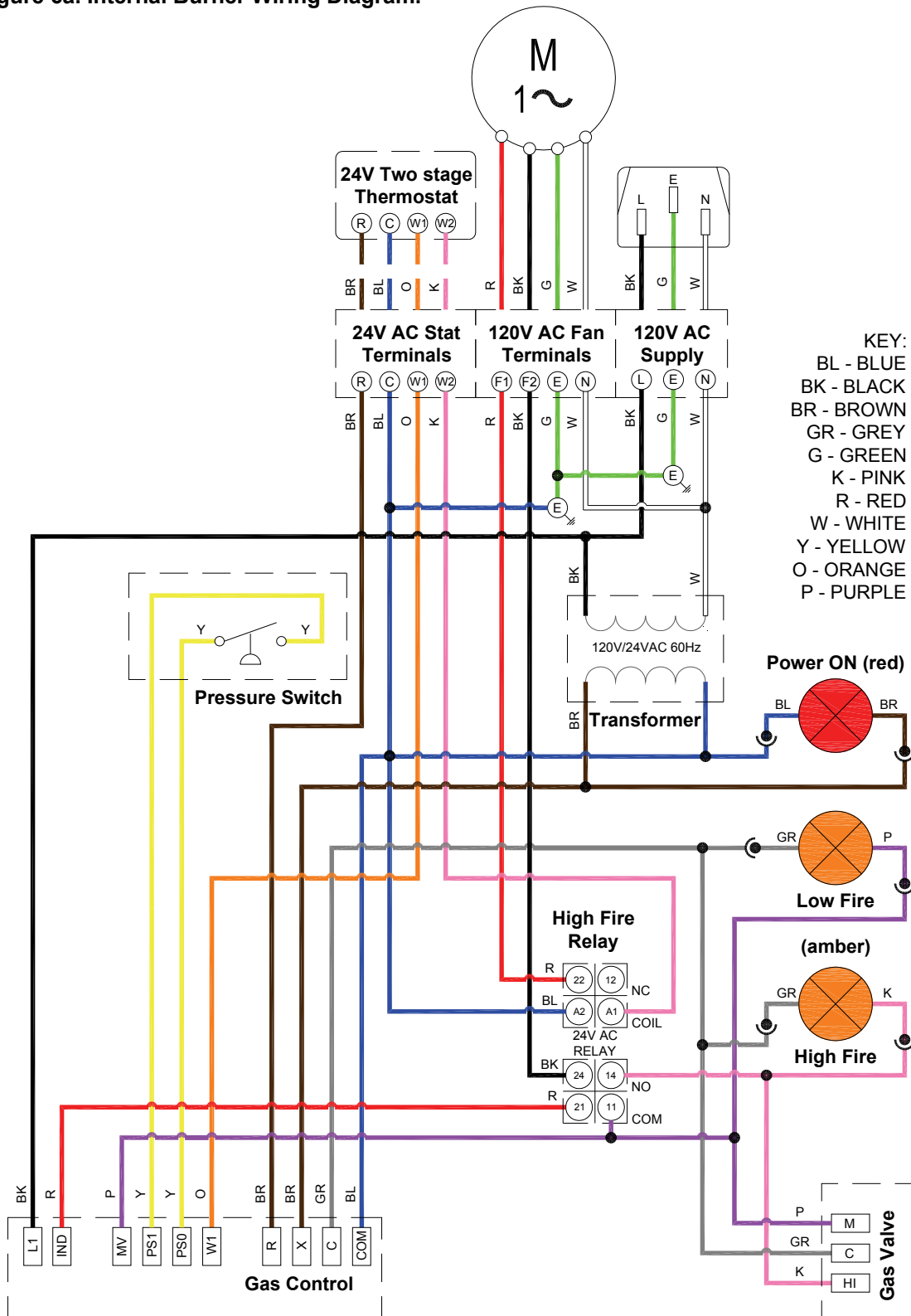
Only one burner can operate from one thermostat as supplied.

When servicing heaters ensure the electricity supply is isolated from the mains supply.

120V AC supply is still present at each burner when the thermostat is switched off.

KEY:
 BK-BLACK
 BL-BLUE
 R-RED
 O-ORANGE
 G-GREEN
 W-WHITE

Figure 6a. Internal Burner Wiring Diagram.



NOTES:-

Power On light is permanently illuminated when 120V / 60 Hz AC external supply is connected to burner.

Additional wiring is required to install an optional extra thermostat and / or time clock.

Wire specification:- 18 AWG (1.0mm²), Tri-rated, 105°C

⚠ If any of the original wire as supplied with the appliance must be replaced, it must be replaced with wiring material having a temperature rating of at least 220°F/105°C

1.5.1 Multiple burner configurations (Master & Slave) via Optional Relay . Refer to figure 6b and 6d.

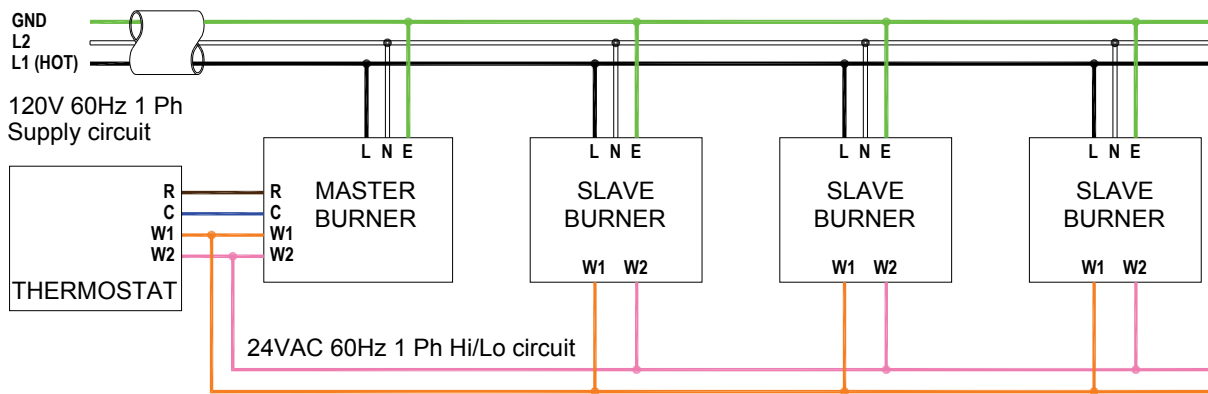
Multiple VPT burners can be controlled via one main burner. In this scenario the main burner is known as the 'Master' and any additional burners are known as 'Slaves'.

The external two stage thermostat is connected to the Master burner and powered via the inbuilt transformer. The total burner load for the Master is 20VA. Each additional 'Slave' burner is 1.6VA

The Thermostat chosen to control the multiple heaters must not have a power requirement exceeding the spare capacity as shown in the examples below:

CONFIGURATION	TOTAL BURNER LOAD	SPARE FOR THERMOSTAT
Master PLUS 1 Slave	21.6VA	18.4VA
Master PLUS 3 Slaves	24.8VA	15.2VA
Master PLUS 5 Slaves	28.0VA	12.0VA
Master PLUS 7 Slaves	31.3VA	8.8VA

Figure 6b. Wiring schematic. Multiple Burners Master and Slave.



1.5.2 Multiple burner configuration via independently powered two stage thermostats. Refer to figures 6c and 6d.

Note: If the thermostat has an independent power supply, all burners in the zone to be controlled **MUST** be Slave burners.

The maximum number of Slave burners per thermostat is dependent on the maximum power output of the thermostat selected.

Each 'Slave' burner is rated at 1.6VA 24VAC 60Hz.

The external two stage thermostat is powered via its own power supply and must output to each Slave burner - 24VAC for low fire to terminal W1 and 24VAC for hi fire to both terminals W1 and W2

Refer to thermostat manufactures literature for details.

Figure 6c. Wiring schematic. Multiple Burners via independently powered Relay.

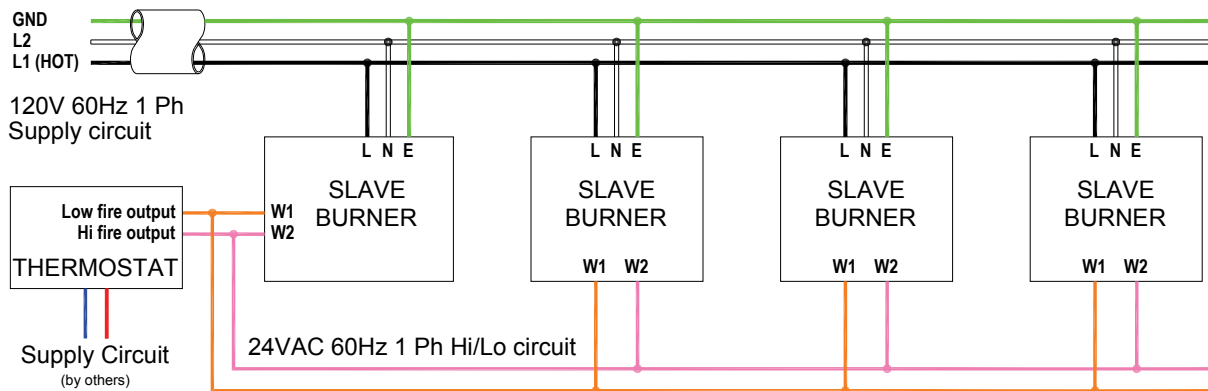
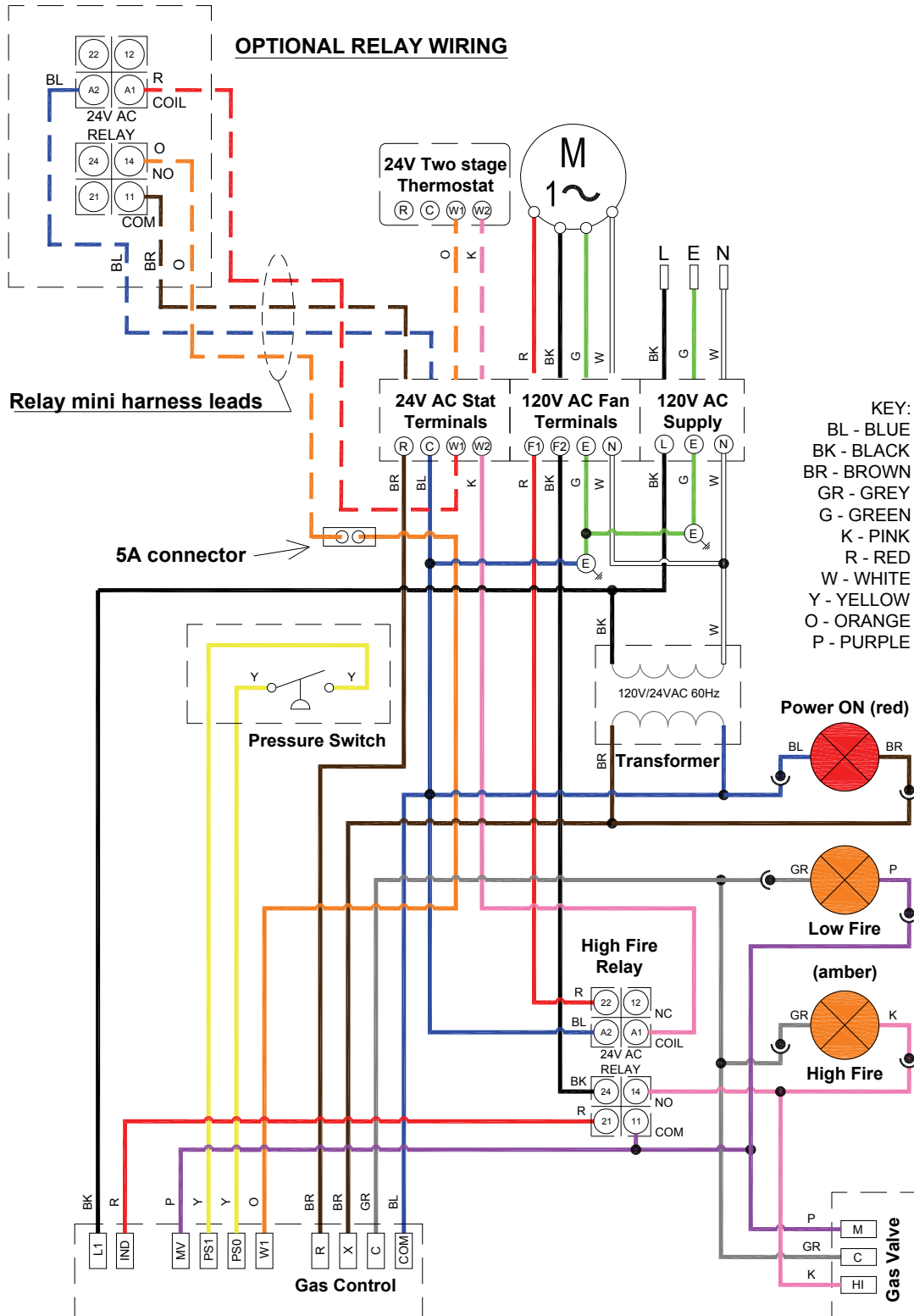



Figure 6d. Internal Slave Burner Wiring/External Schematic Diagram with Optional Relay.



NOTES:-

Power On light is permanently illuminated when 120V / 60 Hz AC external supply is connected to burner.
 Additional wiring is required to install an optional extra thermostat and / or time clock.
 Wire specification:- 18 AWG (1.0mm²), Tri-rated, 105°C

 If any of the original wire as supplied with the appliance must be replaced, it must be replaced with wiring material having a temperature rating of at least 220°F/105°C

1.6 Vent Requirements and Details

1.6.1 Unvented units

Heaters may be installed unvented providing the governing building codes are met and consideration is properly given to possibilities of condensation on cold surfaces.

Installation shall meet the following requirements when unvented:

- Natural or mechanical means shall be provided to supply and exhaust at least 4 CFM per 1000 BTU per hour input of installed heaters.
- Combustion gases shall not impinge on combustible materials.

1.6.2 Vertical venting

The heater can be installed with a vertical vent.

All vent piping should be adequately supported from the building structure and terminated with an approved terminal. **The maximum recommended vent length is 25ft (7.6m) with a maximum of two elbows.** All connections should be properly sealed. refer fig 7a

1.6.3 Horizontal venting

Individual units can be vented horizontally through side walls. Recommended terminals are Part Numbers 111848 for 4" and 111850 for 6".

Distances from adjacent public walkways, adjacent buildings, openable windows and building openings, consistent with the *National Fuel Gas Code, ANSI Z223.1/NFPA 54* or the *Natural Gas and Propane Installation Code, CSA B149.1*.

The maximum recommended vent length is 25ft (7.6m) with a maximum of two 90° elbows. However runs up to 12ft (3.6m) can use 4" (101mm) vent pipe. Runs over 12ft (3.6m) should always use 6" (152mm) vent pipe.

An approved clearance thimble is required when the flue pipe passes through combustible materials. Follow the requirements of the thimble manufacturer.

Standard vent terminals must extend at least 6" (152mm) from the wall and at least

24" (609mm) from any combustible overhang. This protects the building material from degradation by the vent gases.

Vent joints should be sealed and secured according to the vent manufacturers instructions. Should condensation occur the vent should be shortened or insulated.

The terminal should be at least 3ft (0.91m) from any air intake to the building.

The vent terminal must be installed at a suitable height above the ground to prevent blockage by snow.

1.7 Fresh Air Intake

Whenever the heater is installed in locations where airborne dust or other pollutants are present, a fresh air supply should be ducted to the burner.

If the heater is equipped with ducted combustion air, the vent terminal must be at least 3ft (0.91m) away from the air inlet and located higher than the inlet.

A fresh air duct of 4" (101mm) diameter should be installed from the fresh air to the air intake connection on the fan housing. A flexible jointing piece should be installed at the fan connection with hose clamps to facilitate expansion and contraction.

The maximum recommended length air duct is 25ft (7.6m) and the maximum number of elbows is two. The minimum length is 18" (456mm).

The location of the fresh air duct inlet must be where it will receive dust free clean air. An inlet cap with bird screen must be fitted at the inlet of the duct. If the duct inlet is located above the roof the underside of the inlet terminal must be at least 2ft (0.61m) above roof level (or above projected snow load) and at least 10" (254mm) above any projection on the roof within 7ft (2.1m) of the inlet. Intake pipe, fittings and sealant are not furnished by the manufacturer. Refer fig 7c & d.

Note the vent terminal must NOT be installed below the fresh air intake, and should have a minimum separation distance of 36" from the air intake.

Note The vent terminal should be installed so as to be in the same atmospheric pressure zone as the combustion air inlet of the appliance.

Figure 7.a Vertical Venting.

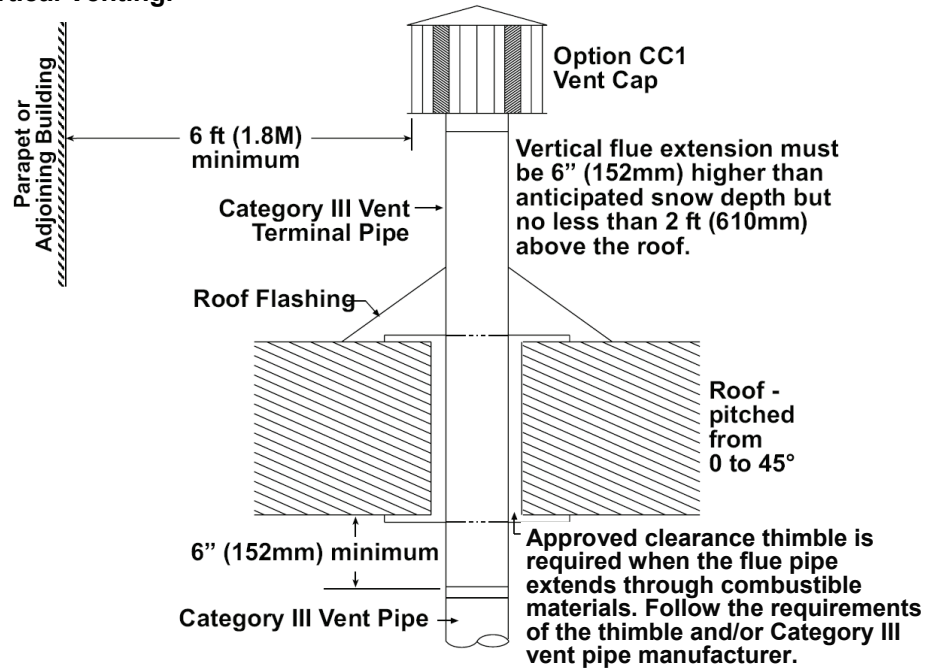
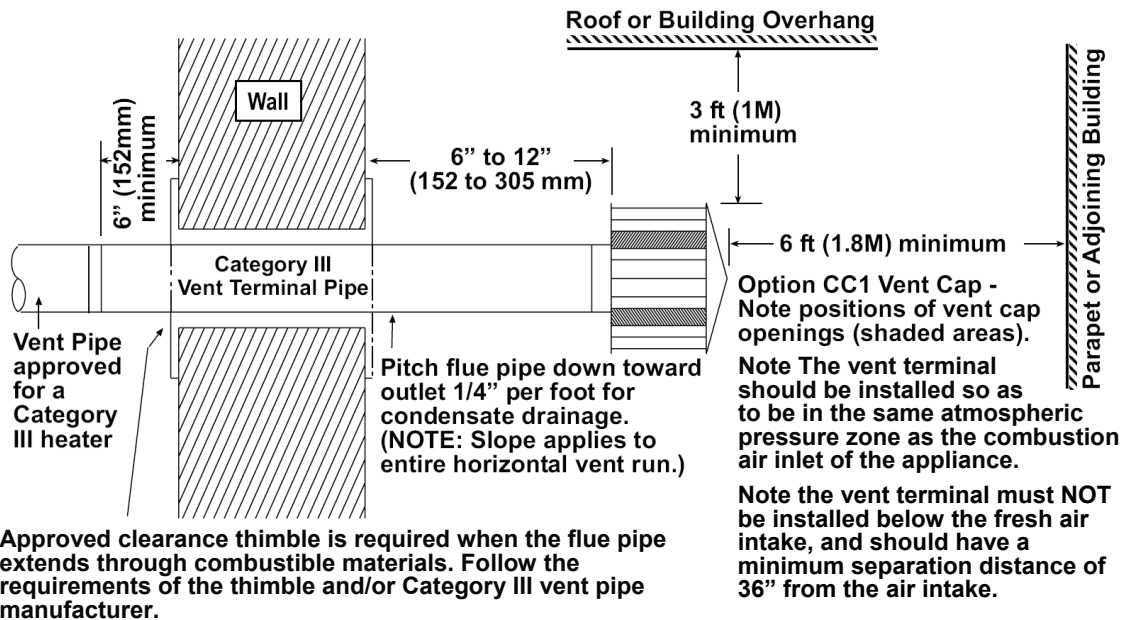
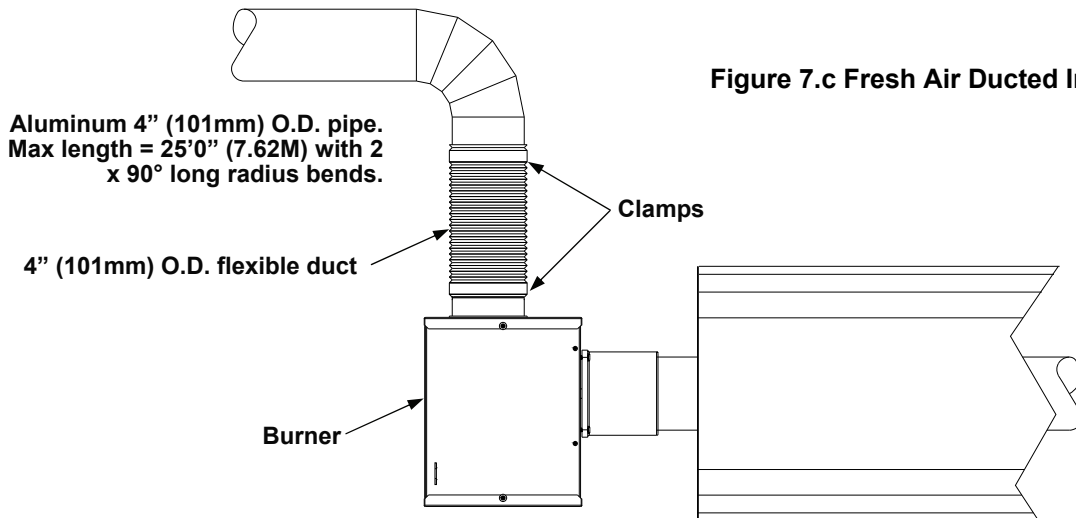


Figure 7.b Horizontal Venting (plan view shown).



Approved clearance thimble is required when the flue pipe extends through combustible materials. Follow the requirements of the thimble and/or Category III vent pipe manufacturer.

Figure 7.c Fresh Air Ducted Intake.



1.8 Technical Details - Table 5

No of Injectors	1
Gas Connection	½" N.P.T
Electrical Supply	120 volt 1 phase 60Hz
Vent size (in)	4" or 6" (101mm or 152mm)
Unitary Fan Motor Details	120 volt 1 phase 60Hz
Current Rating	1.8A MAX (models 60 - 150); 1.0A MAX (models 170 & 200)
Ignition	Electronic Program Start up with Spark Ignition

MODEL	Natural Gas	LP Gas	Min. Heater Length	Max. Heater Length	Min. Heater Length	Max. Heater Length
	High / Low	High / Low	S ft	S ft	U ft	U ft
60	60,000/48,000	60,000/48,000	20	40	20	40
80	80,000/60,000	80,000/60,000	30	40	40	40
100	100,000/75,000	100,000/75,000	30	40	40	40
125	123,500/95,000	125,000/95,000	30	50	40	40
150	150,000/100,000	150,000/100,000	40	60	40	60
170	169,000/125,000	169,000/125,000	50	70	60	60
200	200,000/160,000	N/A	50	70	60	60

Appliances can be installed up to 10,000ft above sea level in the USA. Altitude conversion kits are available on request.

USA	0- 2000 ft (0-610m) above sea level						
Size	60	80	100	125	150	170	200
Gas	Natural Gas						
Hi "WC	3.9	3.5	4.5	4.3	4.0	3.3	4.0
Lo "WC	2.6	2.3	3.0	2.7	2.1	1.9	2.5

CANADA	0- 2000 ft (0-610m) above sea level						
Size	60	80	100	125	150	170	200
Gas	Natural Gas						
Hi "WC	3.9	3.5	4.5	4.3	4.0	3.3	4.0
Lo "WC	2.6	2.3	3.0	2.7	2.1	1.9	2.5

USA	0- 2000 ft (0-610m) above sea level						
Size	60	80	100	125	150	170	200
Gas	LP Gas						
Hi "WC	5.5	5.2	8.0	7.6	7.0	6.1	N/A
Lo "WC	3.5	2.9	4.4	4.6	3.3	3.6	N/A

CANADA	0- 2000 ft (0-610m) above sea level						
Size	60	80	100	125	150	170	200
Gas	LP Gas						
Hi "WC	5.5	5.2	8.0	7.6	7.0	6.1	N/A
Lo "WC	3.5	2.9	4.4	4.6	3.3	3.6	N/A

Technical Details continued

USA & CANADA	Natural Gas 0- 2000 ft (0-610m)						
Size	60	80	100	125	150	170	200
Burner Orifice Plate Part No.	269941	269942	269943	269944	1005513	269946	269946
Flame Plate Part No.	N/A						
Fan Part No.	270464					270467	
Fan Orifice Part No.	269922	269925	269925	269930	269931	266935	269938
Injector Part No.	270400	270402	270403	270405	270407	270409	270410
Injector Carrier Part No.	270375					270376	
Pressure Switch Part No.	270389						270390


USA & CANADA	LP Gas 0- 2000 ft (0-610m)							
Size	60	80	100	125	150	170	200	
Burner Orifice Plate Part No.	269948	269949	269950	269951	269952	269953	N/A	
Flame Plate Part No.	269957	269958		269959		269960		
Fan Part No.	270464					270467		
Fan Orifice Part No.	269924	269925	269929	266931	269933	269937		
Injector Part No.	270398	270399		270400	270401	270403		
Injector Carrier Part No.	270375							
Pressure Switch Part No.	270389							

MODEL VCT	U Tube			Straight Tube					
	U20	U40	U60	S20	S30	S40	S50	S60	S70
60	•	•		•	•	•			
80		•			•	•			
100		•			•	•			
125		•			•	•	•		
150		•	•			•	•	•	
170			•				•	•	•
200*			•				•	•	•


* Nat Gas ONLY


MODEL VCT	Emitter Tube Type Material		Min. Distance to Bend ft (m)
	Calcoat™	Mild Steel	
60	TUBE 1	REMAINDER	10 (3.0)
80	TUBE 1	REMAINDER	10 (3.0)
100	TUBE 1	REMAINDER	15 (4.6)
125	TUBE 1	REMAINDER	15 (4.6)
150	TUBE 1	REMAINDER	20 (6.1)
170	TUBE 1 & 2	REMAINDER	25 (7.6)
200	TUBE 1 & 2	REMAINDER	25 (7.6)

2. Assembly Instructions.

 **PLEASE READ** this section prior to assembly to familiarize yourself with the components and tools you require at the various stages of assembly. Carefully open the packaging and check the contents against the parts and check list.

The manufacturer reserves the right to alter specifications without prior notice.

 Please ensure that all packaging is disposed of in a safe environmentally friendly way.

 For your own safety we recommend the use of safety boots and leather faced gloves when handling sharp or heavy items. The use of protective eye wear is also recommended.

2.1 Tools Required.

The following tools and equipment are advisable to complete the tasks laid out in this manual.



Saw Horses



Leather Faced Gloves



Phillips Screwdriver



Wrench Set



Cordless Drill



5/16" Drive



3/16" (5mm)
5/32" (4mm)
Allen wrench



Tape Measure

 Suitable alternative tools may be used.

2.2 Assembly Notes.



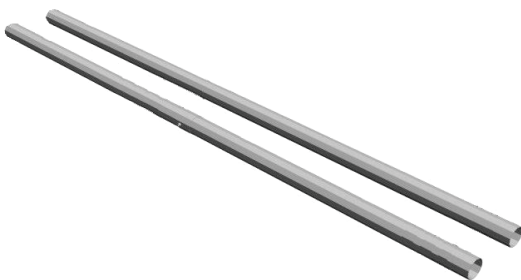
Please read these assembly notes in conjunction with the correct assembly drawings (figs 9 to 17).

2.2.1 Emitter Tubes

Each heating unit has two types of emitter tube. For details of the tube types and position please refer to the table (page 14 of this instruction manual).

Identify and position emitter tubes on saw horses. For aesthetics it is advisable to position **all tube seams facing down**. Position coupling fastener so that these cannot be seen from beneath the heater.

Mark out the position of the bracket centers from the dimensions shown on the assembly drawings.



2.2.2 Turbulator Strips and Burner Inserts

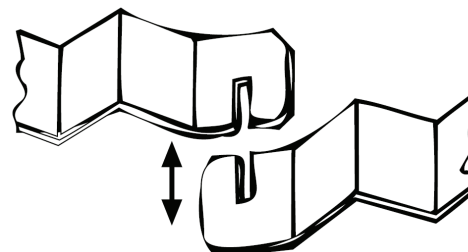
Ensure that the correct turbulator or burner insert is fitted, as this could void your warranty if they are incorrectly fitted or omitted when necessary.

2.2.2.1 Turbulator Strips

Turbulator strips should be inserted (when required) into the correct emitter tube exactly as indicated in the assembly drawings.

Locate turbulator strip sections. Install the first turbulator strip into the open end of the last emitter tube (only after it has been suspended and connected to the previous emitter tube.)

Interlock the next section of turbulator strip as shown in the diagram below.



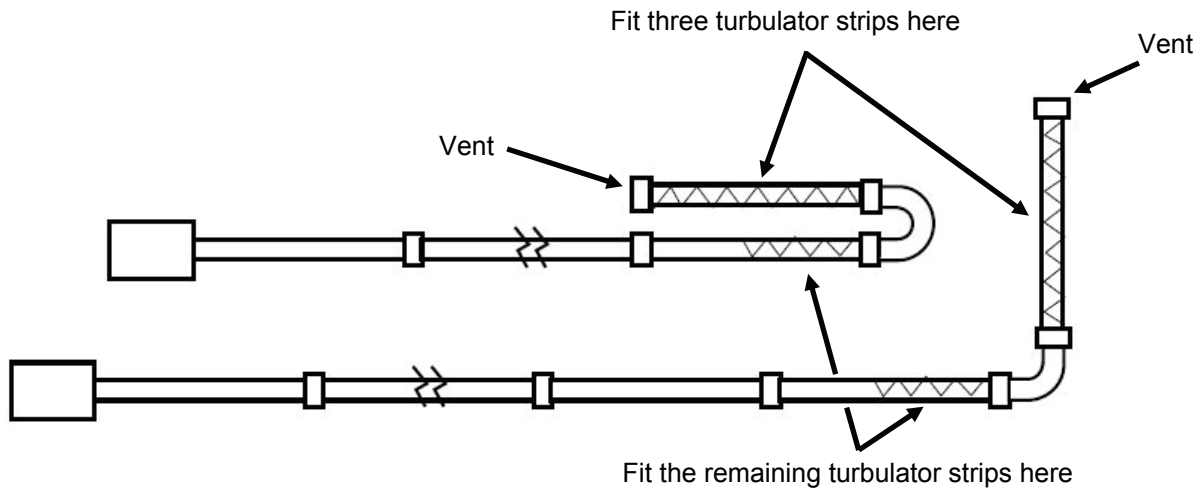


Slide the connected sections into the emitter tube(s). Add further strips to form the correct length required.

2.2.2.2

Where a heater configuration requires more than three turbulator strips and has the exhaust heat exchanger tube adjacent to an "L" or "U" heat exchanger tube, refer to the diagram below for positions.

For specific configurations see detailed assembly diagrams on pages 21 to 29.



Model 200 S50 fan orifice plate

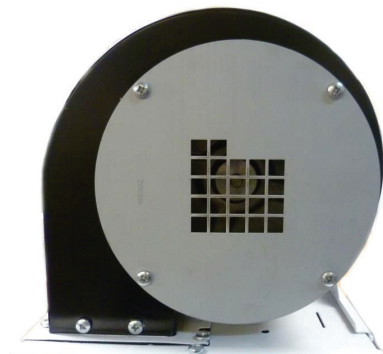
This model has a different fan orifice plate (Part No.269939) to all other models in the range. It is supplied with every burner as a loose item and should be discarded if not needed. This must be fitted to the 200 S50 model only.

Note: There should be 22 10mm x 10mm square holes in the replacement plate.

Remove the top cover of the burner to expose the combustion fan.

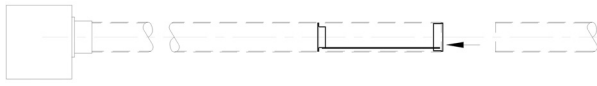
Remove the four screws (arrowed), three of which can not be seen in the photograph. Lift out the fan assembly to access the fan.

Remove the four fixing screws securing the existing orifice plate, then fit the replacement orifice plate with the correct air inlet hole orientation as shown in the picture opposite.



2.2.2.2 Burner Inserts

The burner insert (when required) is inserted into the first heat exchanger emitter tube from where it is joined to the second emitter tube.

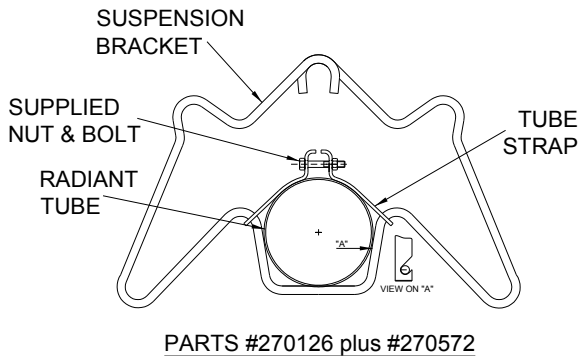


2.2.3 Brackets

There can be various styles of brackets supplied with these heaters:

2.2.3.1 Suspension Brackets

2.2.3.1.1 Fixed suspension bracket assembly part #270126 & tube straps part #270572. **ONLY** used as the first suspension bracket positioned **CLOSEST TO THE BURNER**.



Slip the suspension first bracket assembly - part #270126 onto the first section of emitter tube in the position as indicated on the assembly drawing.

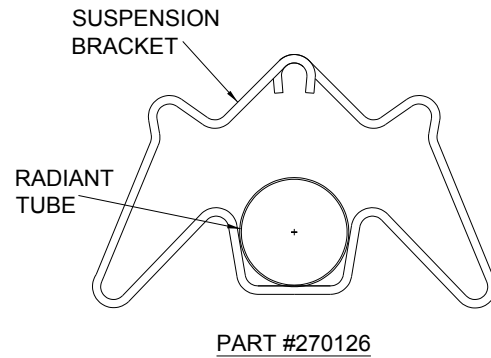
Locate the tube strap assembly part #270572 and loosen the nut and bolt.

Position the strap over the emitter tube and hook the two straps onto the suspension bracket.

Finally tighten the nut and bolt to secure the bracket onto the emitter tube.

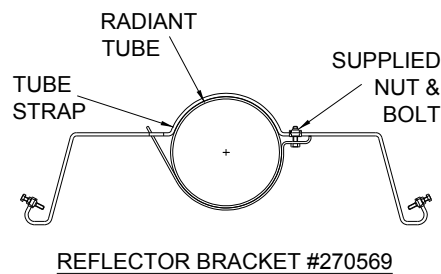
2.2.3.1.2 Suspension brackets #270126 with no tube straps. For **ALL** other suspension brackets

Once the emitter tubes have been assembled using the couplers (see section 2.2.4), position all other suspension brackets part #270126 onto the emitter tube(s) in their relevant positions as shown on the assembly drawing.



2.2.3.2 Reflector Support Brackets

Reflectors are positioned above the emitter tube with a reflector support bracket part #270569.



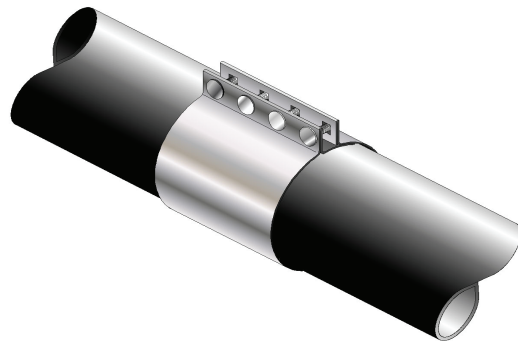
Locate a suspension support bracket and remove the bolt fixing the strap to the bracket.

Position the bracket over the emitter tube and loosely replace the bolt.

Roughly position the support brackets in place along the emitter tube assembly as indicated on the assembly drawing. The positioning may need to be adjusted when the reflector is added.

2.2.4 Couplers

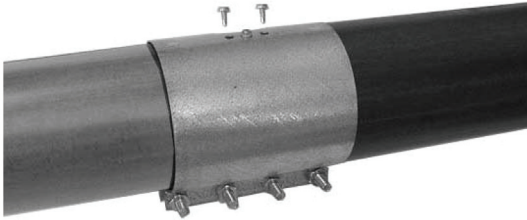
The couplers are used for joining emitter tubes and U or L bends.



Slide the coupling onto the end of the existing emitter tube. Slide the end of the next emitter tube into the other side of the coupling.

With both emitter tube ends pushed fully into the coupling and the bolts towards the bottom, using a 9/16" wrench, tighten the coupling bolts moving between each bolt in sequence to ensure equal pressure is applied to each bolt.

Complete assembly by drilling and screwing self tapping retention zip screws.



! At this point raise the tube assembly into position and suspend from previously fixed chains (Working Load 100lb). Longer tube assemblies may be raised in more than one sub-assembly with the final emitter tube connection made in the air.

2.2.5 Reflectors.

! All reflectors must be positioned/ attached to the brackets exactly as detailed in the assembly drawings.

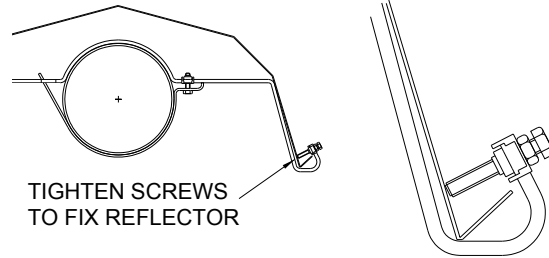
After removing the coloured protective plastic coating (where fitted), slip the reflectors through the suspension brackets until they overlap each other.

The first two reflectors are assembled and overlapped by a pre determined distance, as shown on the assembly drawing, and are fixed onto the emitter tube using the reflector support bracket part #270569.

! Each reflector must **OVERLAP** the previous one as indicated by their individual assembly sheets.

Reposition the reflector support bracket if necessary then tighten the clamp bolt.

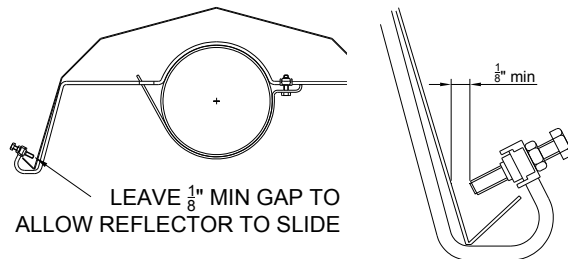
These two reflectors are fixed in place by tightening the fixing screws/locknuts as below. These are known as 'non-slip' overlaps.



The next reflector is assembled and overlapped by the pre determined distance. The reflector is fitted onto the emitter tube using another reflector support bracket part #270569.

Reposition the reflector support bracket if necessary, then tighten the clamp bolt.

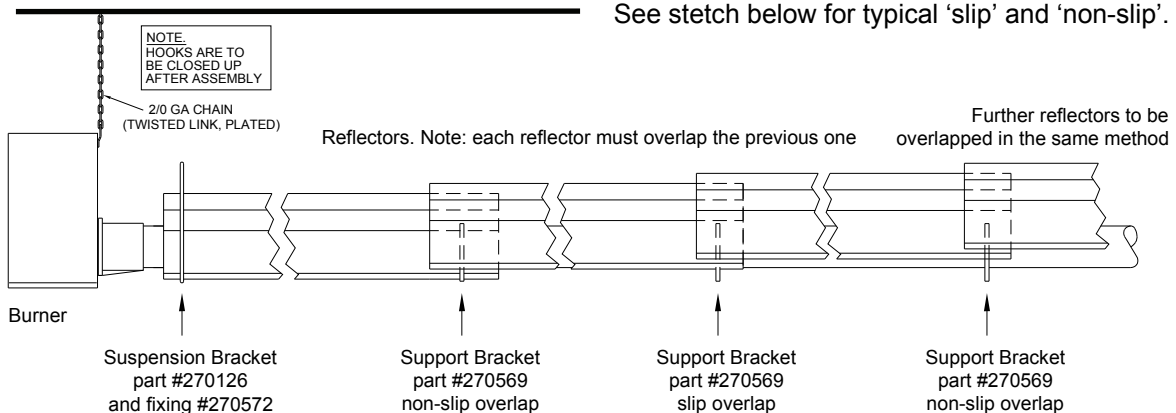
These overlapped reflectors are allowed to 'float' within the support bracket by leaving a minimum of 1/8" gap of the fixing screws before tightening the locknuts. These are known as 'slip' overlaps.



Further reflectors are assembled and overlapped onto the emitter tube by alternating 'non-slip' and 'slip' until complete length is covered.

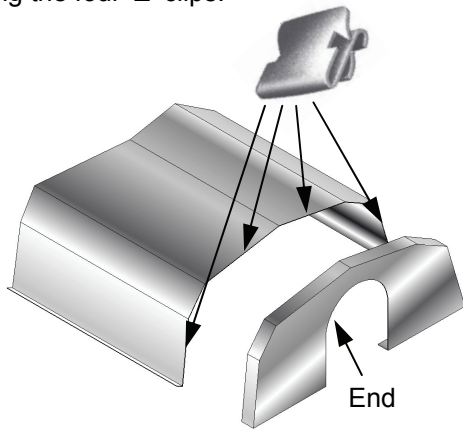
Continue this method to the final reflector/ support bracket.

See stretch below for typical 'slip' and 'non-slip'.



2.2.6 End Caps (optional)

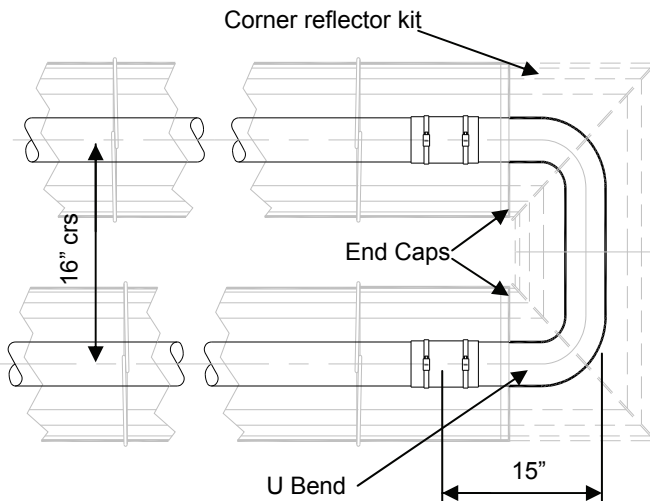
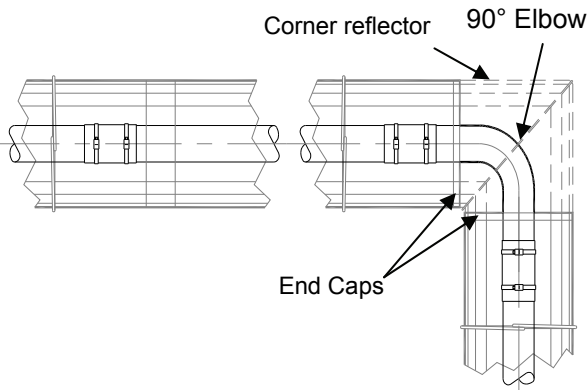
Position an end cap beneath the reflector profile (where required) with the end cap flanges facing inwards. Fasten to reflector using the four 'Z' clips.



2.2.7 Bend(s) (where fitted)

The heater can be installed with 1 or 2 90° bends or a 180° U bend.

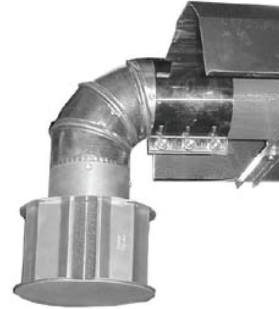
Slide the bend into the open end of the coupler ensuring that the screw stop has butted up to the emitter tube ends. Refer to 2.2.4 for fastening.



2.2.8 Burner/Fan Assembly.

Slide the burner assembly onto the open emitter tube end, ensuring it is fully engaged. Secure with set screws.

For the purpose of unvented applications, a 4" 90° elbow should be used on the terminating end of the emitter tube sections and completed using a vent cap.



Connect Gas and Electrical supplies as described in sections 1.4 and 1.5.

2.2.9 Detailed Assembly Drawings

The following pages show the technical dimensional details for the range of heaters available.

Please note the heater type, length and reference number from the delivery/advice note before identifying the correct model drawing.

Figure 8. Possible Heater Orientations

⚠ Bends must be fitted at a distance of at least 50% of the total heat exchanger e.g. for a 60ft long heater, the closest to the burner a bend can be is 30ft.


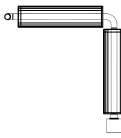


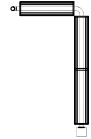


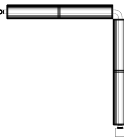
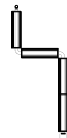

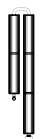

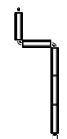


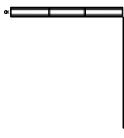
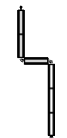

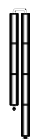

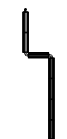
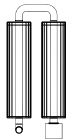

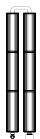
S20				
S30				
S40				
S50				
S60				
S70				
U20				
U40				
U60				

Figure 9. Heater Assembly: Model Linear 60-S20.

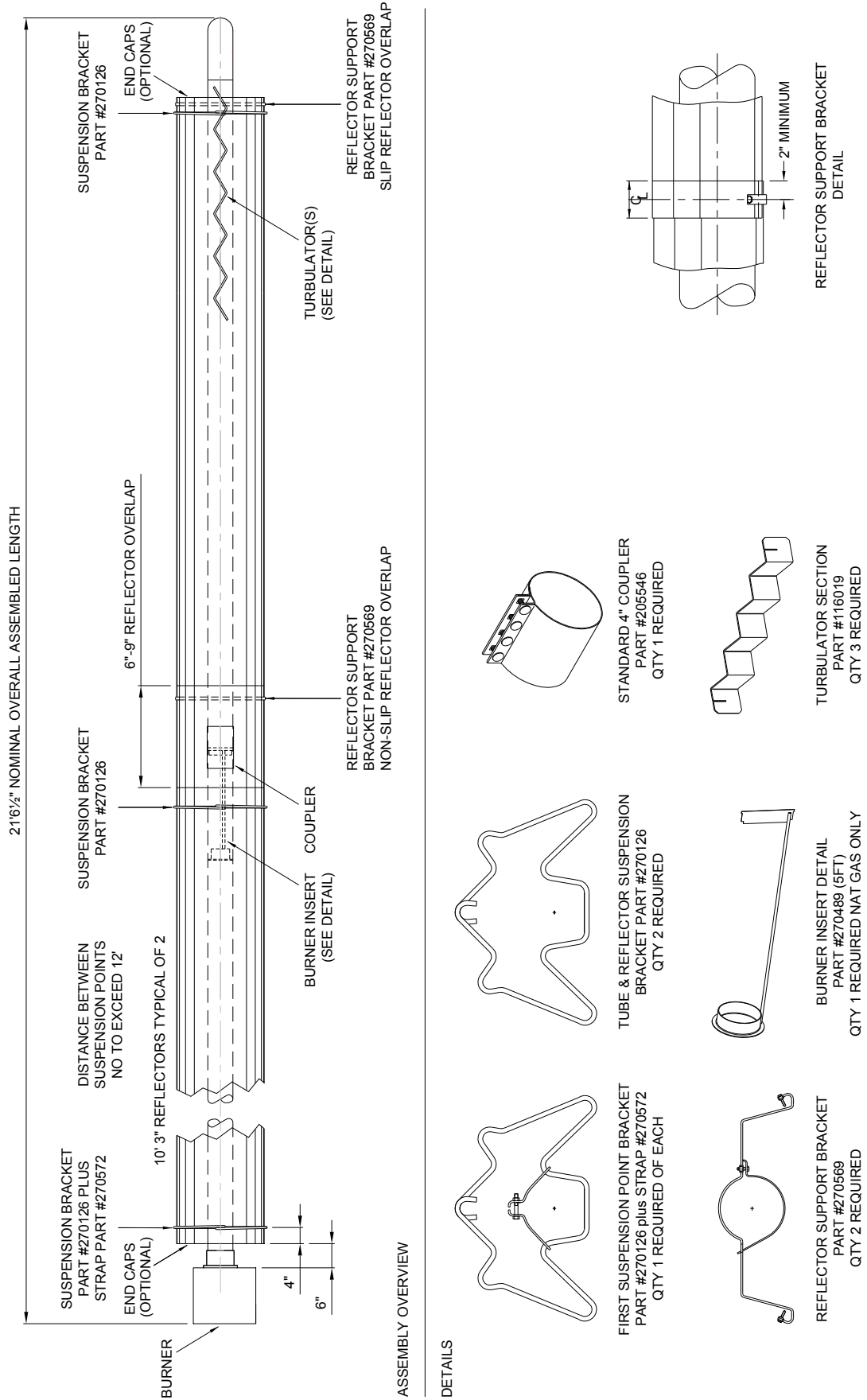


Figure 11. Heater Assembly: Model Linear 60-S40, 80-S40, 100-S40, 125-S40 and 150-S40.

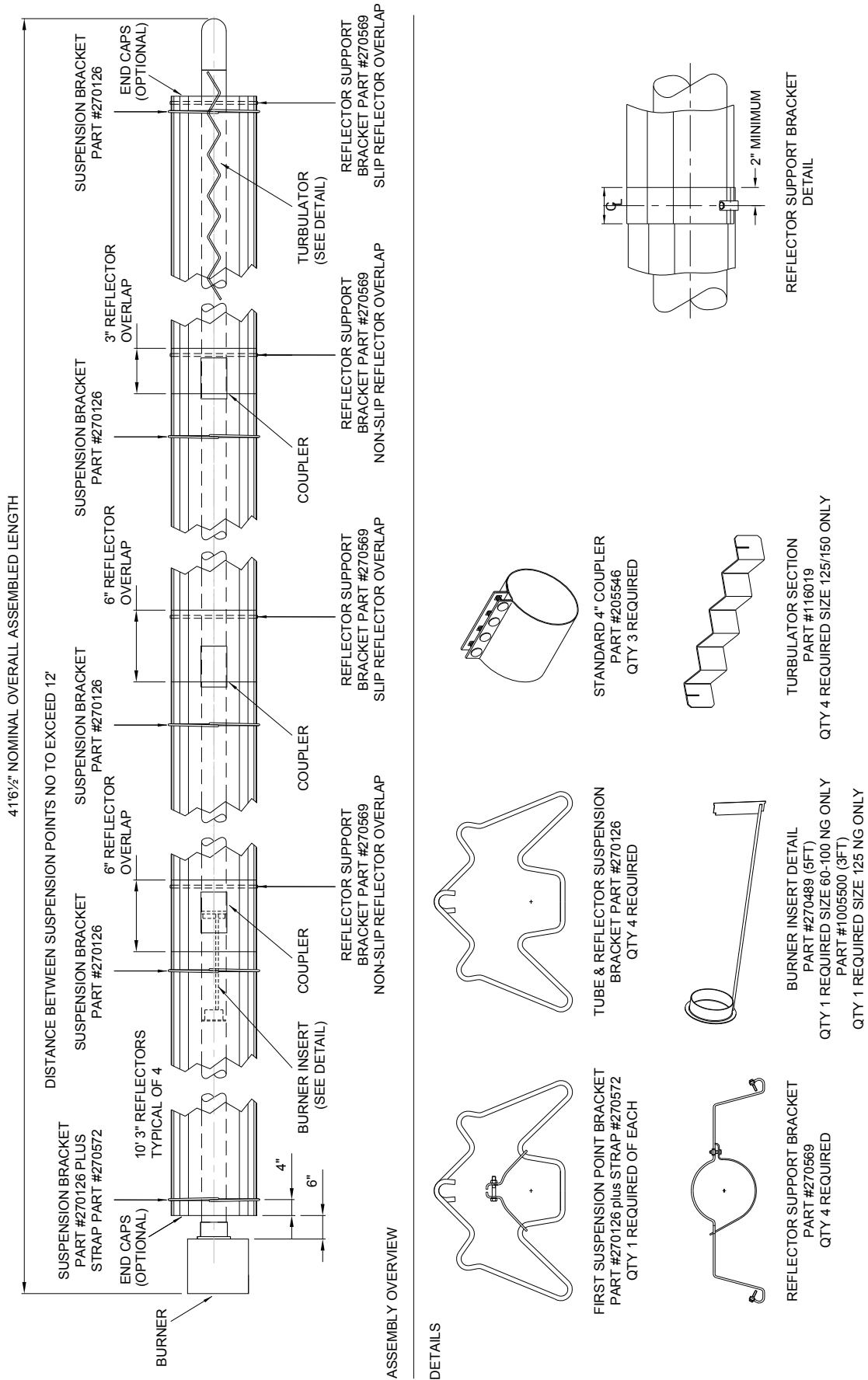
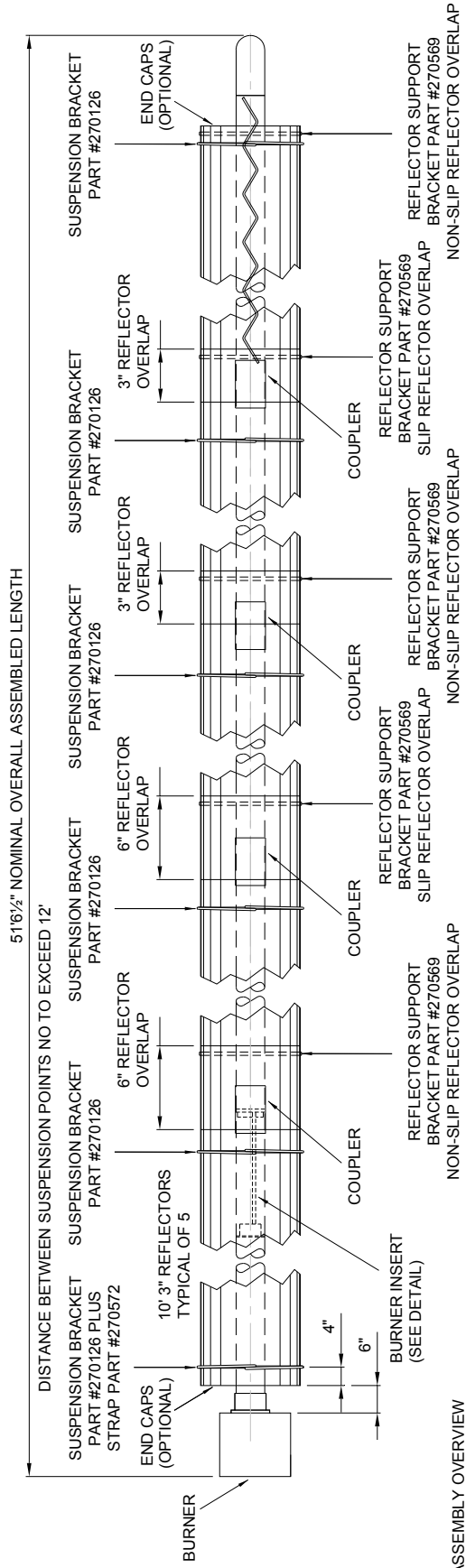
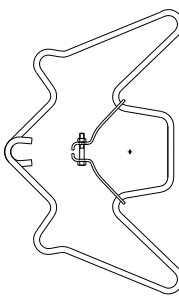


Figure 12. Heater Assembly: Model Linear 125-S50, 150-S50, 170-S50 and 200-S50

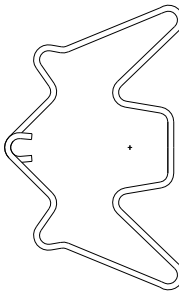


ASSEMBLY OVERVIEW

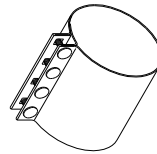
DETAILS



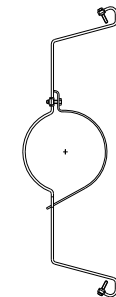
FIRST SUSPENSION POINT BRACKET
PART #270126 plus STRAP #270572
QTY 1 REQUIRED OF EACH



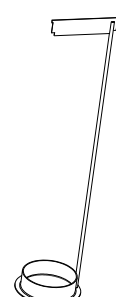
TUBE & REFLECTOR SUSPENSION
BRACKET PART #270126
QTY 5 REQUIRED



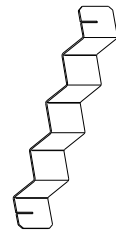
STANDARD 4" COUPLER
PART #205546
QTY 4 REQUIRED



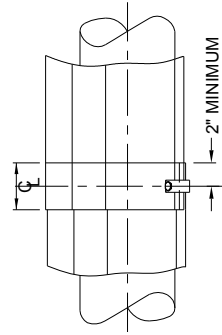
REFLECTOR SUPPORT BRACKET
PART #270569
QTY 5 REQUIRED



BURNER INSERT DETAIL
PART #270489 (5FT)
QTY 1 REQUIRED SIZE 100 NG ONLY
PART #1005500 (3FT)
QTY 1 REQUIRED SIZE 125 NG ONLY



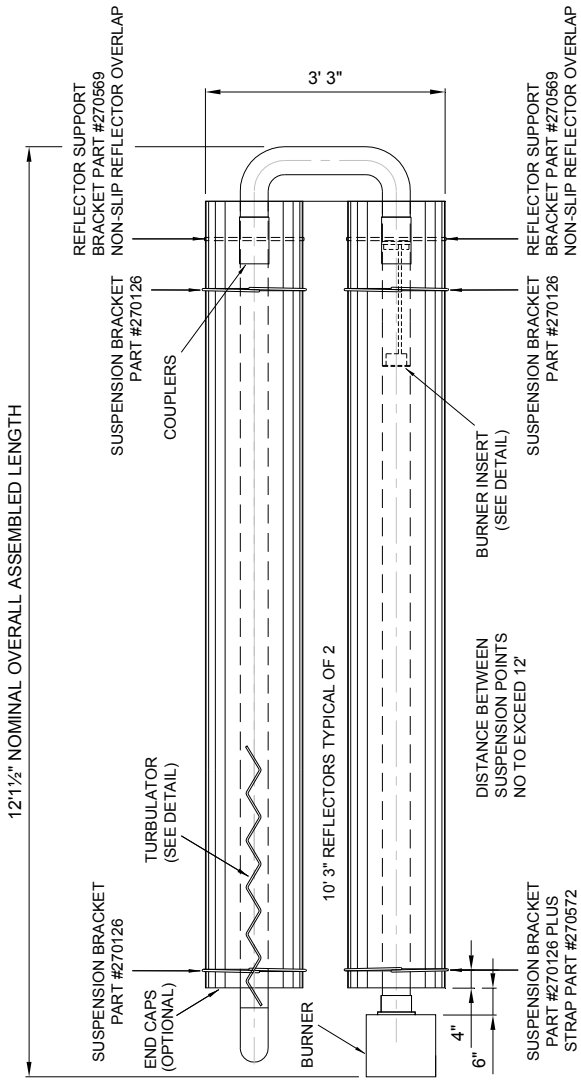
TURBULATOR SECTION
PART #116019
QTY 4 REQUIRED SIZE 200 NG ONLY
QTY 2 REQUIRED SIZE 200 LPG ONLY



REFLECTOR SUPPORT BRACKET
DETAIL

NOTE: The 200 S50 model requires a different fan orifice plate. See P16 for details.

Figure 15. Heater Assembly: Model U tube 60-U20.



12'1/2" NOMINAL OVERALL ASSEMBLED LENGTH

3' 3"

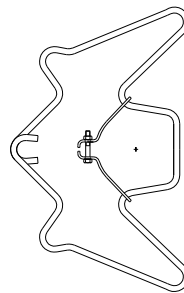
DISTANCE BETWEEN SUSPENSION POINTS NO TO EXCEED 12'

4"

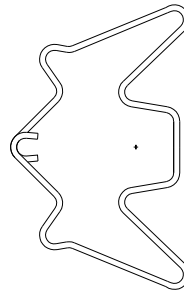
6"

ASSEMBLY OVERVIEW

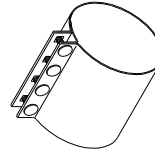
DETAILS



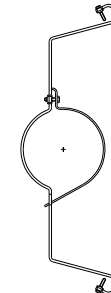
FIRST SUSPENSION POINT BRACKET
PART #270126 plus STRAP #270572
QTY 1 REQUIRED OF EACH



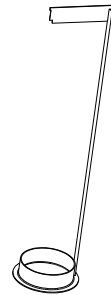
TUBE & REFLECTOR SUSPENSION
BRACKET PART #270126
QTY 3 REQUIRED



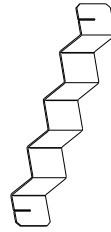
STANDARD 4" COUPLER
PART #205546
QTY 2 REQUIRED



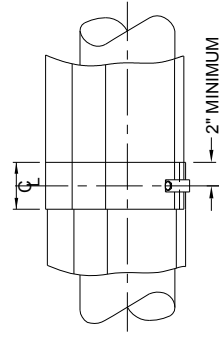
REFLECTOR SUPPORT BRACKET
PART #270569
QTY 2 REQUIRED



BURNER INSERT DETAIL
PART #270489 (5FT)
QTY 1 REQUIRED NAT GAS ONLY



TURBULATOR SECTION
PART #116019
QTY 1 REQUIRED SIZE 60 ONLY



REFLECTOR SUPPORT BRACKET
DETAIL
2" MINIMUM

Figure 16. Heater Assembly: Model U tube 60-U40, 80-U40, 100-U40, 125-U40 and 150-U40.

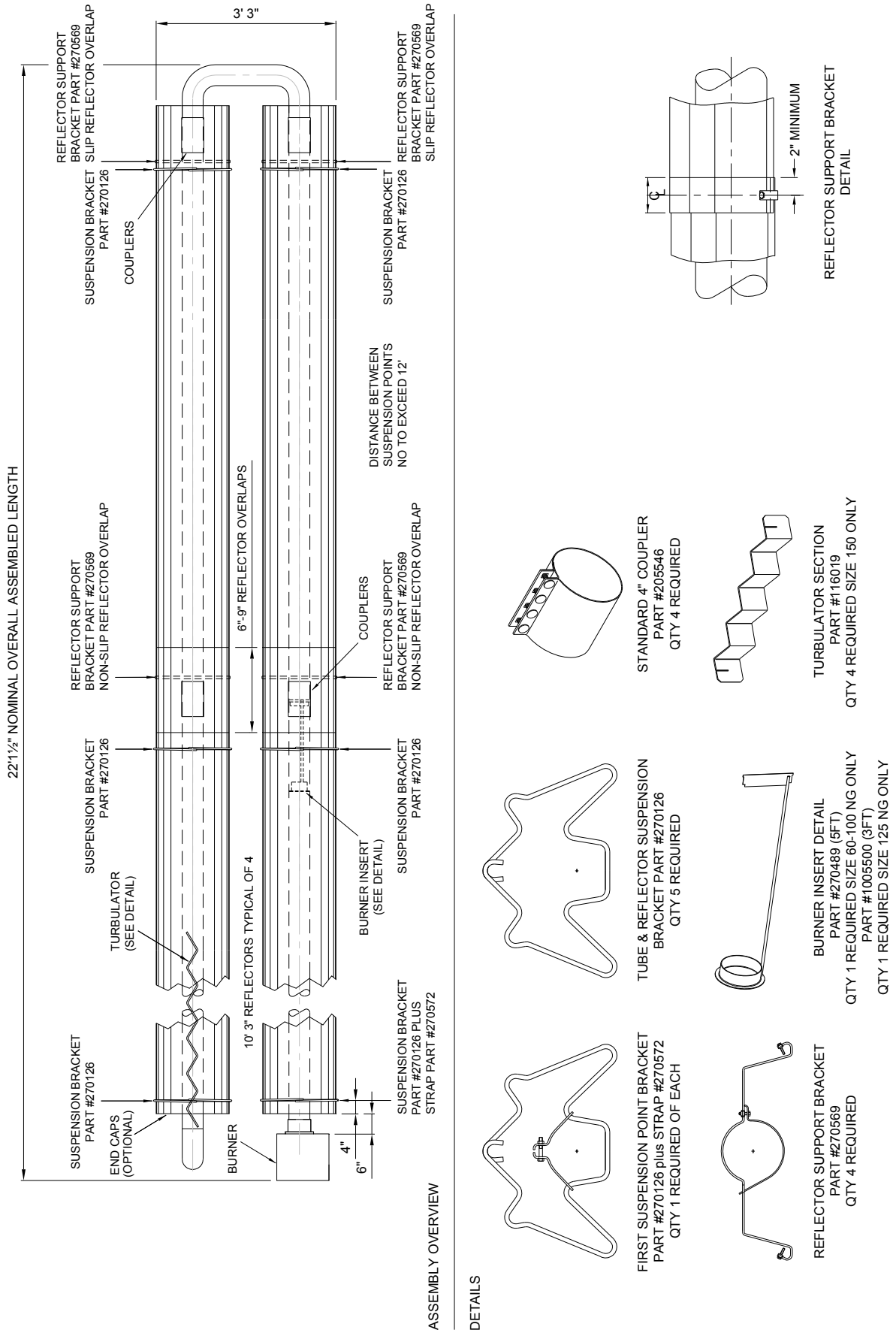
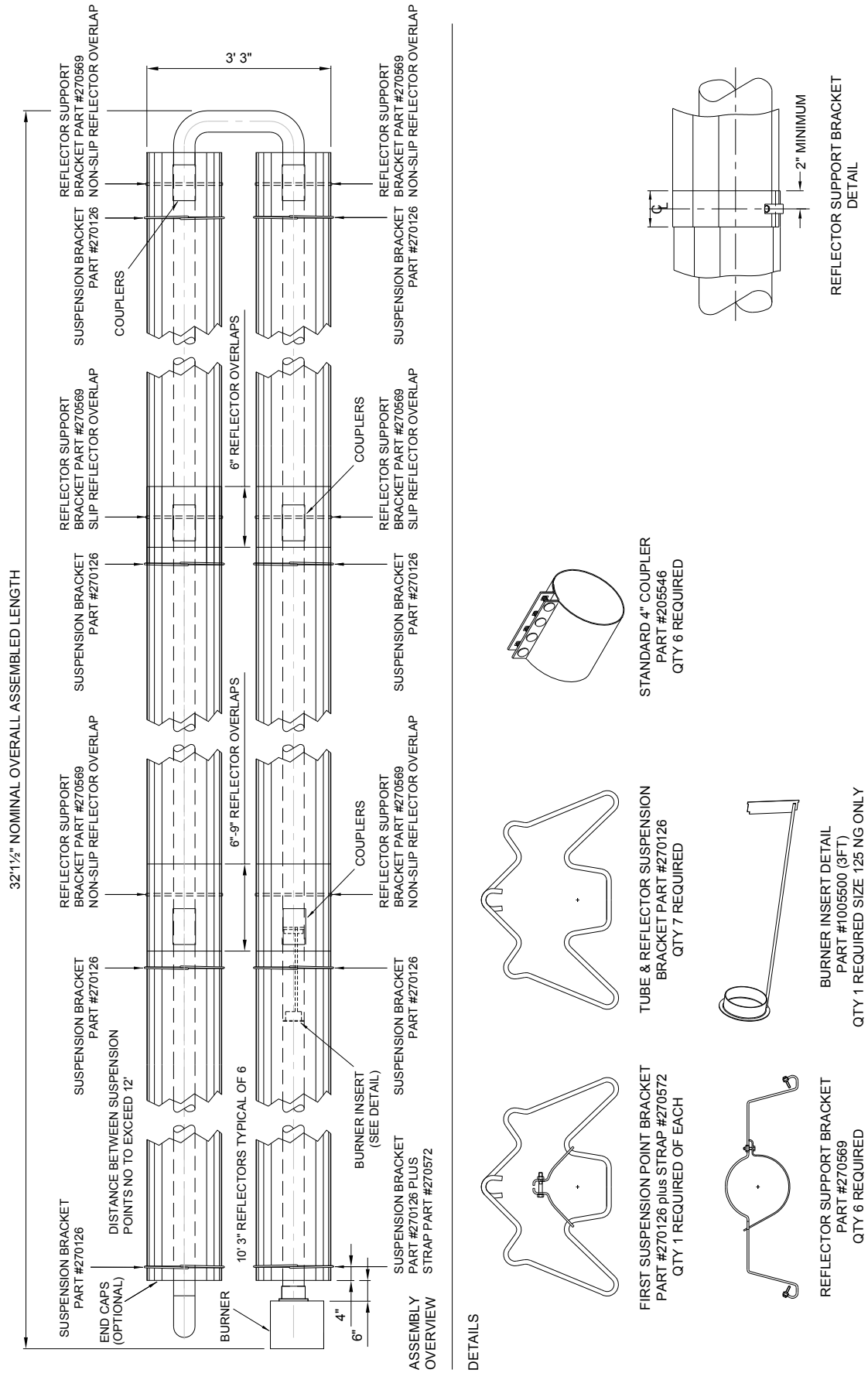


Figure 17. Heater Assembly: Model U tube 150-U60, 170-U60 and 200-U60.



3. Start Up Instructions.



These appliances should be commissioned by a qualified mechanical contractor.

3.1 Tools Required.

The following tools and equipment are advisable to complete the tasks laid out in this manual.



Suitable alternative tools may be used.



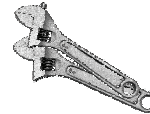
Leather Faced Gloves



Phillips Screwdriver



Small Flat Head Screwdriver



Large Adjustable Wrenches for fitting Of Gas Flex.



1/2" Wrench



5/32" (4mm) Allen Wrench



Manometer



Multimeter

3.2 Start Up Procedure

Inspect installation and ensure that it has been carried out in accordance with these instructions. Ensure that electrical and gas supplies are isolated.

The gas supply should be purged and tested for leaks in accordance with local and National Safety codes.

Open shut off gas valve and test gas connections for leaks using soap solution.

Open the control housing door by unscrewing the securing screw. Ensure all internal components are securely fixed and all connections securely made.

Switch on the electrical supply to start the heater and observe the correct start up sequence. Ensure that the setting of any time clock and thermostat are such that the heating system will be required to operate.

The fan will start to run and the 'power on' lamp will illuminate. Safe-start checks are carried out automatically.

After the fan has run up to full speed and a satisfactory vent pressure condition has been established, the ignition sequence will commence. The spark ignition will be energized producing a spark at the ignition electrode. The gas solenoid valve will energize at the same time and the 'burner on' lamp will illuminate. If the ignition is successful, the flame is detected by the flame sensing probe and the 'burner on' lamp will remain on.

If ignition is unsuccessful, after approximately 15 seconds the gas valve will close and the spark ignition will de-energize.

For approximately 30 seconds the fan will purge the system, then re-ignition will be attempted. After 2 further attempts at ignition the control unit will 'lock-out', the 'power on' lamp will remain illuminated and the fan will run for 120 seconds and then stop.

To reset after 'lockout' switch off the power supply to the system and wait 2 minutes. Then turn the power on. If repeated 'lockout' occurs, investigate the cause.

Set burner gas pressure as follows:

Switch off the power supply to the heating system.

Connect a 'U' tube or digital manometer to the pressure test point provided on the combination gas control valve.

Remove the cover from the pressure regulator to reveal the adjusting screw.

Start the heater and using a suitable screwdriver adjust the pressure regulator, turning the screw clockwise to increase the pressure or counter-clockwise to decrease the pressure.

Set the pressure to appropriate inches w.c. from the table of gas pressures and orifice plate dimensions for correct heater description. (See section 1.8 page 13)

The high fire gas pressure should be set first followed by the low fire gas pressure. Re-check the high fire and re-adjust if necessary.

To enable post purge ensure that the setting of any time switch and thermostat are such that the heating system will be required to turn off.

Switch off the power supply to the heating system. Disconnect manometer, then secure screw in pressure test nipple.

Check the operation of the flame safeguard equipment as follows:

With the heater running normally, switch off the gas supply at the shut off valve. The heater should attempt to relight then 'lock-out' should occur. This is indicated by the 'power on' lamp being illuminated and fan running, but the 'burner on' lamp being off.

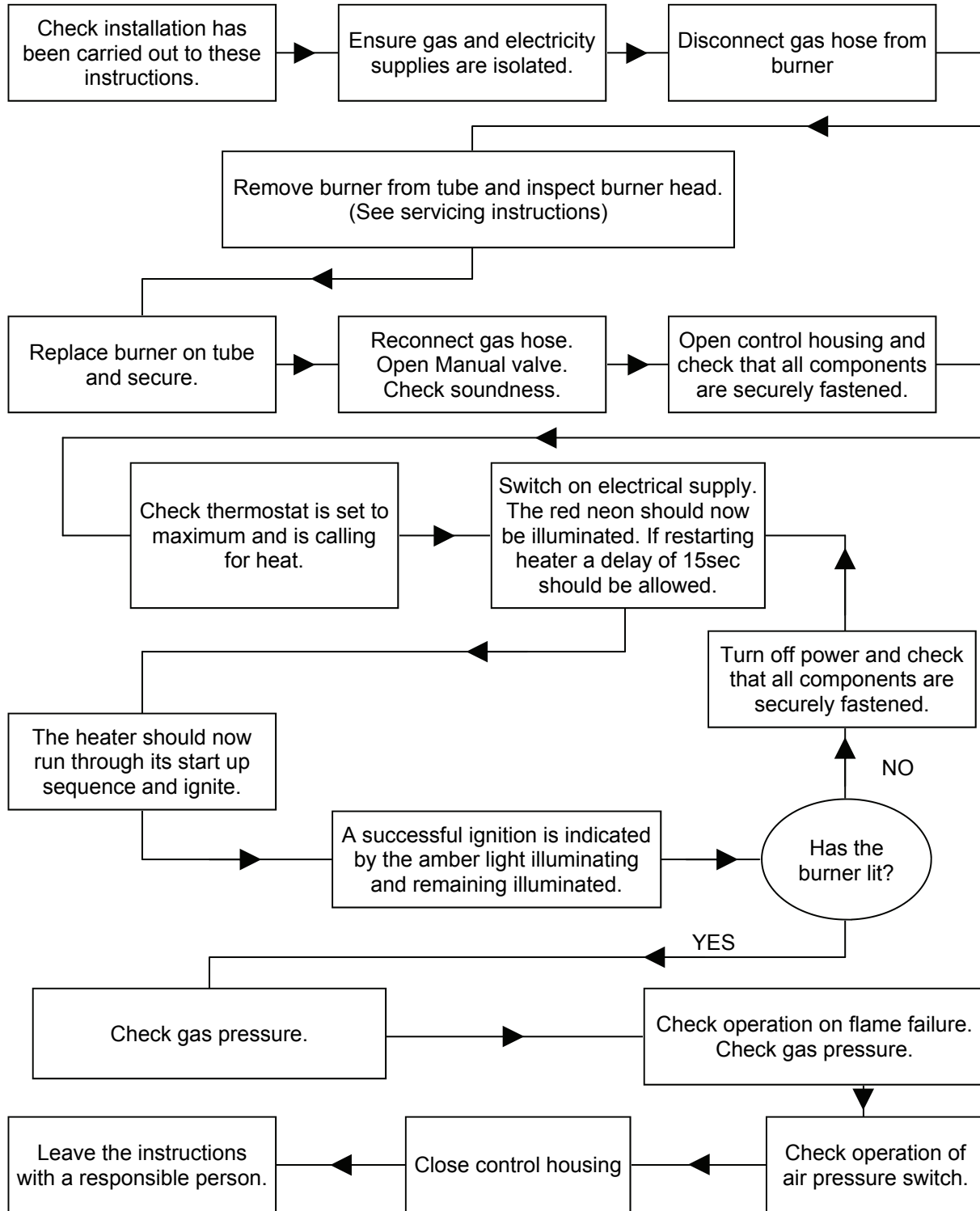
Check the operation of the pressure proving switch as follows:

With the heater running normally, pull off the silicone rubber tube connecting the vacuum switch to the combustion chamber. The burner should shut off within 4 seconds .

Replace the tube securely and observe that the heater proceeds to ignite in the normal way.

Close the controls door and secure with the screw.

Commissioning chart



4. Servicing Instructions.

⚠ These appliances should be serviced annually by a competent person to ensure safe and efficient operation. In mildly dusty or polluted conditions more frequent servicing may be required. Servicing work should be carried out by a qualified mechanical contractor.

4.1 Tools Required.

The following tools and equipment are advisable

to complete the tasks laid out in this manual.

i Suitable alternative tools may be used.



Leather Faced Gloves



Phillips Screwdriver



Small Flat Head Screwdriver



Large Adjustable wrenches for fitting of Gas Flex.



1/2" Wrench



5/32" (4mm) Allen Wrench



Manometer



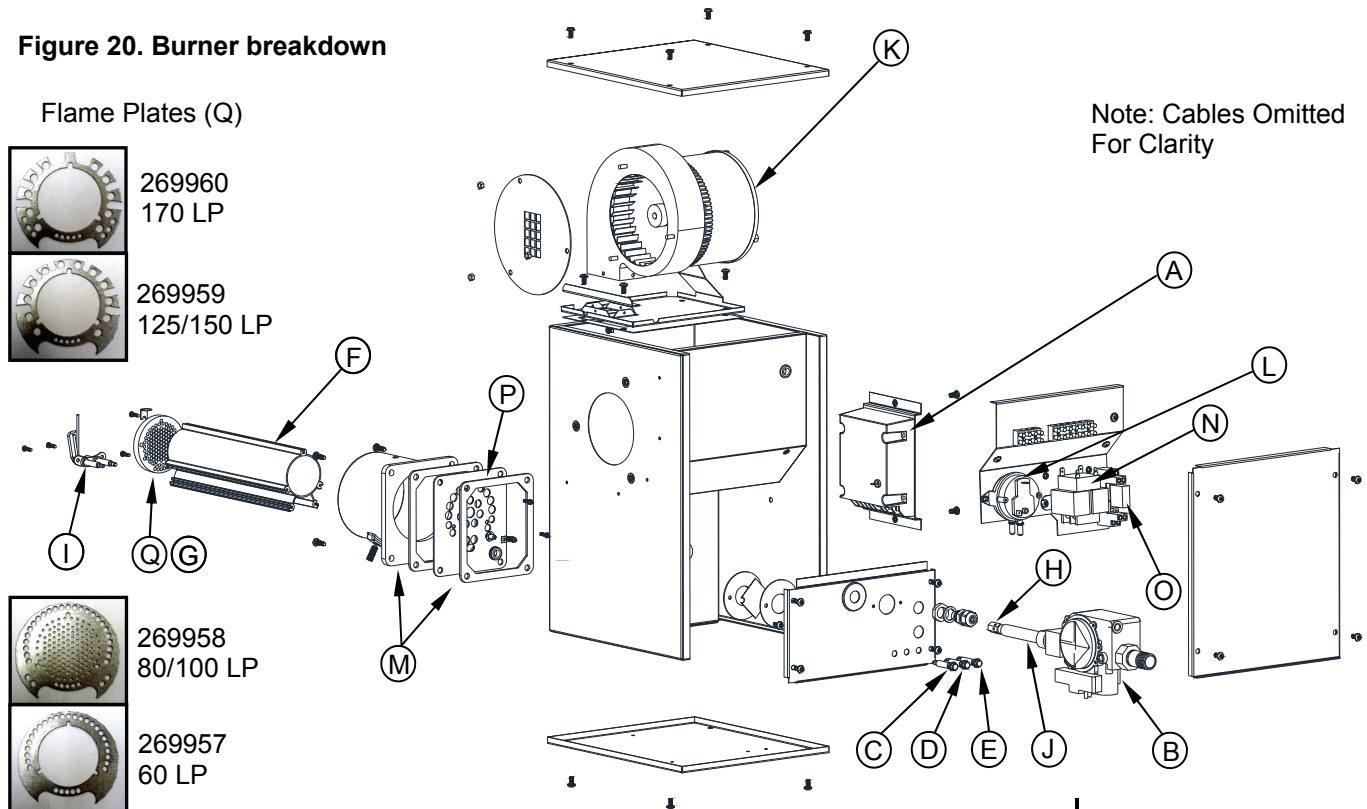
Multimeter



Soft Brush

4.2 Burner Description.

Figure 20. Burner breakdown



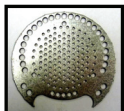
Flame Plates (Q)



269960
170 LP



269959
125/150 LP



269958
80/100 LP




269957
60 LP

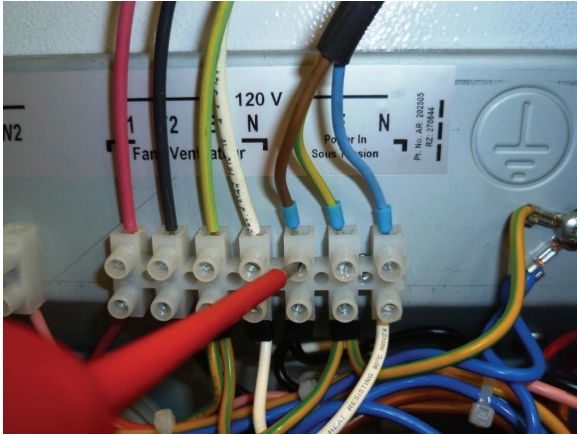
	Part Number
A	Ignition Controller 204955
B	Gas Valve 270373 (NG) 270498 (LP)
C	Power On Red Lamp 270474
D	Low Fire Amber Lamp 270473
E	High Fire Amber Lamp 270473
F	Burner Tube 270424
G	Burner head 270425
H	Injector See section 1.8 P14

	Part Number
I	Igniter Assembly 270441
J	Injector Carrier See section 1.8 P14
K	Combustion Fan See section 1.8 P14
L	Pressure Switch See section 1.8 P14
M	Gaskets 2 off 270366
N	Transformer 194808
O	24V Relay 270472
P	Burner Orifice Plate See section 1.8 P14
Q	Flame Plate (not shown) See photos above

4.3 Burner Removal

 **Step 1:** Isolate power and gas supplies.

Step 2: Disconnect the external power/control connections.



Step 3: Detach the gas supply as shown below, taking care to support the burner connection.



Step 4: If ducted air is connected, loosen hose clip and remove the flexible hose from the burner.



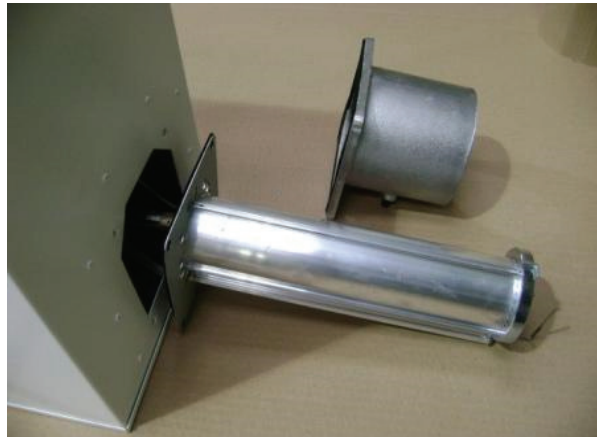
Step 5: Loosen the set screw on the burner support casting to enable the burner to be removed from the radiant tube.



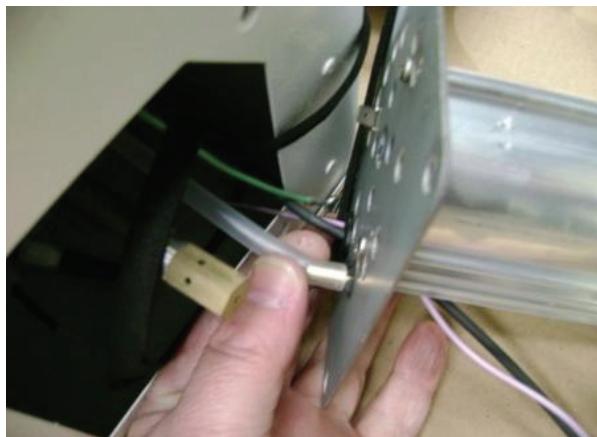
Step 6: Remove the burner and position the burner in a safe area to prevent the burner or components attached to the burner from falling to the ground.

4.4 Burner Gas Injector Servicing

Step 1: Remove the 4 retaining screws, then remove the burner support casting and gasket.



Step 2: The burner head assembly can be disconnected by separating the connectors of the ignition lead assembly and removing the earth lead and pressure switch silicon tube.



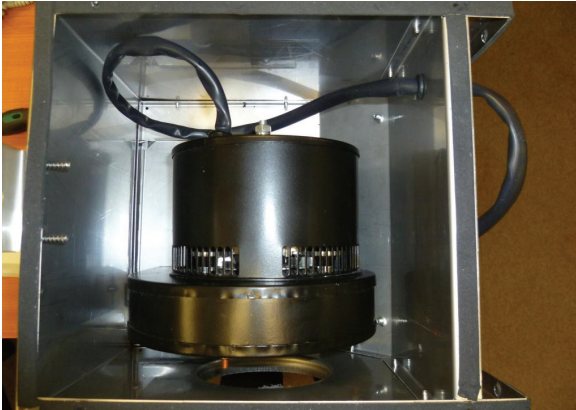
Step 3: The gas injector can be inspected and replaced if contaminated or blocked.

When replacing the gas injector ensure approved thread sealant is used.

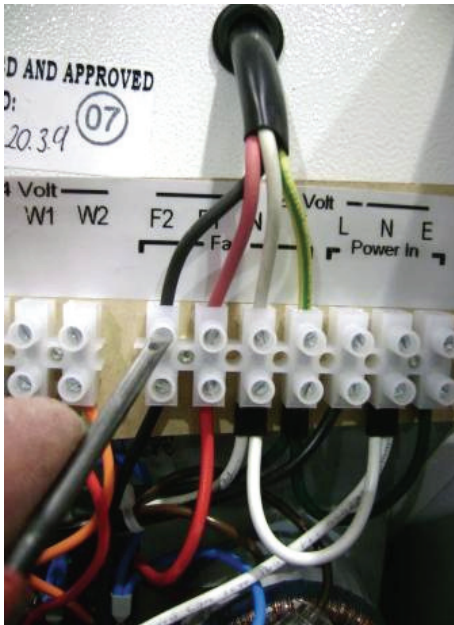
Step 4: Reconnect ignition leads and silicone tube to test nipple. Refit gasket and support casting.

4.5 Combustion Fan Servicing

Step 1: Remove the four top lid screws to reveal the combustion fan shown below.



Step 2: Disconnect the fan cables after first noting their positions, then pull cable through to fan compartment.



Step 3: Remove the four fan fixing screws then withdraw the fan complete with mounting bracket as shown below.



Step 4: Remove fan orifice plate.

Step 5: Inspect the impeller and remove any dust with a soft brush.

Step 6: Remove any dust from fan scroll and from around the motor.

Step 7: Ensure the impeller rotates freely.

Step 8: Refit components.

4.6 Burner Head and Electrode Servicing

Step 1: Check the pepper pot burner head for contamination. If necessary this can be removed. See below.



This can be cleaned together with the inside of the burner head.

Step 2: The pepper pot burner head can be replaced ensuring the 5 holes on the outer ring are aligned alongside the probes.

Step 3: The condition of the igniter assembly can be checked for deterioration. However, we advise replacement at each service to ensure

continued reliability. Detach the electrode assembly from the burner head by removing the two screws as shown and separating the igniter assembly lead connectors.

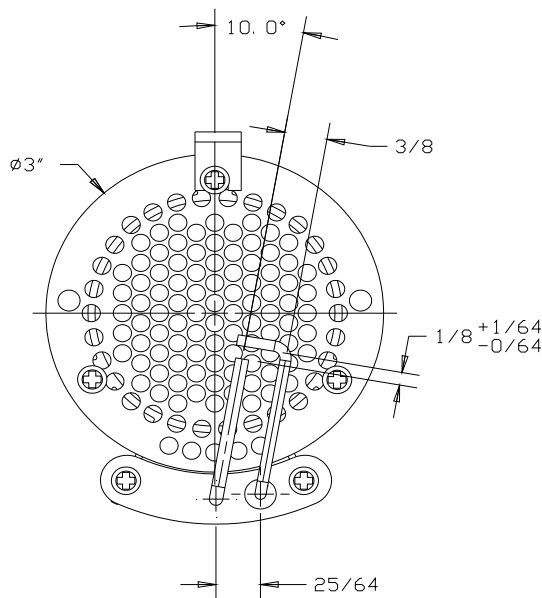
Step 4: Refit the electrode assembly and ensure the connections are secure to prevent incorrect sparking of the spark electrode.



Step 5: Check the positions and spark gap as shown in diagram below.

Step 6: The burner assembly is ready to refit after servicing the combustion fan and the radiant tube assembly.

Step 7: Refit components.



4.7 Radiant Tube Servicing

Step 1: Brush any dust from the exterior of the tubes.

Step 2: Inspect the fan and burner tubes visually. If the tubes appear clean, skip to servicing the reflector.

Step 3: If required the interior of the tubes can then be cleaned using an industrial vacuum cleaner or by using long poles and a scraper.

4.8 Reflector Servicing

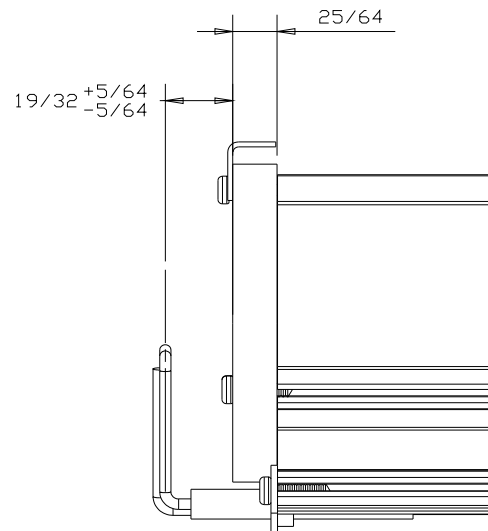
The condition of the reflectors should be noted. If necessary the reflectors can be cleaned with a mild detergent. This can significantly improve the efficiency of the appliance.

4.9 Cleaning of Vent

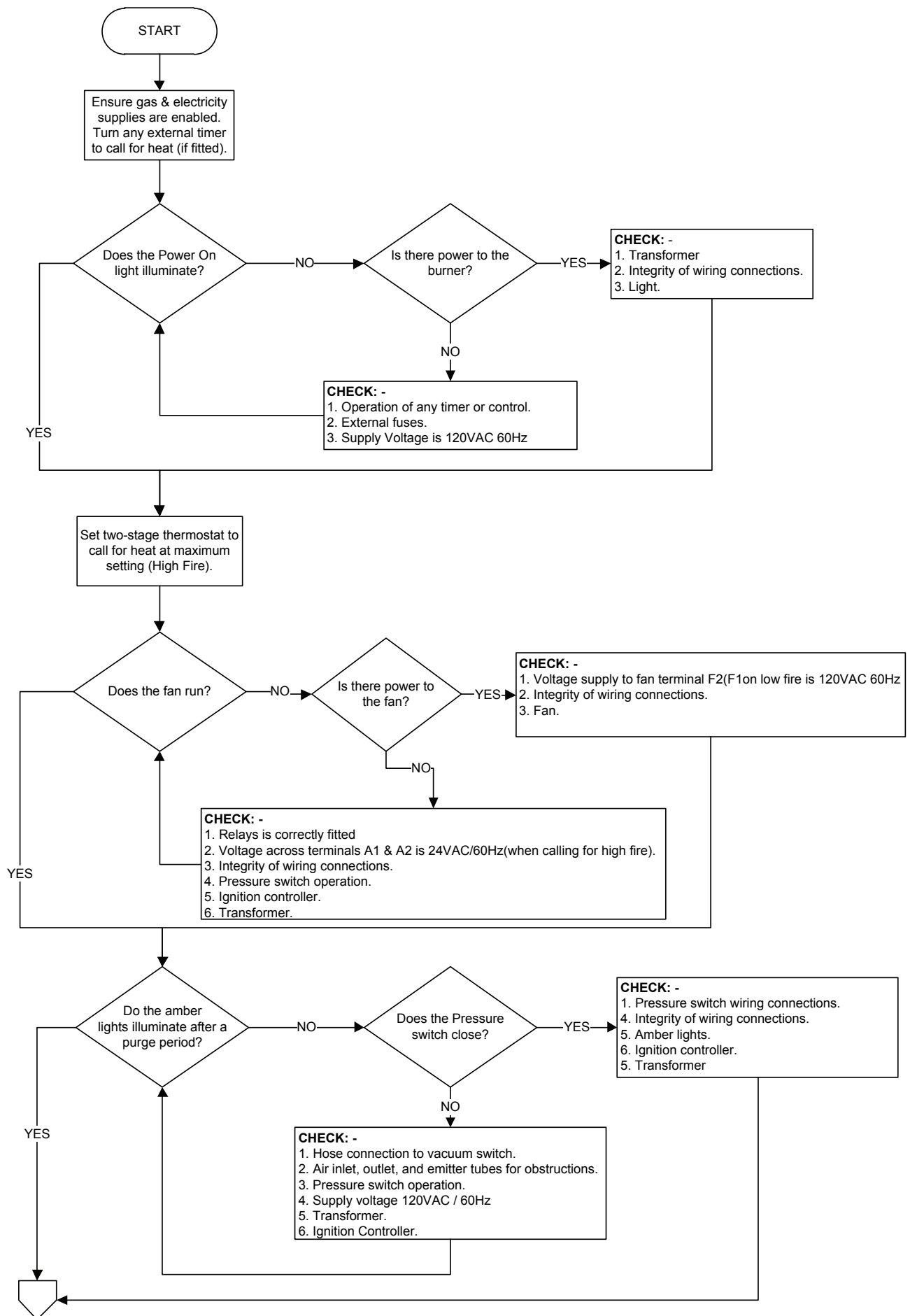
Inspect the fresh air inlet duct and vent to ensure they are free from any blockage or obstruction. The air inlet terminal and vent terminal should be inspected to ensure they are not liable to obstruction.

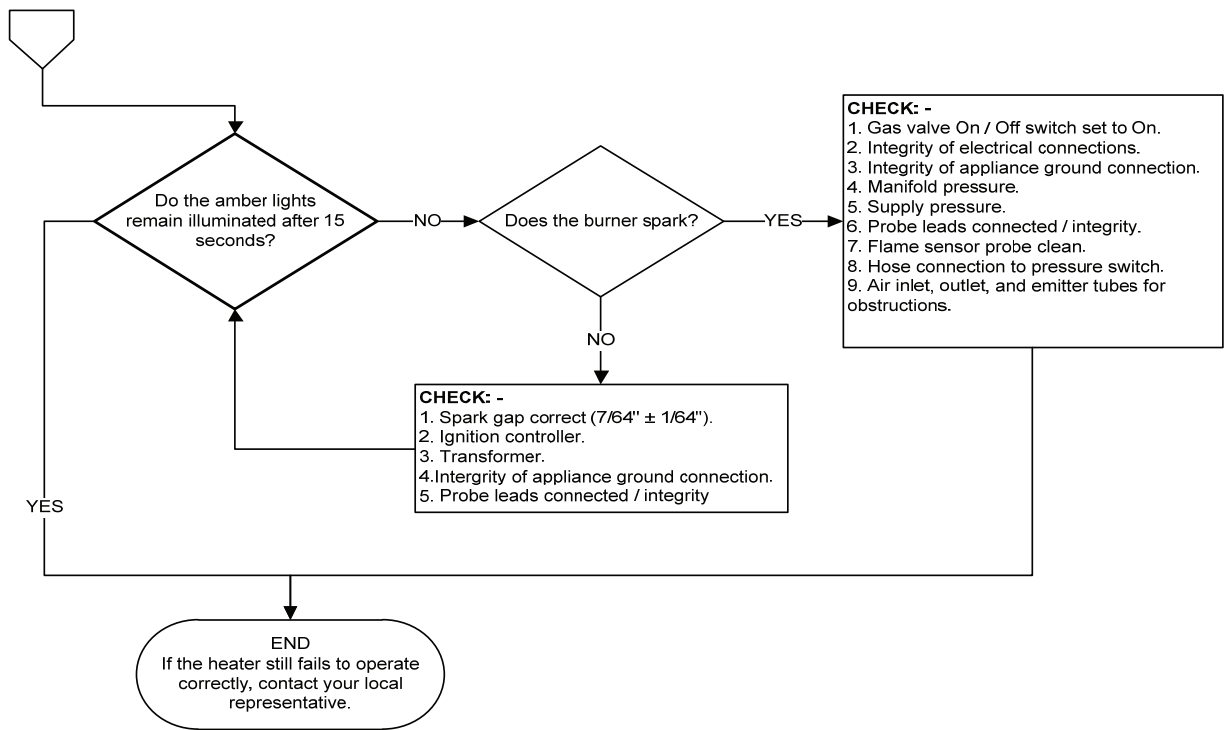
4.10 Re-commissioning After Service

After servicing of the heater has been undertaken, it will be necessary to re-commission the heater as detailed in the commissioning chart in these instructions.



5. Troubleshooting Guide.





**To aid in the trouble shooting process
the UT controller has an LED flash code
diagnostic sequence:**

- Steady Off** No control Power
- Steady On** Power Applied, Control OK
- 1 Flash** Combustion Pressure Switch Open With Blower On
- 2 Flashes** Combustion Pressure Switch Closed With Blower Off
- 3 Flashes** Lockout From The Three Ignition Trials
- 4 Flashes** Lockout From Five Flame Losses
- 5 Flashes** Control Hardware Fault Detected
- 6 Flashes** Lockout From Five Pressure Switch Losses

6. Replacing Parts.

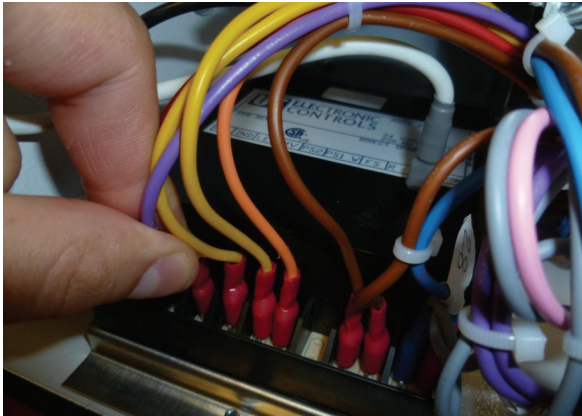


Turn off gas and any electrical supplies to the heater before starting repair work.

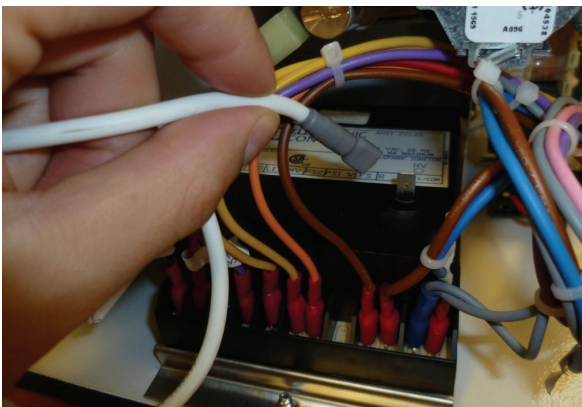
6.1 Burner Controller Replacement

Step 1: Remove the four screws securing the bottom access door.

Step 2: Disconnect burner controller from the wiring harness.



Step 3: Disconnect the Spark Lead from burner controller.



Step 4: Remove burner controller from its retaining screws and remove.

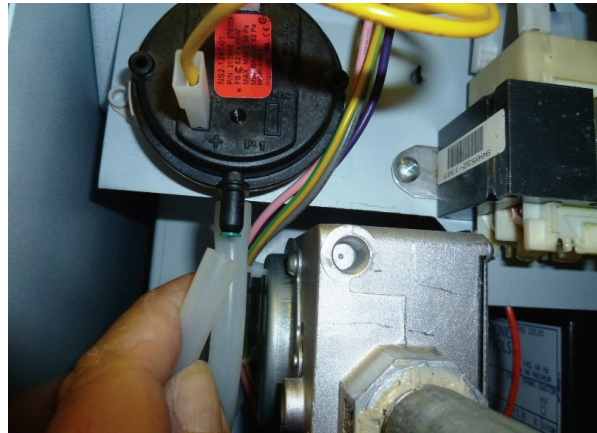
Step 5: Fit new burner controller.

Step 6: Refit spark lead and wiring harness connector.

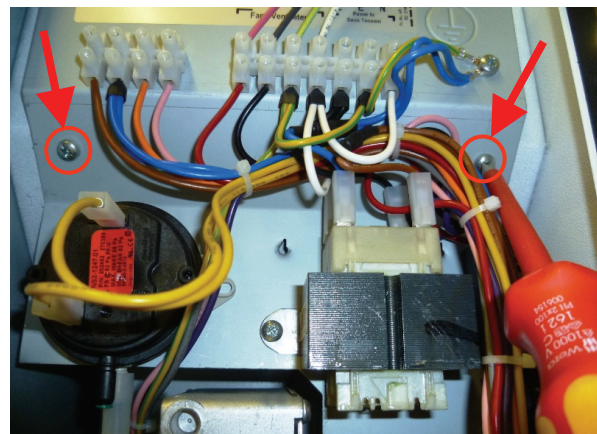
Step 7: Test product and close access door.

6.2 Air Pressure Switch Replacement

Step 1: Disconnect the two silicone tubes from the pressure switch.



Step 2: Remove the two electrical chassis retaining screws arrowed.

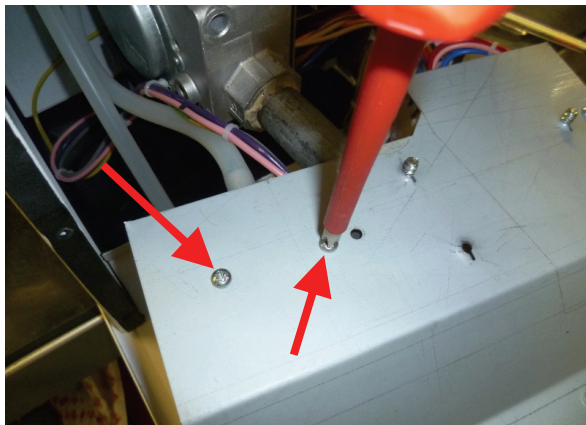


Step 3: Disconnect pressure switch wiring.

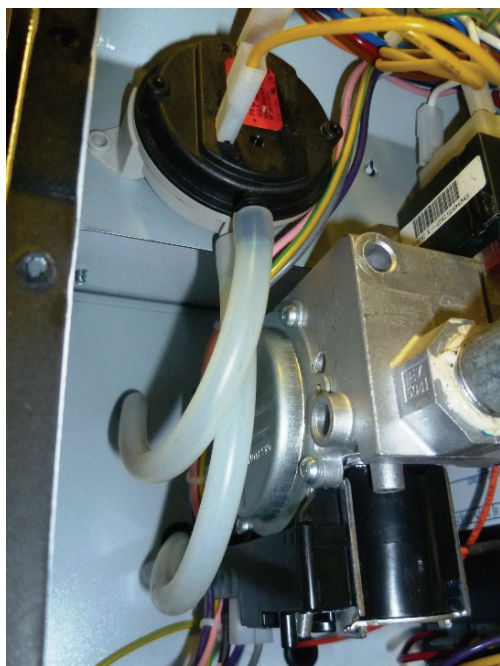


It may be necessary to partially disconnect the chassis wiring to access the pressure switch mounting screws at the rear.

Step 4: Turn chassis over and remove the two pressure switch retaining screws.



Step 5: Fit the new air pressure switch in reverse order ensuring the silicone tubes are connected as shown below.



Step 6: Re-connect wiring.

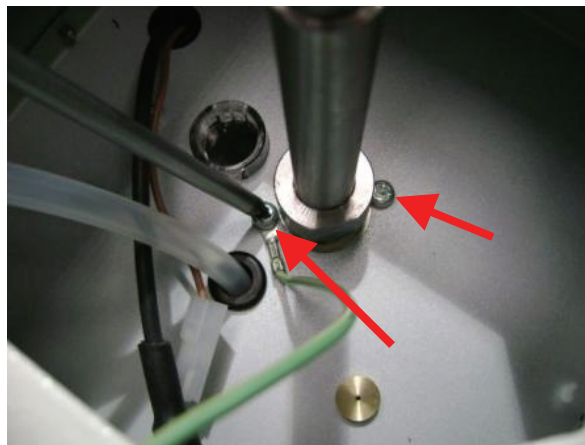
Step 7: Test product and close access door.

6.3 Gas Valve Replacement

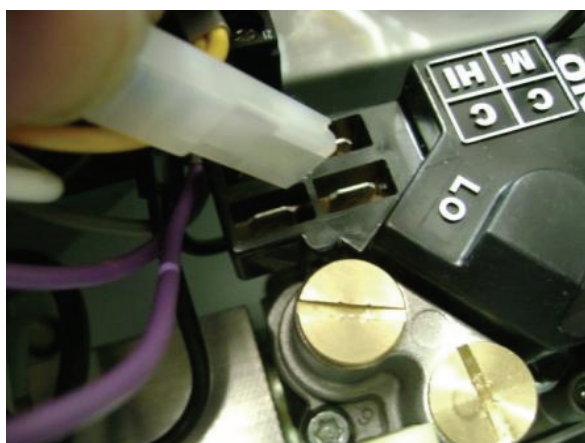
Step 1: Remove the burner assembly as described in the Servicing section.

Step 2: Open the rear access door.

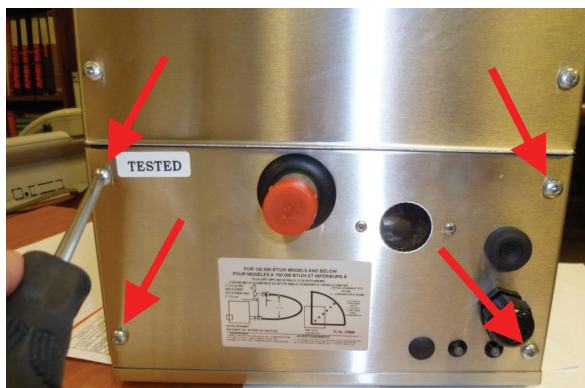
Step 3: Remove the two securing screws (arrowed) from the base of the injector tube, noting earth terminal connection.



Step 4: Remove the gas valve wiring connections, noting their positions.



Step 5: Remove the four screws (arrowed) securing the gas valve inlet plate to the burner housing and remove plate.



Step 6: Remove gas valve rearwards as shown.

Step 7: The jet carrier and gas inlet can now be detached from the gas valve.

Step 8: Replace gas valve and Re-connect wiring.

Step 9: Set burner pressure.

Step 10: Test product and close access door.

7. User & Operating Instructions

Radiant tubular infrared heaters are designed for overhead heating of industrial and commercial buildings. Individual heating units are suspended from the roof.



- 1. This appliance must only be installed by qualified installer in accordance with the requirements of local and National Codes.**
- 2. This appliance must be grounded in accordance with the National Electrical Code ANSI/NFPA No.70 or Canadian Codes.**
- 3. Never rest anything, especially ladders, against the heaters.**

7.1 To Start the Heater

1. First ensure that the gas supply to each heater is turned on by opening the main gas shut off valve.
2. Switch on the electrical supply to the heater. The 'power on' lamp will illuminate.
3. Ensure that the settings of the two stage thermostat and any time switch are set so that the heating system will be required to operate.
4. The fan will start and the ignition sequence will commence.
5. Ignition of the burner will occur and the 'low fire' light only will illuminate for low fire and both the 'low fire' and 'high fire' lights will illuminate for high fire.
6. If ignition is unsuccessful the gas valve will close and the spark ignition de-energize after approximately 15 seconds. For approximately 30 seconds the fan will purge the system then re-ignition will be

attempted. After 3 attempts at ignition the control unit will 'lock-out', the 'power on' lamp will remain illuminated and the fan will continue to run for 120 seconds then stop. To reset after 'lockout', switch off the power supply to the heater and wait 5 minutes. Then turn the power on. If repeated 'lockout' occurs investigate the cause.

7.2. To Switch Off Heater

Ensure that the setting of any time switch and thermostat are such that the heating system will be required to turn off. Switch off electrical supply to the heater. The burner will stop and the fan will shut off.

7.3. Servicing

To ensure continued, efficient and safe operation it is recommended that the heater be serviced regularly by a qualified person every year in normal working environments but in exceptionally dusty or polluted environments more frequent servicing may be needed.