



NORMANDY
PRODUCTS COMPANY

PVC SEWER & DRAIN FITTINGS LIST PRICE SHEET

PRICES EFFECTIVE MARCH 4, 2013



PVC Sewer & Drain Fittings

White Solvent Weld SDR 35

Conforms to ASTM D3034 Effective March 4, 2013

Coupling

(Sewer Hub x Sewer Hub)



Part Number	Size	Ctn Qty	List Price
V-103	3"	50	\$2.31
V-104	4"	50	2.79
V-106	6"	24	10.32

Repair Coupling

(Sewer Hub x Sewer Hub - No Stop)



Part Number	Size	Ctn Qty	List Price
V-144	4"	30	\$3.41

Reducer Coupling

(Sewer Hub x Sewer Hub)

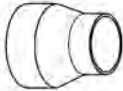

Part Number	Size	Ctn Qty	List Price
V-1043	4 x 3"	40	\$4.41
V-1064	6 x 4"	24	13.88

Adapter Coupling

(Sewer Hub x DWV Hub)



Part Number	Size	Ctn Qty	List Price
V-2043	4 x 3"	40	\$5.19
V-2044	4 x 4"	25	6.90
V-2046	6 x 4"	24	16.94
V-2066	6 x 6"	12	22.93

Adapter fits over the Spigot End of the Sewer Pipe and allows for the transition to DWV pipe.

Coupling DWV Schedule 40

(DWV Hub x DWV Hub)



Part Number	Size	Ctn Qty	List Price
D-104	4"	40	\$5.26

Bushing

(Sewer Spigot x Sewer Hub)



Part Number	Size	Ctn Qty	List Price
V-1143	4 x 3" Flush	25	\$5.27
V-2064	6 x 4" Extended	24	13.63

Adapter fits into Sewer Hub and allows for connection to Sewer Pipe.

Eccentric Bushing

(Sewer Spigot x Sewer Hub)

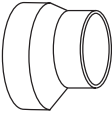

Part Number	Size	Ctn Qty	List Price
V-2164	6x4"	15	\$15.36

Reducer Bushing

(Sewer Spigot x DWV Hub)



Part Number	Size	Ctn Qty	List Price
V-1031	3 x 1 1/2"	25	\$6.47
V-1041	4 x 1 1/2"	25	8.62
V-1042	4 x 2"	25	8.62
V-2031*	3 x 1 1/2"	25	6.47
V-2041*	4 x 1 1/2"	25	8.62

*Threaded

Bushing

(Sewer Spigot x DWV Hub)



Part Number	Size	Ctn Qty	List Price
V-2664	6 x 4" Extended	12	\$17.03

Adapter fits into Sewer Hub and allows for transition to DWV Pipe.

Bushing DWV Adapter Sleeve

(DWV Spigot x Sewer Hub)

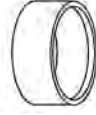

Part Number	Size	Ctn Qty	List Price
V-3033	3 x 3"	25	\$5.38
V-3044	4 x 4"	25	5.38
V-3066	6 x 6"	10	21.35

Adapter fits inside a DWV fitting Hub and allows for transition to Sewer Pipe.

90° 1/4 Bend Long Turn

(Sewer Hub x Sewer Hub)

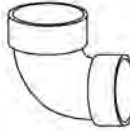

Part Number	Size	Ctn Qty	List Price
V-303	3"	25	\$4.53
V-304	4"	36	4.80
V-366	6"	8	27.73

90° 1/4 Bend Short Turn

(Sewer Hub x Sewer Hub)

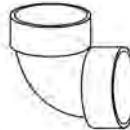

Part Number	Size	Ctn Qty	List Price
V-3303	3"	25	\$3.64
V-3304	4"	25	4.58
V-306	6"	12	15.56

90° 1/4 Bend Street Ell Long Turn

(Sewer Hub x Sewer Spigot)

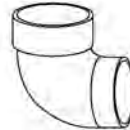

Part Number	Size	Ctn Qty	List Price
V-403	3"	25	\$5.26
V-404	4"	36	5.93
V-466	6"	8	51.65

90° 1/4 Bend Street Ell Short Turn

(Sewer Hub x Sewer Spigot)



Part Number	Size	Ctn Qty	List Price
V-3403	3"	25	\$5.74
V-3404	4"	25	6.12
V-406	6"	12	22.95

45° 1/8 Bend

(Sewer Hub x Sewer Hub)



Part Number	Size	Ctn Qty	List Price
V-503	3"	30	\$3.10
V-504	4"	60	3.23
V-506	6"	18	15.80

45° 1/8 Bend Street Ell

(Sewer Hub x Sewer Spigot)



Part Number	Size	Ctn Qty	List Price
V-603	3"	30	\$3.64
V-604	4"	60	3.76
V-606	6"	18	17.52

22-1/2° 1/16 Bend

(Sewer Hub x Sewer Hub)



Part Number	Size	Ctn Qty	List Price
V-703	3"	25	\$4.31
V-704	4"	30	4.80
V-706	6"	20	17.23

22-1/2° 1/16 Bend Street Ell

(Sewer Hub x Sewer Spigot)



Part Number	Size	Ctn Qty	List Price
V-713	3"	25	\$4.80
V-714	4"	30	5.08
V-716	6"	20	19.15

PVC Sewer & Drain Fittings

White Solvent Weld SDR 35

Conforms to ASTM D3034 Effective March 4, 2013

Tee

(Sewer Hub x Sewer Hub x Sewer Hub)

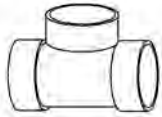

Part Number	Size	Ctn Qty	List Price
V-803	3"	30	\$4.10
V-804	4"	30	5.46
V-806	6"	8	22.95
V-8064	6 x 4"	8	21.05

Cleanout Tee

(Sewer Hub x Sewer Hub x FIP)

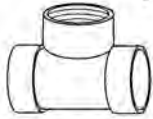

Part Number	Size	Ctn Qty	List Price
V-8804	4"	30	\$13.41

45° Wye

(Sewer Hub x Sewer Hub x Sewer Hub)

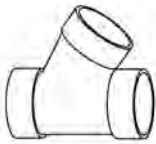

Part Number	Size	Ctn Qty	List Price
V-903	3"	25	\$6.62
V-904	4"	24	7.96
V-906	6"	6	32.53
V-9064	6 x 4"	8	26.78

Sanitary Tee

(Sewer Hub x Sewer Hub x Sewer Hub)

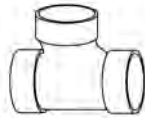

Part Number	Size	Ctn Qty	List Price
V-1103	3"	24	\$5.55
V-1104	4"	25	7.58
V-1106	6"	6	47.83

Saddle Tee

(DWV Hub x S&D Pipe)



Part Number	Size	Ctn Qty	List Price
V-1204	1 1/2 x 4"	25	\$9.56

Cross

(Sewer Hub x Sewer Hub x Sewer Hub x Sewer Hub)



Part Number	Size	Ctn Qty	List Price
V-1304	4"	24	\$14.85

Cap

(Sewer Hub)



Part Number	Size	Ctn Qty	List Price
V-1403	3"	30	\$1.94
V-1404	4"	30	2.22
V-1406	6"	30	9.08

Fits over the Spigot end of Sewer Pipe.

Clay Adapter

(Sewer Hub x Clay Spigot)



Part Number	Size	Ctn Qty	List Price
V-1504	4"	24	\$13.41

Cast Iron Adapter

(Sewer Hub x CI Spigot)



Part Number	Size	Ctn Qty	List Price
V-1604	4"	24	\$13.41

Downspout Adapter

(Downspout x Sewer Hub)

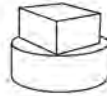

Part Number	Size	Ctn Qty	List Price
V-1703	2 x 3 x 3"	50	\$4.58
V-1704	2 x 3 x 4"	50	4.31
V-1705	3 x 4 x 4"	25	4.88

The first two sizes are the dimensions of the Downspout Square, the third size refers to the Sewer Pipe.

Offset Flush-Fit Downspout Adapter

(Downspout x Sewer Hub)

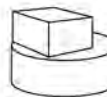

Part Number	Size	Ctn Qty	List Price
V-1714	2 x 3 x 4"	25	\$4.31
V-1715	3 x 4 x 4"	25	6.06
V-1706	4 x 6 x 6"	15	24.86

Drain Grate



Part Number	Size	Ctn Qty	List Price
V-1803	3"	50	\$2.69
V-1804	4"	40	3.36
V-1806	6"	30	14.85

Drops into the Hub end of Sewer Pipe or Fitting.

Fitting Cleanout

(Sewer Spigot x FIP)



Part Number	Size	Ctn Qty	List Price
V-1903	3"	40	\$4.31
V-1904	4"	20	4.31
V-1906	6"	12	21.05

Plug

(IPS Thread)



Part Number	Size	Ctn Qty	List Price
V-2003	3"	50	\$2.59
V-2004	4"	50	2.69
V-2006	6"	12	13.31

Female Adapter

(Sewer Hub x FIP)

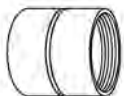

Part Number	Size	Ctn Qty	List Price
V-2103	3"	24	\$5.74
V-2104	4"	24	5.57
V-2106	6"	12	20.98

Two-Way Cleanout

(Sewer Hub x Sewer Hub x Sewer Hub)

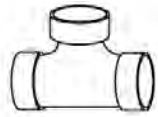

Part Number	Size	Ctn Qty	List Price
V-2204	4"	10	\$15.62

(Sewer Hub x DWV Hub x Sewer Hub)

V-2214	4"	10	\$28.23
--------	----	----	---------

Corrugated Adapter

(Sewer Spigot x Corrugated Insert)



Part Number	Size	Ctn Qty	List Price
A-43*	4 x 3"	60	\$5.04
V-44	4 x 4"	60	5.04

*Styrene Parts.

PVC Sewer & Drain Fittings

White Solvent Weld SDR 35

Conforms to ASTM D3034

Fittings Socket Dimensions - Inches

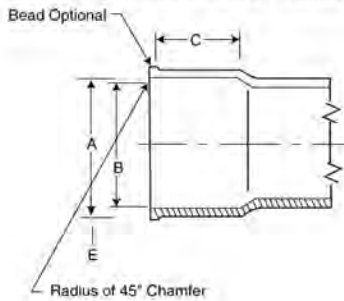

Nominal Size In.	A	B	C
4	4.235 ± 0.009	4.210 ± 0.009	1.75
6	6.305 ± 0.011	5.270 ± 0.011	3.000

Pipe Dimensions

Nominal Size	Outside Diameter		Minimum Wall Thickness
	Average	Tolerance On Average	SDR 35
4	4.215	± 0.009	0.120
6	6.275	± 0.011	0.180

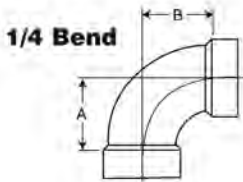

Part No.	Size	Description	A	B
V-304	4"	HXH	3 11/16	3 11/16
V-366	6"	HXH	5 2/16	5 2/16

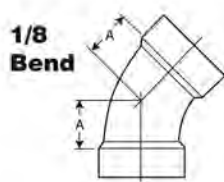

Part No.	Size	Description	A
V-504	4"	HXH	7/16
V-506	6"	HXH	1 3/16

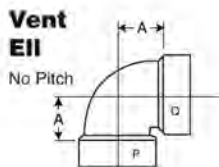

Part No.	Size	Description	A
V-3304	4"	HXH	2 5/32
V-306	6"	HXH	3 3/16

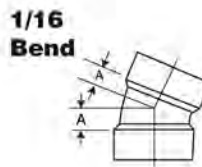

Part No.	Size	Description	A
V-704	4"	HXH	7/8
V-706	6"	HXH	1 3/8

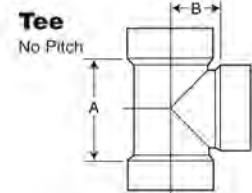

Part No.	Size	Description	A	B
V-804	4"	HXHXH	4 5/16	2 3/32
V-806	6"	HXHXH	6 5/8	3 3/16

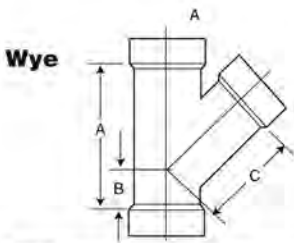

Part No.	Size	Description	A	B	C
V-904	4"	HXHXH	6	5 1/8	5
V-906	6"	HXHXH	1 5/16	7 11/16	7 1/2

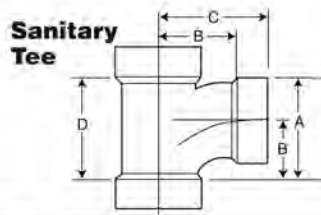

Part No.	Size	Description	A	B	C	D
V-1104	4"	HXHXH	5 7/16	3 11/16	5 7/16	7 3/16
V-1106	6"	HXHXH	9	5 2/16	8 1/25	8 1/2

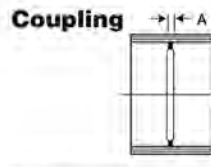

Part No.	Size	Description	A
V-104	4"	HXH	1/8
V-106	6"	HXH	3/16

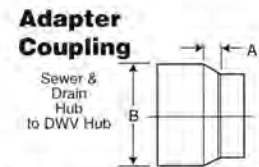

Part No.	Size	Description	A	B
V-2043	4x3	HXH	2 5/32	4.215
V-2044	4x4	HXH	1/4	4.215

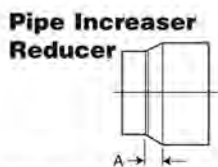

Part No.	Size	Description	A
V-1043	4x3	HXH	1/4
V-1064	6x4	HXH	3/16

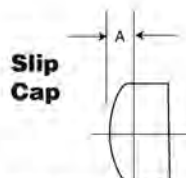

Part No.	Size	Description	A
V-1404	4"	CAP	9/64
V-1406	6"	CAP	21/64

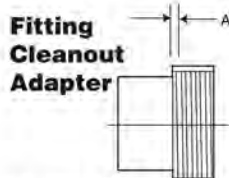

Part No.	Size	Description	A
V-1904	4"	SPGXFPT	1/8
V-1906	6"	SPOXFPT	7/32

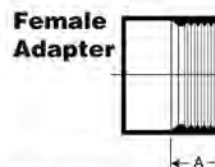

Part No.	Size	Description	A
V-2104	4	HXFPT	1 5/8
V-2104	6	HXFPT	2 1/32

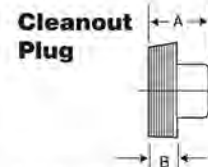

Part No.	Size	Description	A	B
V-2004	4"	MPT	1 1/8	7/8
V-2006	4"	MPT	2	1

To order, call 1-800-322-9463 or Fax 1-800-910-0134 • Prices subject to change without notice.



324 Delaware Avenue • PO Box 446 • Oakmont PA 15139
 www.normandyproducts.com • normandy@normandyproducts.com