

Sample Holder

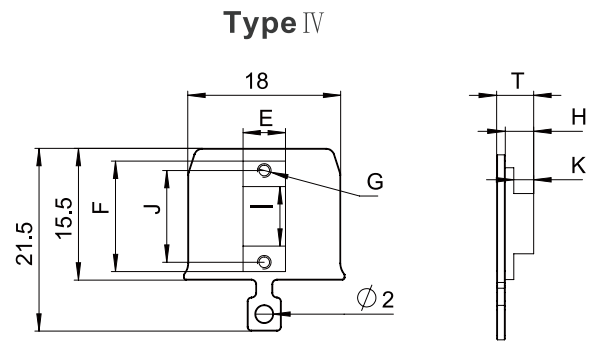

Specification

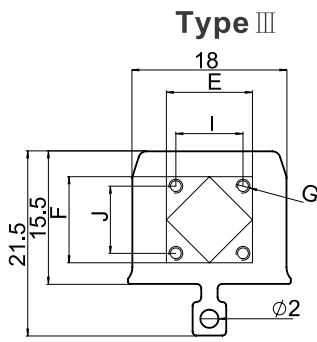
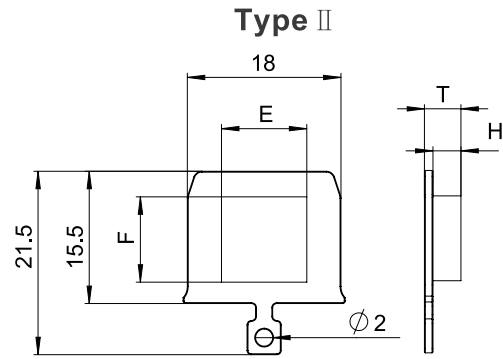
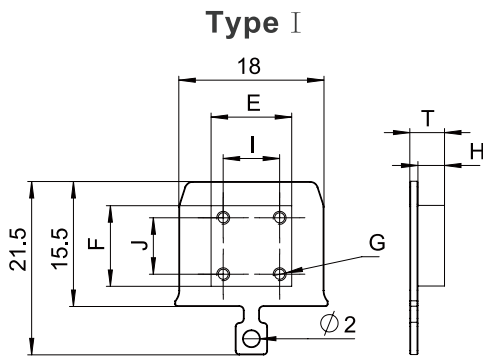

Type	T	E	F	G	H	I	J	K	Material	Part Number
	mm									
I	4.2	10	10	M1.6	3.3	7	7	/	Cu Ta Mo	SH104
II	4.3	10	10	/	3.3	/	/	/		SH107
III	4.3	3	3	M1.6	3.3	7.8	7.8	2.3		SH108
	4.3	5	5	M1.6	3.3	7.8	7.8	2.3		SH103
	4.3	10	10	M1.6	3.3	7.8	7.8	2.3		SH105
IV	4.3	5	13	M1.6	3.3	7	10.8	2.3		SH106

Sample Holder



Specification

Type V

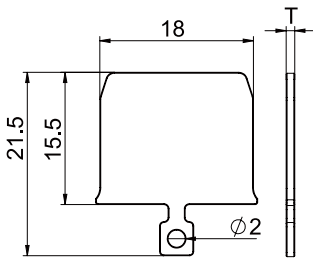

Type VI

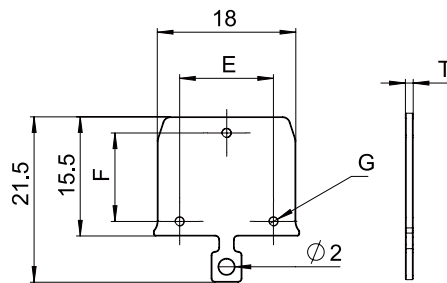

Type VII

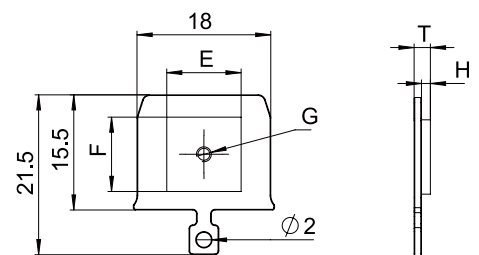

Type	T	E	F	G	H	I	J	K	Material	Part Number
	mm									
V	1	/				/			Ta Mo Inconel	SH101
VI	1	12.2	11.5	M1.4		/				SH102
VII	2.2	10	10	M2	1.2		/		OFC	SH201A