

## Super Complete

Canadian Suggested Retail Price List in USD  
Oct-18

**Mini, Small, Medium, Large**

Phone: 260-665-2769

Fax: 260-665-3047

Email: [iim@mobility-usa.com](mailto:iim@mobility-usa.com)

[www.mobility-usa.com](http://www.mobility-usa.com)

Quote: \_\_\_\_\_

P.O. \_\_\_\_\_

### Bill To

Dealer: \_\_\_\_\_ Contact: \_\_\_\_\_

Address: \_\_\_\_\_

City: \_\_\_\_\_ State: \_\_\_\_\_ Zip: \_\_\_\_\_

Phone: \_\_\_\_\_ Fax: \_\_\_\_\_

Email: \_\_\_\_\_ Mark For: \_\_\_\_\_

### Ship To

Same as Bill To \_\_\_\_\_

Dealer: \_\_\_\_\_ Contact: \_\_\_\_\_

Address: \_\_\_\_\_

City: \_\_\_\_\_ State: \_\_\_\_\_ Zip: \_\_\_\_\_

Phone: \_\_\_\_\_ Fax: \_\_\_\_\_

Email: \_\_\_\_\_ Mark For: \_\_\_\_\_

### Grillo Features and Specifications Mini, Small, Medium, Large

- **Quick Adjustment** - Grillo adjusts easily and tool-free for user growth, transportation, or multiple patient use.
- **Easy Transport** - In just one motion, Grillo folds into a small compact unit easy to transport. No tools required.
- **Exclusively-Designed Wheels** - Grillo wheels come standard with anti-rollback, independently adjustable tension drag, and brakes. The wheels are suitable for indoor and outdoor use.
- **Chest & Pelvic Supports** - Padded and adjustable in angle, height, inclination, and circumference. The chest and pelvic supports work independently.
- **Ergonomic Harness** - The harness supports the user if necessary without generating pressure and is breathable, adjustable, and removable.
- **Measurement Bars** - allow for quick, easy, and accurate adjustment.
- **Grillo** - has the widest range of height adjustment on the market.



### Grillo Frame Options

Part Number	Description	Price (USD)
	<b>Posterior SC</b> - includes frame, pelvic support, ergonomic harness, chest support, horizontal bars, hand grips, directional locks	
_____ GRP	<b>Super Complete Grillo Mini</b>	\$3,400.00
_____ GRP-1/2	<b>Super Complete Grillo Small</b>	\$3,500.00
_____ GRP-3/4	<b>Super Complete Grillo Medium</b>	\$3,800.00
_____ GRP-5	<b>Super Complete Grillo Large</b>	\$4,300.00
	<b>Anterior SC</b> - includes frame, pelvic support, ergonomic harness, chest support, horizontal bars, multi axis hardware, handle bar, directional locks	
_____ GRA	<b>Super Complete Grillo Mini</b>	\$3,500.00
_____ GRA-1/2	<b>Super Complete Grillo Small</b>	\$3,625.00
_____ GRA-3/4	<b>Super Complete Grillo Medium</b>	\$3,950.00
_____ GRA-5	<b>Super Complete Grillo Large</b>	\$4,475.00

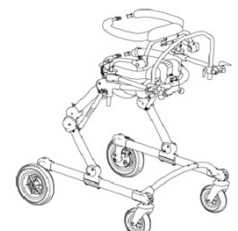
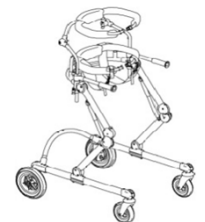

## Handle Options

Part Number	Description	Price (USD)
_____ GR927	<b>Posterior Hand Grips Mn</b> requires GR835	\$50.00
_____ GR927-1/2	<b>Posterior Hand Grips Sm, Md, Lg</b> requires GR835-1, GR835-3	\$50.00
_____ GR926	<b>Anterior Handlebar Mn</b> requires GRI-HW, GR835	\$100.00
_____ GRI845-1	<b>Anterior Handle Bar Sm</b> requires GRI-HW-1, GR835-1	\$100.00
_____ GRI845-3	<b>Anterior Handle Bar Md</b> requires GRI-HW-1, GR835-3	\$125.00
_____ GRI845-5	<b>Anterior Handle Bar Lg</b> requires GRI-HW-1, GR835-3	\$150.00
_____ GRI939	<b>Ergonomic Handles Mn, Sm, Md, Lg</b> requires GRI-HW, GR835	\$125.00
_____ GRI-HW	<b>Multi Axis Hardware Mn</b>	\$75.00
_____ GRI-HW-1	<b>Multi Axis Hardware Sm, Md, Lg</b>	\$75.00

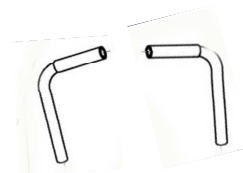
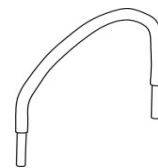
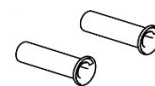

## Arm Support Options

Part Number	Description	Price (USD)
_____ GR809	<b>Arm Supports Mn</b> 7" long 4" wide requires GRI-HW, GR835	\$550.00
_____ GRI809-1	<b>Arm Supports Sm</b> 6" long 4" wide requires GRI-HW-1, GR835-1	\$600.00
_____ GRI809-3	<b>Arm Supports Md</b> 7.5" long 4.5" wide requires GRI-HW-1, GR835-3	\$650.00
_____ GRI809-5	<b>Arm Supports Lg</b> 8" long 5" wide requires GRI-HW-1, GR835-5	\$700.00
<u>Description:</u> Works with Anterior and Posterior. Adjustable in height, direction, depth, tilt, and inclination.		
_____ 943	<b>Arm Straps Mn, Sm (pair)</b>	\$40.00
_____ 943-3	<b>Arm Straps Md, Lg (pair)</b>	\$40.00
_____ 32707	<b>Elbow Stop Sm, Md, Lg</b> 4"x3" padded elbow stop (pair)	\$385.00
_____ 50048	<b>Elbow Stop Cover with Gel Insert (pair)</b> requires 32707	\$250.00

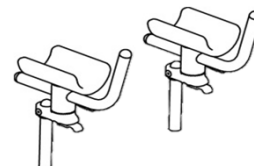
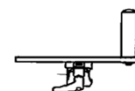

## Accessories

Part Number	Description	Price (USD)
_____ GRI865	<b>Headrest Sm, Md, Lg</b> POSTERIOR ONLY 10" height adjustment Requires Chest Support	\$550.00
_____ GR890-0	<b>Padded Leg Divider Mn</b> 22" long	\$350.00
_____ GRI890-1	<b>Leg Divider Sm</b> 21" long, cuff size 10" - 16"	\$650.00
_____ GRI890-3	<b>Leg Divider Md</b> 23" long, cuff size 14" - 20"	\$700.00
_____ GRI890-5	<b>Leg Divider Lg</b> 28" long, cuff size 18" - 26"	\$750.00

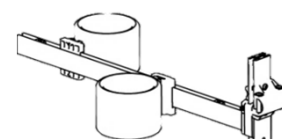
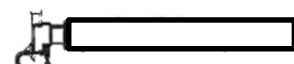

Description: Adjustable in height and stride length.

## Accessories

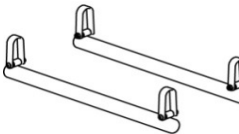
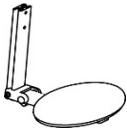
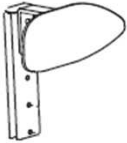
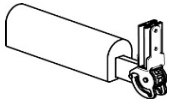
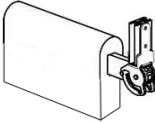
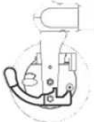
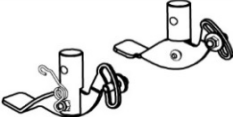
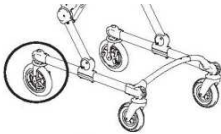
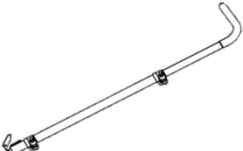
Part Number	Description	Price (USD)	
_____ GR1810-1	<b>Weight Bars</b> Sm 11.5 lbs. total	\$275.00	
_____ GR1810-3	<b>Weight Bars</b> Md, Lg 15 lbs. total	\$295.00	
_____ GR918-1	<b>Folding Seat</b> Sm POSTERIOR ONLY 10" deep, 6" wide	\$335.00	
_____ GR918-3	<b>Folding Seat</b> Md POSTERIOR ONLY 11" deep, 7" wide	\$365.00	
_____ GR1919-1	<b>Lumbar Support</b> Sm POSTERIOR ONLY 3" tall, 8" wide	\$280.00	
_____ GR1919-3	<b>Lumbar Support</b> Md POSTERIOR ONLY 4" tall, 9.5" wide	\$280.00	
_____ GR815-1	<b>Abduction Saddle</b> Sm pad W: 2.5" H: 3.5" L: 9.5" Overall L: 14"	\$345.00	
_____ GR815-3	<b>Abduction Saddle</b> Md pad W: 3" H: 3.5" L: 9.5" Overall L: 14"	\$365.00	
_____ GR815-5	<b>Abduction Saddle</b> Lg pad W: 3" H: 4" L: 14" Overall L: 19" distance between pelvic harness and saddle top hole 4.5" bottom hole 6"	\$445.00	
_____ 34429	<b>Saddle Extension</b> Sm 6" of extended abduction requires GR815-1	\$175.00	
_____ 34430	<b>Saddle Extension</b> Md 6" of extended abduction requires GR815-3	\$185.00	
_____ 34431	<b>Saddle Extension</b> Lg 6" of extended abduction requires GR815-5	\$195.00	
_____ GR929-0	<b>Pedal Parking Brakes</b> Mn Comes attached to wheel	\$275.00	
_____ GR929	<b>Pedal Parking Brakes</b> Sm, Md, Lg	\$275.00	
_____ GR928-3/4	<b>Narrow Rear Wheels</b> Md with pedal brakes In-line wheel makes the overall width 27" instead of 30"	\$675.00	
_____ GR928-5	<b>Narrow Rear Wheels</b> Lg with pedal brakes In-line wheel makes the overall width 28.5" instead of 31.5" for Lg	\$675.00	
_____ GR923	<b>Assistant Push Handle</b> Mn, Sm, Md, Lg	\$290.00	

**Client Measurements**

A Back height: \_\_\_\_\_ F Lower leg length: \_\_\_\_\_  
 B Chest depth: \_\_\_\_\_ G Head height: \_\_\_\_\_  
 C Chest width: \_\_\_\_\_ H Arm height: \_\_\_\_\_  
 D Seat depth: \_\_\_\_\_ Age: \_\_\_\_\_  
 E Seat width: \_\_\_\_\_ Weight: \_\_\_\_\_

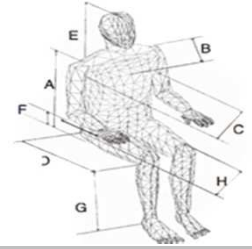

**Dimensions**

**Measurements in Inches**

Grillo	Mini	Small	Medium	Large
Max Capacity	77 lbs	99 lbs	198 lbs	242 lbs
User Height	29 - 39	35 - 53	43 - 65	59 - 75
Unit Weight	28 lbs	36 lbs	43 lbs	51 lbs
<b>A</b>	21 - 31	23.5 - 34	29 - 47	33 - 55
<b>B</b>	20 - 29.5	27 - 39	30 - 49	32 - 56
<b>C</b>	16.5 - 24	19 - 33	21 - 39	25 - 46
<b>D</b>	29	29.5	36	43.5
<b>E</b>	22.5	25.5	30	31.5

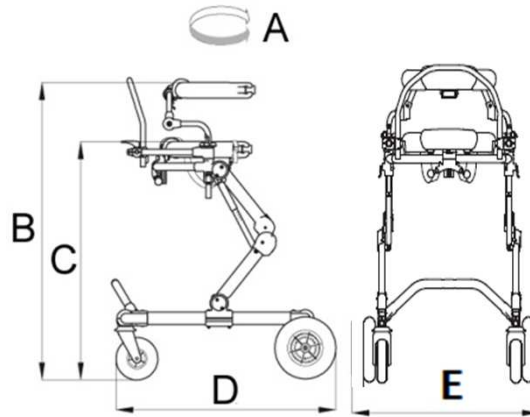

**One Frame → 7 Configurations**

Grillo Small & Medium

Note: All specification and prices are subject to change without notice. Prices listed are only valid if ordering with a gait trainer. The HCPCS codes provided are not intended to be billing or legal advice, rather Innovation In Motion's interpretation of the code definitions. Use of the codes provided does not ensure coverage or payment for the item. For coverage information, verify the policy of the appropriate payer. It is recommended to contact Innovation In Motion with any questions regarding proper ordering of the chair at 1-260-665-2769.