

AVENTURIN





AVENTURIN



TR | Şarküteri, et, balık, hazır yemek ve meze ürünlerinizi aynı hat üzerinde sergileyebileceğiniz Aventurin, statik ve fanlı olmak üzere iki soğutma alternatifleriyle üretilmektedir.

Özellikle taze et ürünleri için tasarlanmış statik soğutma sistemli modelimiz (Aventurin MT), taze etin teşhiri için en ideal koşulunu sağlamakla birlikte, hava sirkülasyonu olmadığı için eti kurutmadan en taze haliyle tüketiciyle buluşturur.

170° açılabilen kademeli amortisörü ile ürün yerleşiminde kolaylık sağlayan Aventurin, dik camları sayesinde yansıma problemlerinin önüne geçerek ürünlerinizin görünürlüğünü ön plana çıkarır.

Aventurin dolabı ön ve yan panelleri için alternatif olarak sunulan ahşap kaplama, boyalı ve paslanmaz metal seçenekleri ile konseptinizle kolayca uyum sağlar.

Paslanmaz ön bar bölümü ile de teşhir alanınızı genişletmenin yanı sıra, müşterileriniz için ergonomik bir kullanım alanı oluşturmaktadır. Sergilenen ürüne bağlı olarak poşetlik, kesme tahtası, bıçaklık gibi özel tasarım aksesuarlar kullanım kolaylığı sağlarken şıklıktan ödün vermemektedir.





AVENTURIN



EN | Aventurine, which enables the display of delicatessen, meat, fish, ready food and appetizers on the very same line, is produced with either static or air-blast cooling system alternatives.

The static cooling system (Aventurin MT) which is specially designed for meat products provides not only the ideal temperature for display but also prevents the meat from running dry -by having no air circulation- and thus allows the product to meet its customers with its freshest state.

With its 170° opening glass and graded damper add-on, Aventurin creates easiness for product placement and eliminates light reflections and thus puts visual quality of your products to the forefront by means of its perpendicular glass.

Aventurin creates harmony with your store's concept with its wood dressing, painted or stainless steel options for the rear and/or side panels.

The stainless front bar panel, while enlarging your display area, creates ergonomic usage for your customers. Product-specific accessories such as nylon bag storage, cutting board and knife box create user-friendliness while enhancing display elegance.



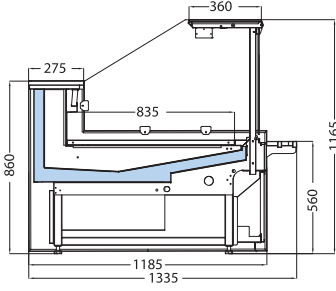

AVANTURIN 2290/DL/1335

Uzunluk mm Length mm	1250 1875 2500 3750
Teşhir Alanı m ² Display Area m ²	1,04 1,56 2,08 3,13
Yan panel Kalınlığı mm End Panel Thickness mm	50

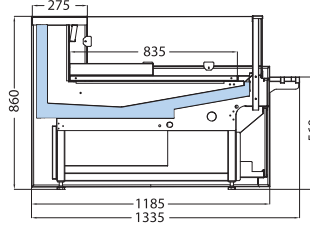

AVANTURIN 2290/DL/SS/1335

Uzunluk mm Length mm	1250 1875 2500 3750
Teşhir Alanı m ² Display Area m ²	1,04 1,56 2,08 3,13
Yan panel Kalınlığı mm End Panel Thickness mm	50

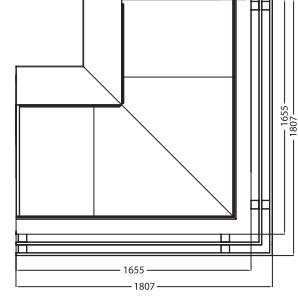
AVANTURIN DL 90°
DIŞ KÖŞE / EXTERNAL CORNER

Uzunluk mm Length mm	90°
Teşhir Alanı m ² Display Area m ²	1.87

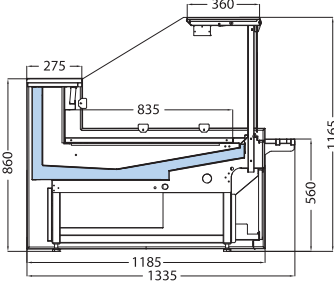

AVANTURIN MT/1335

Uzunluk mm Length mm	1250 1875 2500 3750
Teşhir Alanı m ² Display Area m ²	1,04 1,56 2,08 3,13
Yan panel Kalınlığı mm End Panel Thickness mm	50

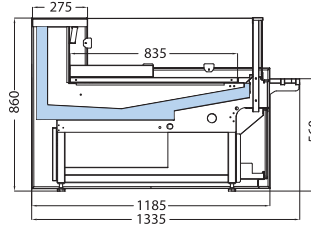

AVANTURIN MT/SS/1335

Uzunluk mm Length mm	1250 1875 2500 3750
Teşhir Alanı m ² Display Area m ²	1,04 1,56 2,08 3,13
Yan panel Kalınlığı mm End Panel Thickness mm	50

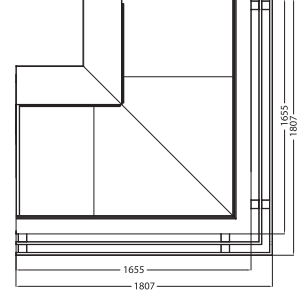
AVANTURIN MT 90°
DIŞ KÖŞE / EXTERNAL CORNER

Uzunluk mm Length mm	90°
Teşhir Alanı m ² Display Area m ²	1.87

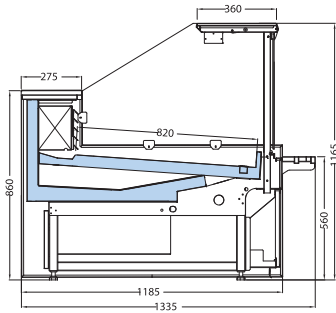

AVANTURIN ST/1335

Uzunluk mm Length mm	1875 2500 3750
Teşhir Alanı m ² Display Area m ²	1,54 2,05 3,07
Yan panel Kalınlığı mm End Panel Thickness mm	50

Aksesuarlar / Accesories



Modül bölücü
Module divider



Kademeli tava
Tiered shelves



Korunmalı askı kancası
Protected hook



Pricoplex ürünler
Pricoplex products



Geri dönüşüm kutusu
Recycling bin



Rulo poşetlik
Roll up paper storage



Poşetlik
Paper storage



Pricoplex ürünler
Pricoplex products



Kesme tahtası
Cutting board



Paslanmaz bar
Stainless steel book bar



Ara bölücü
Module divider



Pricoplex ürünler
Pricoplex products





www.kaplanlar.com

KAPLANLAR SOĞUTMA SAN. ve TİC. A.Ş.
DOSAB Kardelen Sokak No. 18 Bursa / TÜRKİYE
Tlf: +90 224 261 05 73
Fax: +90 224 261 05 79
info@kaplanlar.com

