

**NORMAN**<sup>®</sup>  
SHUTTERS. BLINDS. SHADES.

# Norman<sup>®</sup> Ultra Shutters

Program Reference Guide

2020

Effective Date	Topic	Section	Note
2020/02/20	Frame Styles, Special Options, Specialty Shapes, Ultra Invisible Hinge	e,k,l,i	<p>e: add content: Default principle: Regarding shutter with horizontal T-post type issue: Horizontal T-Post type will always be the Chamfer T post unless otherwise specified.</p> <p>k: 1.Café Shutters add content: When the height of the framing material (including t-posts) exceeds the panel height, by more than 5", a surcharge will apply.</p> <p>2.Custom Colors add a new custom color deck " Benjamin Moore, Off White Collection M2451888TL"</p> <p>l: add contents for Specialties shutter</p> <p>i: add Ultra Invisible Hinge colors images</p>

2019 Shutter Revision log

NORMAN® ULTRA

Effective Date	Topic	Section	Note
2019/01/01	all	All except j,m&o	2019 new added
Middle of January 2019	Motorized	o	2019 new added
2019/01/10	track	j 2	Add 3" louver for Open bypass
2019/02/01	Color	e,i,n,o,p	1. Add 6 new hinge colors. 2. Change color coordination chart. 3. For Motorized 180° Bifold Track Shutter, the header width is no less than 3.75".
2019/02/27	Side magnet	i	Add notes: if panels only with side magnets and there is no standard magnet on the back of panels, panels may open for external factors.
2019/03/01	tracks	j1, j2	2016 stopper Change Note: Bifold track: For 90° Floating Panels outside mount/semi-inside mount without sideboards <del>but with fascia returns</del> , 2016 Stopper will be supplied and the gap between the fascia return / end of top track and the panel is 5mm each side.  Bypass track: 1 · note: Note: For Semi-Inside/OM bypass without side boards <del>but with fascia return</del> , 2016 Stopper will be supplied. 2 · note: For outside mount/semi-inside mount bypass without side boards <del>but with fascia returns</del> , the 2016 Stopper will be supplied by default. The gap between the fascia return / end of top track and the panel is 5mm each side.
2019/03/13	New PerfectTilt RF	O/k	O: Revise Norman Dial (Remote) Dimensions : 68mm diameter x 21mm
2019/03/16	New PerfectTilt RF	O	Add comments of PerfectTilt G4 & groups
2019/04/09	surcharge notes	b,e,g,i,k,l	<a href="#">Change notes from</a> *Surcharge applies. Please see Options and Surcharges page for details <a href="#">to</a> *Some surcharges apply <a href="#">on the bottom of a page</a>
2019/04/27	New PerfectTilt RF	o	<a href="#">Hub note: change "It will be available in March 2019" to "It will be available soon"</a>

2019 Shutter Revision log

NORMAN® ULTRA

2019/04/30	Custom color	k	Update custom color booklet name
2019/05/06	Hardware-pole	i	Pole remove pole length 43"
2019/05/09	Custom T post	e	move Custom T post comment near to T post drawing
2019/07/10	New PerfectTilt RF		Change Micro USB cable usage.
2019/07/15	New PerfectTilt RF		1. Remove the O section, and that motorization is now in a separate program binder; 2. Add Micro USB Cable Length: 3 meters;
2019/07/27	Specialty Shutters	l	add the drawing of Standard unit with horizontal arch center
2019/08/05	Custom T post, S1 and S2 Scribe trim	e	1. Add content for Custom T post: <ul style="list-style-type: none"> <li>▪ Size limits (7 1/2")</li> <li>▪ That a surcharge applies and customers should refer to their shutter pricing</li> <li>▪ Any limitations</li> </ul> 2. Add drawing and description of the S1 and S2 Scribe trim
2019/08/05	Direct Mount 3" Hinge, Pole	i	1. Add drawing and description of Direct Mount 3" Hinge 2. Add notes for Ultra Invisible Hinge: (Not available for Direct Mount) 3. Increase 1 pole length (2pcs combined by connector)
2019/08/14	Specialty Shutters Shutter pole	i, l	1. Rounding new added pole length to 53" (2pcs combined by connector). 2. Add Specialty Shutters drawings
2019/08/26	quarter round scribe trim	e	Add quarter round scribe trim.
2019/08/30	Table of Contents , Colors & Louver Sizes/Louver	b,i,n	1. Revise the table of contents information, rename point b 2. i: Revise "Nickel" hinge color to "Nickel Plated", revise color coordination chart

2019 Shutter Revision log

NORMAN® ULTRA

	Clearance, Hardware,		<p>3. i: Remove shutter pole length 32"</p> <p>4. Remove n section, and that information will be in b&amp;i sections</p>
2019/10/05	<p>Tilt rods;</p> <p>General product specification;</p> <p>Bifold track</p>	f,g,j1	<p>1). Revise Split tilt information</p> <p>2). Add Content: <b>Shutters without bottom supports</b></p> <p>Shutters without bottom supports may sag and deform, including situations below:</p> <ol style="list-style-type: none"> <li>1. Shutters with bottom gap over 0.1";</li> <li>2. Shutters with no frame or no existing sill at the bottom to support the panel (or bottom has frame/existing sill, but the panel keep to open long time without bottom support).</li> </ol> <p>3). Revise track drawing ( correct 1 1/2" louver to 2 1/2")</p>
Middle of October	<p>1.83" sill plate with 3/8" light block,</p> <p>1.83" sill plate with 5/8" light block,</p>	e	<p>Add new 1.83" sill plate with 3/8" light block to replace 1.7" sill plate with 3/8" light block / add new 1.83" sill plate with 5/8" light block to replace 1.7" sill plate with 5/8" light block for 2.5" Mission deco frame at first</p>
2019/10/23	<p>1.83" sill plate with 3/8" light block,</p> <p>1.83" sill plate with 5/8" light block,</p>	e	<p>For 2.5" Mission deco frame: use new 1.83" sill plate with 3/8" light block to replace 1.7" sill plate with 3/8" light block , use new 1.83" sill plate with 5/8" light block to replace 1.7" sill plate with 5/8" light block.</p>
2019/11/01	<p>Panel Lock position,</p> <p>Shutter pole</p>	i	<ol style="list-style-type: none"> <li>1. Panel Lock position: add drawings of L/R/LR panel configuration</li> <li>2. Update New pole lengths (2pcs Combined by Connector): Poles will be with Plastic Tube.</li> </ol>
2019/11/07	Ring Pull	i	<p>Add content:</p> <p><b>Ring pull location principle for Floating Panels:</b></p> <ol style="list-style-type: none"> <li>1. When floating panel config is in pairs, it will be split into halves, the left will be for LL and the right will be for RR. So the ring pull location for FF/FF, FF/FF/FF/FF will be same as that of panel config as LL/RR, LL/LL/RR/RR.</li> </ol>

2019 Shutter Revision log

NORMAN® ULTRA

			<ol style="list-style-type: none"> <li>2. When floating panel config is FF, the ring pull location will be same as that of panel config LL.</li> <li>3. When floating panel config is FFFF/FF, the ring pull location will be same as that of panel config LLLL/RR.</li> <li>4. When floating panel config is singular, it will be split into 3 sections, the left and mid sections are for LL and the right section is for RR. So the ring pull location for FF/FF/FF, FF/FF/FF/FF/FF will be same as that of LL/LL/RR, LL/LL/LL/RR/RR.</li> </ol>
2019/12/01	Custom Colors	k	Revise Custom Colors information
2019/12/06	Specialties	l	Add Content: Please note that Hinge sunburst at Top w/Divider Strip is not available for Ultra program.

Table of Contents	Page
a. Features & Benefits	NU a-1
<b>b. Colors &amp; Louver Sizes/Louver Clearance</b>	NU b-1
c. Stiles	NU c-1
d. Panel Configurations	NU d-1
e. Frame Styles	NU e-1
f. General Product Specifications	NU f-1
g. Tilt Rods	NU g-1
h. Divider Rails	NU h-1
i. Hardware	NU i-1
j. Track Shutters	NU j-1
k. Special Options	NU k-1
l. Specialties	NU l-1
m. Pricing	NU m-1
<b>n. Appendix</b>	<b>NU n-1</b>

Disclaimer: Norman International, Co. reserves all rights on updating or modification of any contents within this documentation without prior notification.

Effective 2020

# NORMAN® ULTRA

## Features and Benefits

- Norman®'s finest wood shutter, featuring Ultra premium graining and consistency
- Made of hand-selected Ultra material that is treated with Prescription Wood Conditioning™ technique according to the moisture content of the final installation location to reduce post-installation shrinking and swelling.
- Louvers are made of quarter-sawn wood to ensure generations of durability. This tight, straight and parallel grain also enriches wood character in stain finish.
- The appearance of furniture quality finish and the exceptional craftsmanship gives Ultra shutters an instant feeling of art.
- Reinforced engineered stile-- Multiple layers of wood bonded together to reinforce durability to the core of the stile, which results in a robust support system for the shutter panel.
- Employs mortise and tenon joinery that resists shear and racking forces endured by shutters to ensure prolonged quality and durability.
- Quick and easy on-site installation with the pre-installed magnets and hinges, as well as pre-mitered frames and slotted keyholes.
- A labor-intensive hand finishing process that involves multiple sanding and coatings with fine layers of stain or paint to achieve a translucent and polished appearance.
- Ultra material is especially great for large window openings.
- Available in a multitude of solid, stain, and custom colors that can match the style of any home.
- 30% more material than Normandy.
- Adjustable Ultra Invisible hinge for modern finish.



## Colors & Louver Sizes/Louver Clearance

No.	Color ID	Color Name	Paint/Stain
1	001	Pure White	Painted
2	002	Extra White	Painted
3	003	Silk White	Painted
4	004	Bright White	Painted
5	006	Pearl	Painted
6	007	Ivory Lace	Painted
7	009	Creamy	Painted
8	012	Crisp Linen	Painted
9	016	Butter	Painted
10	019	String	Painted
11	030	Moondust	Painted
12	032	Sea Mist	Painted
13	042	Hall Gray	Painted
14	046	Ice	Painted
15	048	Chai	Painted
16	049	Stone Gray	Painted
17	051	Brown Gray	Painted
18	053	Clay	Painted
19	063	Decorators White	Painted
20	066	Winchester White 2010	Painted
21	073	Sky Gray	Painted
22	074	Element Gray	Painted
23	075	Storm Gray	Painted
24	077	Dawn	Painted
25	078	Cloud Blue	Painted
26	080	Taupe Gray	Painted
27	836	Classic Black	Painted
28	108	Rustic Gray	Stain
29	109	Weathered Teak	Stain
30	110	Limed White	Stain
31	111	Pebble	Stain
32	200	Natural	Stain
33	202	Golden Oak	Stain
34	205	Goldenrod	Stain
35	212	Dark Teak	Stain
36	215	Cordovan	Stain
37	220	New Ebony	Stain

\*Some surcharges apply

# NORMAN® ULTRA

38	221	Black Walnut	Stain
39	229	Rich Walnut	Stain
40	230	Old Teak	Stain
41	232	Red Mahogany	Stain
42	237	Wenge	Stain
43	242	Auburn	Stain
44	246	Matte Black	Stain
45	248	Pretzel	Stain
46	250	Sumatra	Stain
47	252	Toffee	Stain
48	254	Driftwood	Stain
49	255	Silver Gray	Stain
50	256	Mist	Stain
51	862	French Oak	Stain

Louver	
Elliptical	1 7/8"*
	2 1/2"
	3"
	3 1/2"
	4 1/2"

## Louver Depth Clearance

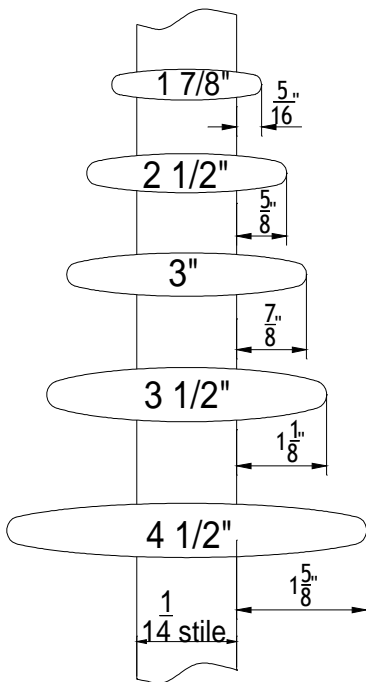

\*Some surcharges apply

# Louver Depth Clearance For Specific Frames

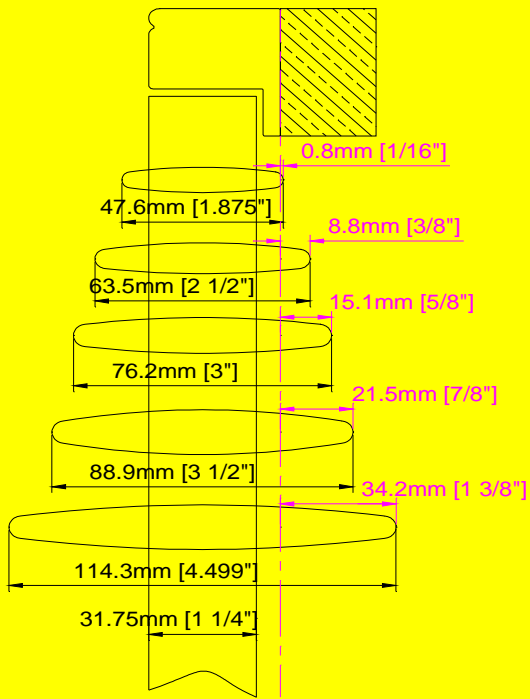

L Frame with 1/4" light block

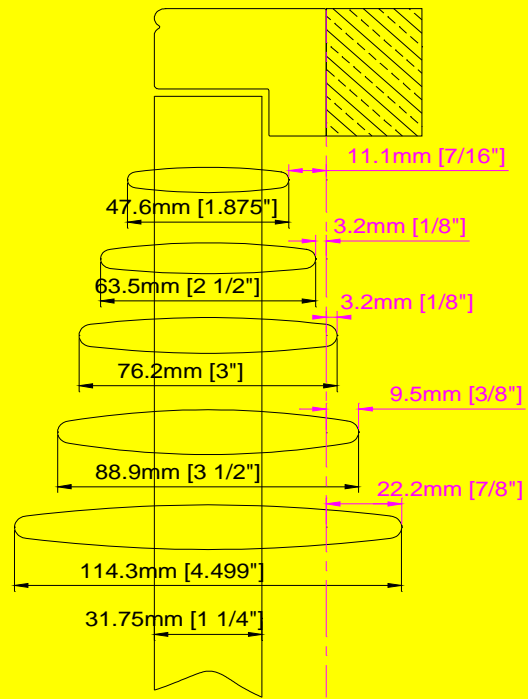

L Frame

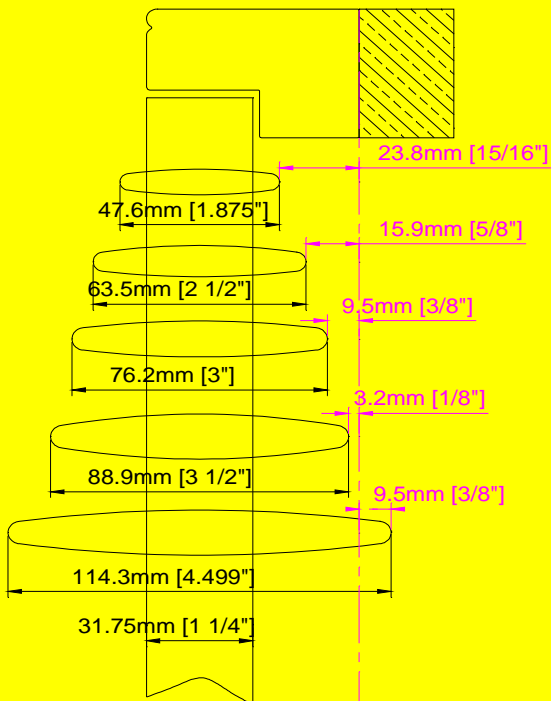

L Frame with 1/2" Buildout

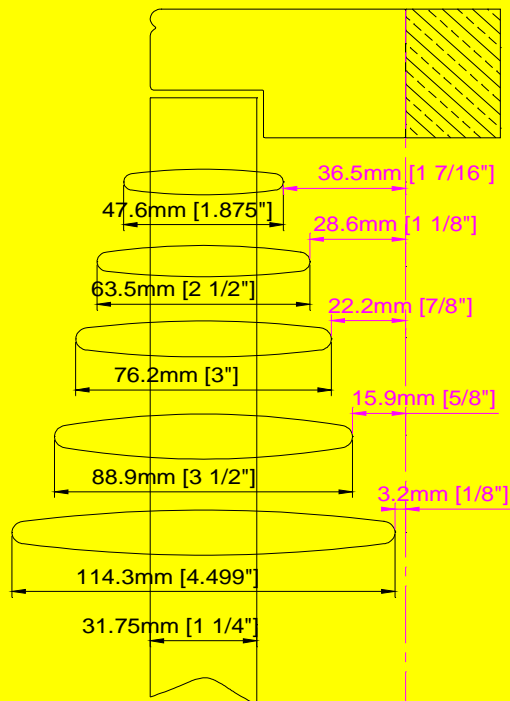

L Frame with 1" Buildout

\*Some surcharges apply

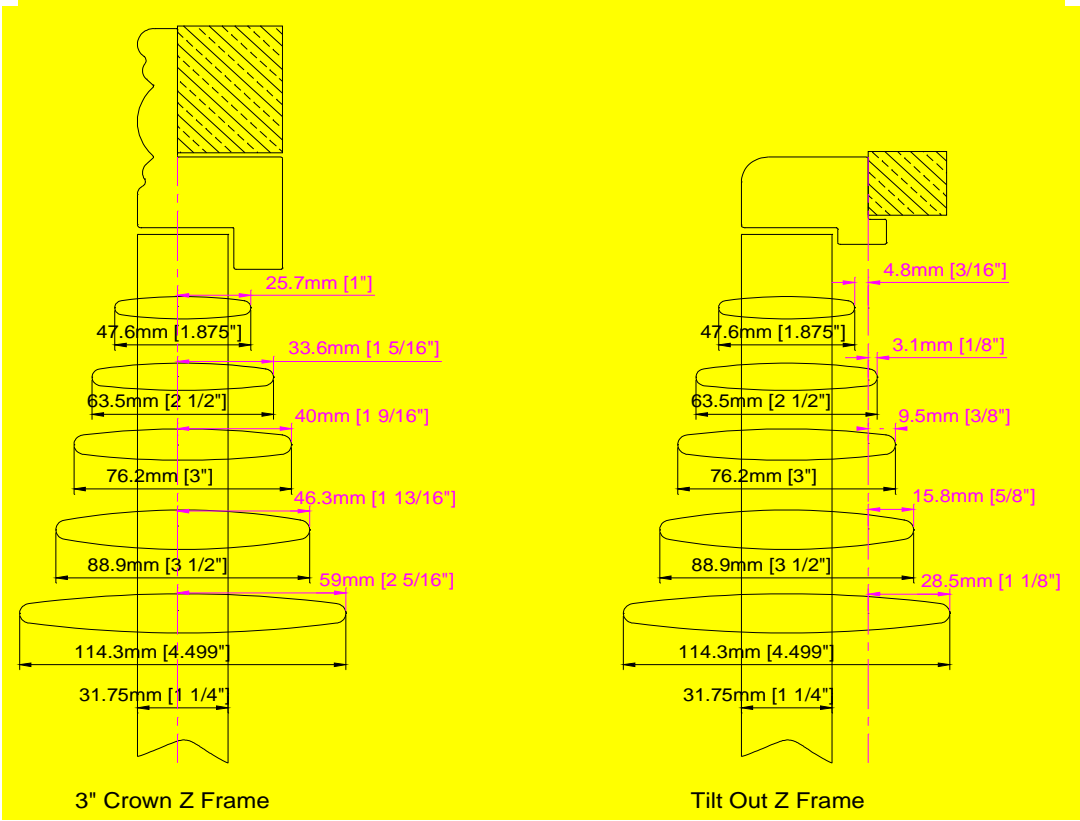
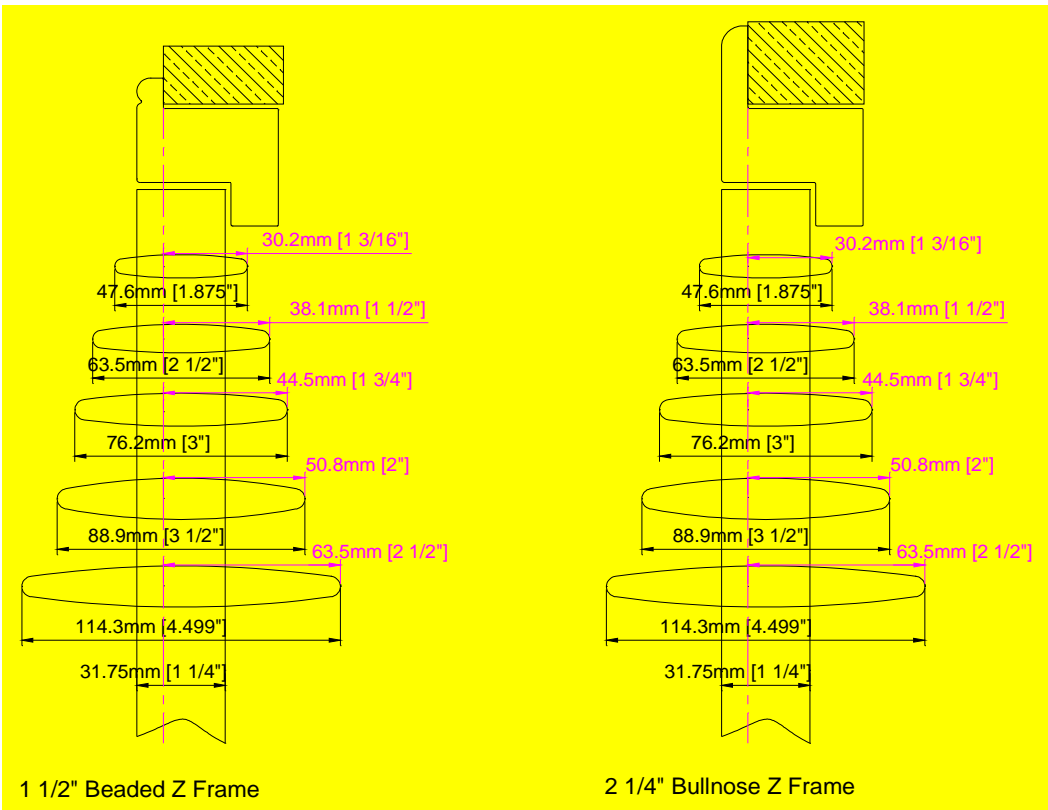

\*Some surcharges apply

# NORMAN® ULTRA

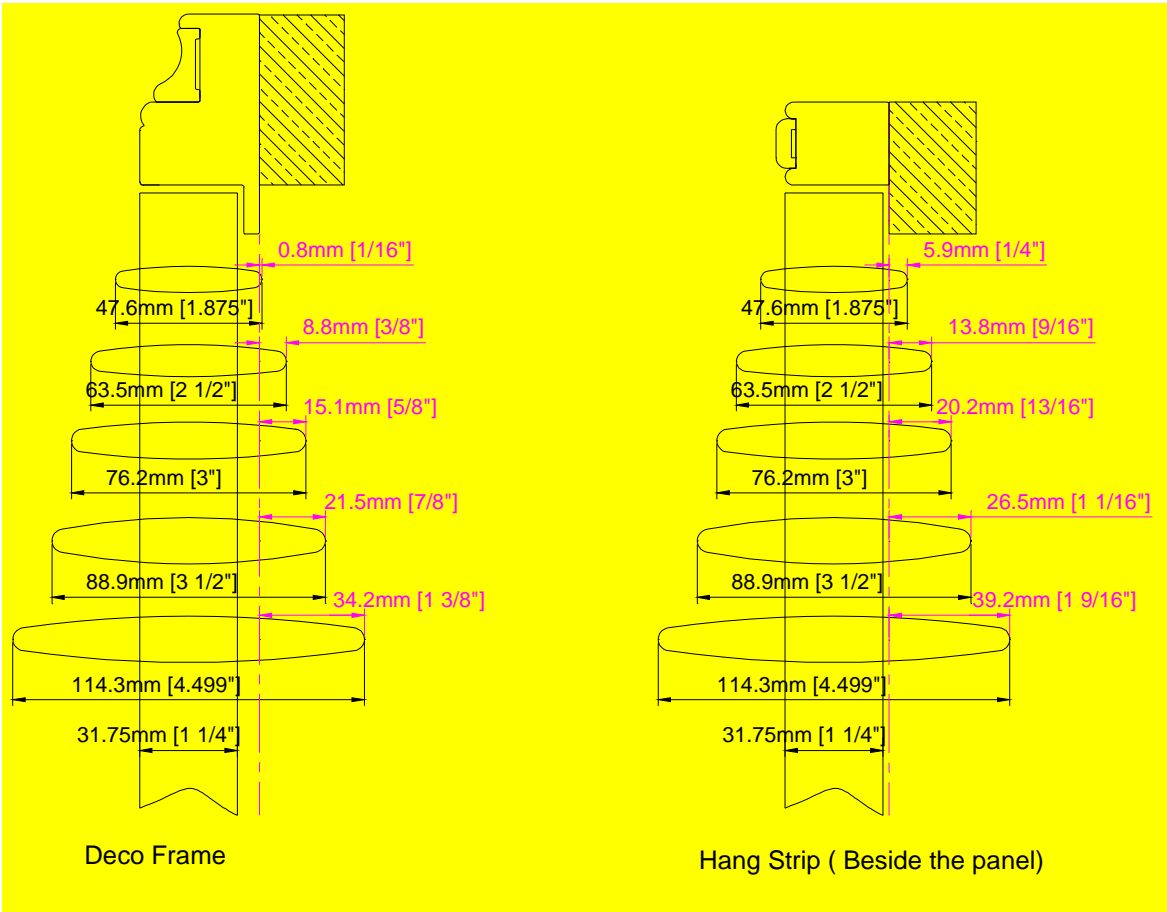

\*Some surcharges apply

NU b-5

**Stiles Options**

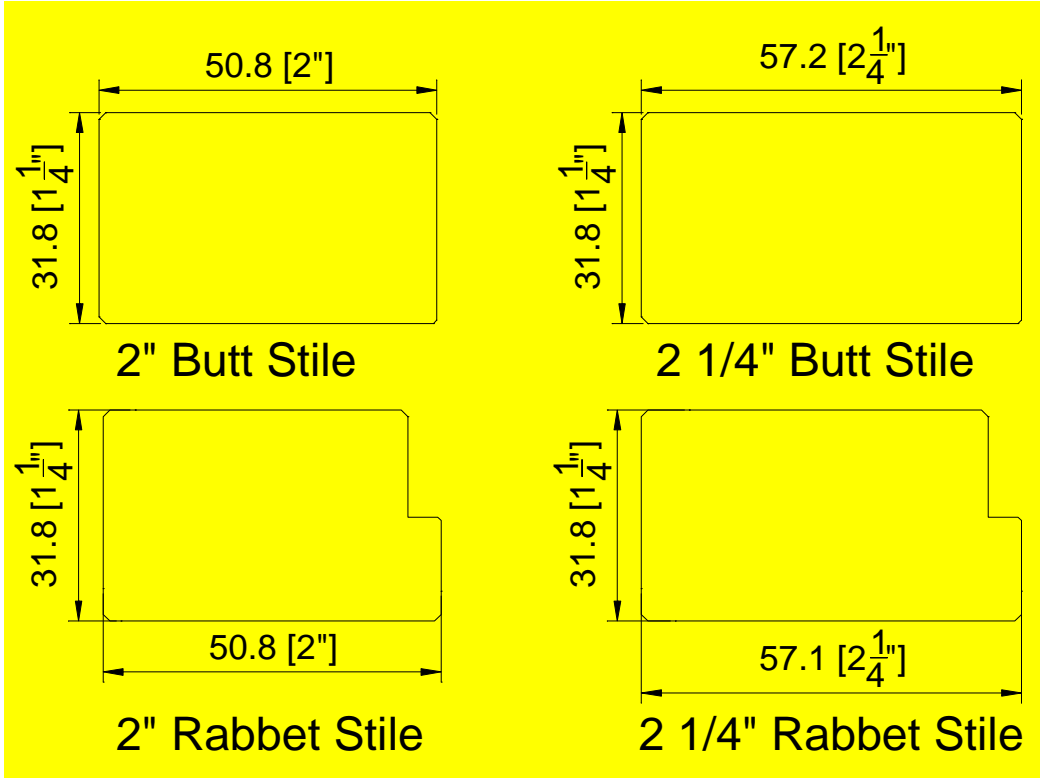

## Stile between panel closure

### Single panel

- I) Panel width < 9"
  - Rabbeted stile (Deco frame, L frame, Z frame and Hang strip beside panel)
    - 2"
    - 2 1/4"
  - Butt stile only (Direct Mount)
    - 2"
    - 2 1/4"
- II) Panel width ≥ 9"
  - Butt stile only
    - 2"
    - 2 1/4"

### 2 panels or more

- Rabbet stile
  - 2"
  - 2 1/4"

# Panel Configurations

## Single Panel

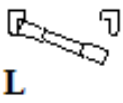

L

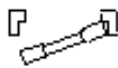

R

OR

## Two Panels

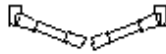

LR



LL



RR

## Three Panels



LLR

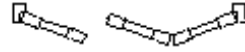

LRR

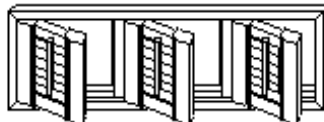

LTLT

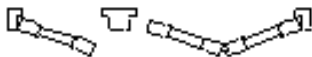
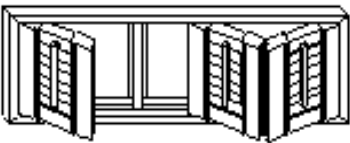

LTRR

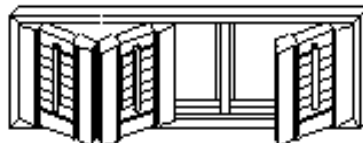

LLTR



# Panel Configurations (continued)

## Four Panels

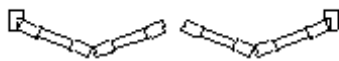

**LLRR**

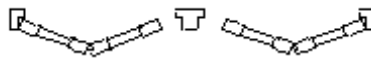
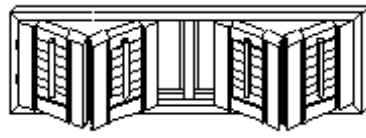

**LLTRR**

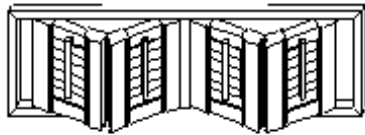

**RRLL**



**LTLRTR**

## Six Panels

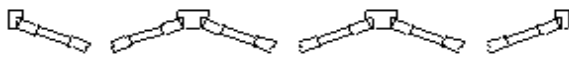

**LRTLRTL**

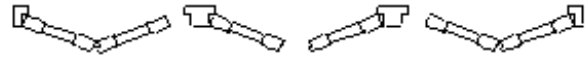

**LLTLRTR**

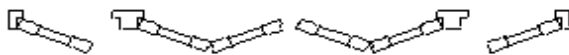
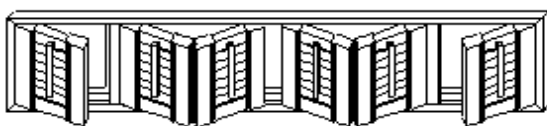

**LTLRRTL**

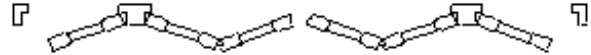
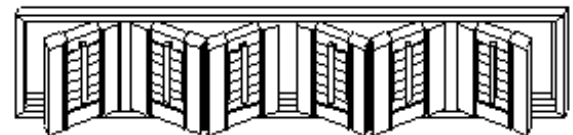

**RTLRLTL**

# Frame Styles

NORMAN® ULTRA

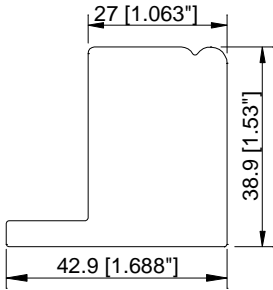

Beaded L Frame  
w/ 1/4" Light Block

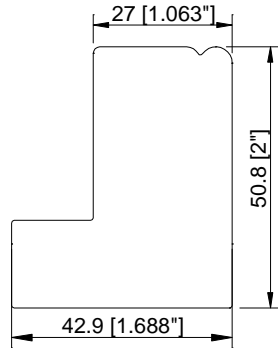

Beaded L Frame

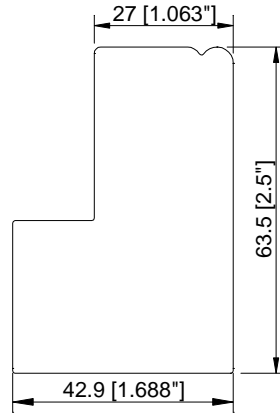

Beaded L Frame  
W/ 1/2" Buildout

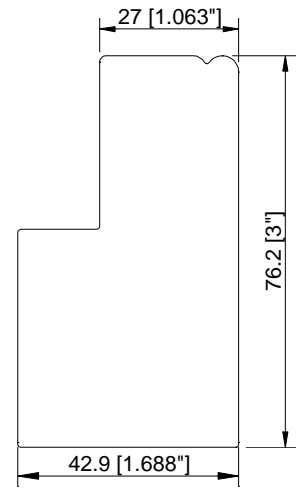

Beaded L Frame  
W/ 1" Buildout

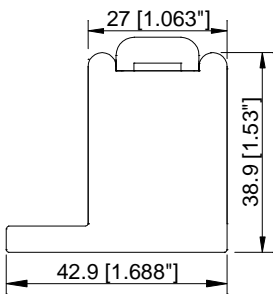

Vintage L Frame  
w/ 1/4" Light Block

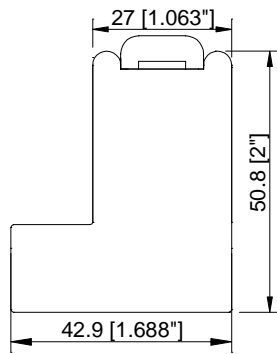

Vintage L Frame

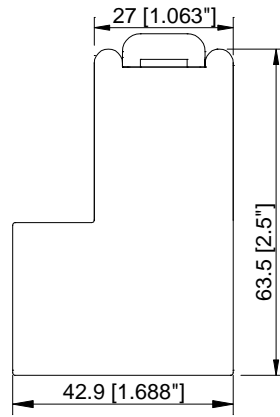

Vintage L Frame  
W/ 1/2" Buildout

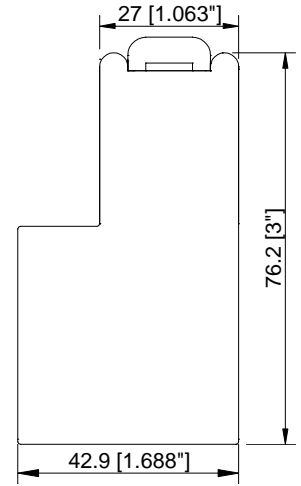

Vintage L Frame  
W/ 1" Buildout

Also available

- Custom extensions\* up to 2" for L frames

\*Some surcharges apply

# Frame Styles

NORMAN® ULTRA

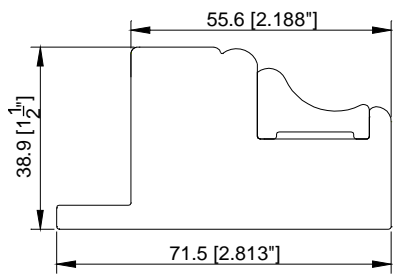

2 3/16" Classic Deco Frame

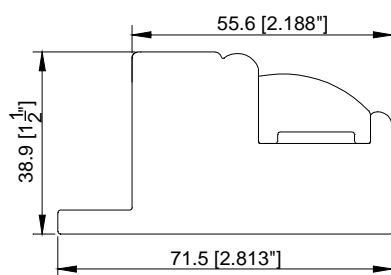

2 3/16" Camber Deco Frame

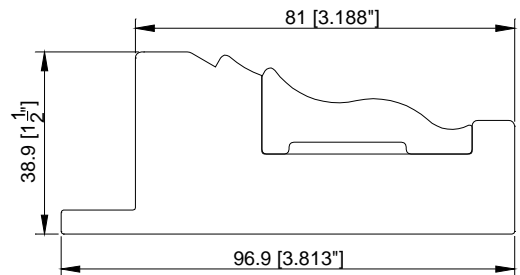

3 3/16" Ridge Deco Frame

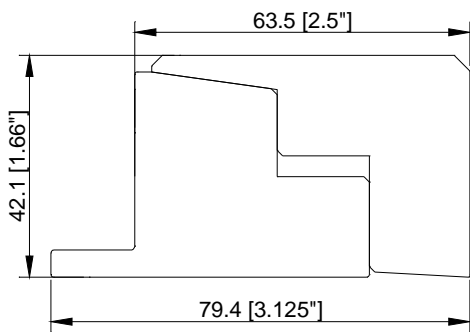

2 1/2" Mission Deco Frame

There are 2 options for the Deco frame installation when Window Size is given (Take Camber Deco frame as an example)

1. Default: light block part install into the window opening;

The window size is the exact size of the window opening;

The MFF size is the measurement of the entire shutter, including the frames;

The MFF size = Window Size + Face Width

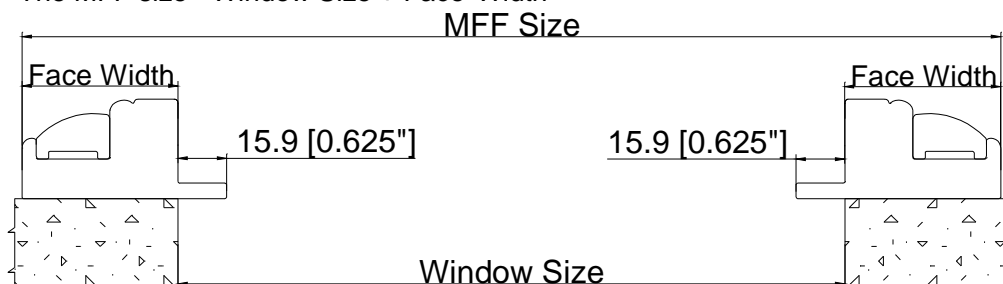

2. Optional: light block part flush with window opening.

# Frame Styles

# NORMAN® ULTRA

The window size is the exact size of the window opening;  
 The MFF size is the measurement of the entire shutter, including the frames;  
 The MFF size = Window Size + Frame Back Width

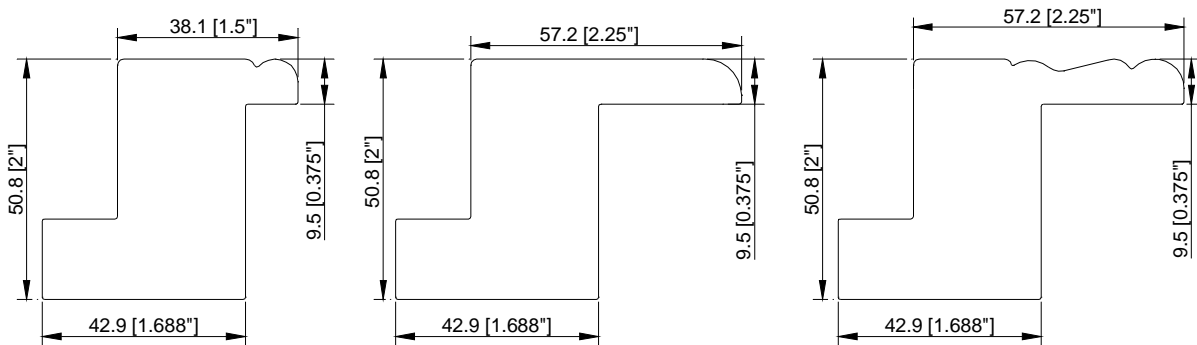
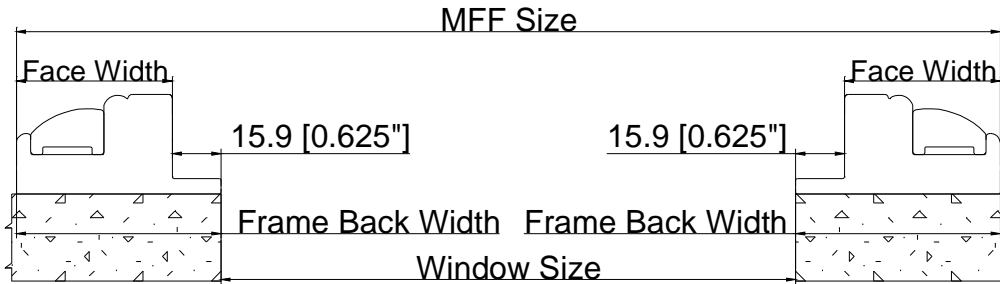

1 1/2" Beaded Z Frame

2 1/4" Bullnose Z Frame

2 1/4" Bel Air Z Frame

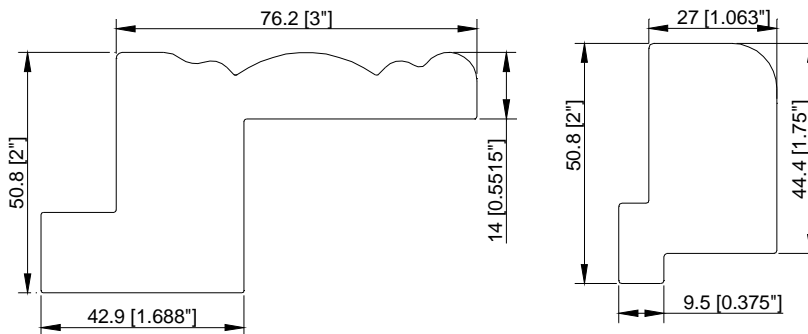

3" Crown Z Frame

Tilt Out Z Frame

Also available

- Custom extensions\* up to 1" for Z frames
- 1/2", 1" and 1 1/2" standard extensions\* and custom extensions\* up to 2" for Deco frames
- Custom extensions\* up to 2" for hang strips (OM)

\*Some surcharges apply

# Frame Styles

NORMAN® ULTRA

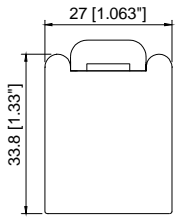

Vintage Hang Strip

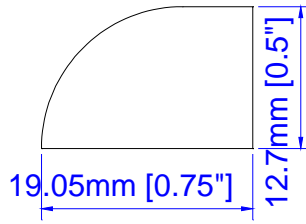

Quarter Round Scribe Trim

Note: Hang Strip is only available for beside panel, not available for behind panel.

## Sill Frames- For use where there is no existing sill

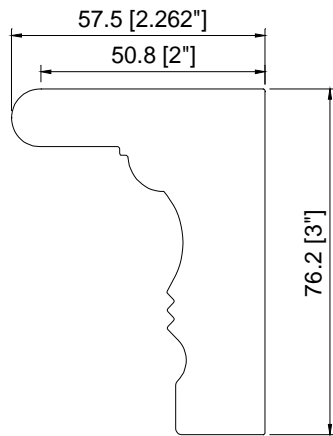

3\"/>

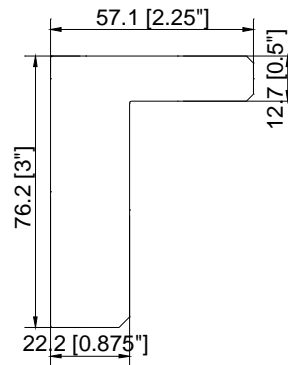

Mission sill Frame

## Sill Caps-Used to cover existing sills

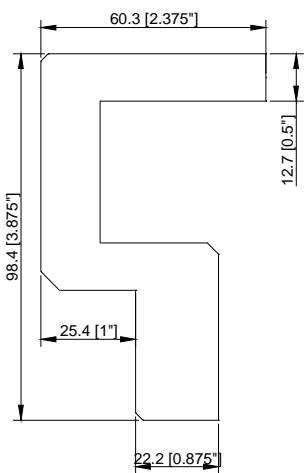

Mission Sill Cap (D/HS)

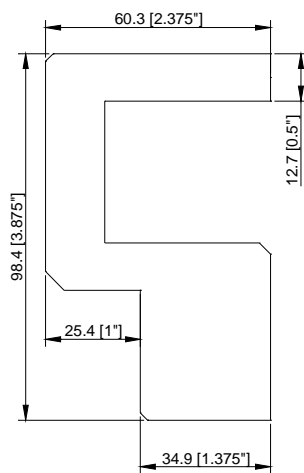

Mission Sill Cap (L)

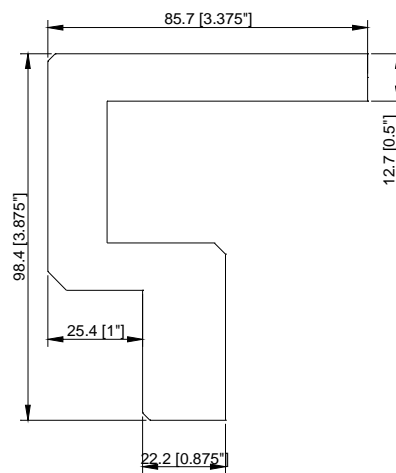

Mission Sill Cap (Z)

Note: For Mission Sill Cap, the extended size at each side needs to be 1\"/>

\*Some surcharges apply

# Frame Styles

NORMAN® ULTRA

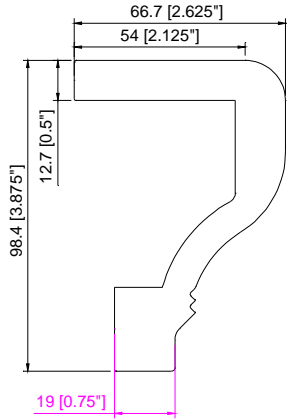

Designer Sill Cap(D/HS)

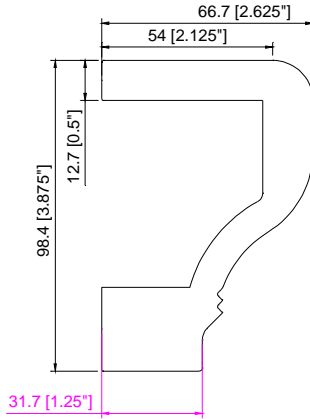

Designer Sill Cap(L)

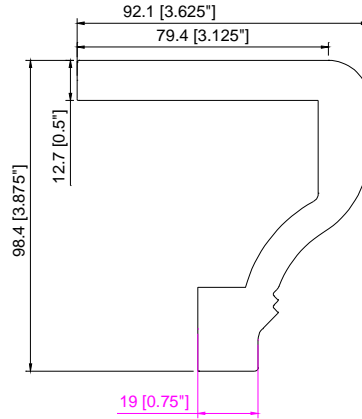

Designer Sill Cap(Z)

## Sill Plates- Used with existing sills

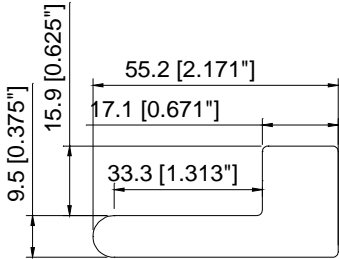

2.17" Sill with 5/8" Light block (L/Z)

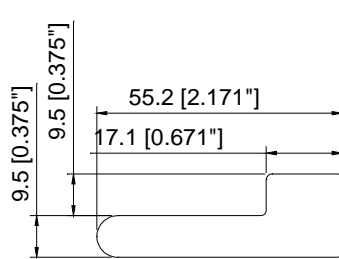

2.17" Sill with 3/8" Light block (L/Z)

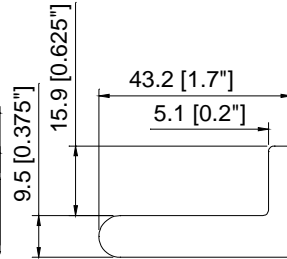

1.7" Sill with 5/8" Light block (Deco)

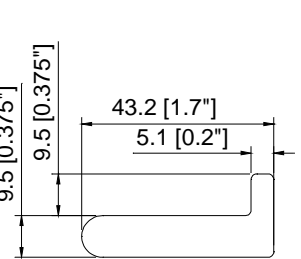

1.7" Sill with 3/8" Light block (Deco)

For non-2 1/2" Mission Deco frame & L frames with 1/4" light block

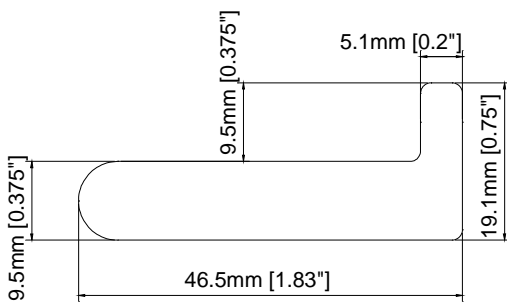

1.83" Sill plate with 3/8" light block  
(For 2.5" Mission Deco frame)

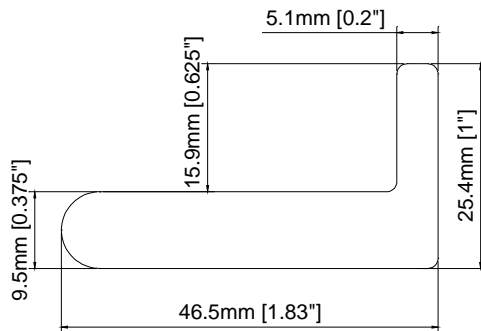

1.83" Sill plate with 5/8" light block  
(For 2.5" Mission Deco frame)

\*Some surcharges apply

# Frame Styles

NORMAN® ULTRA

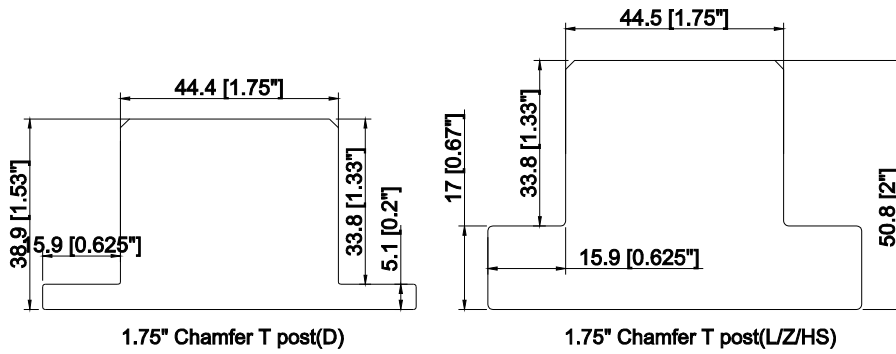

Also available

- Custom width\* up to 7½ for T Posts
  - Size limits (7 1/2")
  - That a surcharge applies and customers should refer to their shutter pricing
  - Any limitations

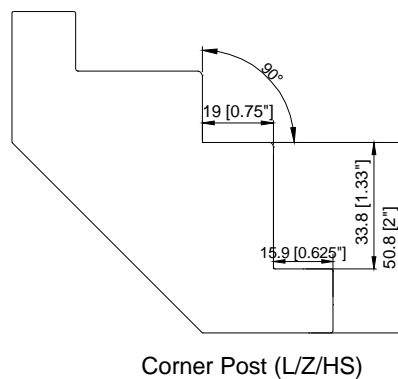
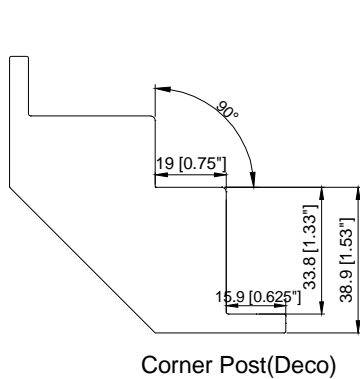
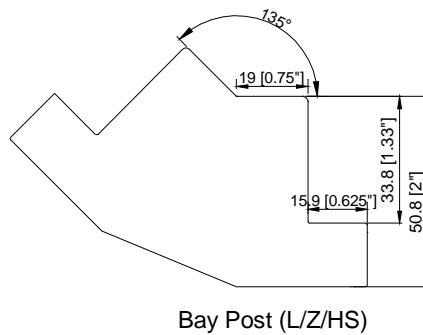
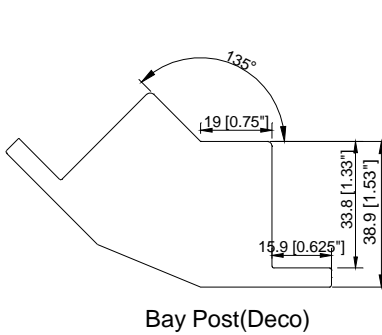
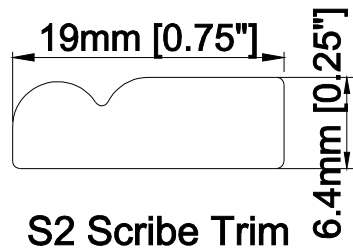
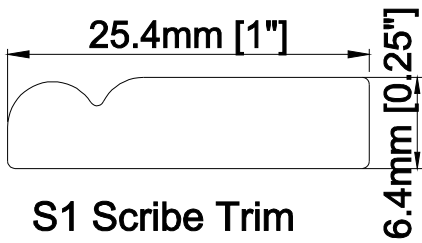

Also available

- Custom angle bay posts\*

\*Some surcharges apply

# Frame Styles

NORMAN® ULTRA

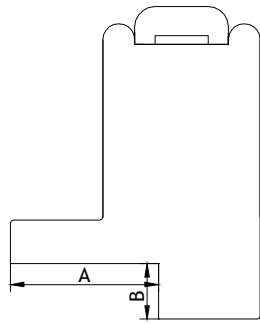
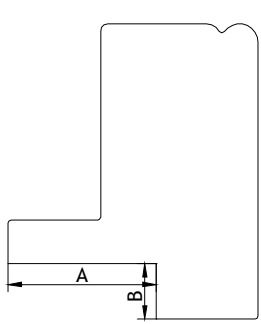

Limitation for the Notch Out Size:

$$A \leq 1"; B \leq 3/8"$$

Notch Out  
Beaded L Frame (A) \*

Notch Out  
Vintage L Frame (A) \*

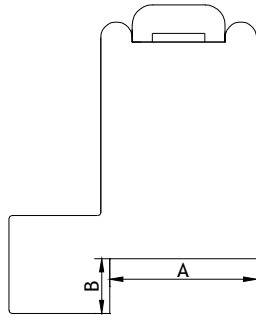
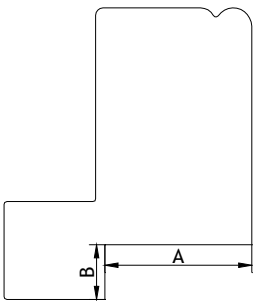

Notch Out  
Beaded L Frame (B) \*

Notch Out  
Vintage L Frame (B) \*

Pre-drill L Frames (Inside Mount Only) or Z frames:

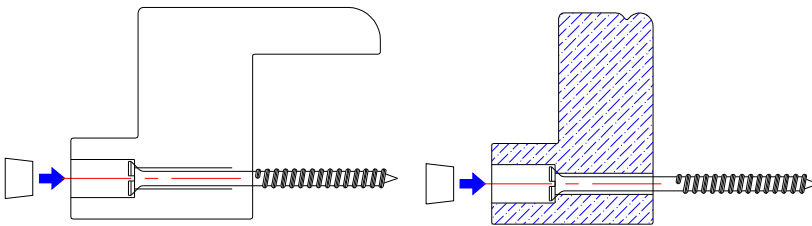

Extension for Deco Frame (Default to have full extension):

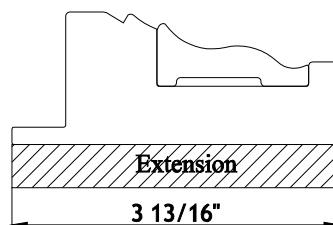
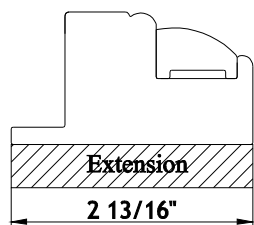
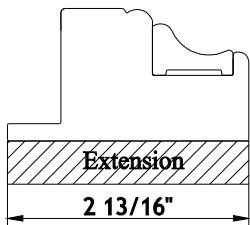

2 3/16" Classic Deco Frame

2 3/16" Camber Deco Frame

3 3/16" Ridge Deco Frame

Note: When the extension thickness of the frame & T post is more than 2", the extension will not be attached with the frame and T post.

\*Some surcharges apply



## Frame Styles

NORMAN® ULTRA

Default principle:

Regarding shutter with horizontal T-post type issue: Horizontal T-Post type will always be the Chamfer T post unless otherwise specified.

# General Product Specifications

■ Panel size limitation

	Panel Configuration		Louver	Minimum	Maximum
Width	Single panel		1 7/8"	6"(2"stile) 6.5"(2.25"stile)	30"
			2 1/2" & 3"		36"
			3 1/2" & 4 1/2"		48"
	Bi fold panel	Hinge bi fold Bi Fold Track	All louvers		26"
		Multifold track up to 4 panels			20"
Height	Single-Panel Height	Ultra Invisible Hinge	All louvers	12"	144"
		Self Mortise Hinge			
	Divider Rail	84" ≤ Panel Height < 132" one divider rail 132" ≤ Panel Height ≤ 144" two divider rails			
Shutter Maximum Width (Without T Post)			4x single panel width (bifold) + frame		
Shutter Maximum Width (With T Post)			Unlimited <b>(For orders shipped by sea, frames longer than 142" will be spliced in the middle. For orders shipped by air, frames longer than 120" will be spliced in the middle.)</b>		
Shutter Maximum Height			144" + frame		

## Shutters without bottom supports

Shutters without bottom supports may sag and deform, including situations below:

1. Shutters with bottom gap over 0.1";
2. Shutters with no frame or no existing sill at the bottom to support the panel (or bottom has frame/existing sill, but the panel keep to open long time without bottom support).

Norman Ultra shutters will be covered by our warranty for this application, subject to our standard specification limitations and the guidelines listed below:

### All Norman Ultra panel configurations:

- You must inform Norman Shutters of situations where shutters will not have bottom support when placing the initial order, or warranty will be considered void.

## NORMAN® ULTRA

- Informing Norman Shutters when placing such orders ensures that the factory will add extra hinges (except Ultra invisible hinge) to support the panel. This will reduce the probability of the panels sagging and increase shutter integrity.
- If you fail to notify Norman Shutters that the shutter will be used without a bottom support or used as doors, this will constitute a misapplication of the shutter. Consequently, you will be responsible for the cost of any RGA Reorder that is submitted.
- If you want a bifold shutter, a track must be ordered to support the panels.

## Tilt Rods

### Standard Tilt Rod

**Default Location:** In the middle of the panel on front side (default).

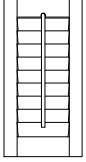

### Offset Tilt Rod

**Default Location:** On the front side of the panel and at 1" from the louver ends on the hinged side.

**Optional location:** per your request

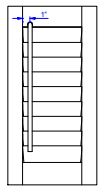

### InvisibleTilt™ \*

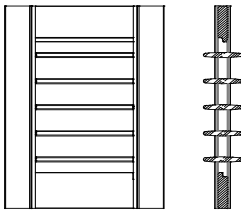

Louver tilting system embedded within panel stile. It is not available for 1<sup>7</sup>/<sub>8</sub>" louver. The tilting system is split when the number of louvers exceeds the limits as listed below:

Louver Size	Maximum Possible Louvers	Panel Height Range
2½"	24	54 ¾" – 57 ¼"
3"	19	54 ¼" - 57"
3½"	16	54 ¾" – 58"
4½"	12	54 ¾" – 60"

For even numbers of louvers, the number of louvers operated by the top and the bottom tilting system will be the same;

For odd numbers of louvers, the number of louvers operated by the bottom tilting system will be one more than the number of louvers operated by the top tilting system;

To ensure split tilt is included, always specify on the order.

### Split Tilt

When selected, the louvers are split evenly by default unless a custom location is requested.

When the customer selects a custom location, the measurement will be as follows (please note that the louvers are in the closed position when measured):

\* Some surcharges apply

# NORMAN® ULTRA

## Window size:

- Measure from the bottom of the window to the top of the louver

## Max frame-to-frame:

- Measure from the bottom of the frame (or panel if there is no bottom frame, sill or sill cap) to the top of the louver.

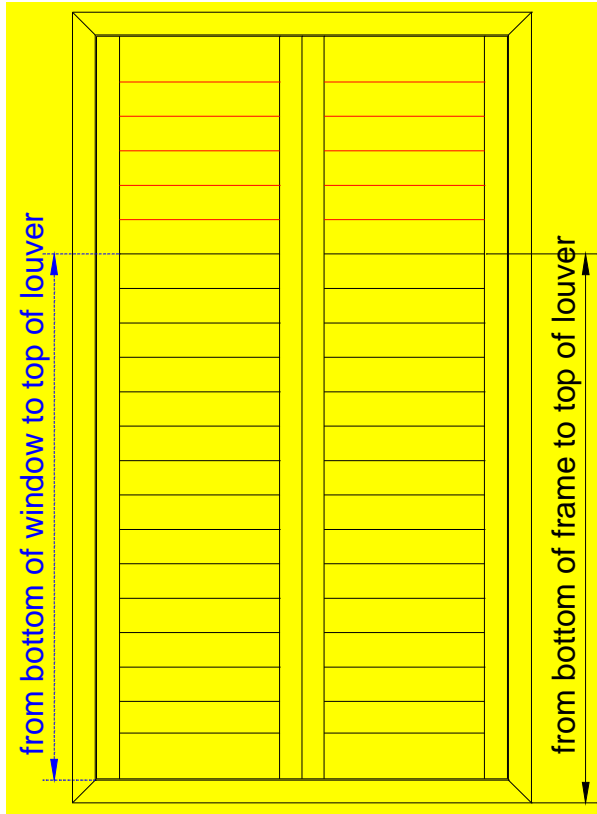

## Split tilt allowable deviations

Louver Size	Allowable ± Deviation
1 7/8"	3/4"
2 1/2"	1"
3"	1 1/4"
3 1/2"	1 1/2"
4 1/2"	2"

## Split Location:

— Per the customer's specification. However, the location of the top louver of the bottom split section may be adjusted to achieve more balanced top and bottom rails when **allow deviations** is selected during order entry. If necessary the location will be moved up from the desired height to ensure any obstruction is covered. The amount of the deviation from the desired height will depend on the size of the louver selected.

If the exact location of the split is critical, customer may select **exact location** in the order entry system when placing the order. This may result in significantly different top and bottom rails. When exact location is selected, a popup will reveal the resulting top and bottom rails measurements from which the customer may either:

1. Accept **the listed top and bottom rail sizes**
2. Modify the split location (sometimes a slight adjustment in the exact split location may achieve desired top and bottom rail **sizes**)
3. Change to **allow deviations** so the system will calculate the split location

**Note:** Top and bottom rail **sizes** may change if the current line item is being matched with another line item. Carefully review all top and bottom rail **sizes** and split locations to ensure a desirable look is achieved

\* Some surcharges apply

NU g-2

# Divider Rails

- A divider rail is an extra rail in the middle of the panel.
- Creates two sections in the panel so louvers can be operated independently.
- Strengthens the panel and enhances panel structural integrity.
- Divider rail is required for panel heights over 84".
- Custom Size(3"~7.875") Divider Rail is available with surcharge.

## Specifications

- Standard width: 3"
- Default location: center of the panel unless specified otherwise

## Measurements:

- Window size:
  - Measure from the bottom of the window to the center of the divider rail.
- Max frame-to-frame:
  - Measure from the bottom of the frame to the center of the divider rail.
- Position:
  - Per customer's specification. However, the divider rail may be adjusted to a lower or higher position, within our allowable deviation to ensure reinforcement and aesthetics of the shutter.

When placing the order, please clearly specify if the divider rail position needs to line up with that of other shutter divider rails in the same room. Please also refer to the table below for the allowable deviation details.

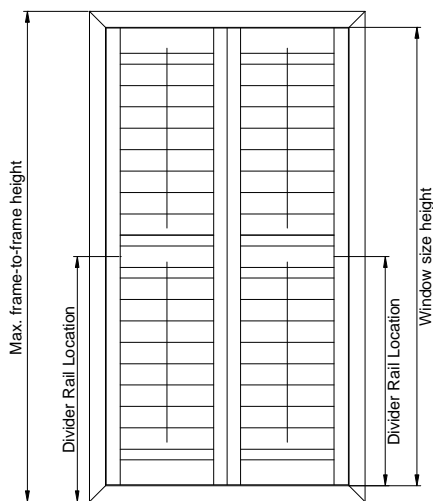

## Divider rail allowable deviations

Louver Size	Allowable $\pm$ Deviation
1 $\frac{7}{8}$ "	$\frac{3}{4}$ "
2 $\frac{1}{2}$ "	1"
3"	1 $\frac{1}{4}$ "
3 $\frac{1}{2}$ "	1 $\frac{1}{2}$ "
4 $\frac{1}{2}$ "	2"

# Hardware

## Hinges

Self-Mortise Hinge

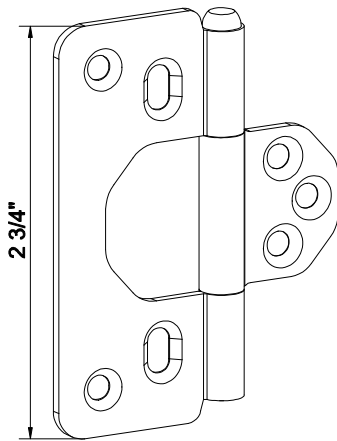

Bi-fold Hinge

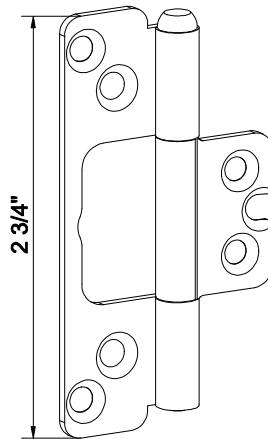

Direct Mount 3" Hinge

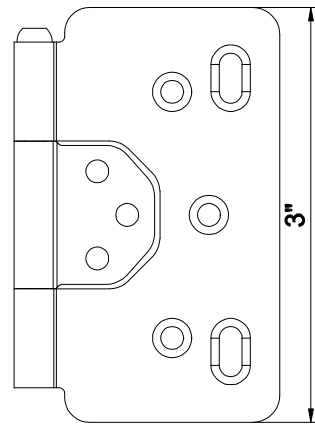

Hinges are available in:

Pure White, Silk White, Bisque, Pearl, Bright Brass, Antique Brass, Black, Nickel plated, Brushed Nickel, Stainless Steel\*, Crisp Linen, String, Sea Mist, Stone Gray, Brown Gray, Taupe Gray.

While hinge colors of Crisp Linen, String, Sea Mist, Stone Gray, Brown Gray, Taupe Gray are not available for Direct mount 3" Hinges.

➤ Direct Mount 3" Hinge:

1. The hinge position of the direct mount 3" hinge will be different from that of the 2.7" ones. For shutters used both the 2.7" and the direct mount 3" hinge, the hinge position of the 2.7" ones will match that of the direct mount 3" hinge;
2. The hinge is only to install between the panel and the existing window. For other situation, 2.7" hinges will be used;
3. To avoid conflict, there will be cut-out for the light block of the hinged side.

Please refer to the drawing below.

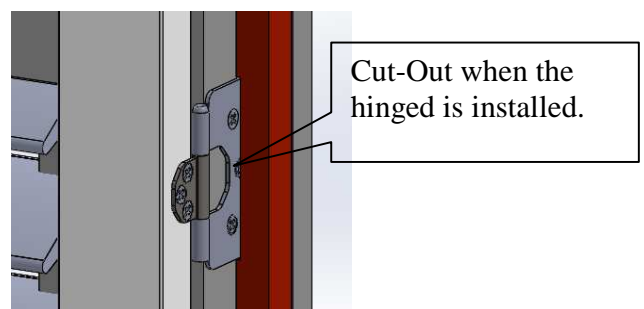
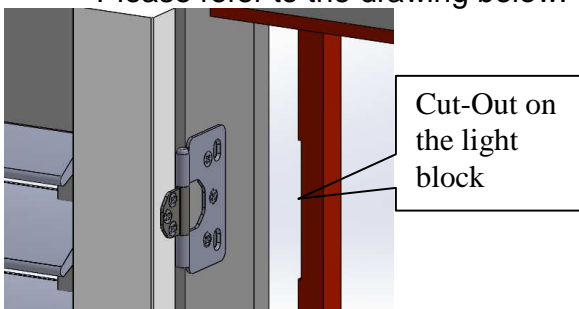

\*Some surcharges apply

# NORMAN® ULTRA

4. Direct Mount 3" Hinge is not suitable for drywall installations.

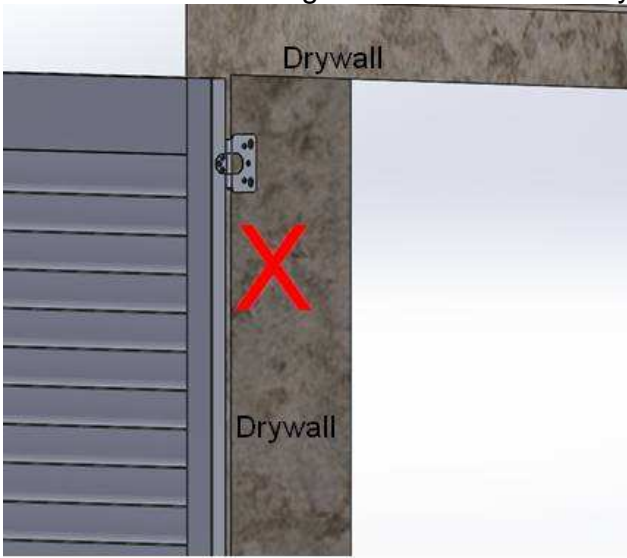

Direct Mount 3" hinge is not suitable for drywall installations.  
It's not recommended.

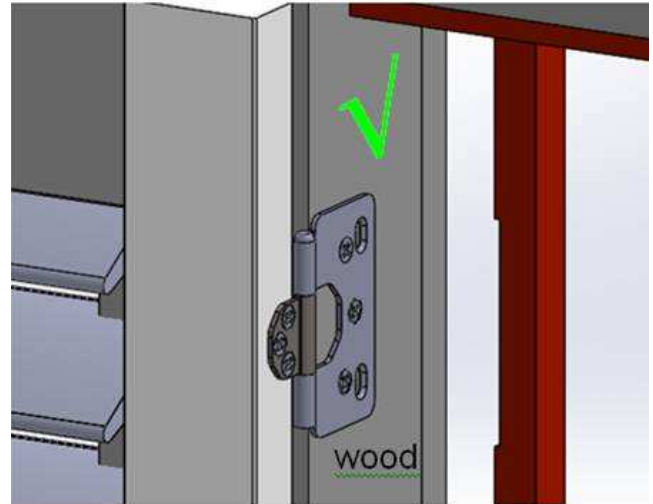

It's acceptable.

**Ultra Invisible Hinge-Optional:** (Silver/Black/Champagne): used between panel and frame/T-post.  
(Not available for Direct Mount)

## Norman® Ultra Hinge Colors

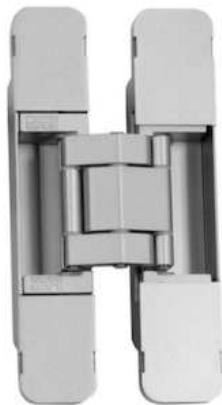
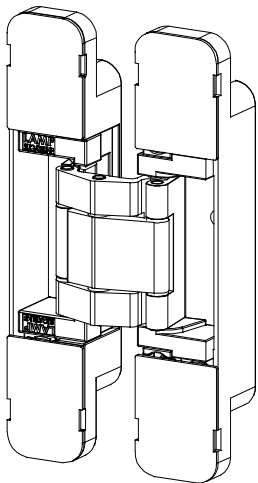

Silver



Champagne



Black

Ultra invisible Hinge Qty:

Panel height	No. of hinges
$H \leq 78"$	2
$78" < H \leq 110"$	3
$H > 110"$	4

\*Some surcharges apply



# NORMAN® ULTRA

## Panel Lock:

Available Material: All

Color: Brush Nickel Plated

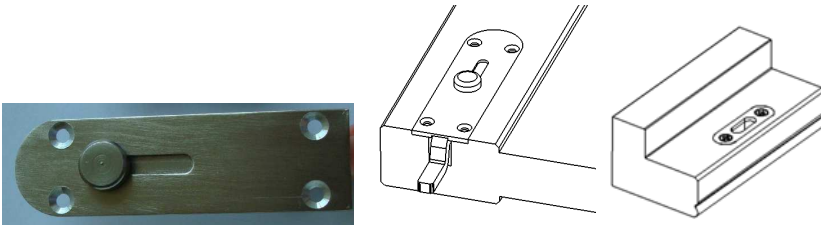

Position: (Only available on Bottom for Track Shutters with Bottom Track; For Regular, available on Top/Bottom/both Top and Bottom)

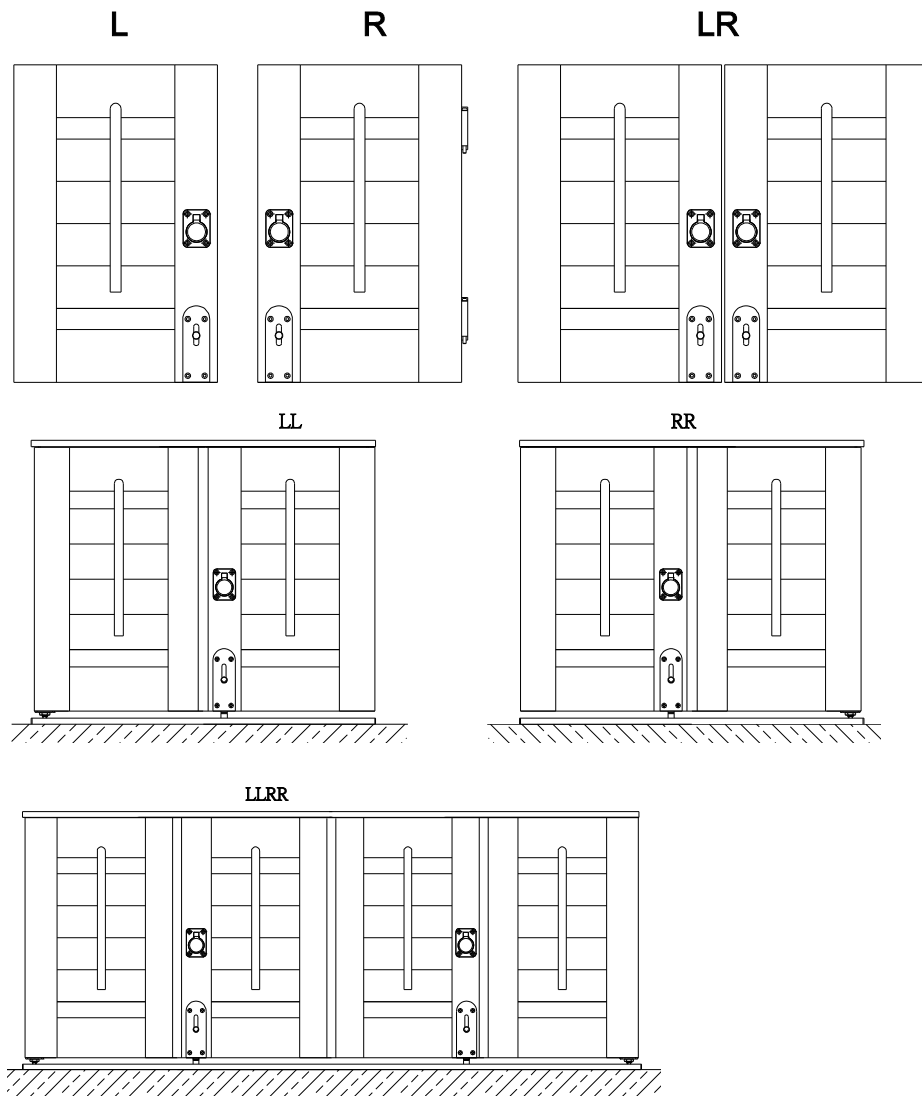

The Panel Lock location for both track system shutters and regular shutters would be the same.

\*Some surcharges apply

# NORMAN® ULTRA

**Ring pull:** for easy opening and closing .

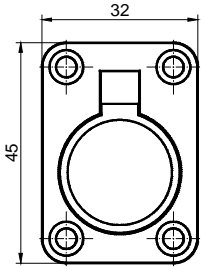

## Ring pull location principle for Floating Panels:

1. When floating panel config is in pairs, it will be split into halves, the left will be for LL and the right will be for RR. So the ring pull location for FF/FF, FF/FF/FF/FF will be same as that of panel config as LL/RR, LL/LL/RR/RR.
2. When floating panel config is FF, the ring pull location will be same as that of panel config LL.
3. When floating panel config is FFFF/FF, the ring pull location will be same as that of panel config LLLL/RR.
4. When floating panel config is singular, it will be split into 3 sections, the left and mid sections are for LL and the right section is for RR. So the ring pull location for FF/FF/FF, FF/FF/FF/FF/FF will be same as that of LL/LL/RR, LL/LL/LL/RR/RR.

Please note the ring pull color will match with the hinge color.

When shutter order with Ultra Invisible Hinge, the ring pull color will match with the normal hinge color.

Please see the matching chart below:

Hinge color	Pure White	Silk White	Bisque	Pearl	Black	Nickel Plated	Brushed Nickel	Antique Brass	Bright Brass	Stainless Steel
Ring Pull color	White	White	Bisque	Pearl	Black	Brushed Nickel	Brushed Nickel	Antique Brass	Bright Brass	Brushed Nickel

Hinge color	Crisp Linen	String	Sea Mist	Stone Gray	Brown Gray	Taupe Gray
Ring Pull color	Bisque	Bisque	Brushed Nickel	Brushed Nickel	Brushed Nickel	Brushed Nickel

Color ID	Color Name	2.7" Hinge color (Default)	Direct Mount 3" Hinge color (Default)	T post connector color	Ring pull color	Top Track color (Default)	Ultra invisible hinge
001	Pure White	Pure White	Pure White	Pure White	White	White	Silver
002	Extra White	Silk White	Silk White	Silk White	White	White	Silver
003	Silk White	Silk White	Silk White	Silk White	White	White	Silver
004	Bright White	Silk White	Silk White	Silk White	White	White	Silver

\*Some surcharges apply

# NORMAN® ULTRA

006	Pearl	Pearl	Pearl	Pearl	Pearl	White	Silver
007	Ivory Lace	Bisque	Bisque	Bisque	Bisque	White	Silver
009	Creamy	Pearl	Pearl	Pearl	Pearl	White	Silver
012	Crisp Linen	Crisp Linen	Bisque	Bisque	Bisque	White	Silver
016	Butter	Crisp Linen	Bisque	Bisque	Bisque	White	Silver
019	String	String	Bisque	Bisque	Bisque	White	Silver
030	Moon dust	Sea Mist	Nickel Plated	Nickel Plated	Brushed Nickel	Anodised Silver	Silver
032	Sea Mist	Sea Mist	Nickel Plated	Nickel Plated	Brushed Nickel	Anodised Silver	Silver
042	Hall Gray	Sea Mist	Nickel Plated	Nickel Plated	Brushed Nickel	Anodised Silver	Silver
046	Ice	Silk White	Silk White	Silk White	White	White	Silver
048	Chai	Nickel Plated	Nickel Plated	Nickel Plated	Brushed Nickel	Anodised Silver	Champagne
049	Stone Gray	Stone Gray	Nickel Plated	Nickel Plated	Brushed Nickel	Anodised Silver	Champagne
051	Brown Gray	Brown Gray	Nickel Plated	Nickel Plated	Brushed Nickel	Anodised Silver	Champagne
053	Clay	Nickel Plated	Nickel Plated	Nickel Plated	Brushed Nickel	Anodised Silver	Black
063	Decorators White	Silk White	Silk White	Silk White	White	White	Silver
066	Winchester White 2010	Pearl	Pearl	Pearl	Pearl	White	Silver
073	Sky Gray	Silk White	Silk White	Silk White	White	Anodised Silver	Silver
074	Element Gray	Sea Mist	Nickel Plated	Nickel Plated	Brushed Nickel	Anodised Silver	Silver
075	Storm Gray	Sea Mist	Nickel Plated	Nickel Plated	Brushed Nickel	Anodised Silver	Silver
077	Dawn	Silk White	Silk White	Silk White	White	White	Silver
078	Cloud Blue	Silk White	Silk White	Silk White	White	White	Silver
080	Taupe Gray	Taupe Gray	Nickel Plated	Nickel Plated	Brushed Nickel	Anodised Silver	Silver
836	Classic Black	Black	Black	Black	Black	Anodised Silver	Black

Color ID	Color Name	2.7" Hinge color (Default)	Direct Mount 3" Hinge color (Default)	T post connect or color	Ring pull color	Top Track color (Default)	Ultra invisible hinge
108	Rustic Gray	Nickel Plated	Nickel Plated	Nickel Plated	Brushed Nickel	Anodised Silver	Champagne
109	Weathered Teak	Nickel Plated	Nickel Plated	Nickel Plated	Brushed Nickel	Anodised Silver	Champagne
110	Limed White	Silk White	Silk White	Silk White	White	White	Silver

\*Some surcharges apply

NU i-5

## NORMAN® ULTRA

111	Pebble	Silk White	Silk White	Silk White	White	White	Silver
200	Natural	Antique Brass	Antique Brass	Nickel Plated	Antique Brass	Coffee	Champagne
202	Golden Oak	Antique Brass	Antique Brass	Nickel Plated	Antique Brass	Coffee	Champagne
205	Goldenrod	Antique Brass	Antique Brass	Nickel Plated	Antique Brass	Coffee	Champagne
212	Dark Teak	Antique Brass	Antique Brass	Nickel Plated	Antique Brass	Coffee	Champagne
215	Cordovan	Antique Brass	Antique Brass	Nickel Plated	Antique Brass	Coffee	Champagne
220	New Ebony	Antique Brass	Antique Brass	Nickel Plated	Antique Brass	Coffee	Champagne
221	Black Walnut	Antique Brass	Antique Brass	Nickel Plated	Antique Brass	Coffee	Black
229	Rich Walnut	Antique Brass	Antique Brass	Nickel Plated	Antique Brass	Coffee	Champagne
230	Old Teak	Antique Brass	Antique Brass	Nickel Plated	Antique Brass	Coffee	Champagne
232	Red Mahogany	Antique Brass	Antique Brass	Nickel Plated	Antique Brass	Coffee	Champagne
237	Wenge	Antique Brass	Antique Brass	Nickel Plated	Antique Brass	Coffee	Champagne
242	Auburn	Antique Brass	Antique Brass	Nickel Plated	Antique Brass	Coffee	Champagne
246	Matte Black	Black	Black	Black	Black	Anodised Silver	Black
248	Pretzel	Antique Brass	Antique Brass	Nickel Plated	Antique Brass	Coffee	Champagne
250	Sumatra	Antique Brass	Antique Brass	Nickel Plated	Antique Brass	Coffee	Champagne
252	Toffee	Antique Brass	Antique Brass	Nickel Plated	Antique Brass	Coffee	Champagne
254	Driftwood	Nickel Plated	Nickel Plated	Nickel Plated	Brushed Nickel	Anodised Silver	Silver
255	Silver Gray	Nickel Plated	Nickel Plated	Nickel Plated	Brushed Nickel	Anodised Silver	Silver
256	Mist	Silk White	Silk White	Silk White	White	White	Silver
862	French Oak	Antique Brass	Antique Brass	Nickel Plated	Antique Brass	Coffee	Champagne

**Position:** For different panel configuration, please refer to the location of Panel Lock to show on which stile the pull will be fixed.

\*Some surcharges apply

NU i-6

# NORMAN® ULTRA

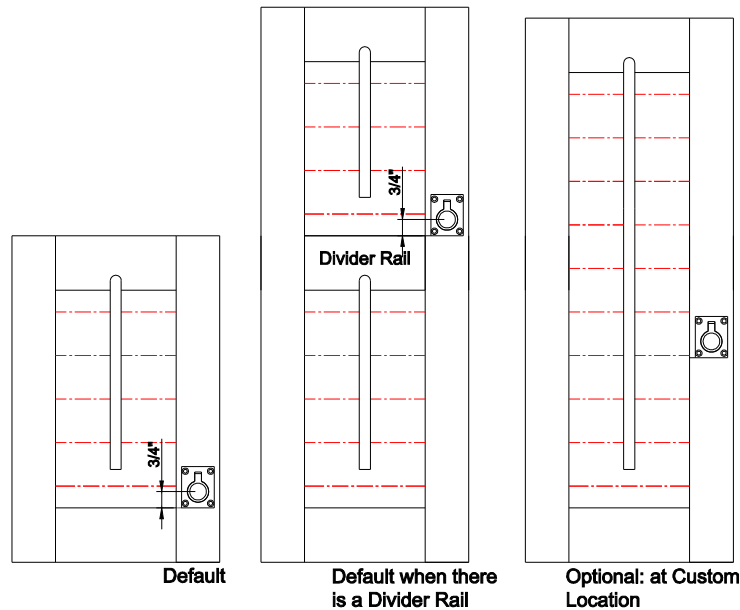

**Position:**

- A. Above Bottom Rail (Default)
- B. Above 1<sup>st</sup> Divider Rail (Default when there are Divider Rails)
- C. Custom Location

If both Panel Lock & ring pull are specified, the distance between them is 2 3/4", and the ring pull location is 6 3/4" from the bottom of panel.

When there is no mid rail, ring pull will be just on the top of Panel Lock (2 3/4" above Panel Lock) as default location; if there are mid rails, bottom of ring pull lines up with top of the 1<sup>st</sup> mid rail as default location.

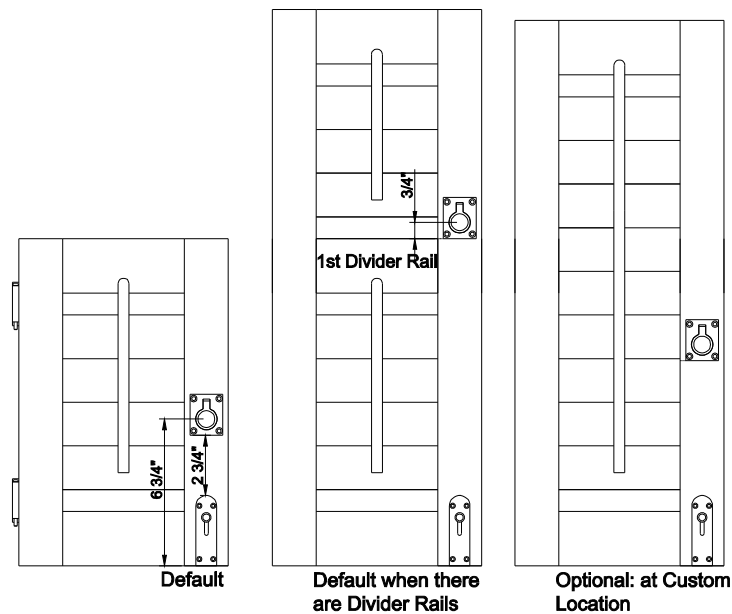

**Position:**

- A. 2 3/4" Above Panel Lock (Default when both Ring Pull and Panel Lock are specified)
- B. Above 1<sup>st</sup> Divider Rail (Default when there are Divider Rails)
- C. Custom Location

\*Some surcharges apply

**Measurements:**

- Window size:
  - Measure from the bottom of the window to the center of the ring pull.
- Max frame-to-frame:
  - Measure from the bottom of the frame to the center of the ring pull.

**Side Magnet: Available for Butt and Rabbet**



Side Magnets will be applied in following situation:

1. Double Hung shutter but without horizontal T post:  
Side magnets will be applied to the meeting stiles of the L and R panel. (Default)

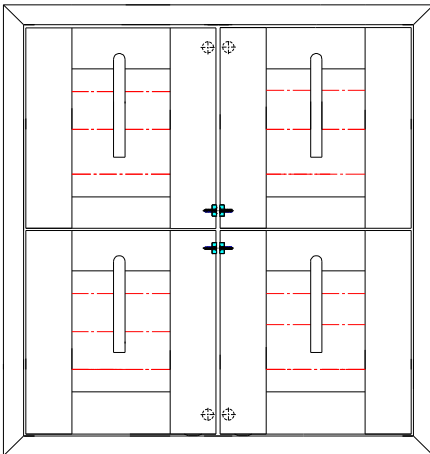

2. Café Shutter  
Side magnets will be applied to the meeting stiles of the L and R panel. (Default)

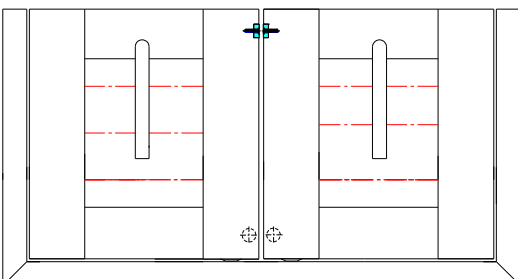

3. No frame or light block or L-shape striker plate on either top or bottom, or if larger than standard top or bottom gap is requested.  
Side magnets will be applied to the meeting stiles of the L and R panel. (Optional)

\*Some surcharges apply

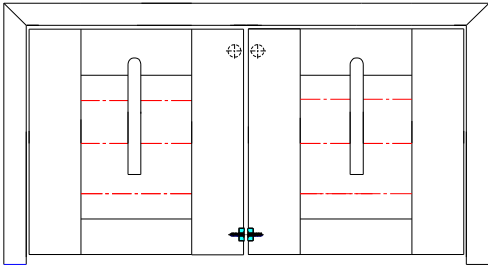

4. Note: if panels only with side magnets and there is no standard magnet on the back of panels, panels may open for external factors.

### T-Post Connector

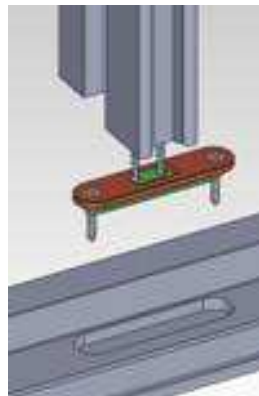
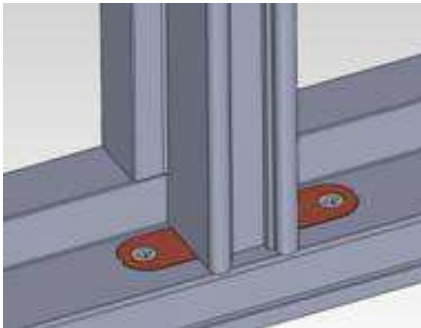

- Available colors: Pure White; Silk White; Pearl; Bisque; Black; Nickel-Plated.
- Available for all types of T Posts (custom-width T posts excluded).

**T Post Connector can be used with the following Frames.**

**L Frame:**

**Deco Frame:**

**Z Frame:**

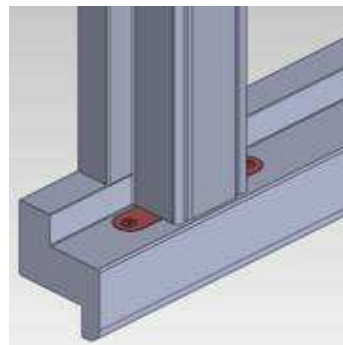
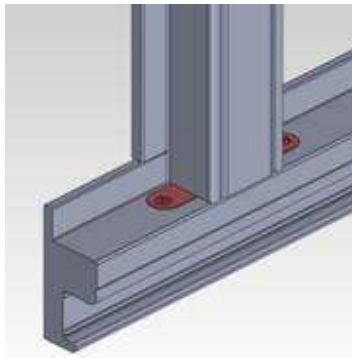
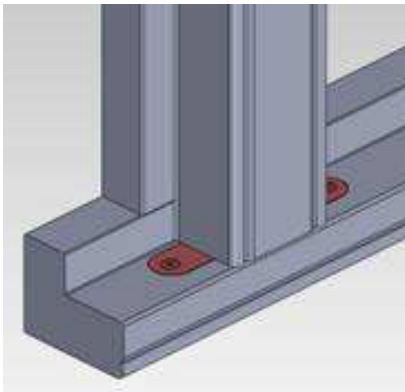

**Hang Strip (Beside)**

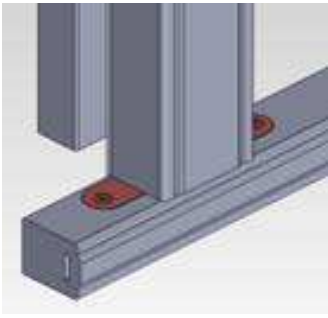

**Note:**

1. For Horizontal T Post, Hang Strip (Behind) and shutter with 1.5"/2" Sill, T Post connector is not available and T Post will be installed by screws instead;
2. If there is a panel lock which may interfere with the T-Post connector, all the T-Posts for the entire shutter will be installed with screws and the frames to be pre-drilled, even in cases where the panel lock may only interfere with one T-Post;
3. The screw color is nickel-plated regardless of the color of the T Post connector;
4. T post connectors can only be installed on a straight piece, and screws will be used instead for T Post installed on a curved or raked piece.

## **Optional Poles:**

### 1. Terminology

---

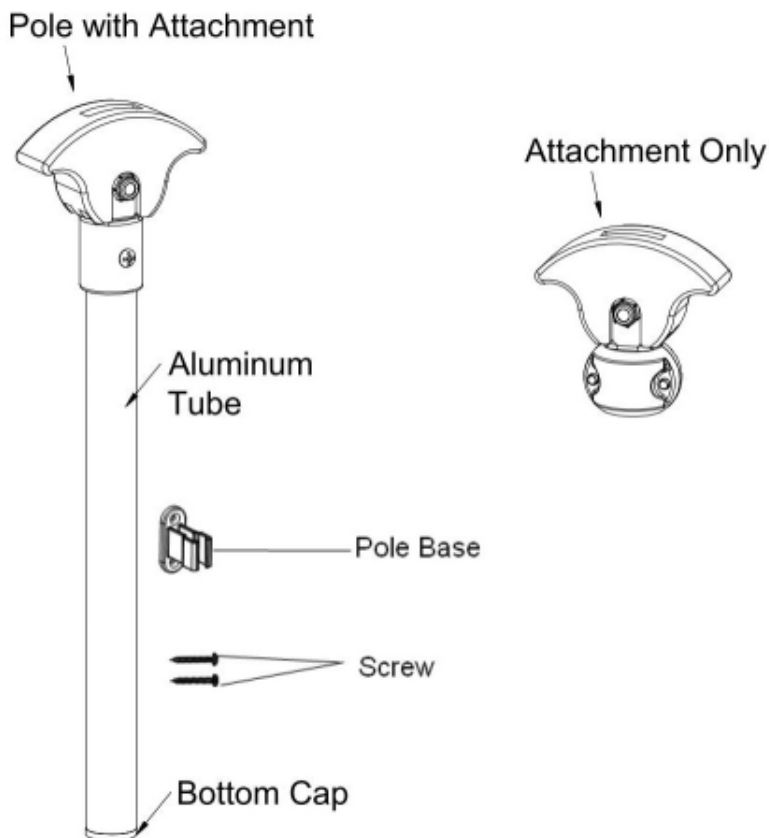

\*Some surcharges apply



Component

NO.	Name	Note
1	Pole with Attachment	Aluminum Tube, Pole Base and Bottom Cap included *Surcharge applies.
2	Attachment only	<ul style="list-style-type: none"> <li>● Compatible with extension poles found in most home improvement stores.</li> <li>● Screw thread (3/4") and thread pitch (1/5")</li> </ul> *Surcharge applies.

2. Available Pole Length

Two lengths available:

- 36"
- 60"

# Bi-fold 180™

## Guidelines and Specs:

<u>Description</u>	<u>Minimum</u>	<u>Maximum</u>
Single-Panel Width (Bi-fold Track)	6"(2"Stile) / 6.5"(2.25" Stile)	26"
Single-Panel Width (LLL/RRR)	6"(2"Stile) / 6.5"(2.25" Stile)	20"
Single-Panel Height	12"	144"

### Outside Mount

Max frame-to-frame width: window width + 3 1/2"

Max frame-to-frame height: window height + 4 1/2"

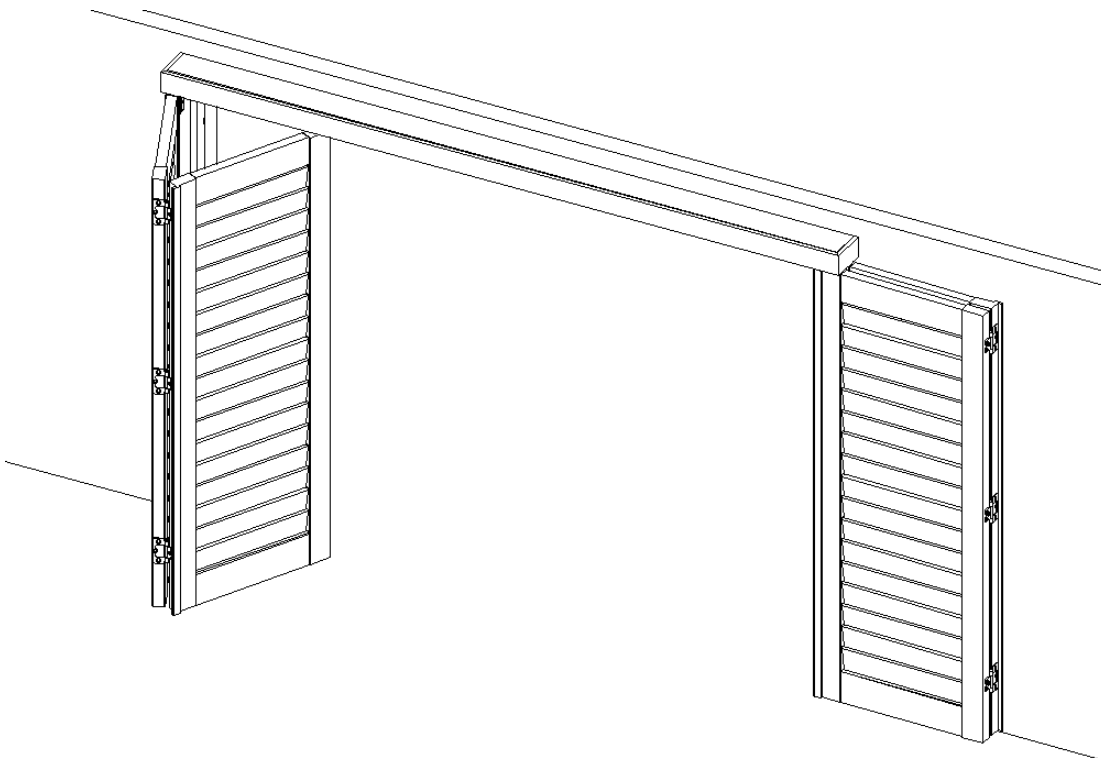

- Track is pre-installed on the header; standard 1 track only.

## Mounting Options: Outside Mount only

### Side View

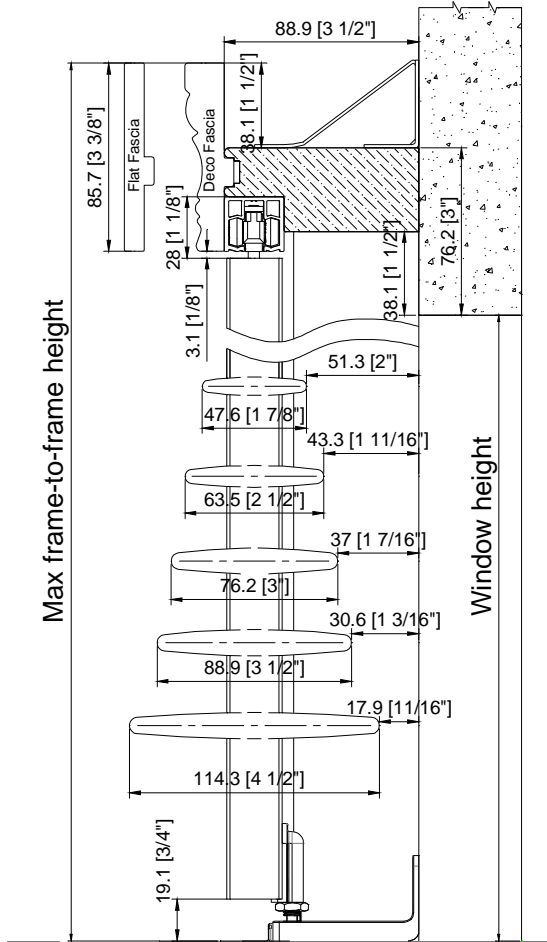

### Top View

#### Without Casing:

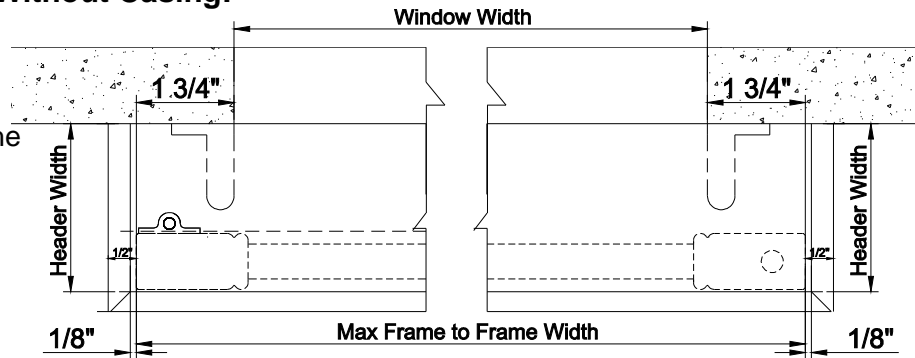

#### Note:

- ◇ Fascia return will protrude the panel about 1/2" for each side.
- ◇ The header will protrude the panel about 1/8" for each side.
- ◇ Header, light blocks, and bottom pivot bracket(s) must be installed on a flat surface.

# NORMAN® ULTRA

## With Existing Casing:

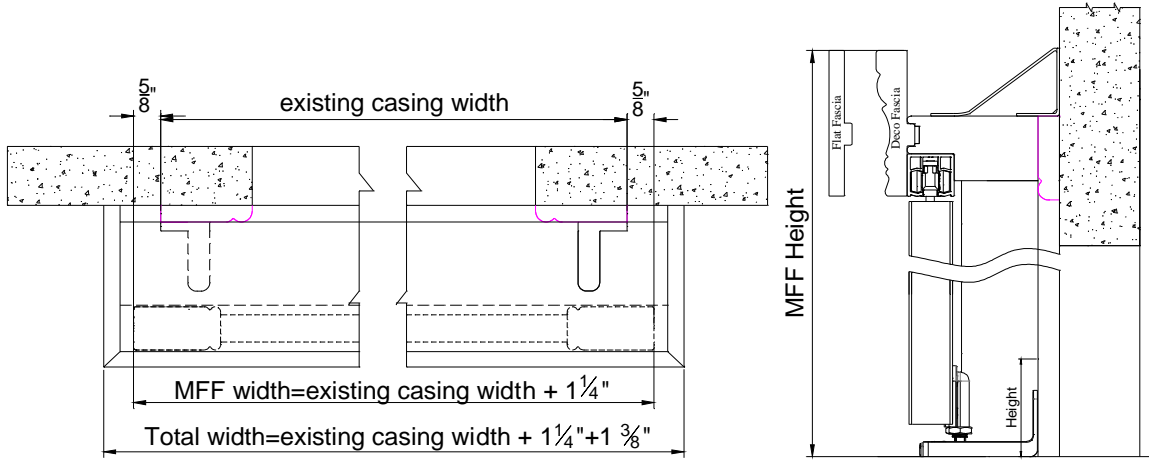

- ✧ Header Extension: Optional
- ✧ Custom extension up to 2" for Header
- ✧ When extension is needed, the header will protrude the panel 5/16" for each side and the fascia return will protrude the panel 11/16" for each side.

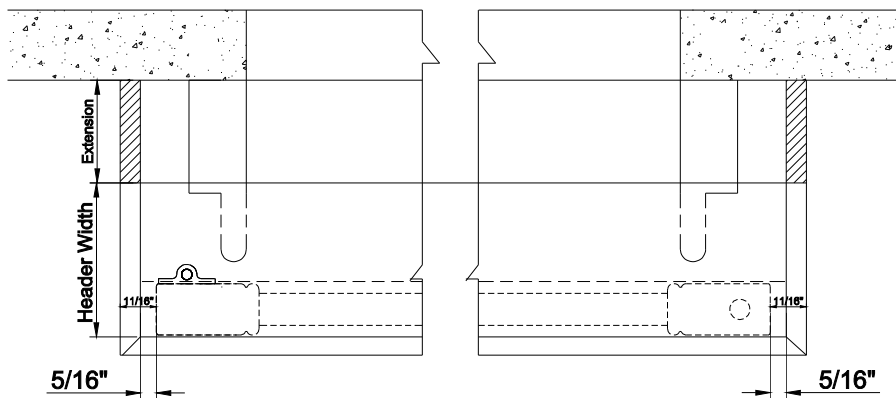

The extension will be pre-attached.

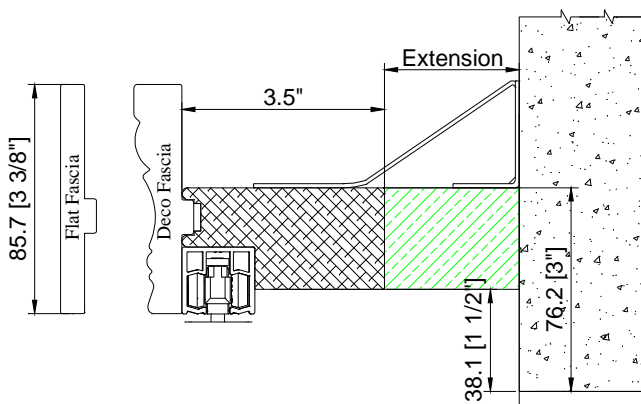

# NORMAN® ULTRA

For 180 Bi-fold, if Bottom Pivot L Bracket is required, the extension for the L shape light block will be  $1\frac{3}{4}$ " in width. Please see picture below:

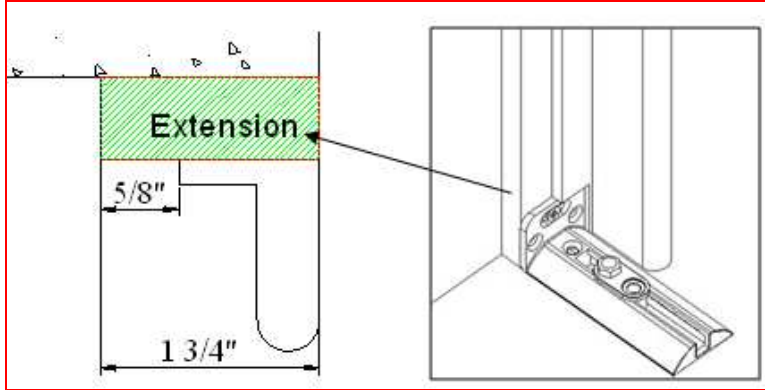

**Panel Configuration : Only 2", 2 1/4" rabbet and butt stiles are available. Center stile is not available.**

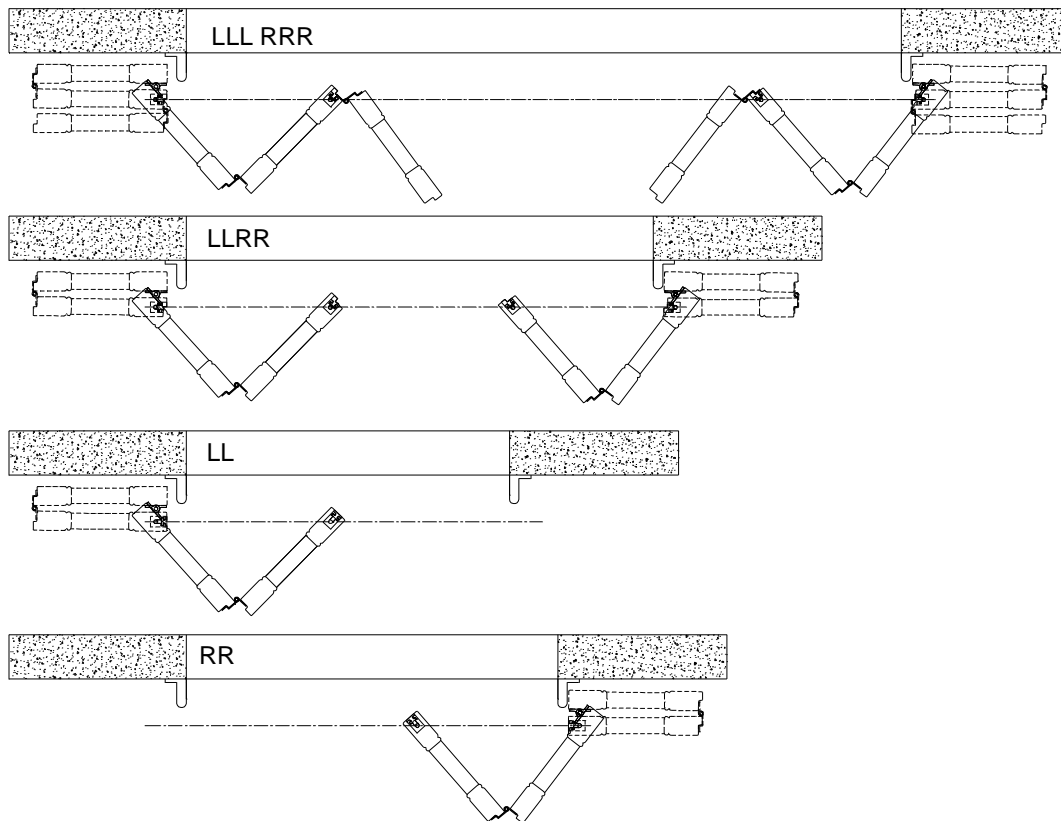

# NORMAN® ULTRA

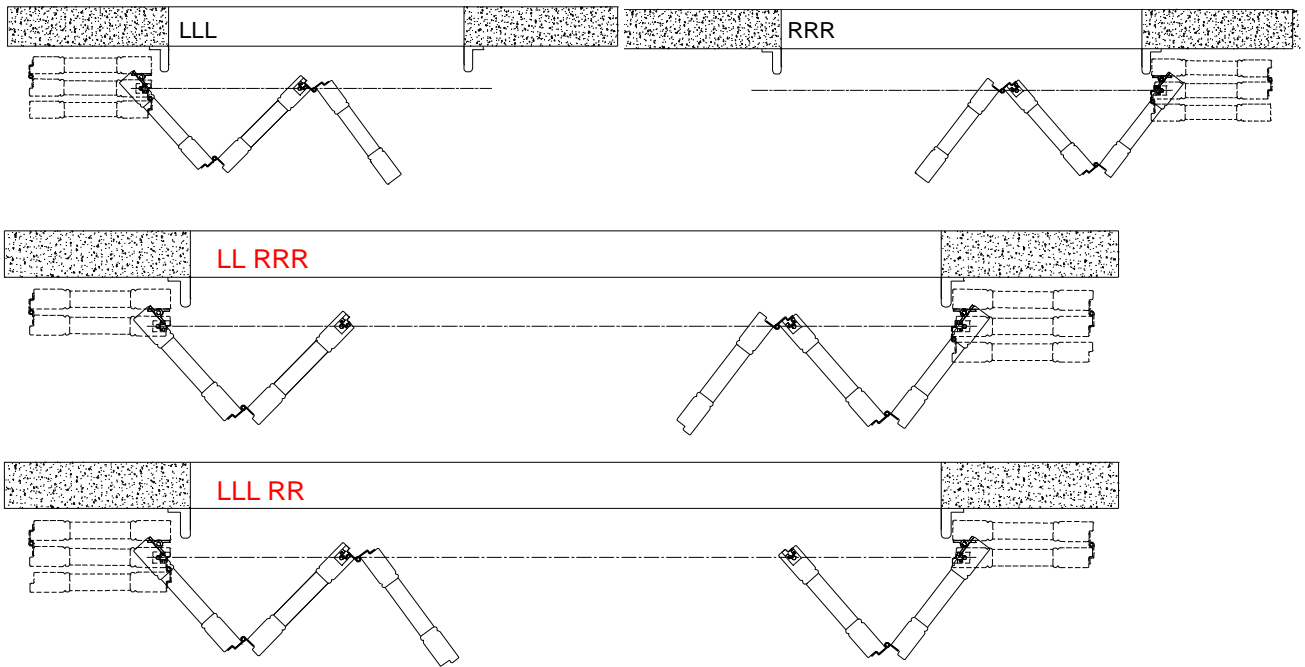

## Notes:

If there is baseboard to the wall, then it should be as below:

1. If base board thickness is less or equal to 5/8", 3 1/2" header can be used.
2. If base board thickness is over 5/8", it is suggest using the 3.5" header with build out. And the build out thickness=base board thickness-1/8".

Please see the drawing below:

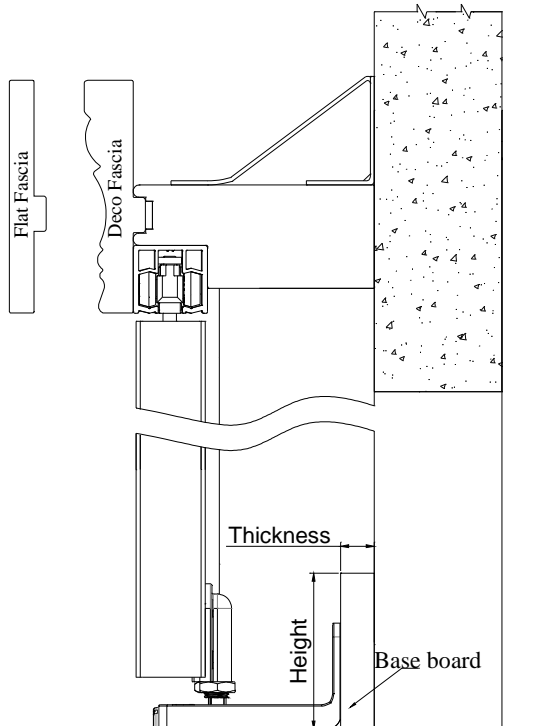

**180° Bi-fold Track Shutters Framing Materials**

Type	Header Dimension	Top Fascia Dimension	L Shape Light Block Strip Dimension
Header & Top Fascia & Light Block Strip	3 1/2"	3 3/8"	1 7/8"

**180° Bi-fold Track Shutters Hardware Box**

Parts
Wrench
Hinge Pin
Support L Bracket (based on the length of header)
2 ½ " screws for support L bracket
¾ " screws for support L bracket
Bottom Pivot Bracket
1 ½ " screws for bottom pivot bracket
2 ½ " screws for Frame with predrilled screw holes

# Bi-fold 90

## Guidelines and Specs:

<u>Description</u>	<u>Minimum</u>	<u>Maximum</u>
Single-Panel Width (Bi-fold Track)	6"(2"Stile) / 6.5"(2.25" Stile)	26"
Single-Panel Width (Multifold track up to 4 panels)	6"(2"Stile) / 6.5"(2.25" Stile)	20"
Single-Panel Height	12"	144"

### Outside Mount

Max frame-to-frame width: window width + 3 1/2"

Max frame-to-frame height: window height + 4 1/2"

### Semi-Inside Mount

Max frame-to-frame width: window width - 1/8"

Max frame-to-frame height: window height + 1 3/8"

### Inside Mount

Max frame-to-frame width: window width - 1/8"

Max frame-to-frame height: window height - 1/8"

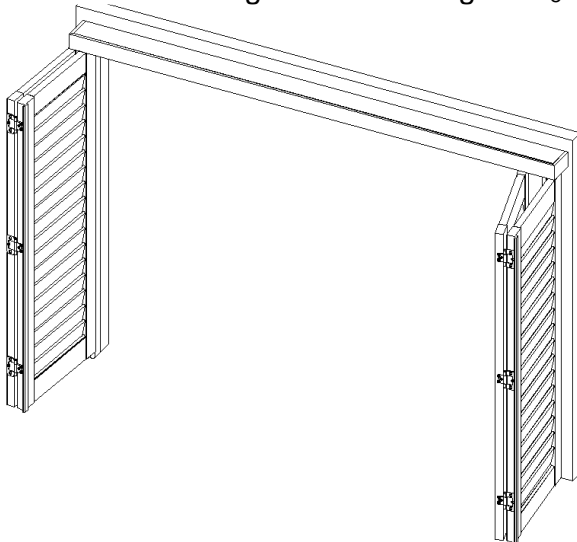

\* Track is pre-installed on the header; standard 1 track only.



## Mounting Options: Outside Mount

### Side View

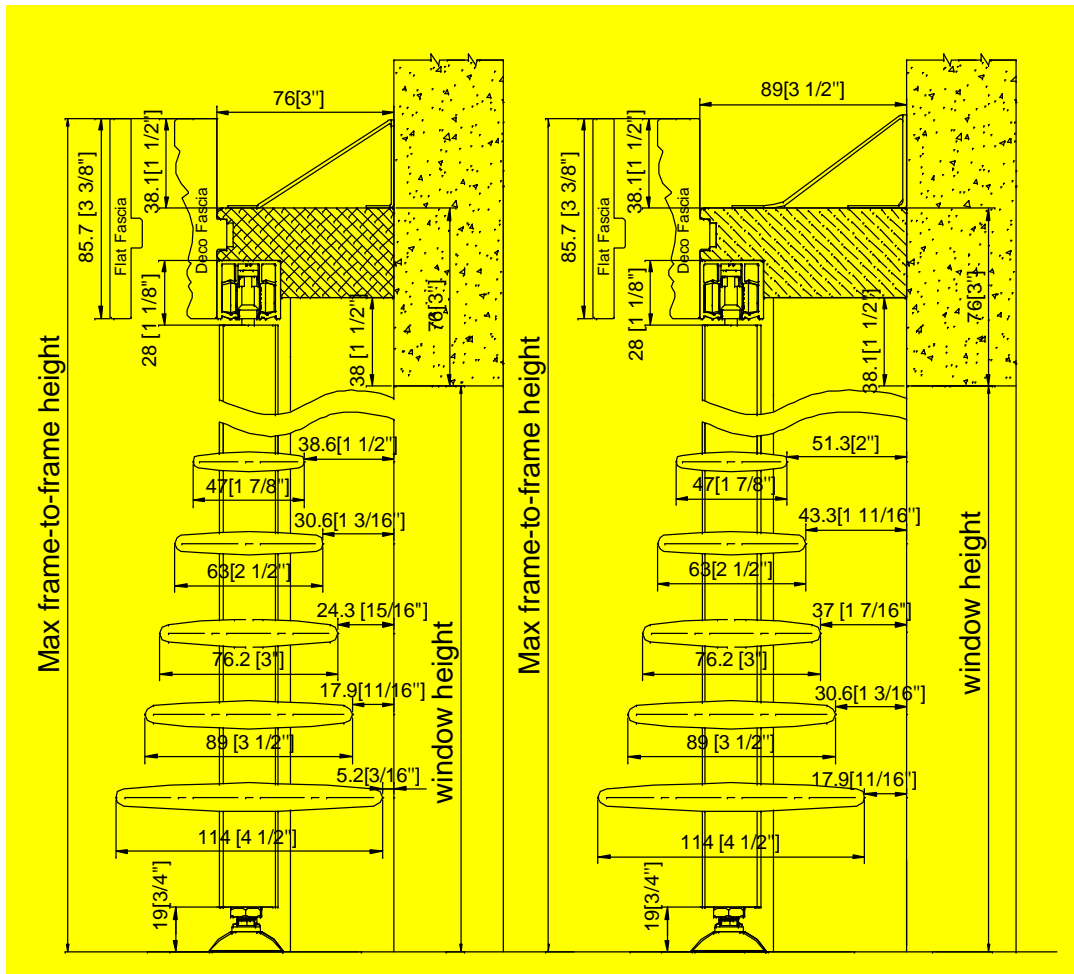

### Top View

#### Without Casing:

Note:

- ◇ Fascia return will protrude the panel about 1/2" for each side.
- ◇ The header will protrude the panel about 1/8" for each side.
- ◇ Header, light blocks, and bottom pivot bracket(s) must be installed on a flat surface.

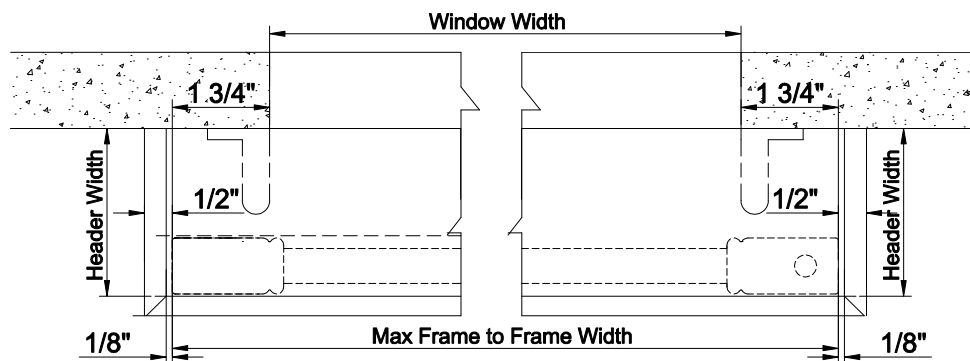

# NORMAN® ULTRA

## With Existing Casing:

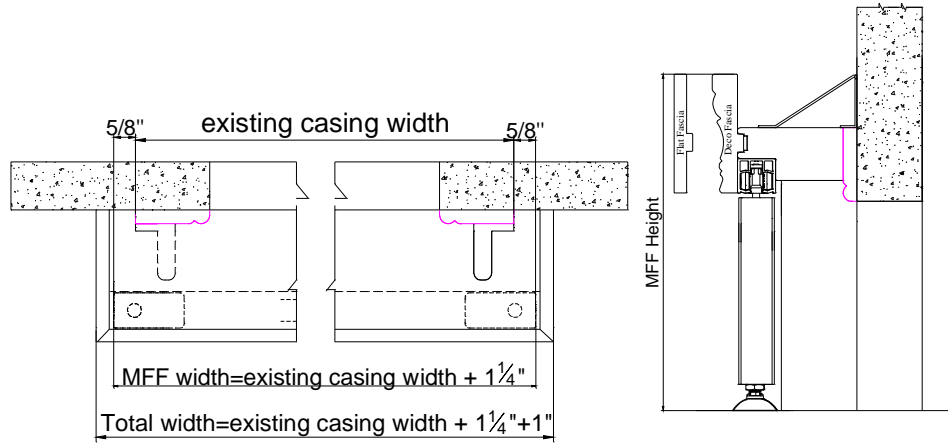

## Semi-Inside/Inside Mount

### Side View

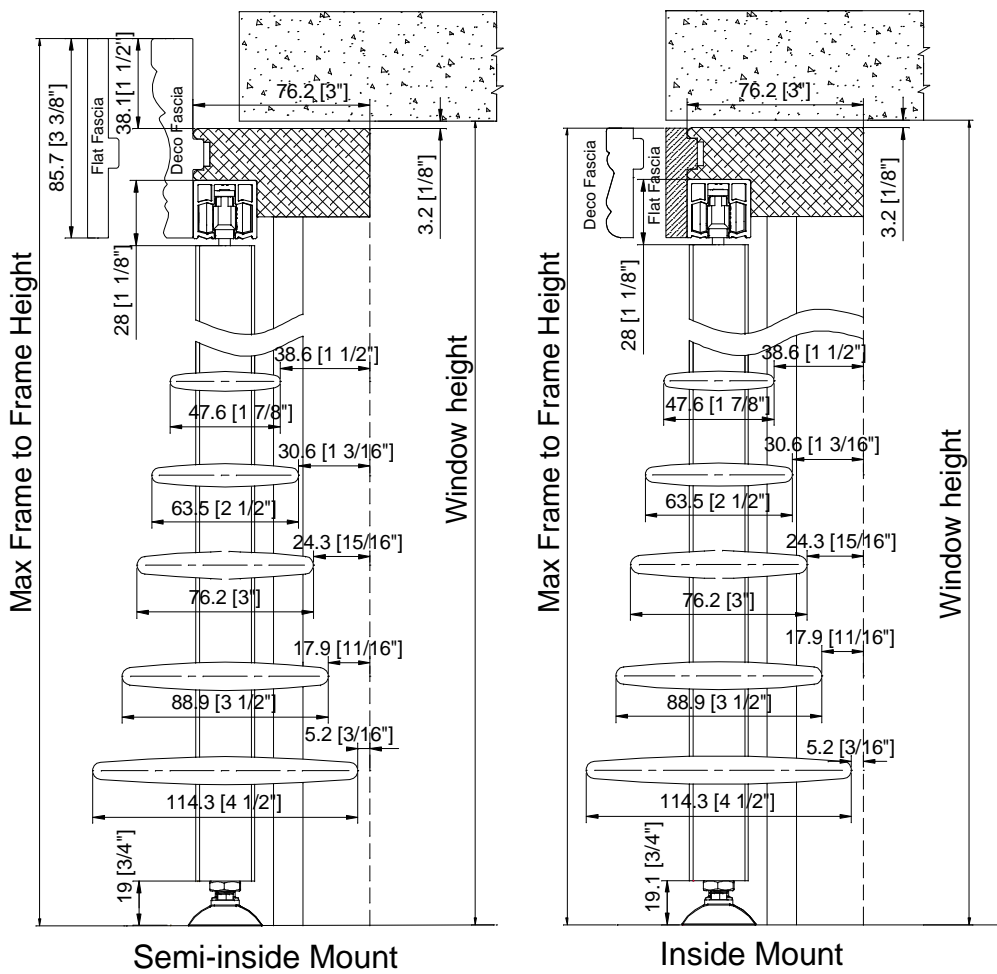

**Semi-Inside Mount Top View**

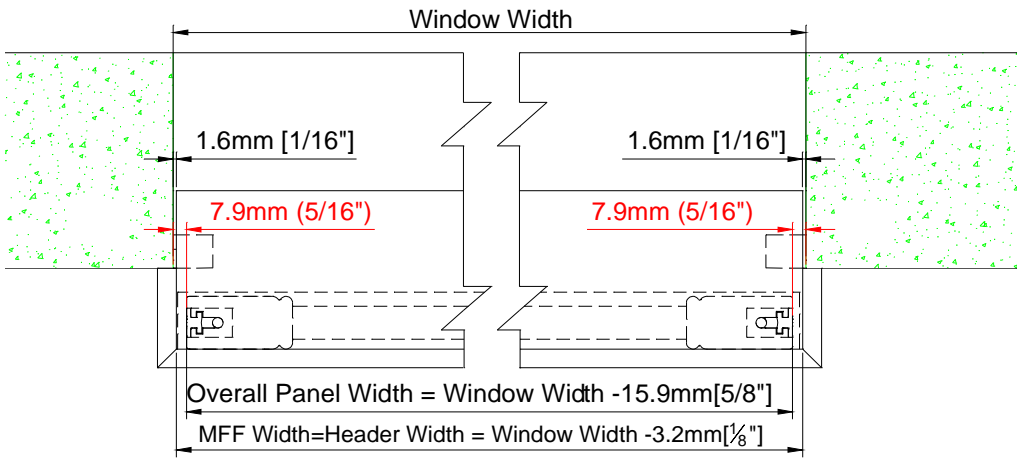

**Inside Mount Top View**

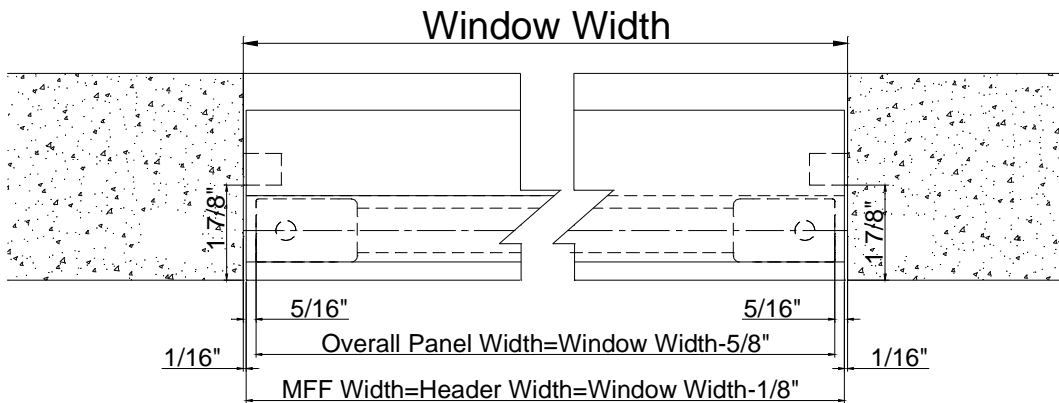

- ◇ Header Extension: Optional.
- ◇ Custom extension up to 2" for Header
- ◇ The extension will be pre-attached.

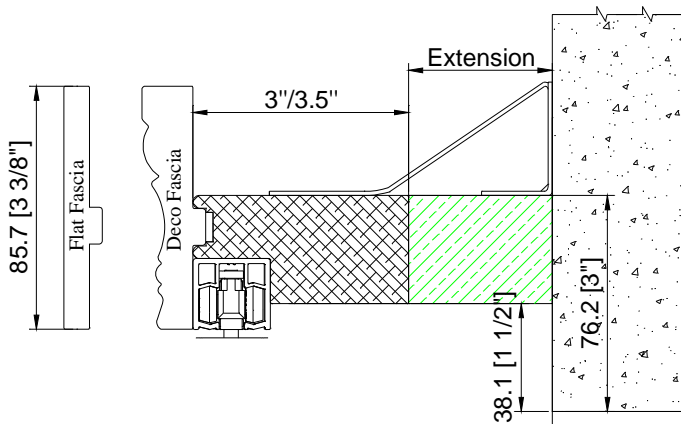



# NORMAN® ULTRA

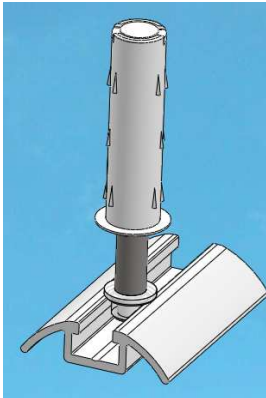

- Two or four panels can be hinged together, fold and slide to either direction
- Application comes with wheel carrier, spring loaded guide and floor track
- Can be used on large window

**Note:**

1. For 90° Floating Panels outside mount/semi-inside mount without side boards, 2016 Stopper will be supplied and the gap between the fascia return / end of top track and the panel is 5mm each side. Please see drawing below to show the gap.

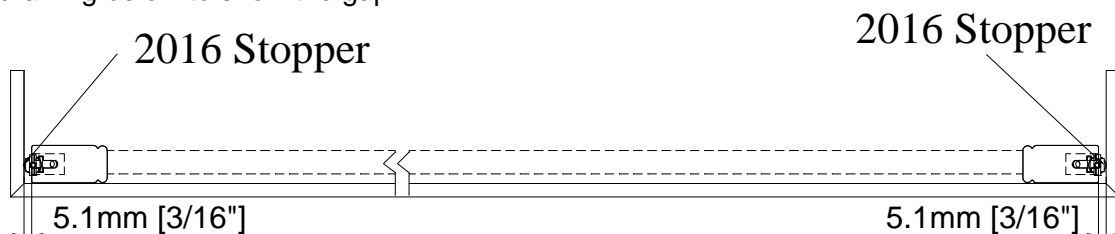

The 2016 Stopper

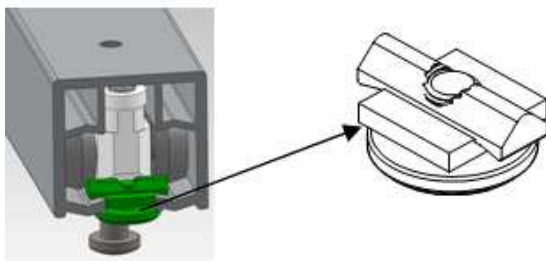

2. When rabbit stile required, the meeting stile of unhinged stile will be butt stile by default.

**90 Degree Bi Fold Track Shutters Framing Materials**

Type		Header Dimension	Top Fascia Dimension	Light Block Strip Dimension
Header & Top Fascia & Light Block Strip	OM	3"	3 3/8"	1 3/8"
		3 1/2"		1 7/8"
	Semi-IM	3"	1 7/8"	5/8"x3/4"
	IM	3"		5/8"x3/4"

Note: It will be L shape light block strip for outside mount.

**Frame Hinged Bifold**  
**Available Stile: Rabbet Stile Only**  
**Available Frame type**

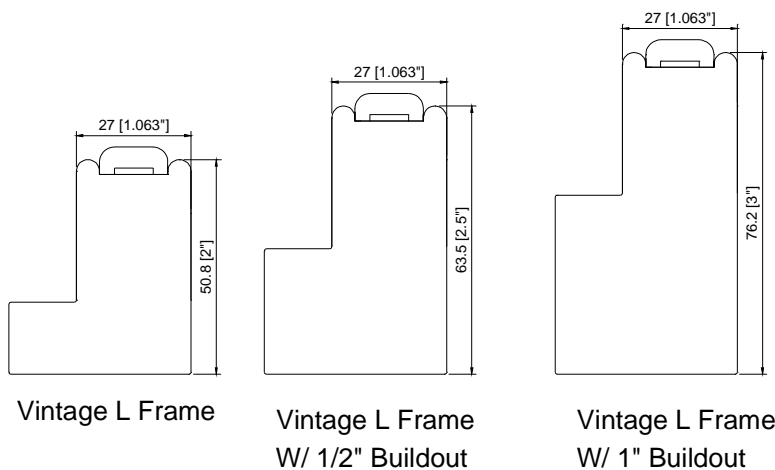
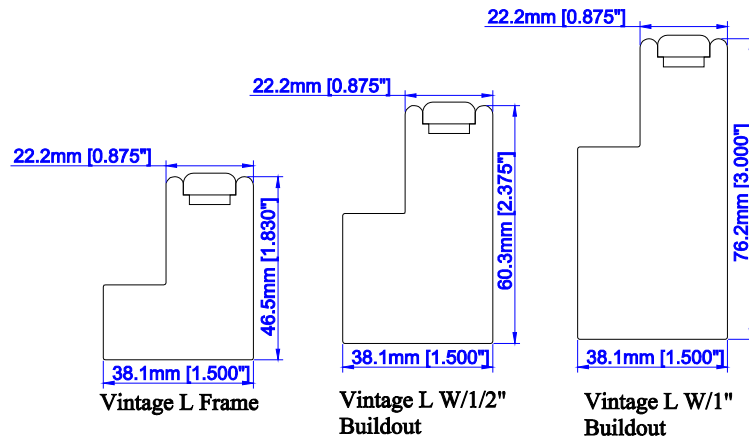

**Vintage Hang Strip with 13mm light block:** For single direction shutter with even panel qty, the frame on the unhinged side will be Vintage Hang Strip with 13mm [0.512"] light block, the height of the Vintage Hang Strip will match with that of the hinged side frame.

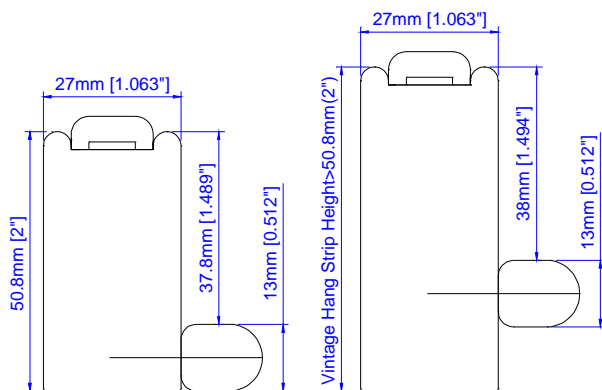

**Top View:** Hinged at Left or Right with wheel assembly at top;

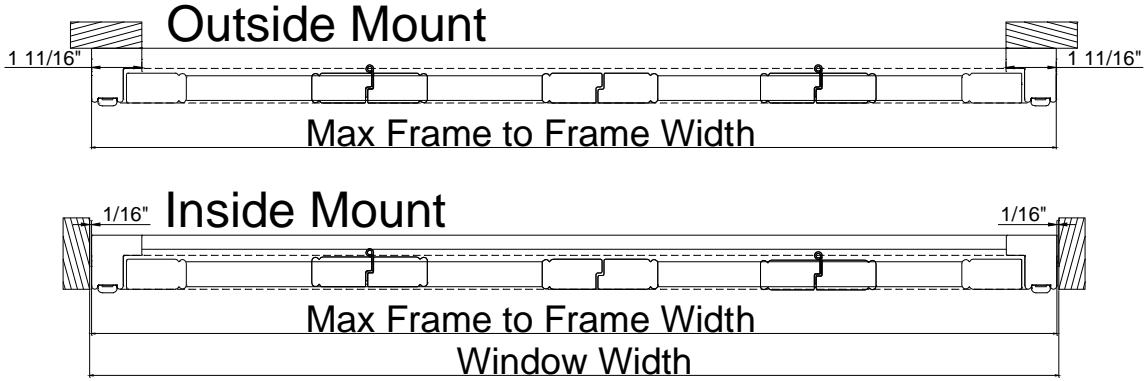

## Side View

Outside Mount

3-Sides + bottom light block

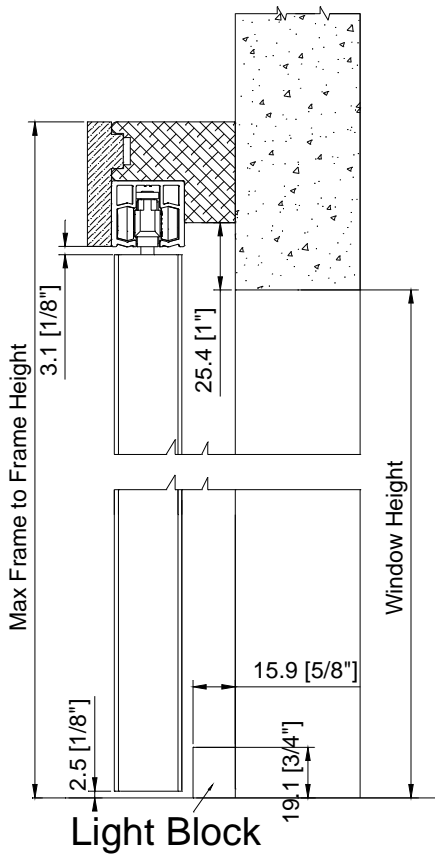

3-Sides + 3" Deco Sill Frame

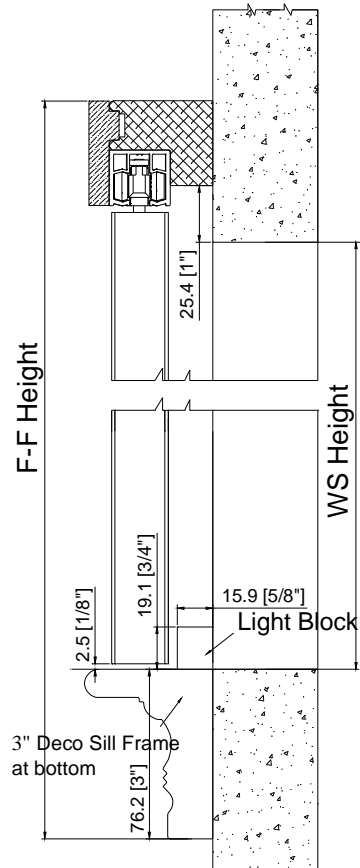

# NORMAN® ULTRA

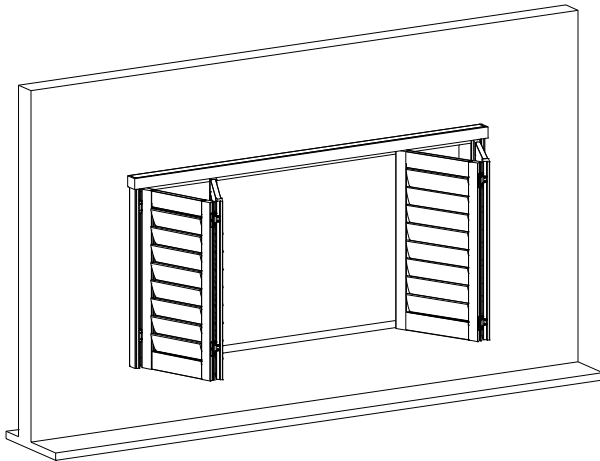

Note: For OM Frame Hinged Bifold shutter not to use as a door, if there is no existing sill at the bottom of the window opening, it is recommended to have the 3" Deco Sill Frame at the bottom.

Semi-Inside

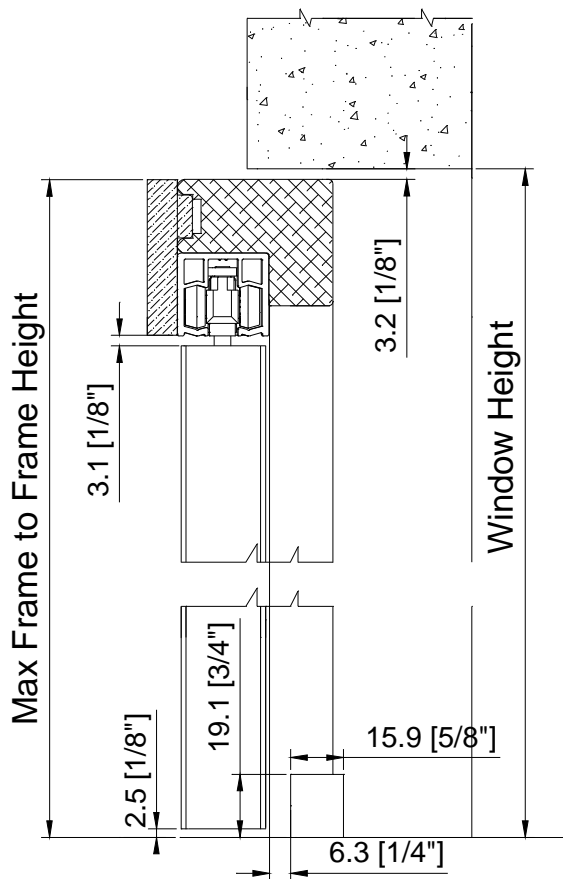

Inside Mount

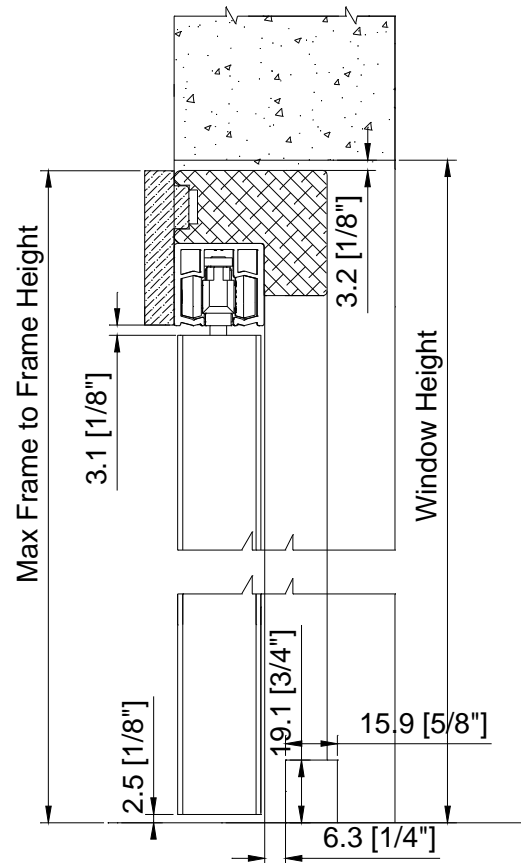



# NORMAN® ULTRA

For frame hinged bifold track shutter used as door, the bottom gap will be 3/4" by default. Please specify "Used As Door" on the order form.

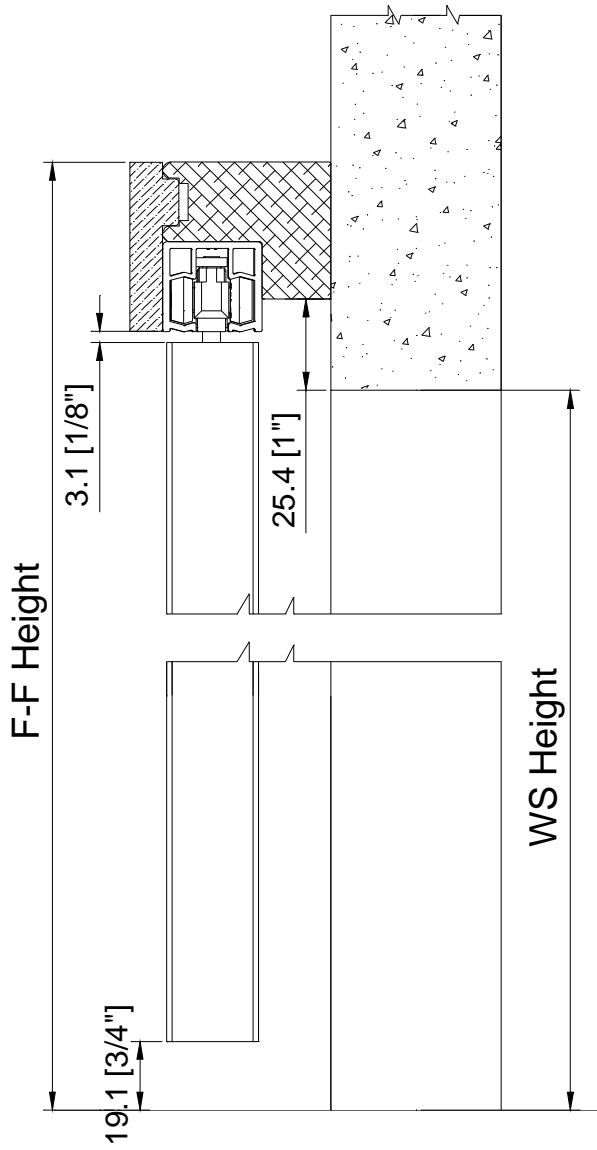

# NORMAN® ULTRA

## Panel Configuration (uneven panel width)

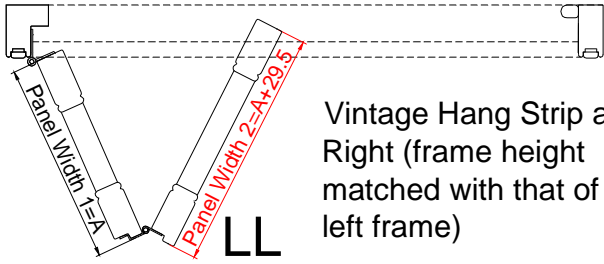

Vintage Hang Strip at Right (frame height matched with that of the left frame)

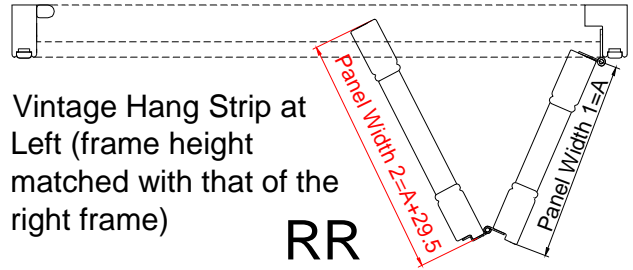

Vintage Hang Strip at Left (frame height matched with that of the right frame)

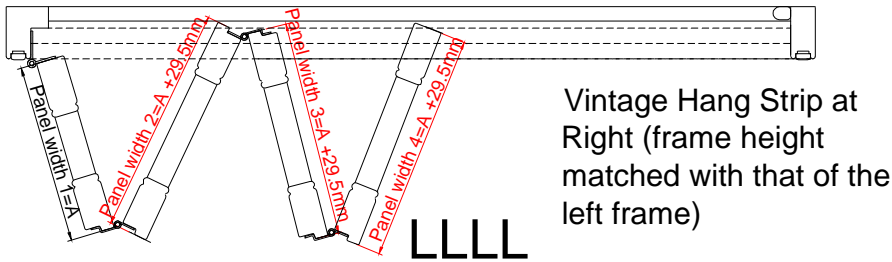
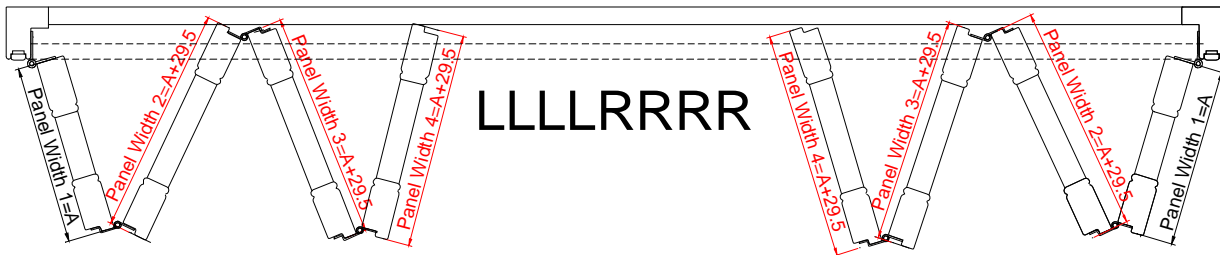
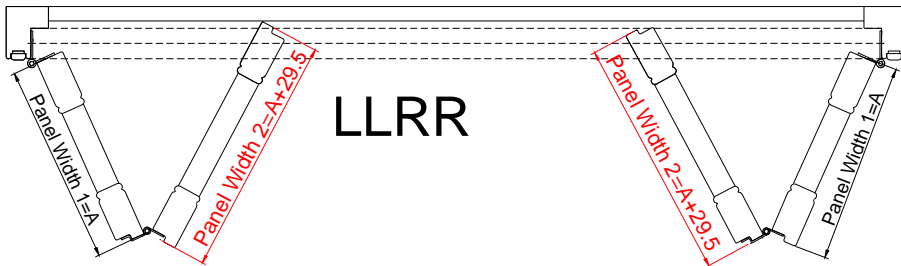

Vintage Hang Strip at Right (frame height matched with that of the left frame)

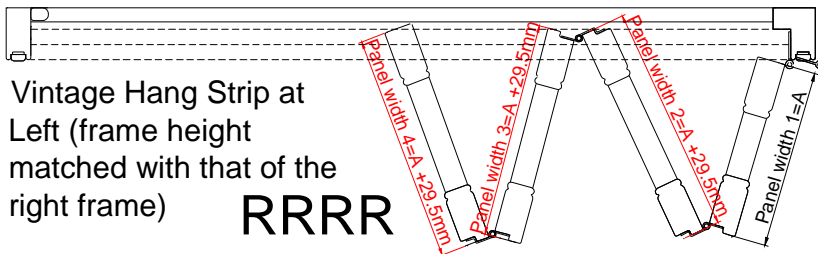

Vintage Hang Strip at Left (frame height matched with that of the right frame)

# NORMAN® ULTRA

## Notes:

1. Only available for 3-Sides + bottom light block or 3-Sides + 3" Deco Sill Frame (4-sides is not available); Panels can be folded and open at 90 degree;

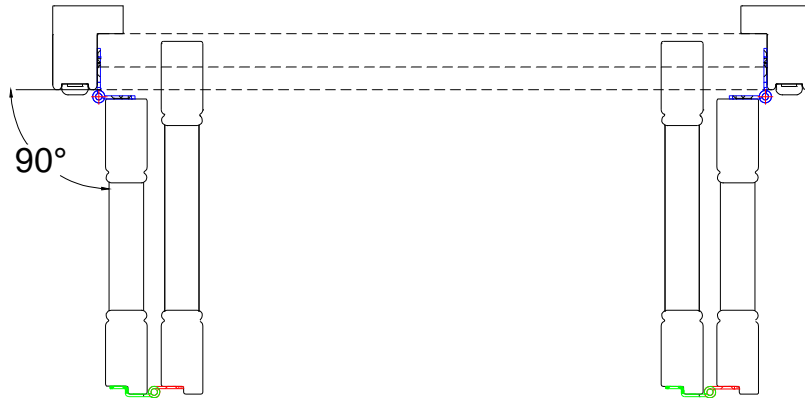

2. Frames available: Only Vintage L Frame

- 1) For top frame, the insert will be replaced by top fascia;
- 2) Top track will be pre-attached to the top frame;
- 3) Frame will be pre-drilled with screw holes same as regular shutters.
- 4) The gap between panel and frame on non-hinged side is 3.5mm (0.138").

**Ring Pull:** The ring pull will be provided as an option; and for frame hinged bi-fold, the ring pull will be supplied as default; Customer need specify ring pull location on the order form. Ring pull location is measured from the floor to center of the ring pull in height direction. Ring pull color will match the hinge color.

Please refer to below drawing of ring pull position for all shutter type:

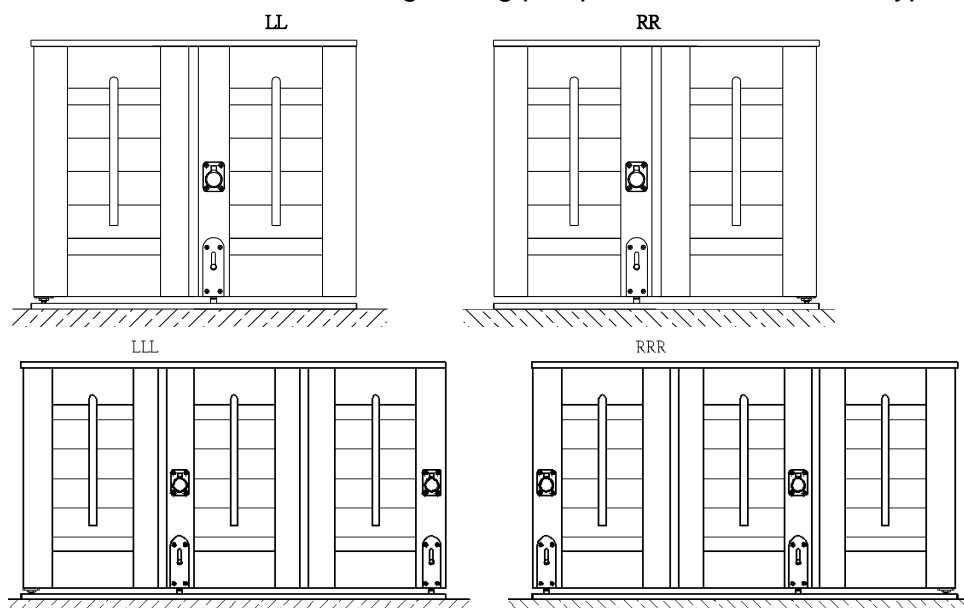

# NORMAN® ULTRA

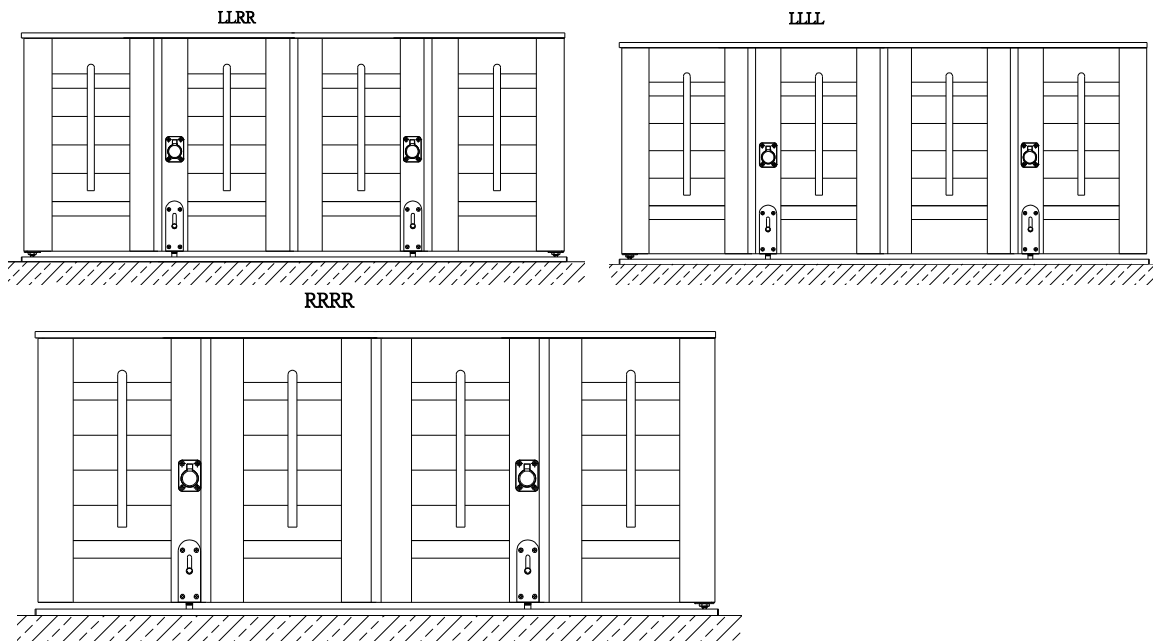

## Bottom Pivot Bracket for 90 degree bifold:

For 90° Bifold Track Shutter, there will be 2 types of Bottom Pivot Brackets available.

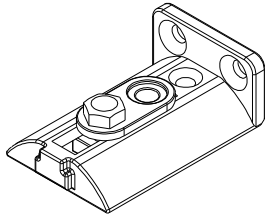

For Inside Mount, Bottom Pivot L Bracket will be supplied as default;

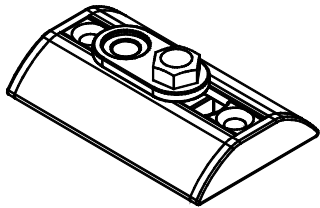

For Semi-Inside or Outside Mount, bottom pivot bracket will be supplied as default.

For 180° Bifold Track Shutter, 81mm Bottom Pivot L Bracket will be supplied as default.

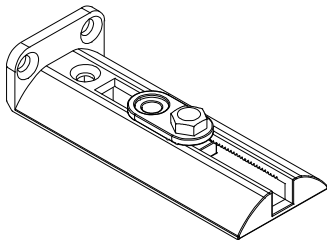

**Track Dimension:**

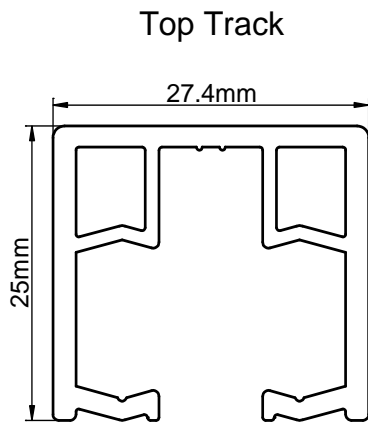

**Extra Magnets will be supplied for Bifold hinges: (only for the most top and bottom hinges)**

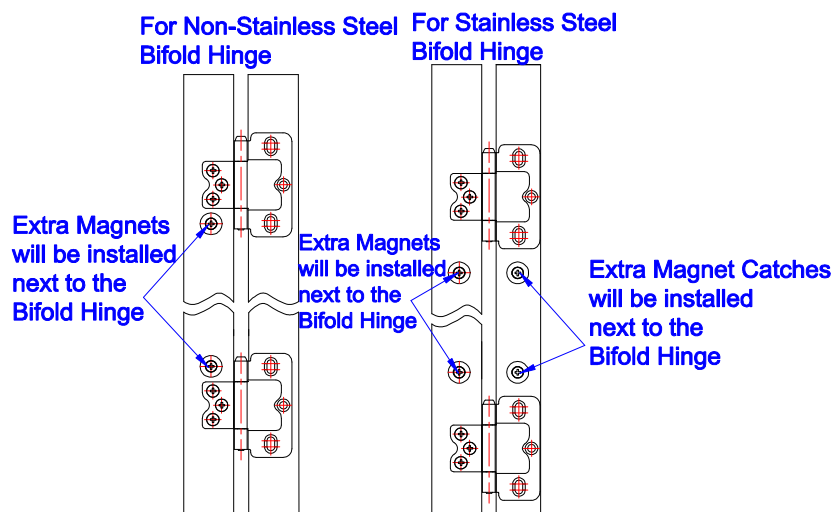

**Side Magnet:** applied to the meeting stiles of LR panels

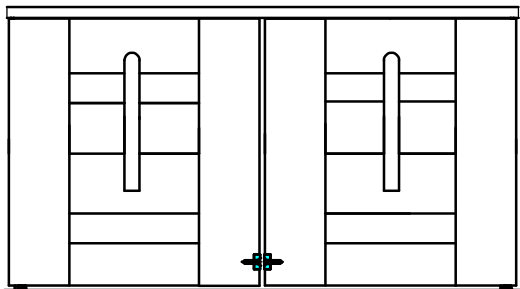

## Extra magnet and Side Magnet:



## 90° Bi Fold Track Shutters Hardware Box

Parts
Wrench
Hinge Pin
Support L Bracket (based on the length of header)
2 ½ " screws for support L bracket
¾ " screws for support L bracket
Bottom Pivot Bracket
38.1mm screws for bottom pivot bracket
63.5mm screws for Frame with pre-drilled screw holes

### Notes:

1. for all bifold track shutter Outside Mount, the header will be pre-drilled with screw holes in the insert and screws will be supplied by default;
2. for all bifold track shutter Inside/Semi-Inside Mount, the header will be pre-drilled with holes for screws and wood plug and screws and wood plug will be supplied by default

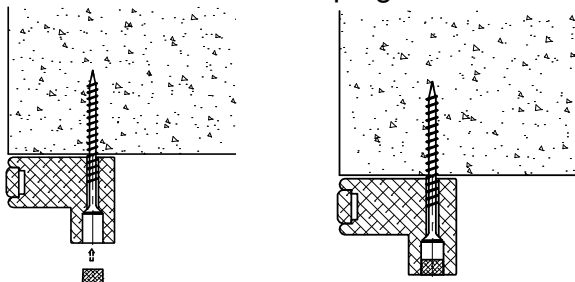

**90 Degree Bifold Track & Floating Panels Hanger Location:**

LL/RR/LLRR

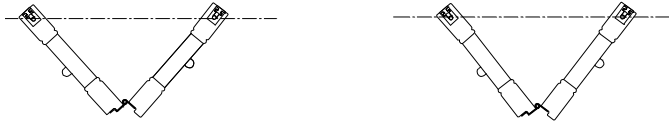

LLL/RRR/LLLRRR



LLLL/RRRR/LLLLRRRR



**180 Degree Bifold Track Panel Hanger Location:**

LL/RR/LLRR

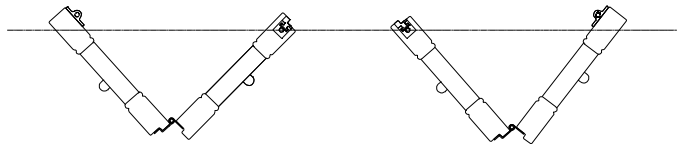

LLL/RRR/LLLRRR

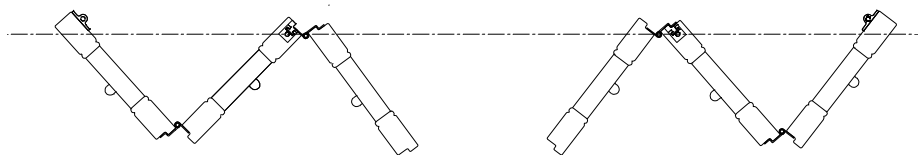

**Frame Hinged Bifold Track Panel Hanger Location:**

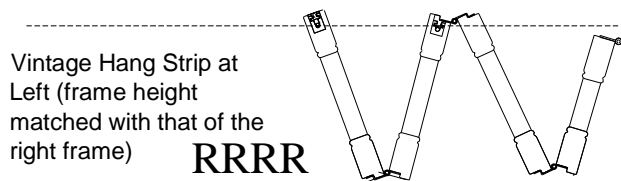
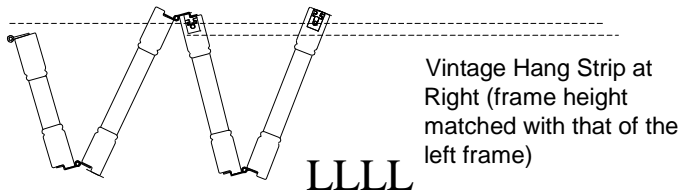
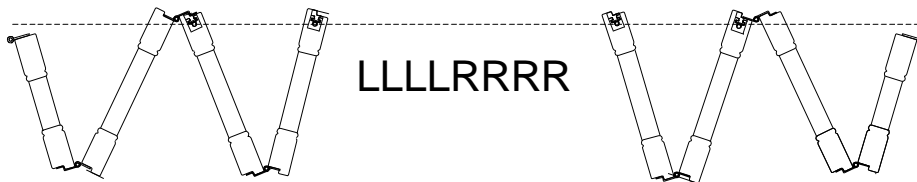
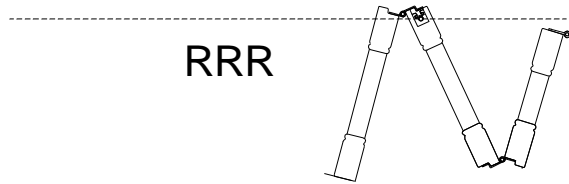
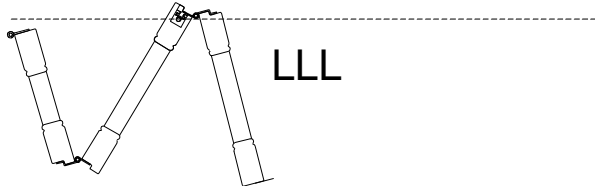
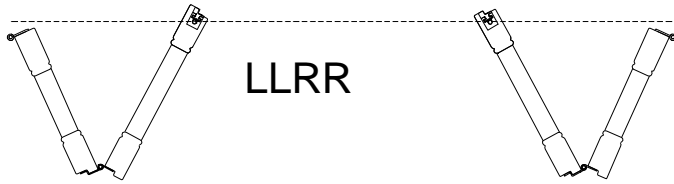
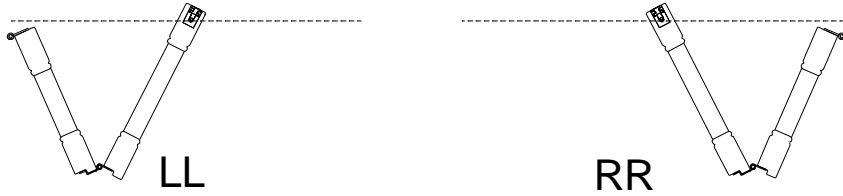



### Keystone for Fascia of the Track Shutter

When fascia length exceeds the limitation and needs to split, keystone design fascia will be supplied without surcharge for track shutters.

For fascia length within the split limitation, keystone can also be supplied as an option with surcharge.

For Deco Fascia:

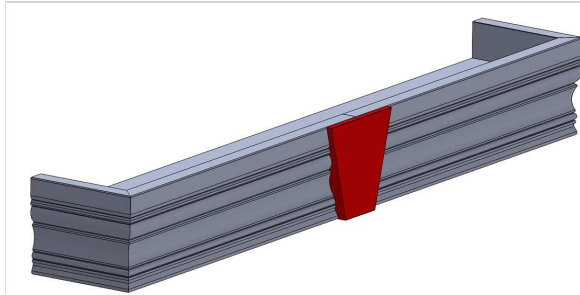

For Flat Fascia:

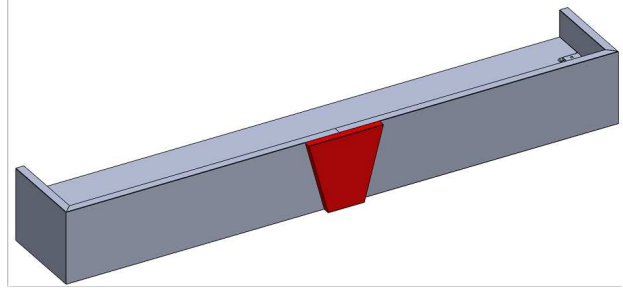

The keystone will be installed by screws. We will pre-drill the screw holes and the screws will be packed in hardware box.

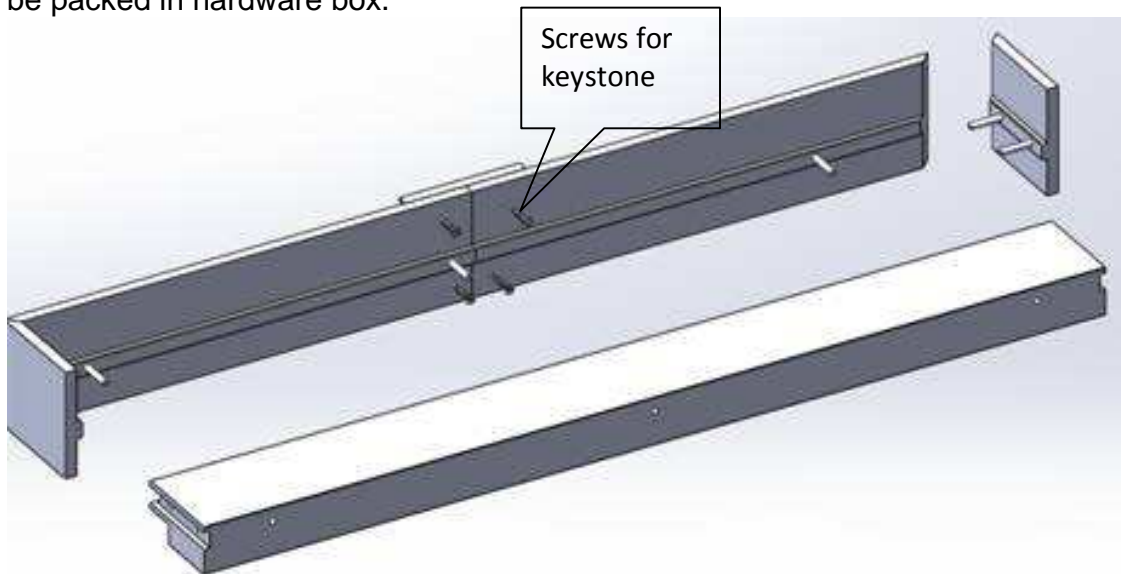

# Track Shutters—Bypass

NORMAN® ULTRA

## Guidelines and Specs:

Description	Minimum	Maximum		
		1 <sup>7</sup> / <sub>8</sub> "	2 <sup>1</sup> / <sub>2</sub> " ; 3"	3 <sup>1</sup> / <sub>2</sub> " ; 4 <sup>1</sup> / <sub>2</sub> "
Single-Panel Width (Wood)	6" (2" Stile) / 6.5" (2.25" Stile)	30"	36"	48"
Single-Panel Height	12"	144"	144"	144"

### Outside Mount

Max frame-to-frame width: window width + 3"

Max frame-to-frame height: window height + 4<sup>1</sup>/<sub>2</sub>"

### Semi-Inside Mount

Max frame-to-frame width: window width - 1<sup>1</sup>/<sub>8</sub>"

Max frame-to-frame height: window height + 1<sup>3</sup>/<sub>8</sub>"

### Inside Mount

Max frame-to-frame width: window width - 1<sup>1</sup>/<sub>8</sub>"

Max frame-to-frame height: window height - 1<sup>1</sup>/<sub>8</sub>"

### Carriers are in the Track / Hangers are in the Panel:

Adjustments to panel alignment are made by turning the Carrier Bolt with the wrench included in the Hardware Box

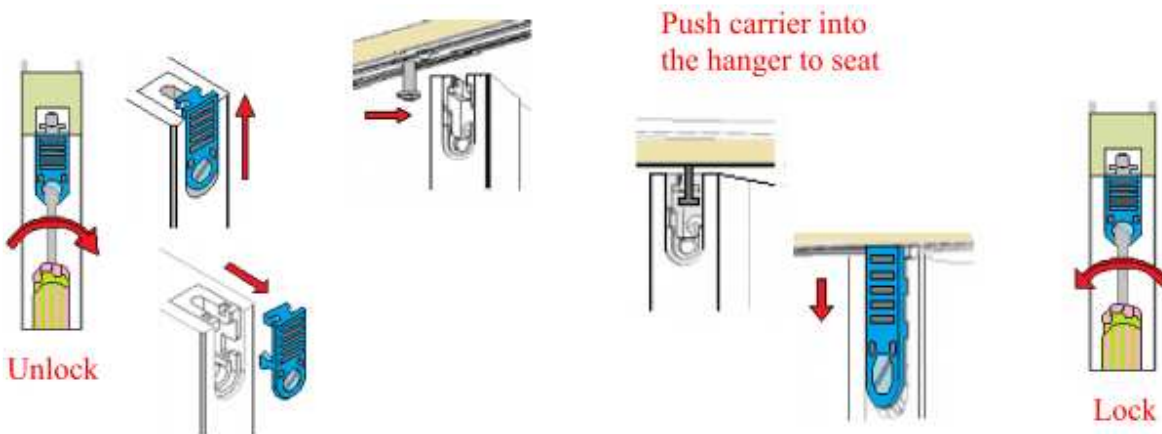

# Track Shutters—Bypass

NORMAN® ULTRA

## Top View

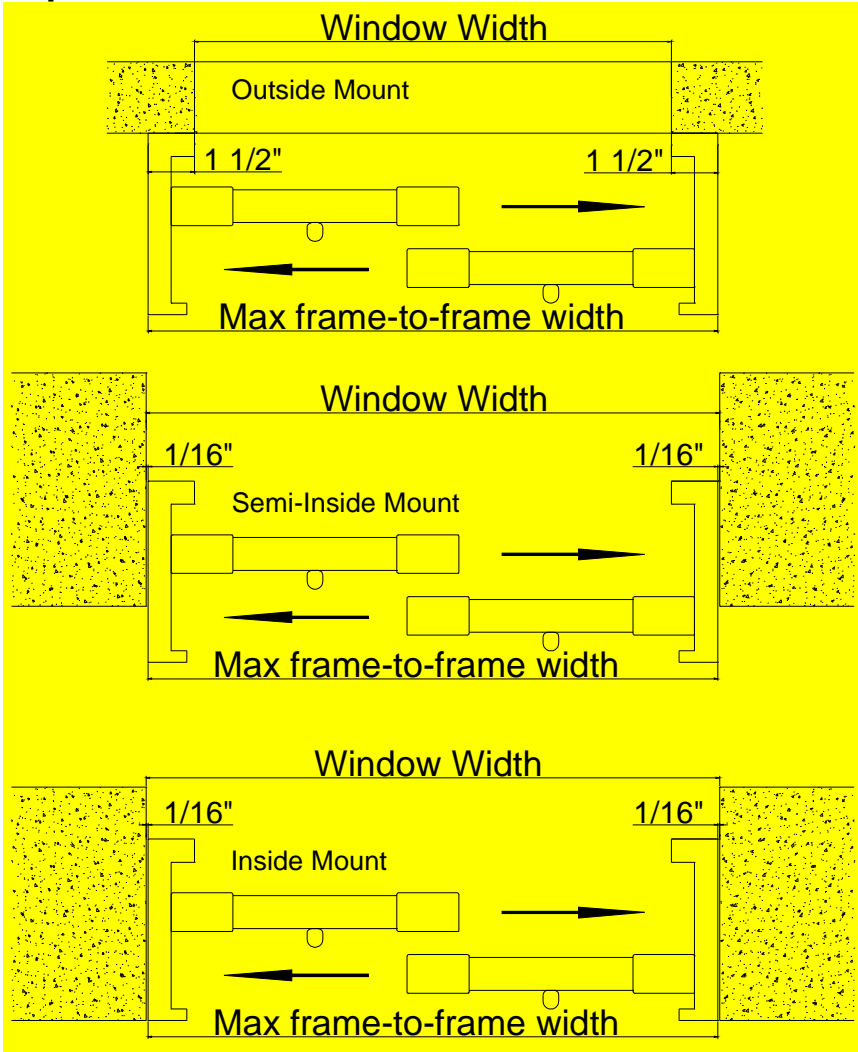

## Size Definition

For Semi-IM/OM Without Sideboards

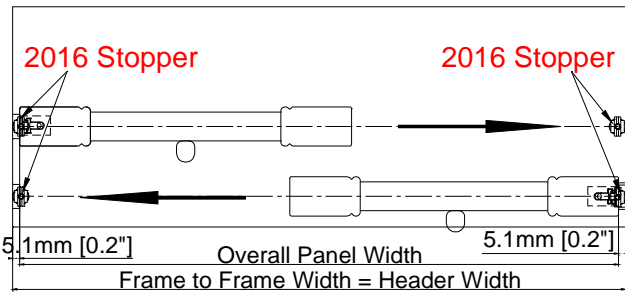

For IM Without Sideboards

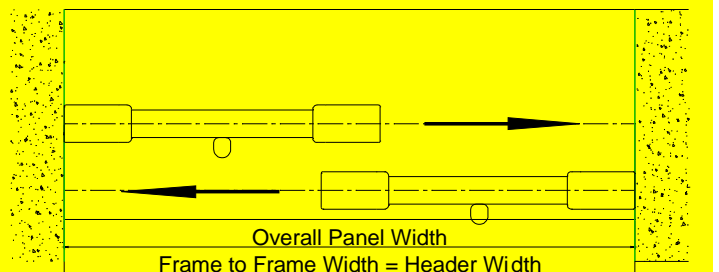

Note: For Semi-Inside/OM bypass without side boards, 2016 Stopper will be supplied.

# Track Shutters—Bypass

NORMAN® ULTRA

## Top View

3 Panel Center Open-Front

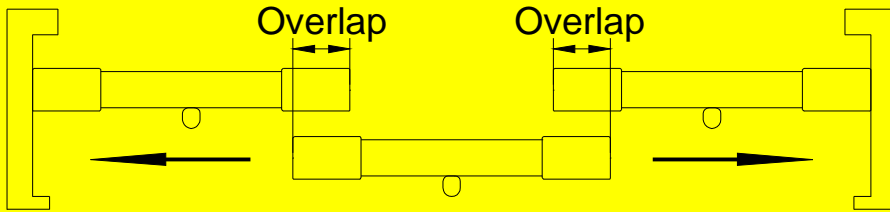

3 Panel Center Open-Back

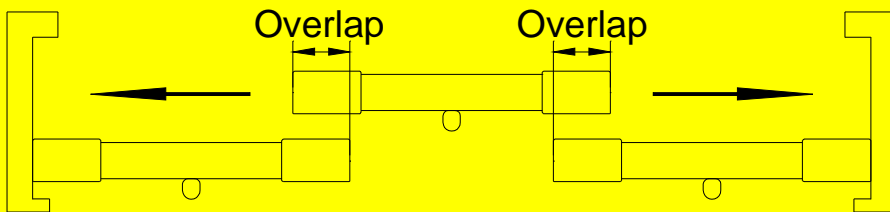

4 Panel Center Open-Front

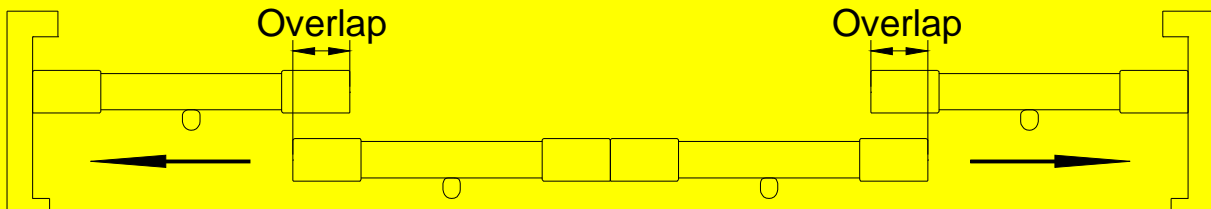

4 Panel Center Open-Back

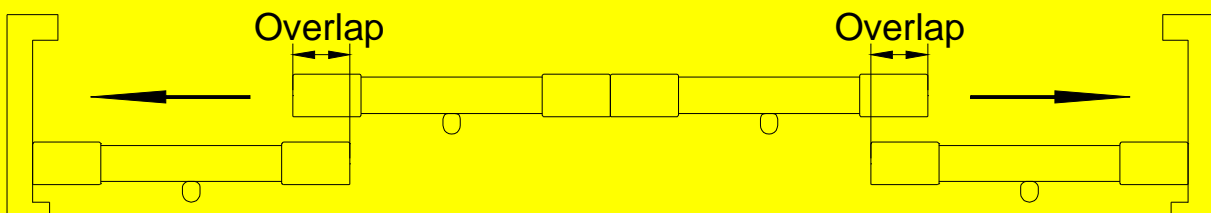

Note: Combined Joint panels are not available.

Three tracks are not available.

# Track Shutters—Bypass

NORMAN® ULTRA

## Mounting Options (Closed Bypass)

### Side View

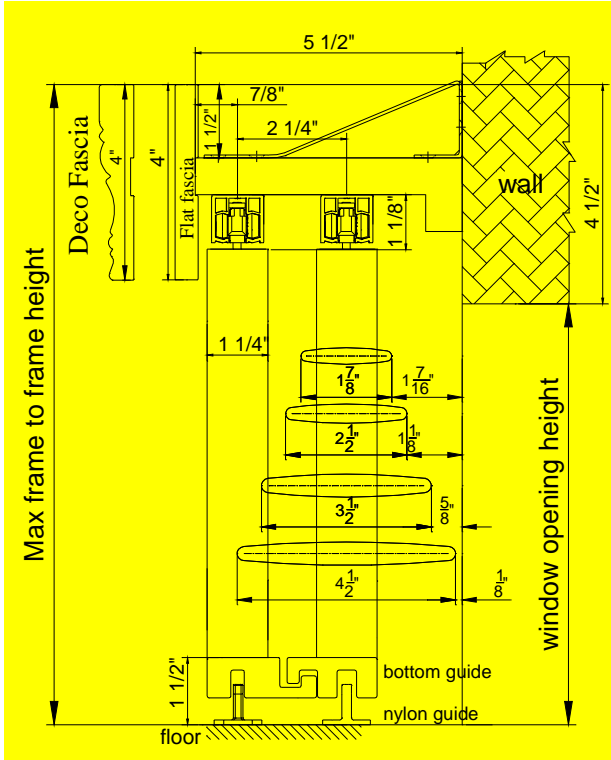

### Bottom Guide

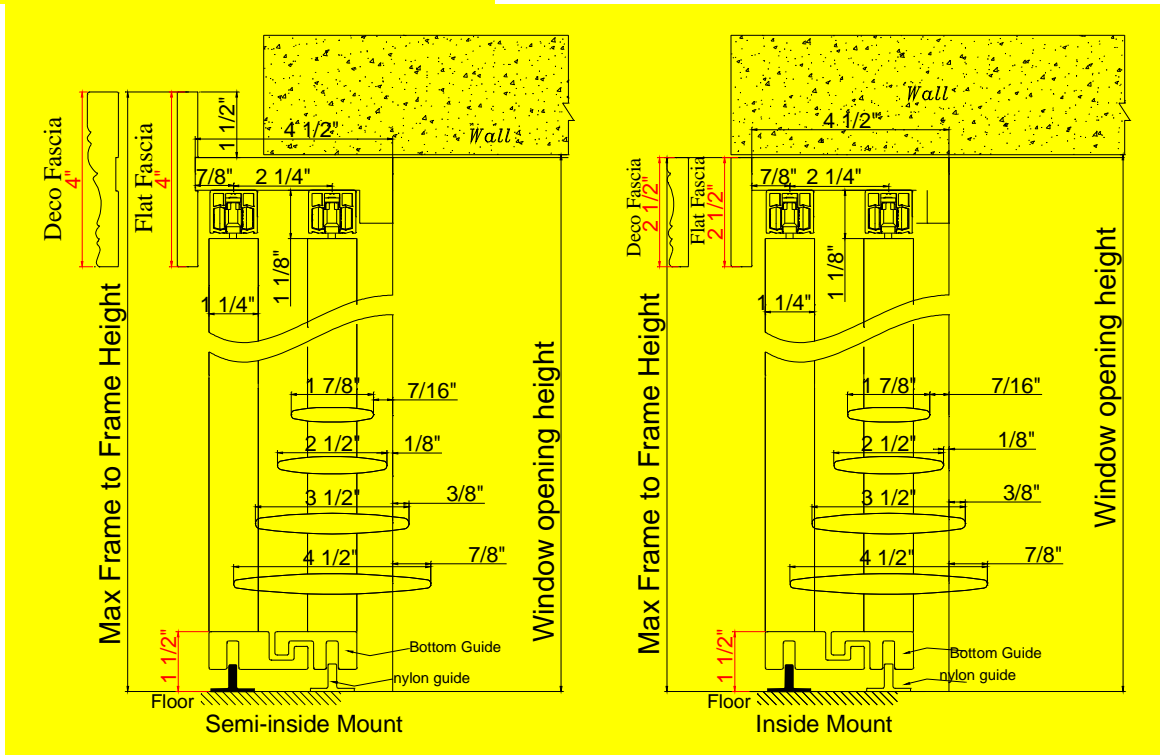
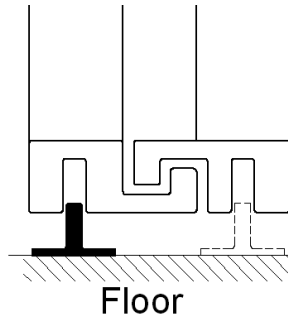

# Track Shutters—Bypass

NORMAN® ULTRA

## Mounting Options (Opened Bypass)

Only available in 2 1/2", 3" and 3 1/2" louver sizes

### 2 1/2" Louver

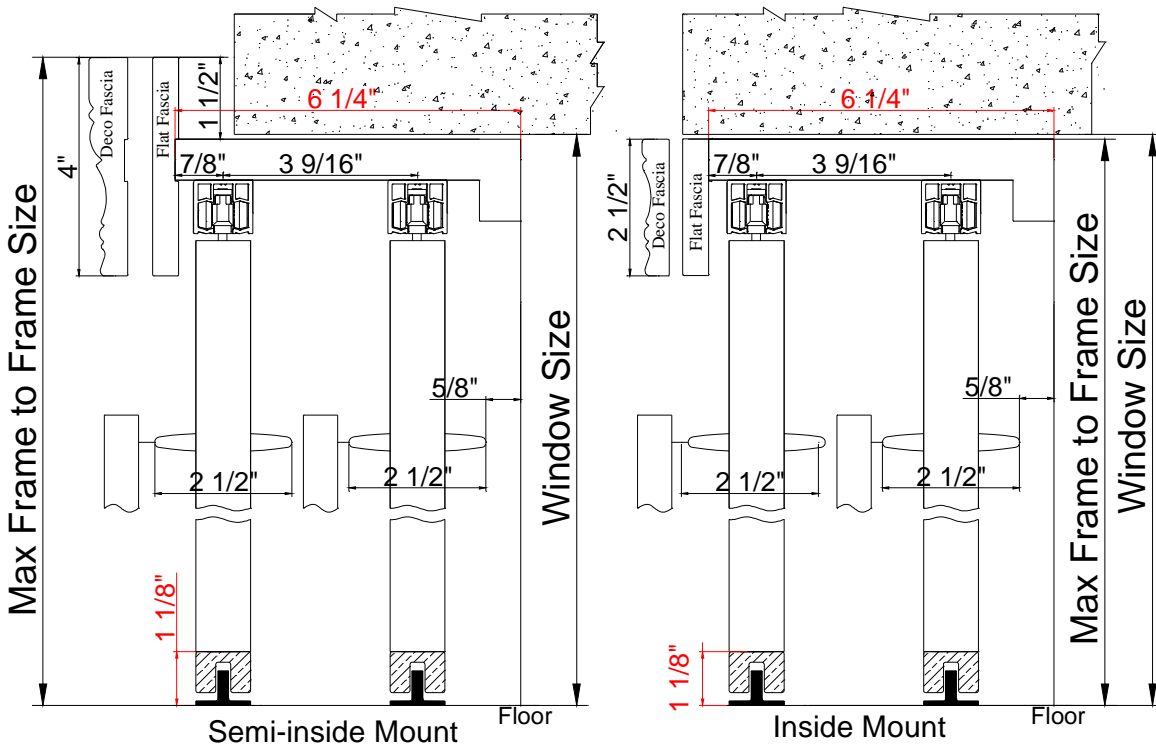
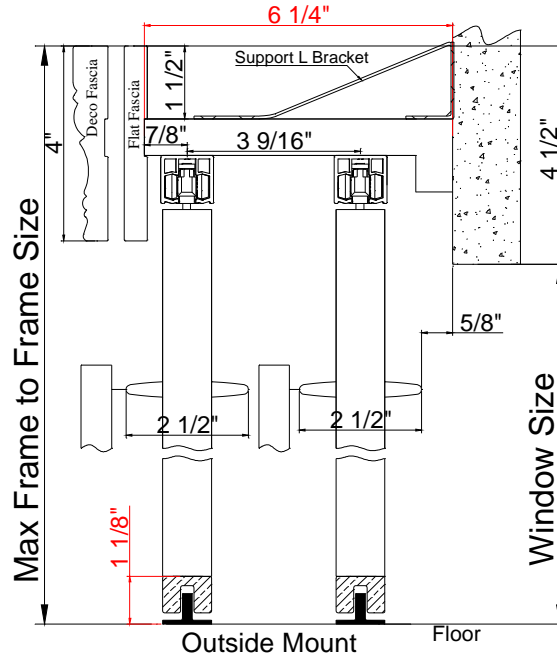

# Track Shutters—Bypass

NORMAN® ULTRA

**3" / 3 1/2" Louver**

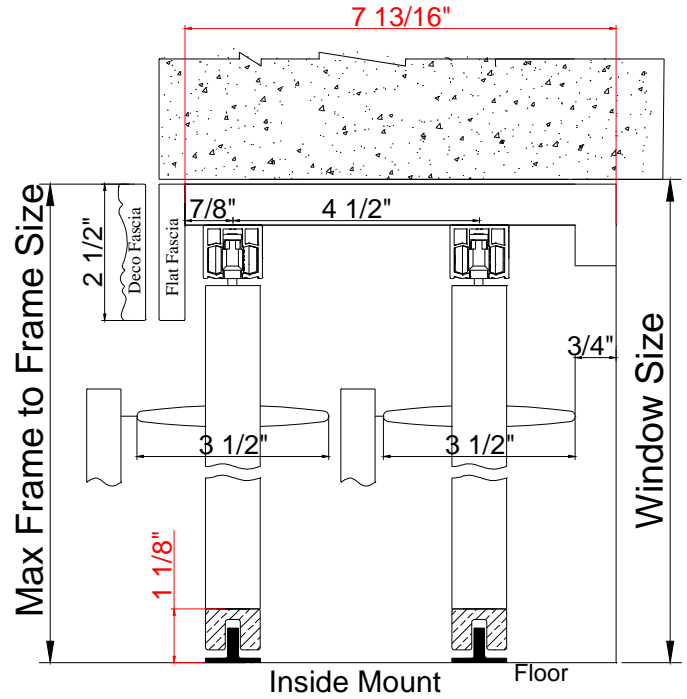
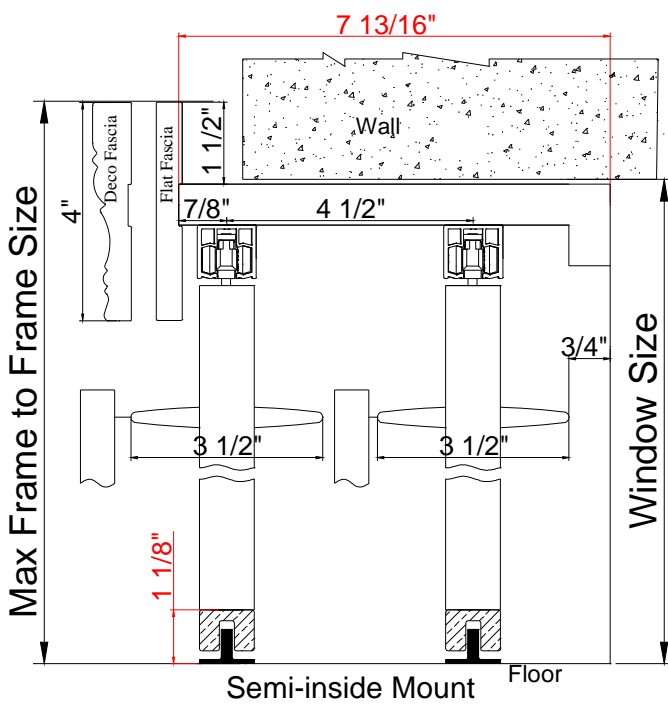
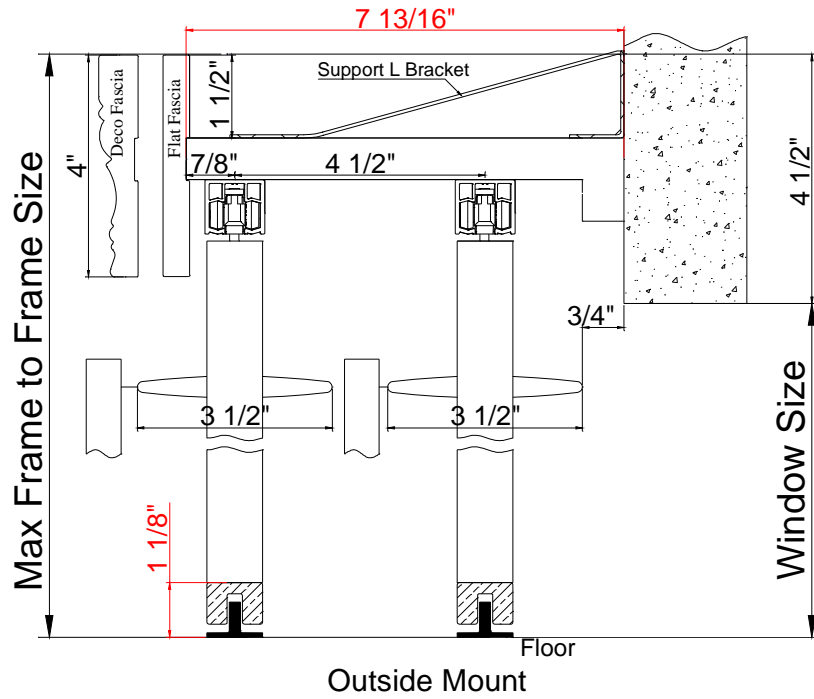

# Track Shutters—Bypass

NORMAN® ULTRA

Open By Pass: has 2 kinds of bottom guide

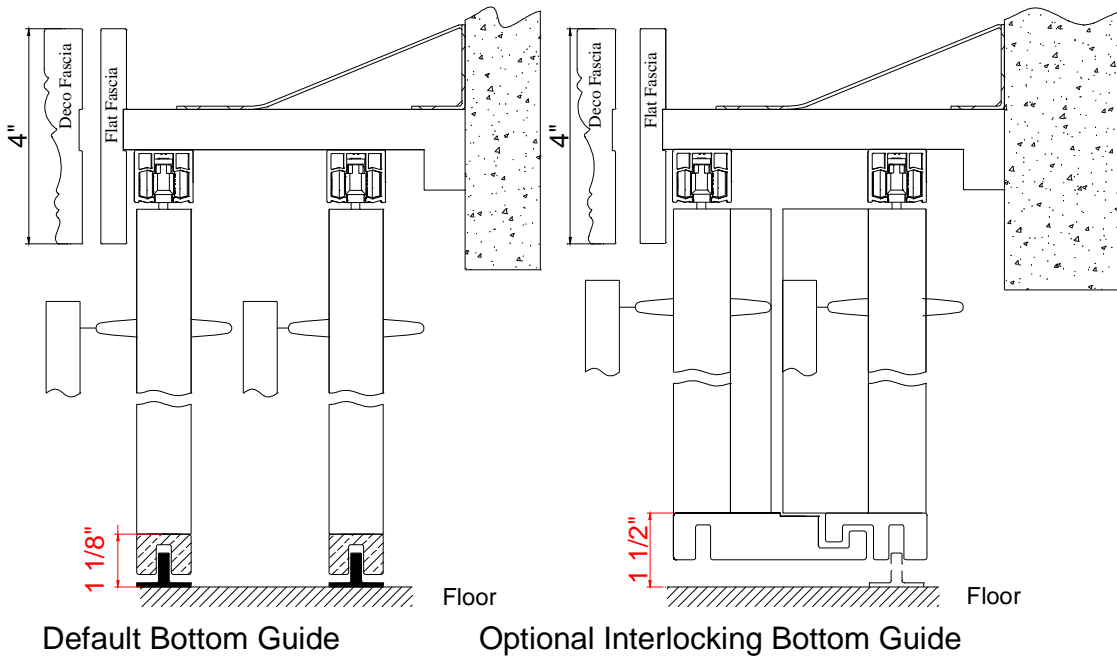

## Opened Bypass

### Top View

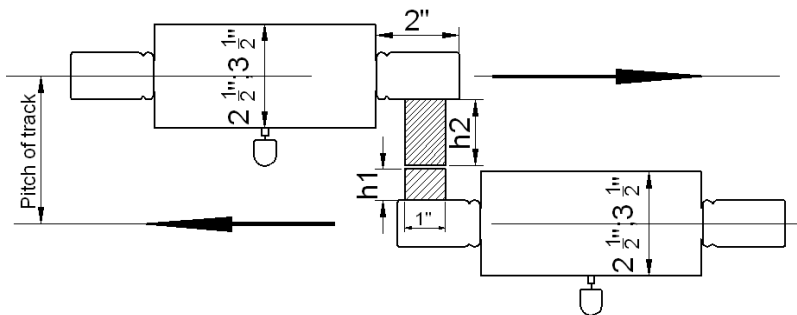

Note: The light block for open bypass will be changed to use screws with wood plugs instead of current dowels.

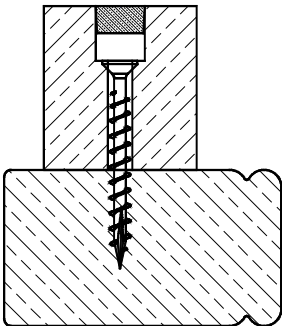



# Track Shutters—Bypass

NORMAN® ULTRA

## Separation of track

Louver	U shape bottom guide		Interlocking bottom guide	
	Regular Tilt Rod	Invisible tilt	Regular Tilt Rod	Invisible tilt
2.5"	3 9/16"	2 5/8"	3 9/16"	3 9/16"
3" / 3.5"	4 1/2"	3 15/16"	4 1/2"	4 1/2"

## Light block thickness for panel

Louver		U shape bottom guide		Interlocking bottom guide	
		Regular Tilt Rod	Invisible tilt	Regular Tilt Rod	Invisible tilt
2.5"	h1	9/16"	9/16"	9/16"	9/16"
	h2	1 9/16"	9/16"	1 9/16"	1 9/16"
3" / 3.5"	h1	1"	1 3/16"	1"	1"
	h2	1 15/16"	1 3/16"	1 15/16"	1 15/16"

**Nylon Guide:** The nylon guide is composed by 2 parts and will supplied as a whole set by default (bottom part 16mm and top part 5mm), please remove the top part if necessary.

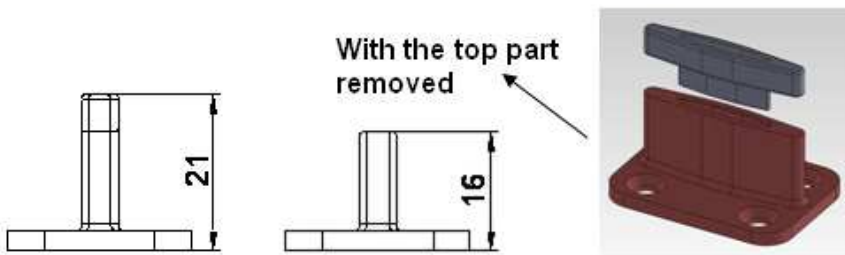

## The 2016 Stopper

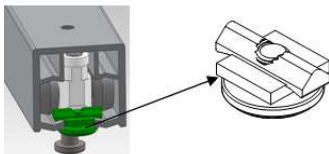

For outside mount/semi-inside mount bypass without side boards, the 2016 Stopper will be supplied by default. The gap between the fascia return / end of top track and the panel is 5mm each side. The 2016 stopper can also be used in the center or any position of the top track as an option. Please see drawing below to show the gap.

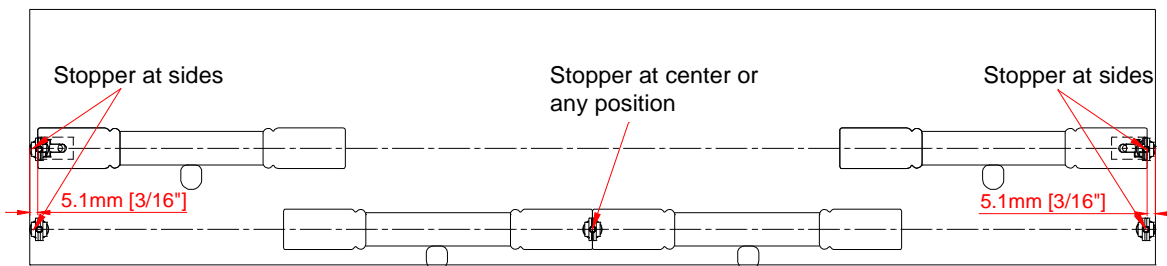

# Track Shutters—Bypass

NORMAN® ULTRA

## Track Shutters Framing Materials

Framing	Size				Pc(s)
<b>L Shape Header</b>	<b>Header (Closed Bypass)</b>	<b>Header (Opened Bypass)</b>	<b>Supporting Strip</b>		1 pc
<b>(2 in 1)</b>	$\frac{3}{4}" \times 5\frac{1}{2}"^*$ (Default for Outside Mount; Optional for Semi-Inside and Inside Mount)	$\frac{3}{4}" \times 6\frac{1}{4}"^*$ ( $2\frac{1}{2}"$ Louver)	$\frac{3}{4}" \times \frac{3}{4}"$		
Header with Supporting Strip	$\frac{3}{4}" \times 4\frac{1}{2}"^*$ (Default for Semi-Inside and Inside Mount; Optional for Outside Mount)	$\frac{3}{4}" \times 7\frac{13}{16}"^*$ ( $3\frac{1}{2}"$ Louver)			
	Custom * $\leq 8"$	Custom * $\leq 8"$			
<b>U Shape Side Frame</b>	<b>Side Frame (Closed Bypass)</b>	<b>Side Frame (Opened Bypass)</b>	<b>Supporting Strip</b>	<b>Side Fascia</b>	2 pcs
<b>(3 in 1)</b>	$\frac{3}{4}" \times 5\frac{7}{8}"^*$ (Default for Outside Mount; Optional for Semi-Inside and Inside Mount)	$\frac{3}{4}" \times 6\frac{5}{8}"^*$ ( $2\frac{1}{2}"$ Louver)	$\frac{3}{4}" \times \frac{3}{4}"$	$\frac{3}{8}" \times 1\frac{1}{4}"$	
Side Frame with Supporting Strip & Side Fascia	$\frac{3}{4}" \times 4\frac{7}{8}"^*$ (Default for Semi-Inside and Inside Mount; Optional for Outside Mount)	$\frac{3}{4}" \times 8\frac{1}{4}"^*$ ( $3\frac{1}{2}"$ Louver)			
	Custom * $\leq 8"$	Custom * $\leq 8"$			
Top Fascia (Plain/Deco)	4" (Semi-inside and Outside Mount)				1 pc
	$\frac{1}{2}" \times 2\frac{1}{2}"$ (Inside Mount)				
Top Fascia Return	4" (Semi-inside and Outside Mount)				2 pcs
	N/A (Inside Mount)				

**Note:**

- When the header size is  $4\frac{1}{2}"^*$ ,  $5\frac{1}{2}"^*$ ,  $6\frac{1}{4}"^*$  or  $7\frac{13}{16}"^*$ , the L Shape header and the U Shape Side Frame will be sent integrally. That is:
  1. The header and the supporting strip will be sent integrally as L Shape Header;
  2. The side frame, supporting strip and the side fascia will be sent integrally as U Shape Side Frame.
- For any custom header sizes other than  $4\frac{1}{2}"^*$ ,  $5\frac{1}{2}"^*$ ,  $6\frac{1}{4}"^*$  or  $7\frac{13}{16}"^*$ , the L Shape Header and the U Shape Side Frame will be sent separately. That is:
  1. The header and the supporting strip will be sent separately for L Shape Header;
  2. The side frame, supporting strip and the side fascia will be sent separately for U Shape Side Frame.

# Track Shutters—Bypass

NORMAN® ULTRA

## Hardware Box

Hardware Box
<b>Part</b>
Wrench
Nylon Guide
$\frac{3}{4}$ " screws for Nylon Guide
Support L Bracket (based on the length of header)
2 $\frac{1}{2}$ " screws for support L bracket
$\frac{3}{4}$ " screws for support L bracket

### Keystone for Fascia of the Track Shutter

When fascia length exceeds the limitation and needs to split, keystone design fascia will be supplied without surcharge for track shutters.

For fascia length within the split limitation, keystone can also be supplied as an option with surcharge.

For Deco Fascia:

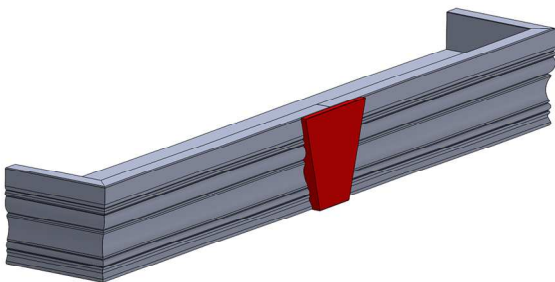

For Plain Fascia:

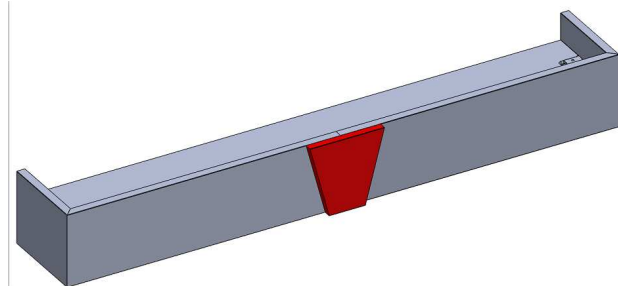

The keystone will be installed by screws. We will pre-drill the screw holes and the screws will be packed in hardware box.

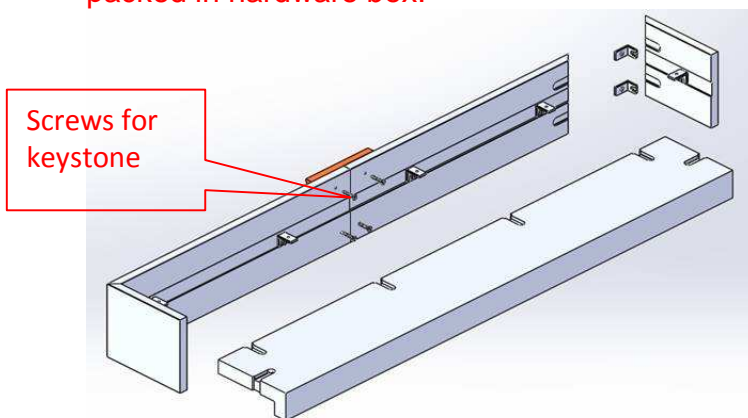

# Track Shutters—Bypass

NORMAN® ULTRA

## Plastic L Bracket to Connect the Header, Fascia & Fascia Returns



L Bracket will be used to connect the header, fascia and fascia returns for Bypass shutter. This applies for Inside Mount, Semi-Inside Mount & Outside Mount.

### OM & Semi-IM

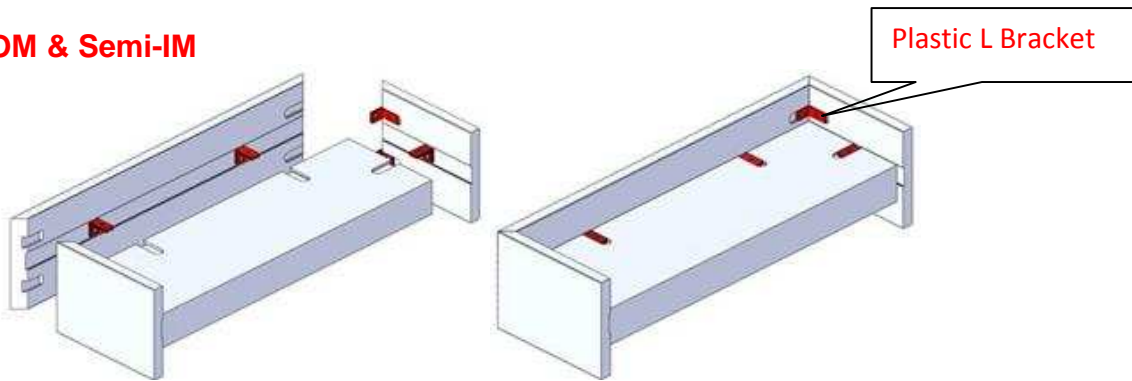

### IM

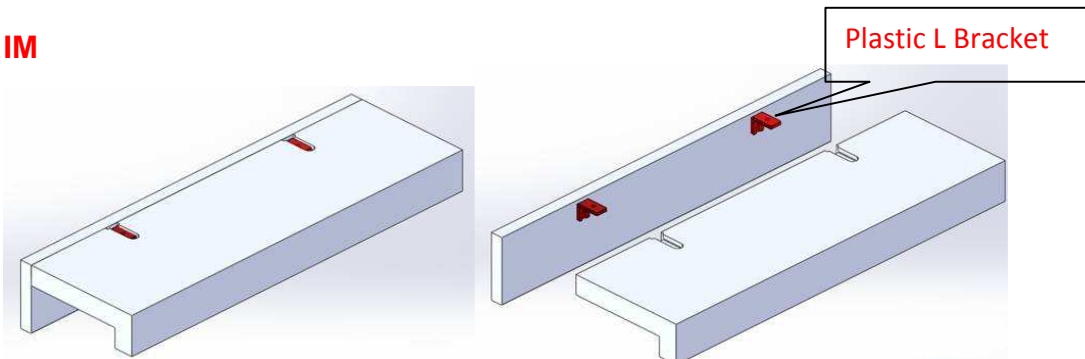

# Special Options

## Café Shutters\*

- The top of the panel requires a special finish. Please indicate “café shutter” when placing orders.
- The shutter does not come with recessed magnet on top.
- **When the height of the framing material (including t-posts) exceeds the panel height, by more than 5", a surcharge will apply.**

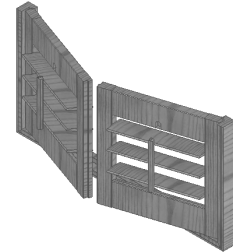
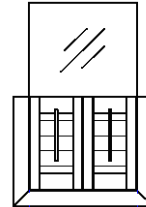

## Double-Hung Shutters\*

- For total number of panels, please include panels in both rows.
- For panel configuration, please provide panel fold for one row.
- The default location for the division point is the center unless specified otherwise.
- Horizontal T Post\* can be added for increased structural integrity.
- Warranty needs to be waived for the horizontal T post length exceeds 48".

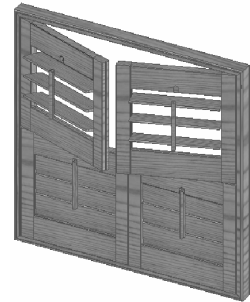
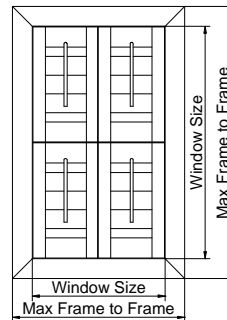

## Fixed Louvers

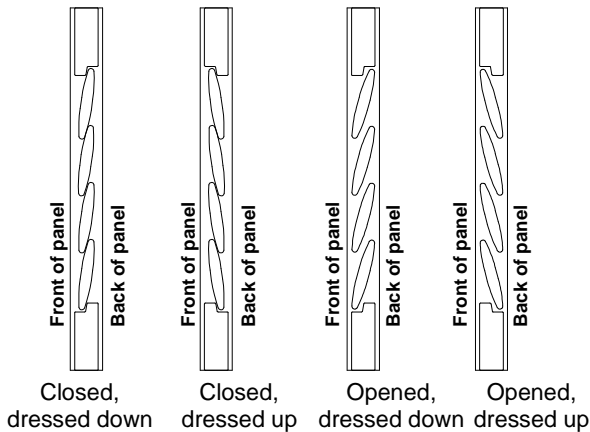
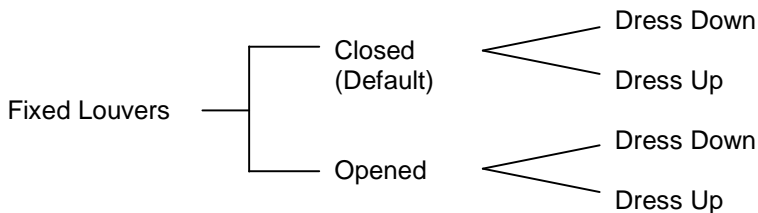

\*Some surcharges apply

## Special Options (continued)

### Raised Panel \*

Available in

- Raised panel with louver combination.
- Raised panel only.

Specifications

- $12'' \leq$  raised panel section height  $\leq 48''$ .
- For other louver sizes, divider rail is required for panel heights over 84".
- The maximum panel height is 144".

Raised Panel Location(s)

- Top.
- Middle.
- Bottom.
- All (if panel height does not exceed 48").

Rails

- For a panel with raised panel section only, 3" is the standard size for top, bottom and divider rails.
- The minimum size for top and bottom rails is 3".
- If you are matching raised panels to standard shutter panels, the top rail of the standard shutter panel will match the top rail of the raised panel. Please specify clearly when placing order.

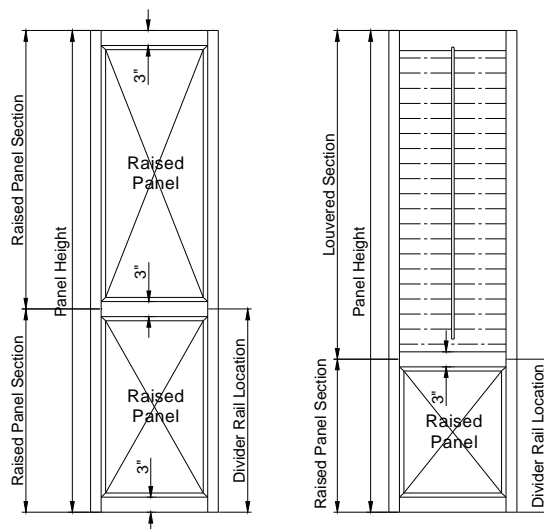

\*Some surcharges apply

## Special Options (continued)

### Hand-Carved Rail \*

- Available for top and/or bottom rails.
- Please note that the proportion of the design is based on the height of the rail, not the width of the panel.



Vine



Wheat



Rosette



Star



Fish



Swan



Fleur de Lis

## Special Options (continued)

### Liberty Arch \*

- The arch starts and ends 1" from the rail sides.
- The arch height is half of the top rail size (rounded up to  $\frac{1}{8}$ " increment).
- The shape of the Arch is based on 3 points taken from the rail.
  - 1<sup>st</sup> point: 1" from the left stile
  - 2<sup>nd</sup> point: 1" from the right stile
  - 3<sup>rd</sup> point: Midpoint of the rail front

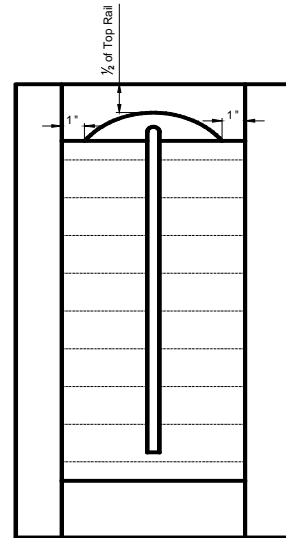

### French Door Contour Collection \*

- Flush and offset cutout options are available in both curved and square French door cutout.
  - ◊ Offset cutout is good option for French Door with molding around the glass.
- All French door cutouts are only available in L frame.
- For measurement details please refer to Form section.
- French Door cutouts with Arch/Quarter Arch at the top are also available.

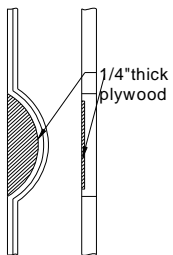

Type A

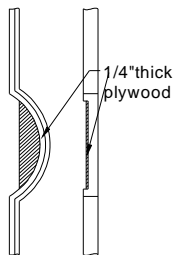

Type B

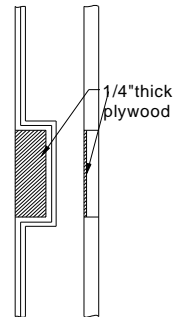

Type C

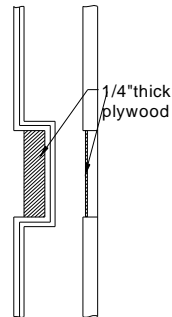

Type D

\*Some surcharges apply



## Special Options (continued)

### Custom Colors \*

Available in Norman® Ultra shutters.

Option (Color Code)	Sample Size	<u>Confirmation Process</u>
<b>Custom Solid (C01)</b>	At least 4" x 4" on a clean, flat surface such as wood or cardboard (please do not send anything critical as the sample will not be returned)	All orders require customer's confirmation via <b>digital photo OR actual swatch</b> in the mail before production. An additional shipping and handling fee applies.
<b>Custom Stain (C02)</b>		

Note:

- 1) All custom colors will be finished with the standard gloss used on all Norman products.
- 2) Please be aware that we will only be able to match the tone and not the texture or finish of the sample you submit.
- 3) Only one color revision will be allowed during the color confirmation process.
- 4) Customer may shorten the production lead-time by opting to waive the color confirmation process or by approving a digital photo. Norman will not be responsible for any color variation on waived confirmations or approved digital photos.

Disclaimer:

Sherwin Williams ColorSnap (MWCS),  
 Sherwin Williams Designer Expressions (MWDE),  
 Benjamin Moore Classic (MBMC) (M2460009TL) &  
 Benjamin Moore Preview (MBMP) (M2440564TL)

**Benjamin Moore, Off White Collection M2451888TL**

are registered trademarks or trademarks of their respective owners. All other trademarks mentioned herein are the property of Norman International, Inc. and/or its affiliates in the U.S. and certain other countries. Reference herein to the commercial products or service of others by trade name, trademark, manufacturer, or otherwise, does not necessarily constitute or imply its endorsement.

## **Auto Tilt™ (Patented) \***

- Available in Bifold or Multi-fold panel configuration
- Available with Invisible Tilt Only
- Available in 2" Butt and Rabbet Stile
- Minimum Louver Qty (Please see below for details)
- Ring pulls included. For ring pull location, please refer to the ring pull section.

When there is only one louver section (no divider rail/no split tilt)

Louver Size	Rail Size	Minimum Louver qty
2.5"	<4.25"	6
	>=4.25"	4
3"	<3.75"	5
	>=3.75"	4
3.5"	2.75"~6.5"	4
4.5"	2.75"~6.5"	3

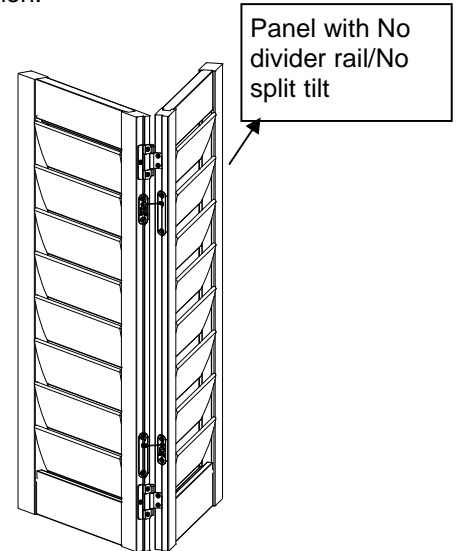

When there is more than one louver sections (with divider rail/ split tilt)

Louver Size	Rail Size	Minimum Louver qty
2.5"	<4.25"	5
	>=4.25"	4
3"	2.75" – 6"	4
3.5"	2.75"~6.5"	3
4.5"	2.75"~6.5"	3

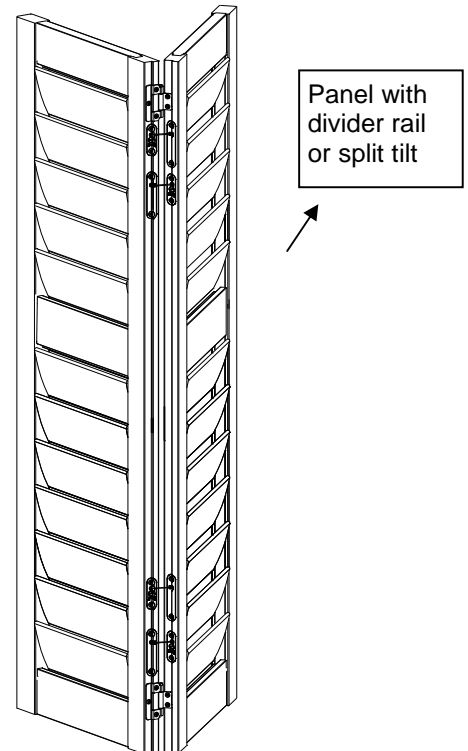

\*Some surcharges apply

**Standard frame cutouts:** R cutout, S cutout, L cutout, C cutout. The sizes can vary.

a. **R cutout**---Ridge cut out: 0.375"deep x 0.5"wide and 0.375"deep x 1.0" wide (see below). The cutout can be on the top and the bottom of the frame (available in all styles of the L-frames and all sill plates.)

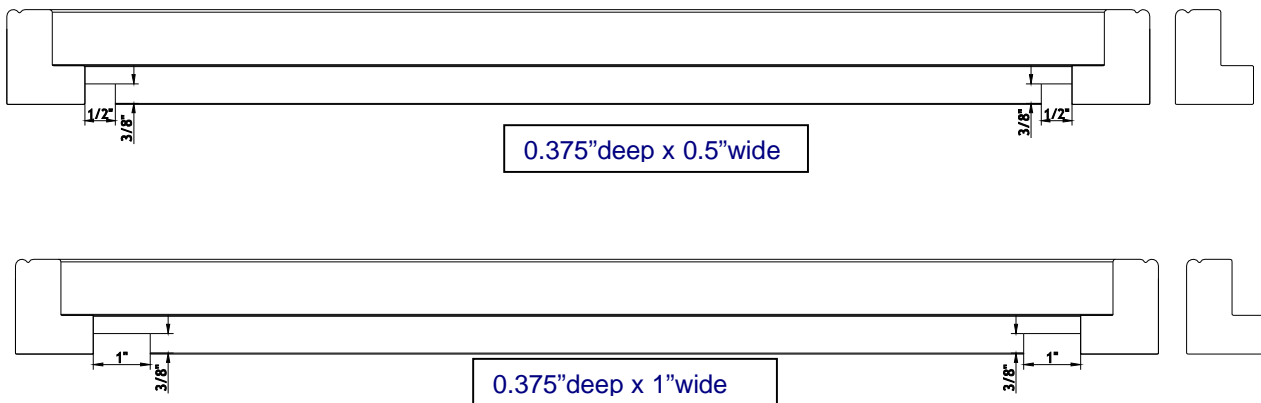

b. **S cutout**---Sill cut out: 0.375"deep x 1.25"wide. The cutout is always on bottom of bottom frame. Available in all styles of the L-frames and all sill plates.

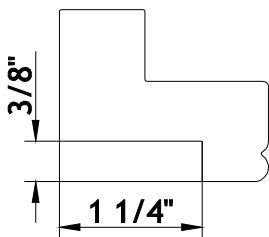

c. **L cutout**---Lock cutout.

There is a possibility of being one or two cutouts on the T-posts depending on the height of the window;

For window around 42-48" height, 1 cutout is available;

For window around 60" or above, 2 cutouts are available.

L cutout can also be needed on single panel windows on the non-hinge side, usually on a style of L-frame.

Measuring for L cut out: The default size is 5.125". Measurements are from the bottom of frame if size type is max frame to frame size and from bottom of window if it is window size to the center of the cut out (2.5625" down and 2.5625" up).

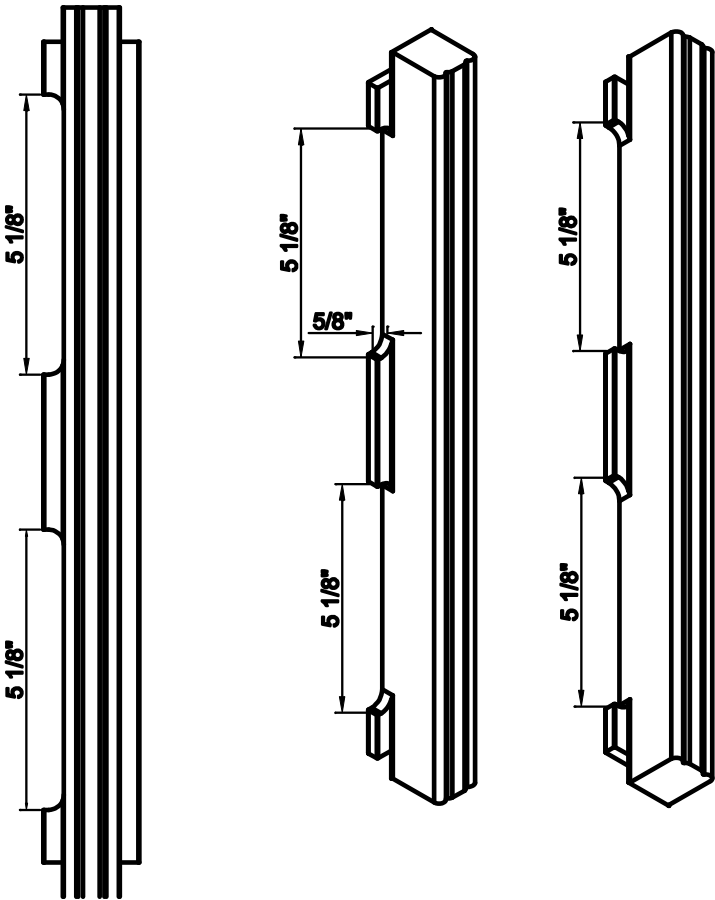

d. C cutout---Crank cut outs (C1 cutout, C2 cutout, C3 cutout): (Always on bottom of bottom frame. Available in all styles of the L-frames and all sill plates.)

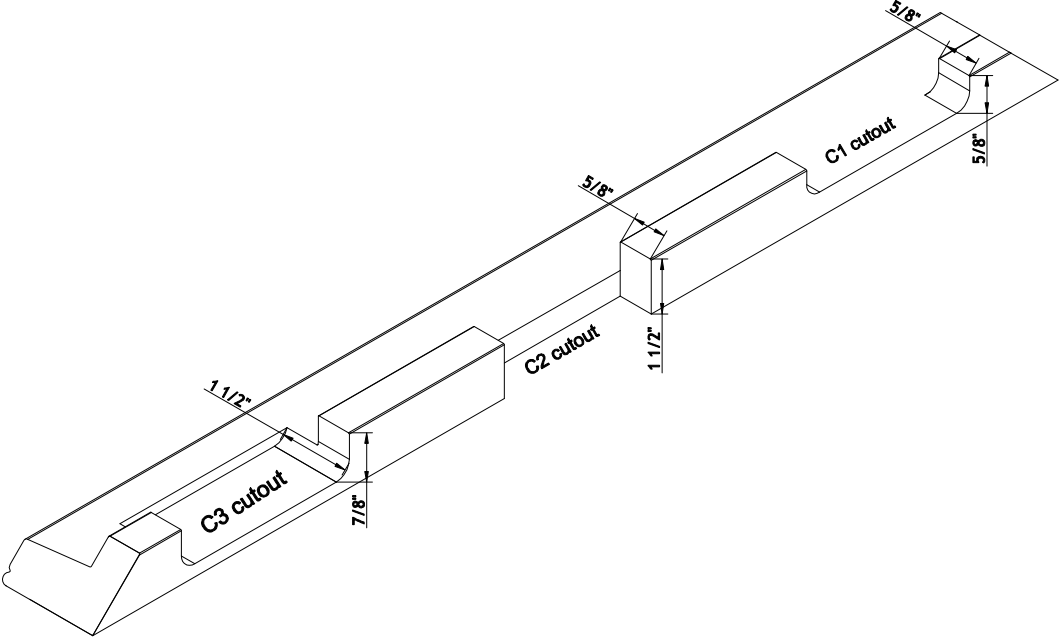

\*Some surcharges apply

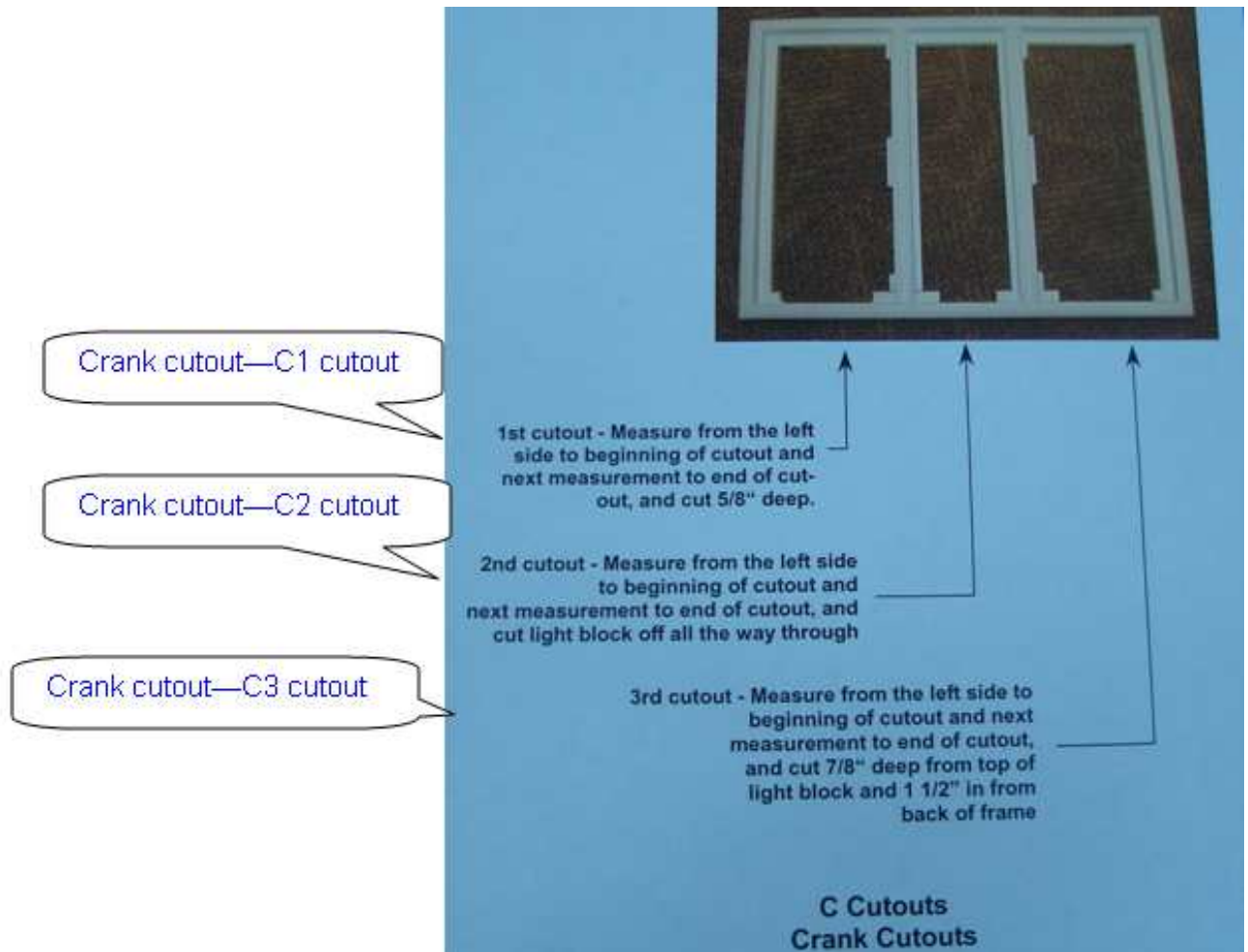

e. A & D cutouts: This should be for the outside mount frames, deco frames, L-frames. Normally a build out or an extension is used to build the frame out so the frame can set on top of the "keystone":

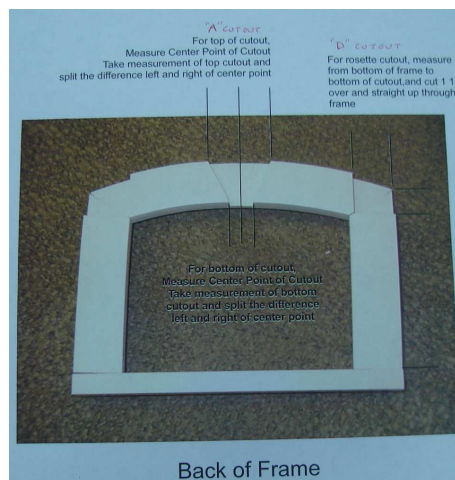

\*Some surcharges apply

# Specialties

## Specialty Shutters\*

Specialty shutters are made of premium solid wood, finished to match the beauty of all Norman shutters. Templates are required if it is an imperfect specialty. Delivery time is 8 weeks from the order confirmation date for all specialty shutters. Please refer to Specialties and Template Requirement sections for details.

Please note that Hinge sunburst at Top w/Divider Strip is not available for Ultra program.

**Regarding frame with an insert or solid frame issue:**

**1). For Half Round Sunburst, Quarter Round Sunburst, Eyebrow Sunburst & Elongated Eyebrow Sunburst:**

- All deco frames will be made as solid frames;
- All Vintage L frames & Vintage hang strip: all top frames (curve shape frame) will be made as a solid frame but the bottom & both sided frames (straight frames) will be made as regular frames with inserts

**2). For Triangle, Hexagon, Octagon, Peak & Angle top: all frames will be made as regular frames with inserts.**

**3). For Circle, Oval: all frames will be made as solid frames (not with an insert).**

**4). For Louver Arch with Eyebrow curve shape:**

- All deco frames excluding 2.5" Mission deco frame: all frames will be made as solid frames (not with an insert).
- All Vintage L frames & Vintage hang strip & 2.5" Mission deco frame: the top frame (curve shape frame) will be made as a solid frame but the bottom & both sided frames (straight frames) will be made as regular frames with inserts;

**5). For other Specialty Shutters when curve shape is similar as perfect arch (such as Louver Arch except Louver Arch with Eyebrow curve shape in point 4), Horizontal louvers center arch with quarter round side panels(-Standard louvered arch & Continuous arch), Sunburst louvers center arch with quarter round side panels, Arch Top Picture Window with horizontal louvers, Arch Top Picture Window with Sunburst, Standard unit with horizontal arch center etc.):**

- All deco frames will be made as solid frames;
- All Vintage L frames & Vintage hang strip: all top frames (curve shape frame) will be made as a solid frame but the bottom & both sided frames (straight frames) will be made as regular frames with inserts.

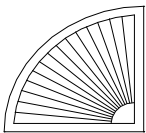

Quarter Round Sunburst

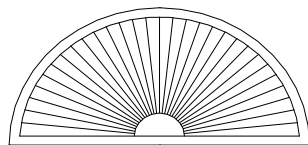

Half Round Sunburst

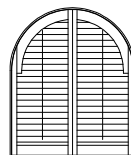

Louvered Arch w/ Center Tilt Rod

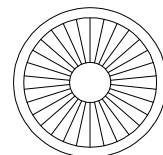

Circle Sunburst

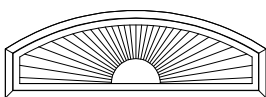

Elongated Eyebrow Sunburst

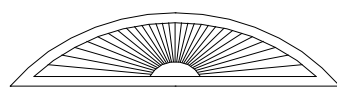

Eyebrow Sunburst

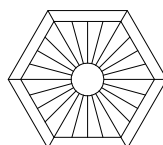

Hexagon Sunburst

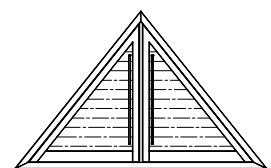

Triangle

\*Some surcharges apply

# NORMAN® ULTRA

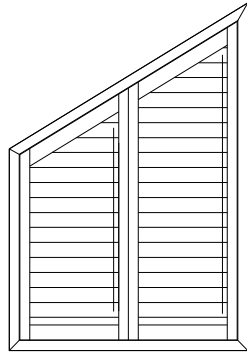

**Angle Top**

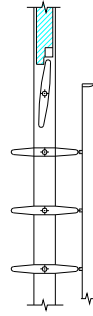

**\*Top louver of angle top  
might be fixed as shown**

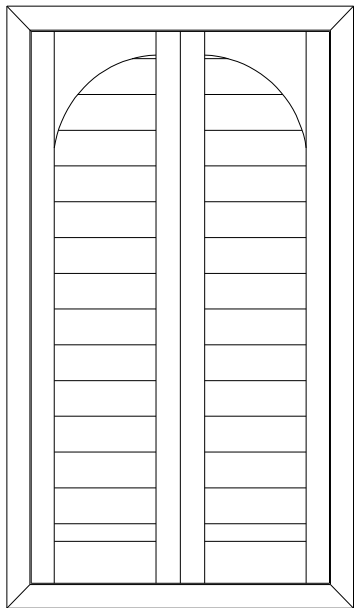

**Louver Arch in a Rectangle**

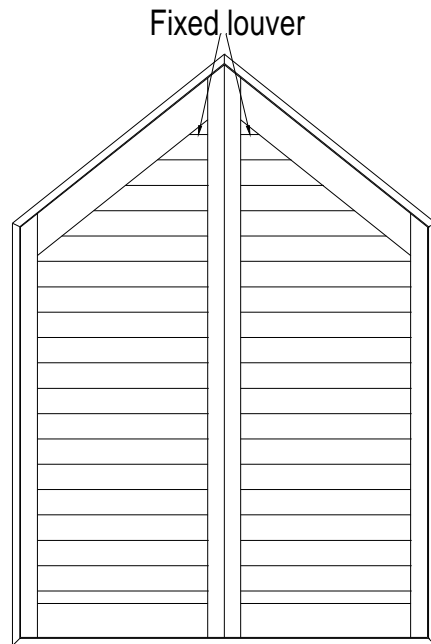

**Fixed louver**

**Peak**

# NORMAN® ULTRA

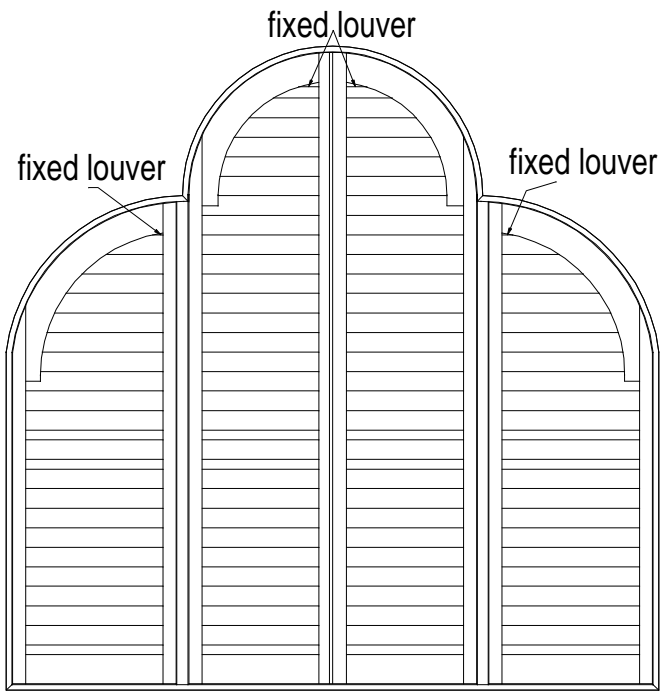

Horizontal louvers center arch  
with quarter round side panels  
-Standard louvered arch

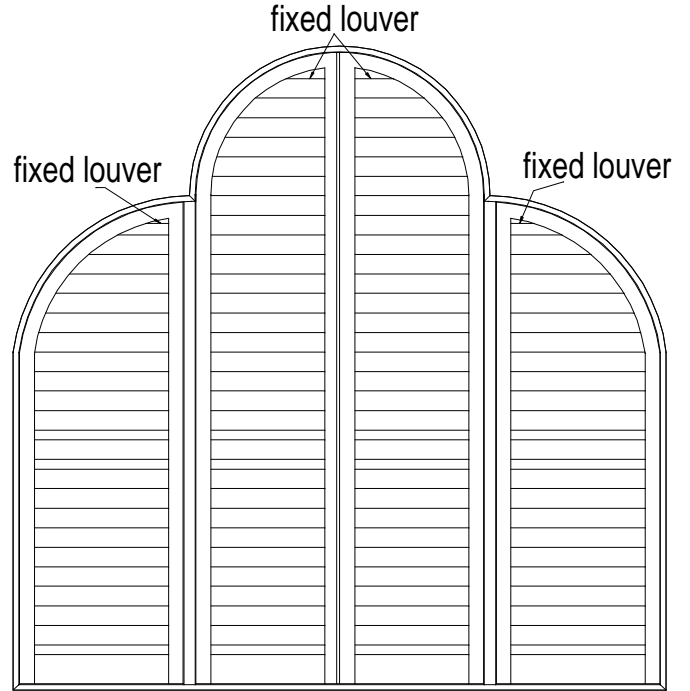

Horizontal louvers center arch  
with quarter round side panels  
-Continuous arch

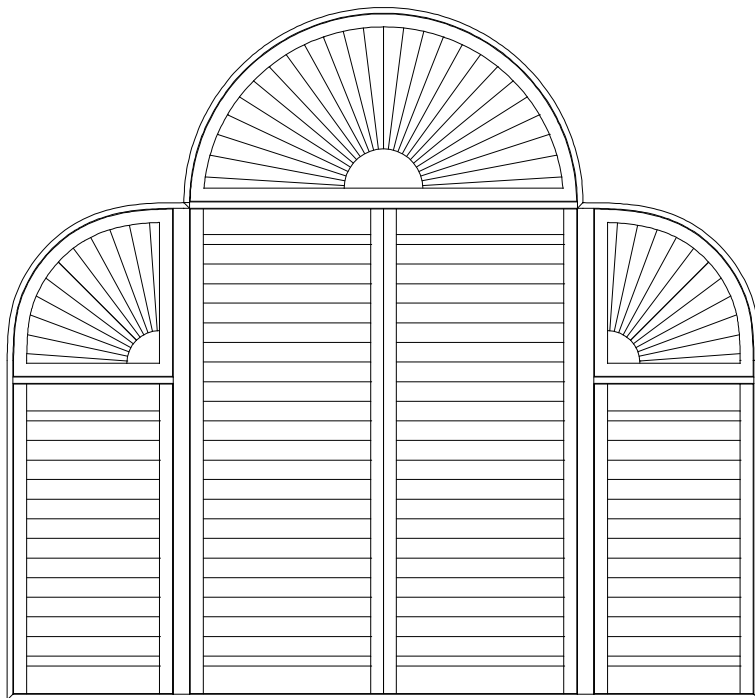

Sunburst louvers center arch with quarter round side panels

\*Some surcharges apply



# NORMAN® ULTRA

Fixed louver

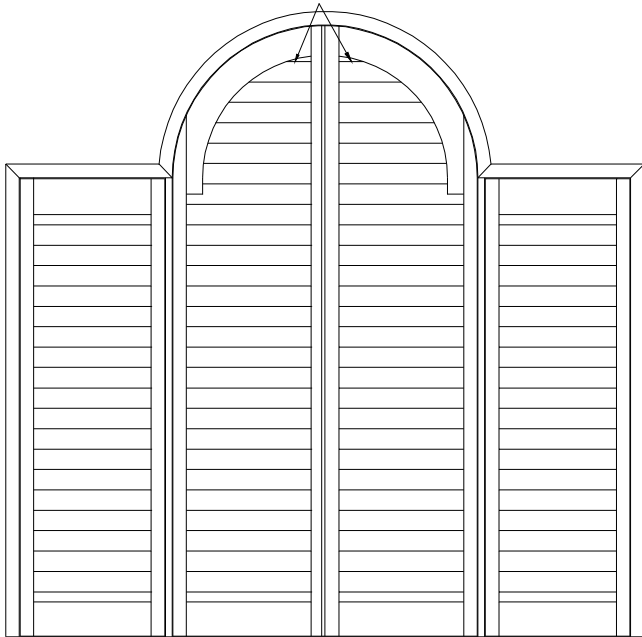

Arch Top Picture Window with horizontal louvers  
-Standard louvered arch

Fixed louver

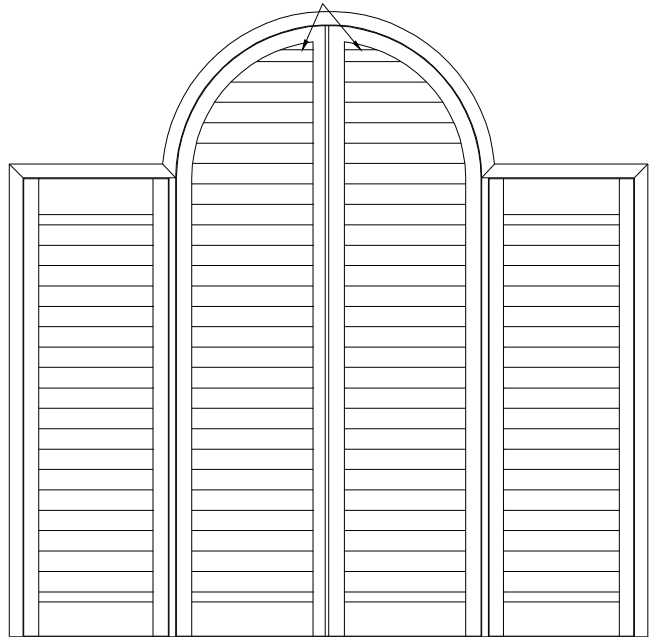

Arch Top Picture Window with horizontal louvers  
-Continuous arch

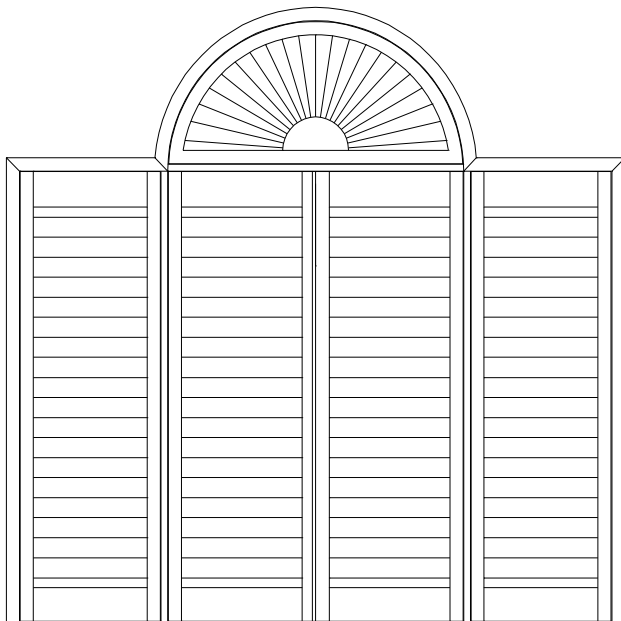

Arch Top Picture Window with Sunburst

fixed louver

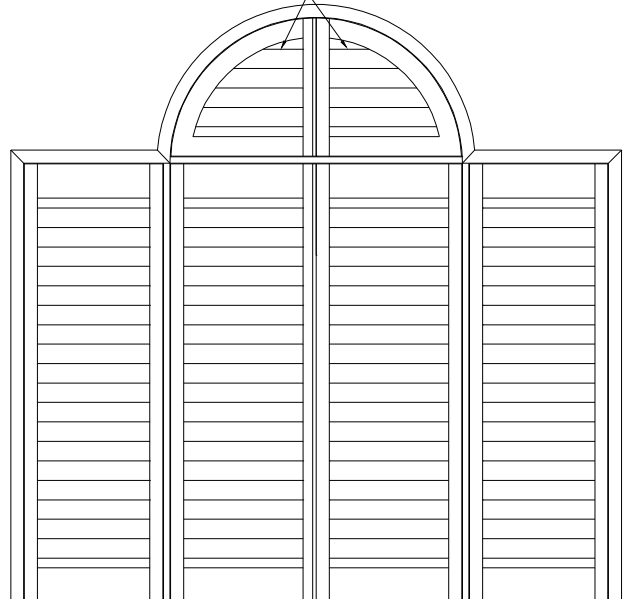

Standard unit with horizontal arch center

\*Some surcharges apply

NU I- 4

# NORMAN® ULTRA

## Pricing

<b>1) By Max Frame-to-Frame Measurement:</b>						
<b>Regular Shutter</b>						
Inside and Outside Mount	Width	x	Height	/ 144	x	\$/sq ft
<b>Track Shutter**</b>						
Inside	Width	x	Height	/ 144	x	\$/sq ft
Semi-Inside and Outside Mount	Width	x	(Height-1½")	/ 144	x	\$/sq ft
<b>2) By Net Panel Measurement:</b>						
	Width	x	Height	/ 144	x	\$/sq ft
<b>3) By Window Size:</b>						
<b>2 3/16" Classic Deco Frame</b> <b>2 3/16" Camber Deco Frame</b>	4-sided	(Width+4")	x	(Height+4")	/ 144	x \$/sq ft
	3-sided with Sill Plate	(Width+4")	x	(Height+4")	/ 144	x \$/sq ft
	3-sided	(Width+4")	x	(Height+2")	/ 144	x \$/sq ft
	2 sided with Sill Plate	(Width+4")	x	(Height+2")	/ 144	x \$/sq ft
	2-sided	(Width+4")	x	(Height)	/ 144	x \$/sq ft
<b>3 3/16" Ridge Deco Frame</b>	4-sided	(Width+6")	x	(Height+6")	/ 144	x \$/sq ft
	3-sided with Sill Plate	(Width+6")	x	(Height+6")	/ 144	x \$/sq ft
	3-sided	(Width+6")	x	(Height+3")	/ 144	x \$/sq ft
	2-sided with Sill Plate	(Width+6")	x	(Height+3")	/ 144	x \$/sq ft
	2-sided	(Width+6")	x	(Height)	/ 144	x \$/sq ft
<b>2.5" Mission deco frame</b>	4-sided	(Width+5")	x	(Height+5")	/ 144	x \$/sq ft
	3-sided	(Width+5")	x	(Height+2.5")	/ 144	x \$/sq ft
	2-sided	(Width+5")	x	(Height)	/ 144	x \$/sq ft
<b>3" Crown Z Frame</b>	4-sided	(Width+4 ½")	x	(Height+4½")	/ 144	x \$/sq ft
	3-sided with Sill Plate	(Width+4 ½")	x	(Height+4½")	/ 144	x \$/sq ft
	3-sided	(Width+4 ½")	x	(Height+2¼")	/ 144	x \$/sq ft
	2-sided with Sill Plate	(Width+4 ½")	x	(Height+2¼")	/ 144	x \$/sq ft
	2-sided	(Width+4 ½")	x	(Height)	/ 144	x \$/sq ft

\*This table is for pricing use only.

\*\*Surcharge for tracks and boxout are not included.

# Pricing

<b>2 1/4" Bel Air Z Frame</b> <b>2 1/4" Bullnose Z Frame</b>	4-sided	(Width+2 1/2")	x	(Height+2 1/2")	/ 144	x	\$/sq ft
	3-sided with Sill Plate	(Width+2 1/2")	x	(Height+2 1/2")	/ 144	x	\$/sq ft
	3-sided	(Width+2 1/2")	x	(Height+1 1/4")	/ 144	x	\$/sq ft
	2-sided with Sill Plate	(Width+2 1/2")	x	(Height+1 1/4")	/ 144	x	\$/sq ft
	2-sided	(Width+2 1/2")	x	(Height)	/ 144	x	\$/sq ft
<b>1 1/2" Bullnose Z Frame/</b> <b>1 1/2" Beaded Z Frame/</b> <b>Bullnose Tilt Out Z Frame</b>	4-sided	(Width+2")	x	(Height+2")	/ 144	x	\$/sq ft
	3-sided with Sill Plate (N/A w/ Tilt out Z)	(Width+2")	x	(Height+2")	/ 144	x	\$/sq ft
	3-sided	(Width+2")	x	(Height+1")	/ 144	x	\$/sq ft
	2-sided with Sill Plate (N/A w/ Tilt out Z)	(Width+2")	x	(Height+1")	/ 144	x	\$/sq ft
	2-sided	(Width+2")	x	(Height)	/ 144	x	\$/sq ft
<b>Vintage Hang Strip</b>	Inside	Width	x	Height	/ 144	x	\$/sq ft
	Outside 4-sided	(Width+3")	x	(Height+3")	/ 144	x	\$/sq ft
	Outside 3-sided	(Width+3")	x	(Height+1 1/2")	/ 144	x	\$/sq ft
	Outside 2-sided	(Width+3")	x	(Height)	/ 144	x	\$/sq ft
<b>Vintage L frame / Beaded L frame</b>	Outside 4-sided	(Width+3")	x	(Height+3")	/ 144	x	\$/sq ft
	Outside 3-sided	(Width+3")	x	(Height+1 1/2")	/ 144	x	\$/sq ft
	Outside 2-sided	(Width+3")	x	(Height)	/ 144	x	\$/sq ft
<b>Track Shutter**</b>							
Inside and Semi-Inside Mount		Width	x	Height	/144	x	\$/sq ft
Outside Mount		(Width+3")	x	(Height+3")	/144	x	\$/sq ft

\*This table is for pricing use only.

\*\*Surcharge for tracks and boxout are not included.