



By Ormesa



201 Growth Parkway Angola, IN 46703

Canadian Suggested Retail Price List in USD  
Jun-19

Phone: 260-665-2769

Fax: 260-665-3047

Email: [iim@mobility-usa.com](mailto:iim@mobility-usa.com)

[www.mobility-usa.com](http://www.mobility-usa.com)

Quote: \_\_\_\_\_

P.O. \_\_\_\_\_

**Bill To**

Dealer: \_\_\_\_\_ Contact: \_\_\_\_\_

Address: \_\_\_\_\_

City: \_\_\_\_\_ State: \_\_\_\_\_ Zip: \_\_\_\_\_

Phone: \_\_\_\_\_ Fax: \_\_\_\_\_

Email: \_\_\_\_\_ Mark For: \_\_\_\_\_

**Ship To**                      **Same as Bill To** \_\_\_\_\_

Dealer: \_\_\_\_\_ Contact: \_\_\_\_\_

Address: \_\_\_\_\_

City: \_\_\_\_\_ State: \_\_\_\_\_ Zip: \_\_\_\_\_

Phone: \_\_\_\_\_ Fax: \_\_\_\_\_

Email: \_\_\_\_\_ Mark For: \_\_\_\_\_

**New Bug Features and Specifications**

- **Seat** - can be used as a floor sitter, width and depth adjustable by 4" in each direction, small can be forward or reverse facing
- **Tilt & Recline** - incorporated in the seat 40°, easily adjusts with levers located on seat back
- **Headrest** - incorporated into the backrest so that the child always has a support
- **Backrest** - slightly contoured, can recline 40° (hinge coincides with child's center of gravity) height adjustable 4" with slots for accessories
- **Elevating Legrest** - push button adjustable, footrest is height and angle adjustable
- **Base** - black powder coated aluminum with an angle adjustable push-handle

**New BUG Seat** - includes: seat back, seat pan, tilt, and recline.

Part Number	Description	Price (USD)	HCPCS
_____ NBS	<b>New BUG Small</b>	\$1,500.00	E1399
_____ NBS3	<b>New BUG Medium</b>	\$1,600.00	E1399



**Outdoor Base Options**

Part Number	Description	Price (USD)	HCPCS
_____ NB869-1	<b>4-Wheel Base Sm</b>	\$1,900.00	E1238
_____ NB869-3	<b>4-Wheel Base Md</b>	\$2,000.00	E1238
_____ 891	<b>Set of Tie Down Hooks (Only available with NB869)</b>	\$275.00	K0108





Intended for forward-facing transport of the pushchair in a motor vehicle. Conforms with ISO 7176/19 and ANSI RESNA WC/19.



_____ NB901-1	<b>3-Wheel Base Sm</b> Ormesa has discontinued production on the 3 wheel base. We only have small 3 wheel bases in stock.	\$2,100.00	E1238
---------------	---	------------	-------



**Indoor Base Options**

Part Number	Description	Price (USD)	HCPCS	
NB856-1	Hi-Low Feeding Base Sm	\$1,850.00	E1399	
NB856-3	Hi-Low Feeding Base Md	\$1,950.00	E1399	
NB850-1	Floor Base Sm	\$660.00	E1399	
NB850-3	Floor Base Md	\$710.00	E1399	

**Colors** This price is only valid when purchasing a seat unit.

Part Number	Description	Price (USD)	
NBOR-1/NBOR-3	Orange	\$10.00	
NBBL-1/NBBL-3	Blue	\$10.00	
NBPK-1/NBPK-3	Pink	\$10.00	
NBLP-1/NBLP-3	Light Grey with Pink accent Available in August	\$10.00	
NBDP-1/NBDP-3	Dark Grey with Pink accent Available in August	\$10.00	
NBLG-1/NBLG-3	Light Grey with Green accent Available in August	\$10.00	
NBDG-1/NBDG-3	Dark Grey with Green accent Available in August	\$10.00	

**Footrest Options** Footplate and Hardware Required Parts

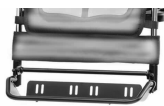
Part Number	Description	Price (USD)	HCPCS	
NB810-1	Angle Adjustable Flip Up Footplate Sm requires NB810-HW	\$125.00	K0040	
NB810-3	Angle Adjustable Flip Up Footplate Md requires NB810-HW	\$125.00	K0040	
NB810-HW	Footplate Hardware and Adjustment Tool	\$125.00	E1028	

**Footrest Accessories**

Part Number	Description	Price (USD)	HCPCS	
NB811	Calf Strap	\$50.00	E0995	
827	Foot Strap 8-11"	\$70.00	E0951	
827A	Foot Strap 11-14"	\$80.00	E0951	
NB892-1/2	Padded Foot Plate Sm	\$100.00	K0108	
NB892-3/4	Padded Foot Plate Md	\$100.00	K0108	

**Hip Guide Options** Hip Guides and Hardware Required Parts















Part Number	Description	Price (USD)	HCPCS	
<u>Size Small</u>				
NB815-L-1	Left Hip Guide width & angle adj armrest & upholstery requires NB815-HW	\$60.00	E0956	
NB815-R-1	Right Hip Guide width & angle adj armrest & upholstery requires NB815-HW	\$60.00	E0956	
NB815-L-HW/R-HW	Hardware for Hip Guide and Arm Rest	\$60.00	E1028	
<u>Size Medium</u>				
NB815-L-3	Left Hip Guide width & angle adj armrest & upholstery requires NB815-HW	\$60.00	E0956	
NB815-R-3	Right Hip Guide width & angle adj armrest & upholstery requires NB815-HW	\$60.00	E0956	
NB815-L-HW/R-HW	Hardware for Hip Guide and Arm Rest	\$60.00	E1028	

Client:











PO:

New Bug CAD

## Positioning Options

Part Number	Description	Price (USD)	HCP	CS	
817-1	Leg Straps Sm	\$135.00	K0038		
817-3	Leg Straps Md	\$135.00	K0038		
NB920-1/2	4 Point Pelvic Belt Sm	\$195.00	E0978		
NB920-3/4	4 Point Pelvic Belt Md	\$195.00	E0978		
894-1	45° Pelvic Belt Sm	\$95.00	E0978		
894-3	45° Pelvic Belt Md	\$95.00	E0978		
906-1	5 Point Harness Sm	\$130.00	E0960		
906-4	5 Point Harness Md	\$130.00	E0960		
NB903-1	5 Point Vest Harness Sm	\$295.00	E0960		
NB903-3	5 Point Vest Harness Md	\$295.00	E0960		
853	Vest Harness Sm	\$175.00	E0960		
853-3	Vest Harness Md	\$175.00	E0960		
NB868-1	Wrappable and Flexible Trunk Supports Sm height and depth adjustable	\$430.00	E0956		
NB868-3	Wrappable and Flexible Truck Supports Md height and depth adjustable	\$430.00	E0956		
HB435-S32-B1	Body Point X Small 4 Point Hip Belt WC19 Compliant - size 9" - 11"	\$130.00	E0978		
SH260XS-B1	Body Point X Small Pivot Fit Shoulder Harness WC19 Compliant - size 9" - 11"	\$155.00	E0960		
NB838-1	Lateral Pads Sm <small>requires NB838-HW</small>	\$100.00	E0956		
NB838-3	Lateral Pads Md <small>requires NB838-HW</small>	\$100.00	E0956		
NB838-HW	Lateral Hardware height and depth adjustable	\$150.00	E1028		
NB834-1	Padded Abduction Block with Hardware Sm depth adjustable	\$140.00	E0957		
NB834-3	Padded Abduction Block with Hardware Md depth adjustable	\$140.00	E0957		
NB852-1	Headrest w/ Parietal Supports Sm fixed, height adjustable	\$290.00	E0955		
NB852-3	Headrest w/ Parietal Supports Md fixed, height adjustable	\$290.00	E0955		
NB863-1	Headrest w/ Occipital-Parietal Supports Sm <small>requires NB863-HW</small>	\$290.00	E0955		
NB863-3	Headrest w/ Occipital-Parietal Supports Md <small>requires NB863-HW</small>	\$290.00	E0955		
NB863-HW	Multi Axis Hardware - angle and depth adjustable	\$265.00	E1028		
NB942-1	Ergonomic Headrest Sm <small>requires NB942-HW</small>	\$290.00	E0955		
NB942-3	Ergonomic Headrest Md <small>requires NB942-HW</small>	\$290.00	E0955		
NB942-HW	Multi Axis Hardware - angle and depth adjustable	\$170.00	E1028		

## Accessories

Part Number	Description	Price (USD)	HCPCS	
NB819-1	<b>Black Retractable Canopy Sm</b> front and rear view window requires NB819-HW	\$295.00	K0108	
NB819-3	<b>Black Retractable Canopy Md</b> front and rear view window requires NB819-HW	\$295.00	K0108	
NB819-HW	<b>Canopy Hardware</b>	\$95.00	E1028	
NB825-1	<b>Black Rain Cover Sm</b> requires NB819	\$140.00	K0108	
NB825-3	<b>Black Rain Cover Md</b> requires NB819	\$140.00	K0108	
NB824-1	<b>Transparent Table with Edge &amp; Hollow Sm</b> requires NB824-HW	\$240.00	E0950	
NB824-3	<b>Transparent Table with Edge &amp; Hollow Md</b> requires NB824-HW	\$240.00	E0950	
NB824-HW	<b>Adjustable and Removable Table Hardware</b>	\$100.00	E1028	
NB839-1	<b>Front Handle Sm</b>	\$200.00	K0108	
NB839-3	<b>Front Handle Md</b>	\$200.00	K0108	
818	<b>Black Thermal Cover Sm</b>	\$365.00	K0108	
818-3	<b>Black Thermal Cover Md</b>	\$365.00	K0108	
858	<b>Medical Necessity Basket Sm</b> Not compatible with NB927 or NB935	\$125.00	K0108	
858-3	<b>Medical Necessity Basket Md</b> Not compatible with NB927 or NB935	\$125.00	K0108	
NB927-1	<b>Vent Tray Sm</b> Not compatible with 858	\$650.00	E1029	
NB927-3	<b>Vent Tray Md</b> Not compatible with 858	\$650.00	E1029	
922	<b>Water Bottle Holder</b>	\$45.00	K0108	
NB935	<b>Oxygen Bottle Holder Sm</b> Not compatible with 858	\$250.00	E2208	
NB935-3	<b>Oxygen Bottle Holder Md</b> Not compatible with 858	\$250.00	E2208	
NB-IV	<b>IV Pole</b>	\$495.00	K0108	

**Client Measurements:**

A Back height: \_\_\_\_\_ F Lower leg length: \_\_\_\_\_  
 B Chest depth: \_\_\_\_\_ G Head height: \_\_\_\_\_  
 C Chest width: \_\_\_\_\_ H Arm height: \_\_\_\_\_  
 D Seat depth: \_\_\_\_\_ Age: \_\_\_\_\_  
 E Seat width: \_\_\_\_\_ Weight: \_\_\_\_\_

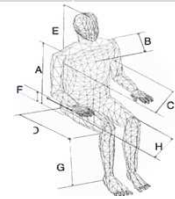

**DIMENSIONS**

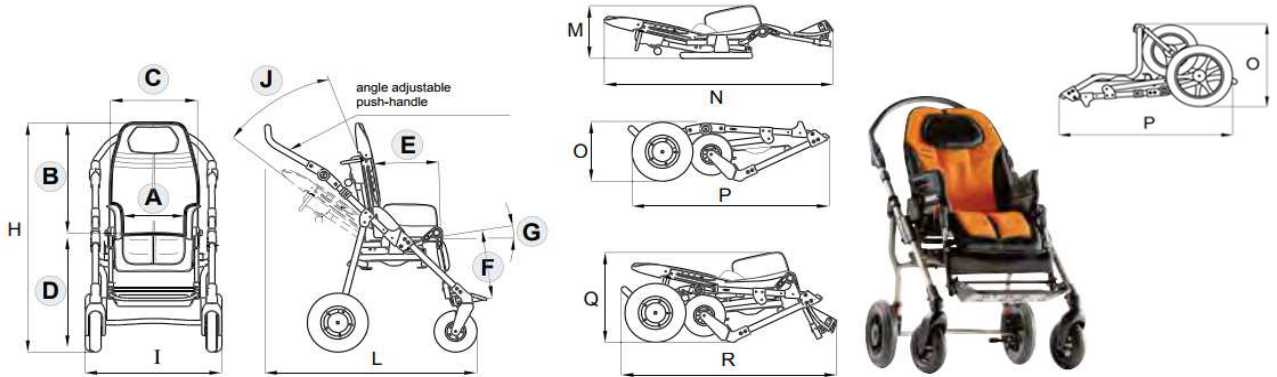

Measurements in Inches

Seat & Bases	MAX LOAD	A	B	C	D	E	F	G	J	H	I	L	M	N	O	P	Q	R	FRAME WEIGHT	SEAT WEIGHT	TOTAL WEIGHT
Sm 4 wheel	77 lbs	8 - 11	20 - 24	14.5	20.5	8 - 12	5 - 12	0° - 35°	35°	41 - 45	22.5	26 - 37	11.5	34.5	11.5	32	17	32	21	19	40
Md 4 wheel	99 lbs	10 - 14	24 - 30	17	21.5	12 - 16	12 - 16	0° - 25°	40°	45 - 51	24.5	32 - 42	13.5	44	14	36	20.5	37	25	25	48
Sm 3 wheel	77 lbs	8 - 11	20 - 24	14.5	20.5	8 - 12	5 - 12	0° - 35°	35°	41 - 45	22.5	26 - 37	11.5	34.5	16	31	N/A	N/A	23	19	42
Md 3 wheel	99 lbs	10 - 14	24 - 30	17	21.5	12 - 16	12 - 16	0° - 25°	40°	45 - 51	24.5	32 - 42	13.5	44	16	38	N/A	N/A	25	25	50
Sm Hi/Low	77 lbs	8 - 11	20 - 24	14.5	18.5 - 29	8 - 12	5 - 12	0° - 35°	35°	39 - 53	22	14 - 24	31	16	9	N/A	N/A	N/A	32	19	51
Md Hi/Low	99 lbs	10 - 14	24 - 30	17	18.5 - 29	12 - 16	12 - 16	0° - 25°	40°	42 - 58	24	14 - 24	33	18	13	N/A	N/A	N/A	34	25	59
Sm floor base	77 lbs	8 - 11	20 - 24	14.5	6.5	8 - 12	5 - 12	0° - 35°	35°	27 - 31	18	2.5	24	16	9	N/A	N/A	N/A	10	19	29
Md floor base	99 lbs	10 - 14	24 - 30	17	6.5	12 - 16	12 - 16	0° - 25°	40°	30 - 36	20	2.5	25	18	11	N/A	N/A	N/A	12	25	37

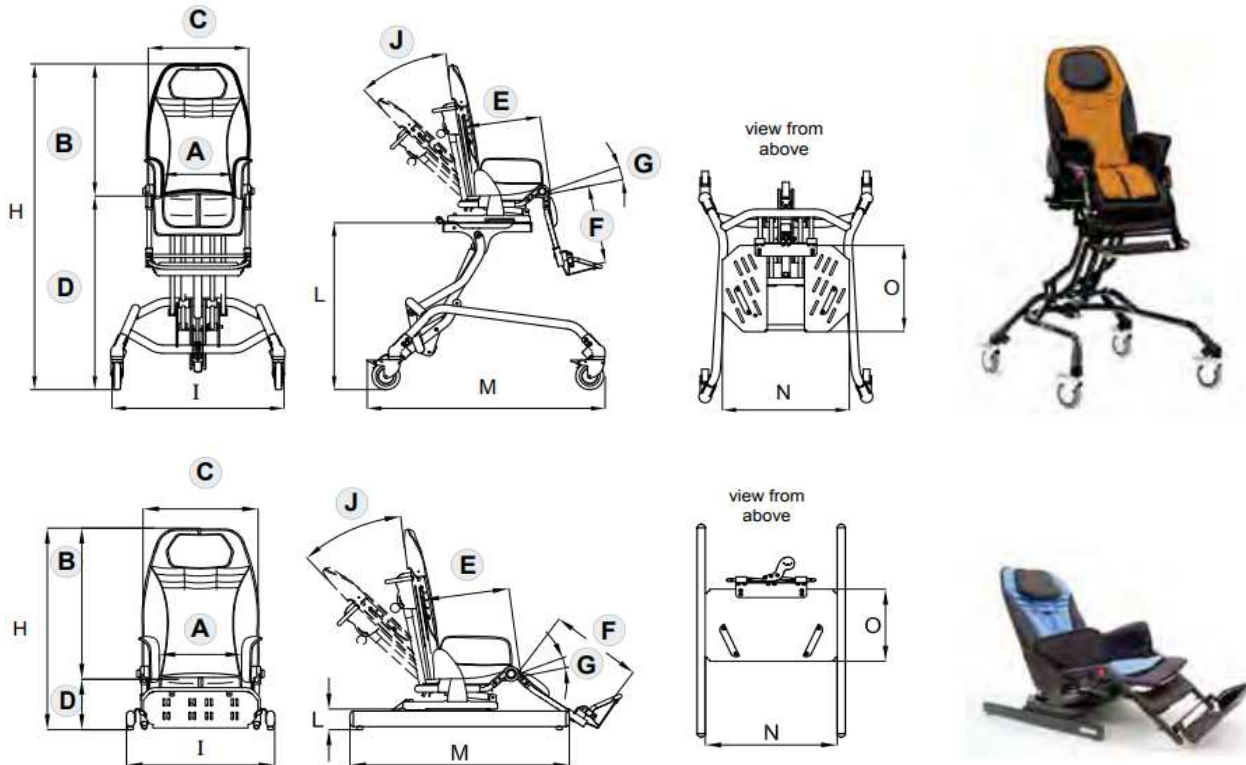

Note: All specification and prices are subject to change without notice. Prices listed are only valid if ordering with a base. The HCPCS codes provided are not intended to be billing or legal advice, rather Innovation In Motion's interpretation of the code definitions. Use of the codes provided does not ensure coverage or payment for the item. For coverage information, verify the policy of the appropriate payer. It is recommended to contact Innovation In Motion with any questions regarding proper ordering of the chair at 1-260-665-2769.