



**TALCO**  
**Home Inspe**

## **Inspection Report**

**Mr. Mark Stevens**

**Property Address:**  
3002 Wheeler Street  
Georgetown KY 40324





**Talon Home Inspections, LLC**

**Giancarlo Barone HI-103 758  
4101 Tates Creek Centre Drive  
Suite 150 - PMB 312  
Lexington, KY, 40517  
(859) 447 0050**

*G. Barone*





## Table of Contents

<a href="#">Cover Page</a> .....	1
<a href="#">Table of Contents</a> .....	5
<a href="#">Intro Page</a> .....	6
<a href="#">1 Structural Components</a> .....	8
<a href="#">2 Roofing / Chimneys / Roof Structure and Attic</a> .....	15
<a href="#">3 Exterior</a> .....	26
<a href="#">4 Garage/Carport</a> .....	32
<a href="#">5 Kitchen / Components and Appliances</a> .....	35
<a href="#">6 Rooms</a> .....	39
<a href="#">7 Bathroom and Components</a> .....	47
<a href="#">8 Plumbing System</a> .....	52
<a href="#">9 Electrical System</a> .....	61
<a href="#">10 Heating / Central Air Conditioning</a> .....	63
<a href="#">Repair/ Replace General Summary</a> .....	72
<a href="#">Conditional General Summary</a> .....	87
<a href="#">Invoice</a> .....	97
<a href="#">Back Page</a> .....	98

<b>Date:</b> 8/22/2018	<b>Time:</b> 12:00 PM till 04:00 PM	<b>Report ID:</b> 140822WILLOUGHBY
<b>Property:</b> 3002 Wheeler Street Georgetown KY 40324	<b>Customer:</b> Mr. Mark Stevens	<b>Real Estate Professional:</b>

## **Congratulations and Thank you for choosing Talon Home Inspections.**

In order for you to receive the full value of this inspection please read all of the information in your Inspection Report. Should you have further questions, please contact our office during regular business hours 7 days a week and we will be happy to assist you.

## **Photo/Video Documentation.**

Your report includes many photographs. Most of the pictures are a general view, to help you understand where the inspector has been, what is looked at, and the condition of the item or area at the time of the inspection. Most of the pictures will be of problem areas, the pictures are to help you better understand what is documented in the report and to help you see areas or items that you normally would not see. Not all problem areas and conditions will be supported with pictures, that will be up to the discretion of the inspector.

## **Comment Key or Definitions**

The following definitions of comment descriptions represent this inspection report. All comments by the inspector should be considered before purchasing this home. Any recommendations by the inspector to repair or replace suggests a repair, second opinion or further inspection by a qualified contractor. All costs associated with further inspection fees and repair or replacement of an item, component or unit should be strongly considered before you purchase the property.

**Inspected (IN)** = I visually observed the item, component or unit and if no other comments were made then it appeared to be functioning as intended allowing for normal wear and tear.

**Not Inspected (NI)** = I did not inspect this item, component or unit and made no representations of whether or not it was functioning as intended and will state a reason for not inspecting.

**Not Present (NP)** = This item, component or unit is not in this home or building.

**Conditional (C)** = I visually observed the item, component or unit and it appeared to be functioning as intended, but is in need of a minor repair and/or correction. This will ensure the item, component or unit is performing or functioning as intended.

**Repair or Replace (RR)** = The item, component or unit is not functioning as intended, or is defective, is unsafe or hazardous, or needs further inspection/evaluation by a qualified contractor. All comments made that are marked as Repair or Replace in this report and/or in the summary should be dealt with before you purchase the property.

**Note:** Any Items, components or units mentioned in the report that can be repaired to satisfactory condition may not need replacement.

## **THIS REPORT IS NOT A WARRANTY.**

**Our report is not a guarantee or warranty on the condition of the property or its contents. This inspection service only warrants that its inspection service and report will be performed in accordance with scope and standards of practice of the American Society of Home Inspectors (ASHI).**

## Definition of A Home Inspection

By definition, a home inspection is a visual analysis performed for compensation for the purpose of providing a professional opinion and home inspection report by a licensed home inspector, regarding the condition of a residential dwelling and the dwelling's attached garages and carports, any reasonable accessible installed components, and the operation of the dwelling's systems, including any controls normally operated by the owner of the dwelling, for systems and components in the standards of practice established by the Kentucky Board of Home Inspectors. Home inspection does not include a code compliance inspection. The obligations of a home inspector to a client do not extend to third parties who did not hire the home inspector or rely on the inspector's opinions.

**Standards of Practice:**

American Society of Home Inspectors

**In Attendance:**

Customer's Agent, Vacant (inspector only)

**Type of building:**

Single Family (1 story)

**House Built In:**

2002

**Home Faces:**

SW

**Utilities Status:**

All utilities On

**Temperature:**

70-80

**Weather:**

Partly Cloudy

**Ground/Soil surface condition:**

Wet

**Rain in last 3 days:**

Yes

1. Structural Components



The Home Inspector shall observe structural components including foundations, floors, walls, columns or piers, ceilings and roof. The home inspector shall describe the type of Foundation, floor structure, wall structure, columns or piers, ceiling structure, roof structure. The home inspector shall: Probe structural components where deterioration is suspected; Enter under floor crawl spaces, basements, and attic spaces except when access is obstructed, when entry could damage the property, or when dangerous or adverse situations are suspected; Report the methods used to observe under floor crawl spaces and attics; and Report signs of abnormal or harmful water penetration into the building or signs of abnormal or harmful condensation on building components. The home inspector is not required to: Enter any area or perform any procedure that may damage the property or its components or be dangerous to or adversely effect the health of the home inspector or other persons.







**Styles & Materials**

**Foundation Type:**

Crawlspace

**Foundation Wall Structure:**

Poured Concrete

**Method used to observe Crawlspace:**

Crawled

**Floor Structure:**

2 X 10  
and  
2 X12  
Wood joists and beams

**Wall Structure:**

Masonry  
and  
Wood frame construction

**Columns/ Posts or Piers:**

Masonry Block Piers

**Floor System Insulation (Type/R value):**

Unfaced Batts  
R-13

		IN	NI	NP	C	RR
1.0	Crawlspace Access	•				
1.1	Crawlspace / Wall Foundation	•				
1.2	Crawlspace Floor (Vapor Retarders)				•	
1.3	Wall Structure	•				
1.4	Floors (Structural)	•				

IN= Inspected, NI= Not Inspected, NP= Not Present, C= Conditional, RR= Repair or Replace

**IN NI NP C RR**

		IN	NI	NP	C	RR
1.5	Insulation under Floor Systems				•	
1.6	Columns and/or Piers	•				
1.7	Ceilings (Structural)	•				
1.8	Ventilation of Foundation Area (crawlspce or basement)	•				
1.9	Electrical Crawlspace / Basement					•
1.10	General Comments	•				

IN= Inspected, NI= Not Inspected, NP= Not Present, C= Conditional, RR= Repair or Replace

**IN NI NP C RR**

**Comments:**

**1.0** Access to the crawlspace is located at the left side of the home.



1.0 Item 1(Picture)

**1.2** (1) All wood should be removed from the crawlspace floor. Wood debris risks rotting and can attract wood eating insects into the crawlspace which can lead to more costly repairs later. Recommend all types of debris resting on the crawlspace floor be removed to prevent damage to the wood structure of the home.



1.2 Item 1(Picture)

**1.2** (2) There are some gaps in the coverage of the vapour barrier in the crawl space floor where indicated in the photo(s). The vapor barrier in the crawl space floor should be adjusted to cover all areas of exposed soil. These gaps are allowing moisture vapor entry into the crawl space which promotes condensation, humidity and mold/mildew growth on the floor joists. The plastic vapour barrier should be a minimum of 9mil thick in Kentucky (recommend using 15 or 20 mil) straightened and/or added to as needed to cover the entire crawlspace floor to prevent excessive moisture entering. Recommend correcting as needed using a qualified contractor.



1.2 Item 2(Picture)



1.2 Item 3(Picture)



1.2 Item 4(Picture)

**1.3** The wall structure is not visible due to exterior and interior walls are covered. There were no obvious signs of any problems.

**1.4 (1)** Mildew was noted on some of the floor joists in the crawlspace mainly at the rear of the home. This is usually due to excess humidity and/or poor ventilation. Foundation moisture problems should be addressed. Proper ventilation helps control humidity and reduces the risk of rot. This is for your information. Recommend the crawlspace be monitored during the seasons and if condensation occurs, recommend a qualified contractor further investigate to determine cause and correct problem as needed.

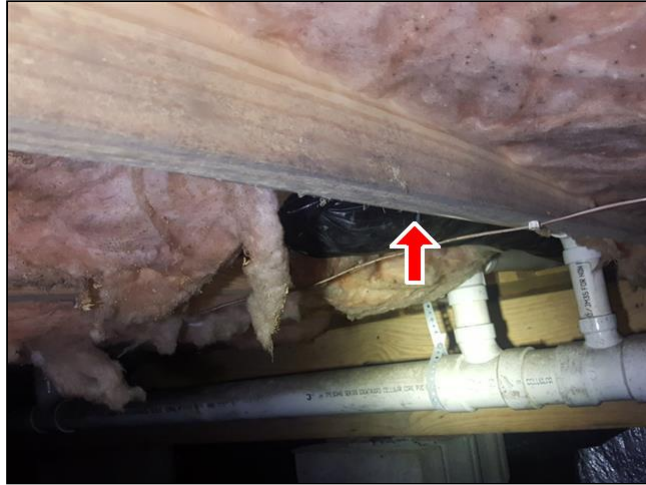
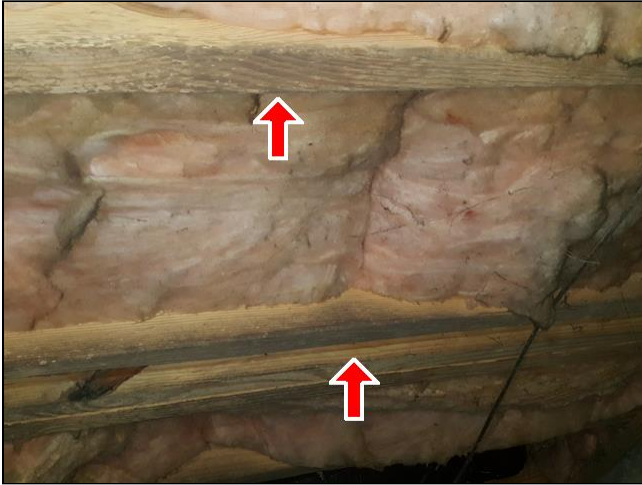

1.4 Item 1(Picture)

1.4 Item 2(Picture)

**1.4 (2)** Old water stain on the floor joist and sub floor was noted under the master bathroom, shower area in the crawlspace. There was no evidence of water leaking at the time of inspection. The wood is firm and not rotted. The area tested dry at the time of the inspection. Check with the owner for possible explanation. If they are unaware recommend this area be monitored to see if a leak does exist or you may wish to have a qualified plumber further investigate to determine if a leak does exist.



1.4 Item 3(Picture)

1.5 The insulation is loose/fallen in the crawlspace under the 3rd bedroom area. Recommend repair/correction as needed.



1.5 Item 1(Picture)

1.7 The ceilings in the home are covered and structural members are not visible due to insulation and ceiling coverings. No obvious problems discovered. I could not see behind these coverings. Was only able to partially examine ceiling structure.

1.9 Wires that are connected with twist caps in a crawlspace need to be placed in a junction box to prevent tampering, protect the wire connections, and for personal protection. This is a safety issue that needs to be corrected. If a leak was to occur it could result in a short then a fire in the home. Recommend a qualified licensed electrician correct as needed.

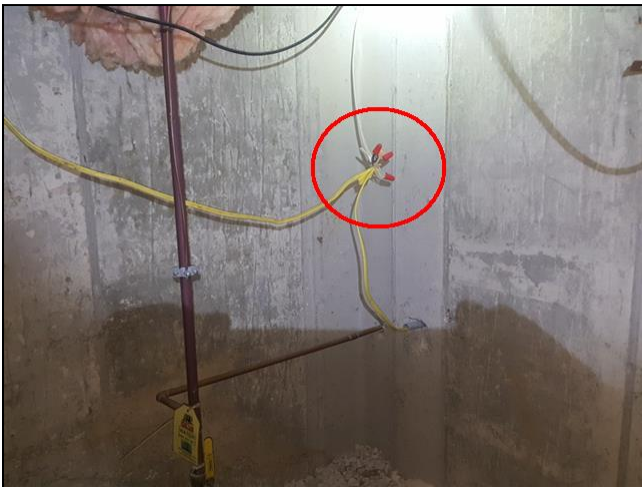

1.9 Item 1(Picture) under 3rd bedroom area

### Electrical Wire Splices Without Box

All splices in 110/120 or higher voltage must be inside an approved metal or plastic box. This protects the splice, supports the wire, and provides fire safety.

© Tom Feiza Mr. Fix-It Inc.

E098

1.9 Item 2(Picture)

**1.10** No evidence of moisture, condensation or water was visible in the crawlspace at the time of the inspection. It should be understood that it is impossible to predict whether moisture penetration will pose a problem in the future. The vast majority of crawlspace leakage problems are the result of insufficient control of storm water at the surface. The ground around the house should be sloped to encourage water to flow away from the foundations. Gutters and downspouts should act to collect roof water and drain the water at least six feet from the foundation, or into a functional storm sewer. Downspouts that are clogged or broken below grade level, or discharge too close to the foundation, are the most common source of crawlspace leakage. Please refer to the Roofing and Exterior sections of the report for more information. In the event that crawlspace leakage problems are experienced, lot and roof drainage improvements should be undertaken as a first step.

---

The structure of the home was inspected and reported on with the above information. While the inspector makes every effort to find all areas of concern, some areas can go unnoticed. Please be aware that the inspector has your best interest in mind. Any repair items mentioned in this report should be considered before purchase. It is recommended that qualified contractors be used in your further inspection or repair issues as it relates to the comments in this inspection report.

2. Roofing / Chimneys / Roof Structure and Attic



The home inspector shall observe: Roof covering; Roof drainage systems; Roof ventilation; Roof framing; Flashings; Skylights, Chimneys, and roof penetrations; Attic insulation and thickness; sheathing and decking; and Signs of leaks or abnormal condensation on building components. The home inspector shall describe material comprising the roof structure; roof covering materials; and Report methods used to observe the roofing and attic. The home inspector is not required to: Walk on the roofing; or Observe attached accessories including but not limited to solar systems, antennae, lightning arrestors, or similar attachments; Enter attic spaces with headroom of less than 5 feet; or if there are obstructions; and other detrimental conditions.





**Styles & Materials**

**Viewed roof covering from:**

- Ground
- Ladder
- Binoculars

Limitations: Some areas of the roof is to high for inspector's ladder to reach

**Roof Ventilation:**

- Soffit and Passive Vents and Gable vents

**Attic Access Location/Info:**

- Pull down ladder located in: Garage Ceiling
- Partial storage light in attic

**Roof-Type:**

Gable Dimensional

**Chimney (exterior):**

None

**Method used to observe attic:**

- Walked
- Partially inaccessible due to safety and access
- Inaccessible areas were viewed with flashlight

**Roof Covering:**

- 3-Tab Composition Architectural shingles

**Sky Light(s):**

None

**Roof Structure:**

- Stick-built
- Lateral bracing
- Vertical support
- 2 X 6 Rafters and 2 X 10 Rafters
- OSB (Oriented Strand Board) Sheathing



**Ceiling Structure:**

2X6  
Wood Joists  
Partially visible

**Attic Insulation:**

Blown Cellulose

		IN	NI	NP	C	RR
2.0	Roof Coverings - Asphalt	•				
2.1	Roof Flashings	•				
2.2	Roof Penetrations- Vents, Skylights, Etc	•				
2.3	Roof Drainage Systems (drip edge, gutters, downspouts, and splashblocks)				•	
2.4	Attic Access	•				
2.5	Roof Structure and Attic (Report leak signs or condensation)	•				
2.6	Roof/Attic Ventilation	•				
2.7	Ventilation Fans and Thermostatic Controls (Attic)	•				
2.8	Attic Insulation	•				
2.9	Attic Electrical (Visible Electric Wiring in Attic, Switches, Outlets, and Light Fixtures)					•
2.10	Attic Plumbing		•			
2.11	General Notes	•				

IN= Inspected, NI= Not Inspected, NP= Not Present, C= Conditional, RR= Repair or Replace

**IN NI NP C RR**

**Comments:**

**2.1** Some of the roof flashings are not visible for inspection due to building materials have hidden flashings that are never visible.

2.3 (1) Downspouts that discharge below grade level should be monitored. If they are ever suspected to be clogged or disconnected below grade, they should be redirected to discharge at least 10 feet from the building or into a storm sewer system. Foundation leakage adjacent to a downspout is an indication of a problem below grade.



2.3 Item 1(Picture) front left corner of garage



2.3 Item 2(Picture) front center of home

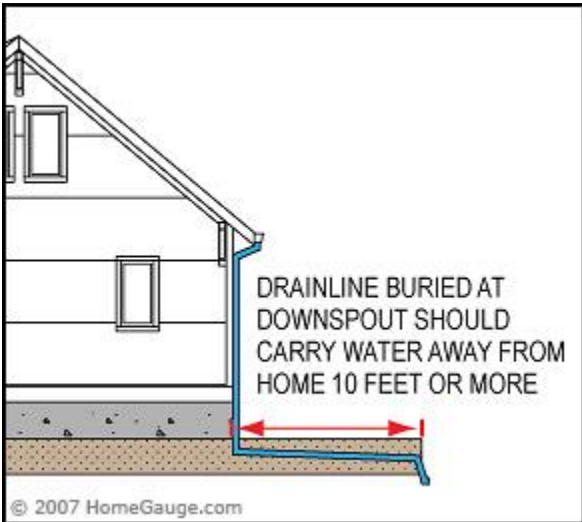

2.3 Item 3(Picture)

**2.3** (2) Recommend the downspout(s) at the front right corner of the garage be re-directed and extended at least 6 feet and flow onto splashblocks so water flows away from the foundation perimeter. This will ensure water is kept away from the foundation perimeter, soil erosion does not occur and water cannot leak under the slab foundation. Also this will prevent settlement from occurring around the foundation perimeter. Recommend repair and replacement as needed.



2.3 Item 4(Picture)

**2.3** (3) Recommend the downspout(s) at the home where indicated in the photo(s) be extended at least 6 feet and flow onto splashblocks. This will ensure water is kept away from the foundation perimeter, soil erosion does not occur and water cannot leak into the crawlspace area which may cause settlement of the foundation.

Note: You may wish to consider burying the extension to prevent a tripping hazard. See photos for example.



2.3 Item 5(Picture) front left corner of home



2.3 Item 6(Picture) rear right corner of home



2.3 Item 7(Picture) rear left side of home



2.3 Item 8(Picture)



2.3 Item 9(Picture)

**2.4** Attic access location (see photo)



2.4 Item 1(Picture) garage

2.5 There is no 1/8" spacing or ply clips at the ends, joins or sides of the roof sheathing as is recommended. Without this space the edges of the sheathing could raise if moisture enters and expands the sheathing. The raised areas could then be easily seen as the shingles conform to the surface of the roof sheathing on the outside. No problems were found at time of inspection. If this condition appears and is bothersome the shingles will need to be removed and the sheathing replaced or if possible a relief joint cut at the edges of the sheathing by a qualified roofing contractor. At the moment this is not a high priority. Strongly recommend that when a new roof is installed that this be done then.



2.5 Item 1(Picture)

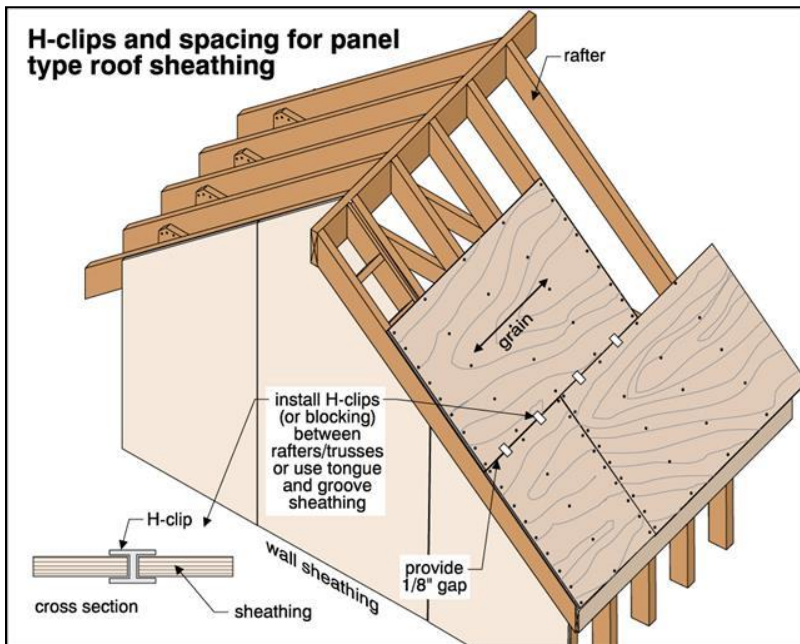

2.5 Item 2(Picture)

2.7 The thermostatic controlled vent fan in the garage attic was working at the time of the inspection.



2.7 Item 1(Picture)

2.8 (1) Cellulose insulation is about seven inches thick or 20 R-Value.

2.8 (2) You may wish to consider adding more insulation in the attic to increase the "R" value. This will improve efficiency of the HVAC system and reduce heating and cooling costs. This is for your information.

[Insulation Recommendation for Kentucky](#)

2.9 The wiring installation of the power vent in the garage attic is non-standard. It is suspected that an amateur, rather than a licensed electrician or HVAC contractor performed the installation. Splices in electrical wiring should be enclosed in junction boxes and fitted with cover plates. This is a safety issue . Recommend a licensed electrician repair as needed to prevent accidental electric shocks.



2.9 Item 1(Picture)

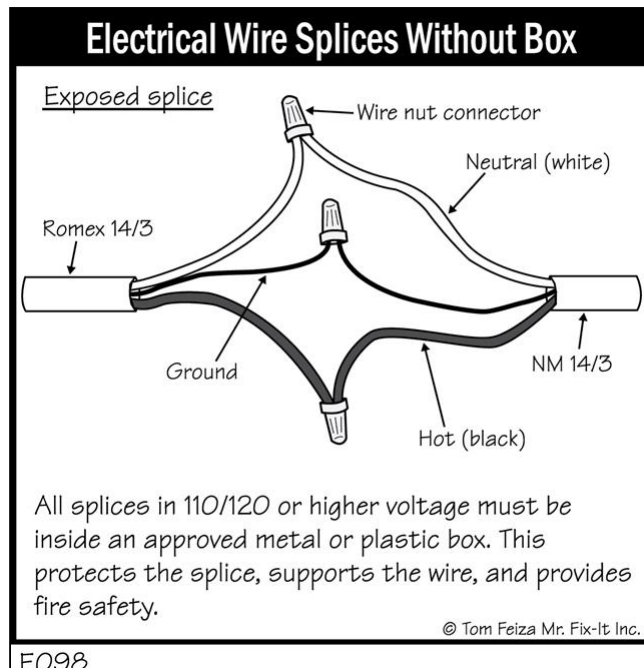

E098

2.9 Item 2(Picture)

2.11 (1) For safety reasons, walking on the roof exceeds the scope of a general home inspection as required by the Standards of Practice. To ensure the safety of the inspector it is our policy that readily visible areas of the roof surfaces and components are to be inspected from a safe vantage point using binoculars from the ground or ladder. This policy is in compliance with the Kentucky Board of Home Inspectors approved Standards of Practice.



**2.11** (2) Limited inspection of the attic was performed at the home. The home has vaulted ceilings above the 3rd bedroom and living room areas, therefore no safe access or real attic present. This prevented an inspection of the structural materials, insulation, moisture conditions, etc. located within the attic in this area of the home. This is for your information.

---

The roof of the home was inspected and reported on with the above information. While the inspector makes every effort to find all areas of concern, some areas can go unnoticed. Roof coverings and skylights can appear to be leak proof during inspection and weather conditions. Our inspection makes an attempt to find a leak but sometimes cannot. Please be aware that the inspector has your best interest in mind. Any repair items mentioned in this report should be considered before purchase. It is recommended that qualified contractors be used in your further inspection or repair issues as it relates to the comments in this inspection report.

**3. Exterior** 

The home inspector shall observe: Wall cladding, flashings, and trim; Entryway doors and a representative number of windows; Attached porches, decks, stairs, steps, landings, and applicable railings; Eaves, soffits, and fascias; and Vegetation, intrusive trees, grading, drainage, driveways, patios, walkways, and retaining walls with respect to their effect on the condition of the building. The home inspector shall: Describe wall cladding materials; Describe wall covering materials and type; material for driveways, walkways, and other items contiguous with the inspected structure; Operate and observe all entryway doors and a representative number of windows; and Probe exterior wood components where deterioration is suspected. The home inspector is not required to evaluate function of: Storm windows, storm doors, screening, shutters, awnings, and similar seasonal accessories; The home inspector is not required to observe: Fences; Evaluate the condition of; Trees, vegetation, Geological conditions, Soil conditions, and privacy walls; Recreational facilities (including spas, saunas, hot tubs, swimming pools, tennis courts, playground equipment, and other exercise, entertainment, or athletic facilities); Detached buildings or structures; test or inspect for; window glass type; integrity of thermal window seals; operation of security locks, devices, or systems; Evaluate the presence, extent and type of insulation and vapour barriers in exterior walls; or Presence or condition of buried fuel storage tanks. The home inspector is not required to: Move personal items, panels, furniture, equipment, plant life, soil, snow, ice or debris that obstructs access or visibility.

**Styles & Materials**

**Siding Material:**

Brick veneer

**Exterior Entry Doors:**

Metal Door  
and  
Sliding Door

**Appurtenance:**

Covered porch with steps

**Driveway:**

Concrete

		IN	NI	NP	C	RR
3.0	Siding and Trim					•
3.1	Eaves, Soffits, Fascias and Paint	•				
3.2	Doors (Front and Rear Exterior)	•				
3.3	Windows	•				
3.4	Porches, Balconies, Areaways, Stoops, Steps, and Applicable Railings	•				
3.5	Decks, Structure, Railings, Stairs					•
3.6	Driveways, Walkways (With respect to their effect on the condition of the building)					•
3.7	Patio Floor, Covered Patio (With respect to their effect on the condition of the building)			•		
3.8	Grading, Drainage, (With respect to their effect on the condition of the building)	•				
3.9	Vegetation, (With respect to their effect on the condition of the building)				•	
3.10	Plumbing Water Faucets (hose bibs)	•				
3.11	Outlets, Switches, Light Fixtures, (Exterior)	•				

IN= Inspected, NI= Not Inspected, NP= Not Present, C= Conditional, RR= Repair or Replace

IN NI NP C RR

**Comments:**

**3.0** No weep holes were found on the brick veneer. Weep holes are openings close to the bottom of the brick mortar joints that allow drainage. They are also recommended over door and window openings. Felt paper as well as metal flashing are commonly used for this purpose but cannot be seen without removal of the brick. Any water that might enter behind the brick against wood could cause decay. No visible signs of damage was found during the inspection. It is recommended that these weep holes be installed. A qualified masonry contractor should further investigate and correct if needed.

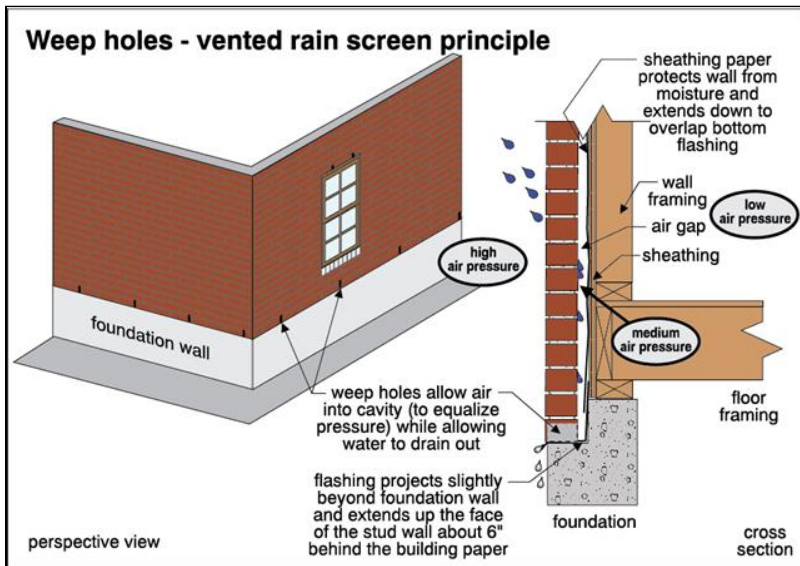

3.0 Item 1(Picture)

**3.5 (1)** Some of the concrete footers have settled creating the post to pull away and tilt from the band board. Over time further settlement of the footers may cause the deck to possibly fail in the future. This is a safety issue. Recommend a qualified contractor repair as needed to ensure structural integrity of the deck and to prevent further settlement or leaning of the posts.



3.5 Item 1(Picture)



3.5 Item 2(Picture)

**3.5 (2)** 2x4s are installed for handrails for the deck staircase and are not considered "gripable" by industry standards. This is a safety issue and an injury could occur if not corrected. Recommend that a standard approved handrail be installed for safety by a general contractor.



3.5 Item 3(Picture)

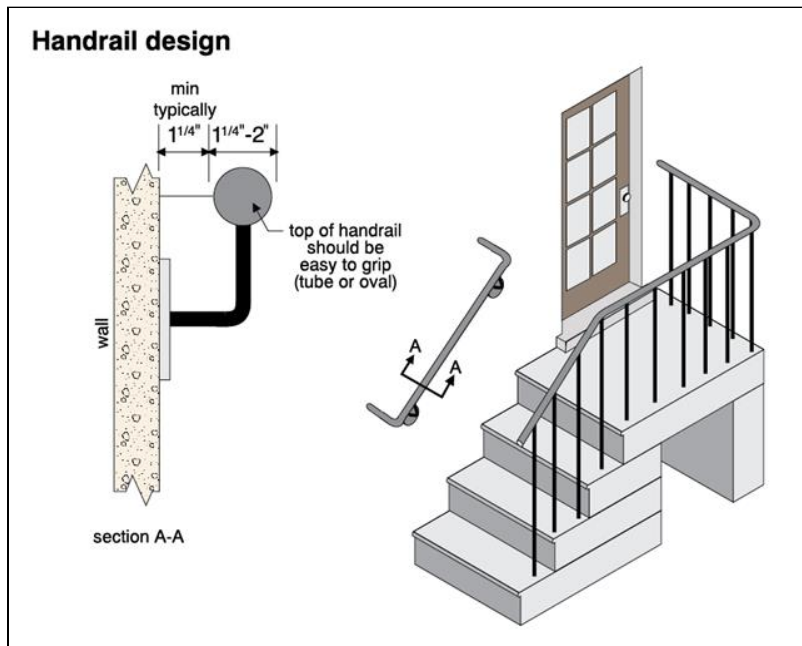

3.5 Item 4(Picture)

**3.5 (3)** The support posts for the deck are 4x4s. This was common when this home was built. 6x6 posts are now recommended for structural support for decks. I would recommend monitoring posts annually and at the first sign of posts leaning, strongly recommend a qualified contractor repair or replace post to ensure structural integrity of the deck. This is for your information.

**3.6** (1) Common settlement crack(s) were noted at the concrete drive. This is not a tripping hazard as yet at this time. I also do not see these small cracks as an indication of a structural issue. Further deterioration and/or settlement can occur to the driveway via water intrusion if not repaired. Recommend repairs via a masonry caulk as needed then monitor annually. Here is a link for [Sealing Concrete Cracks](#)

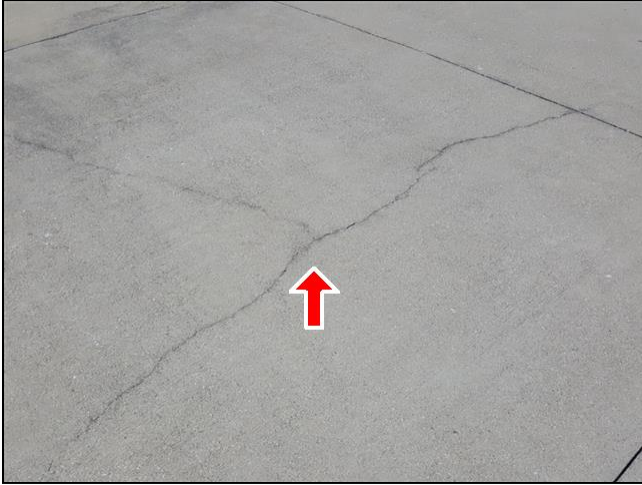

3.6 Item 1(Picture)

3.6 Item 2(Picture)

**3.6** (2) The front walkway has settled where it butts up to the driveway creating a possible tripping hazard. I do not see this as an indication of a structural issue. However, for safety and to prevent a tripping hazard and a fall or injury from occurring, recommend a qualified masonry contractor repair as needed.



3.6 Item 3(Picture)

3.8 The grade of soil naturally flows towards the rear left side of the home. Cannot determine if this will cause water pooling against the foundation of the home. Recommend this be monitored when heavy rains are experienced. If water does pool in this area then installing a french drain or a swale by a qualified contractor to prevent water impingement against the foundation wall is strongly recommended. This will avoid moisture and water intrusion in the crawlspace and prevent possible settling of the foundation perimeter of the home.

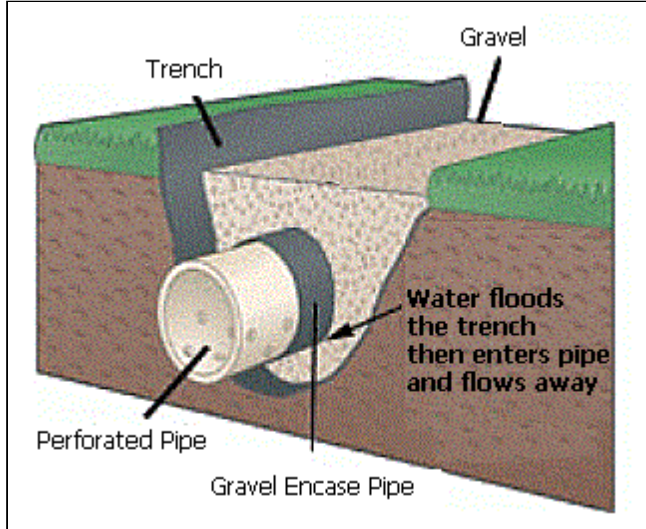

3.8 Item 1(Picture)

3.8 Item 2(Picture)

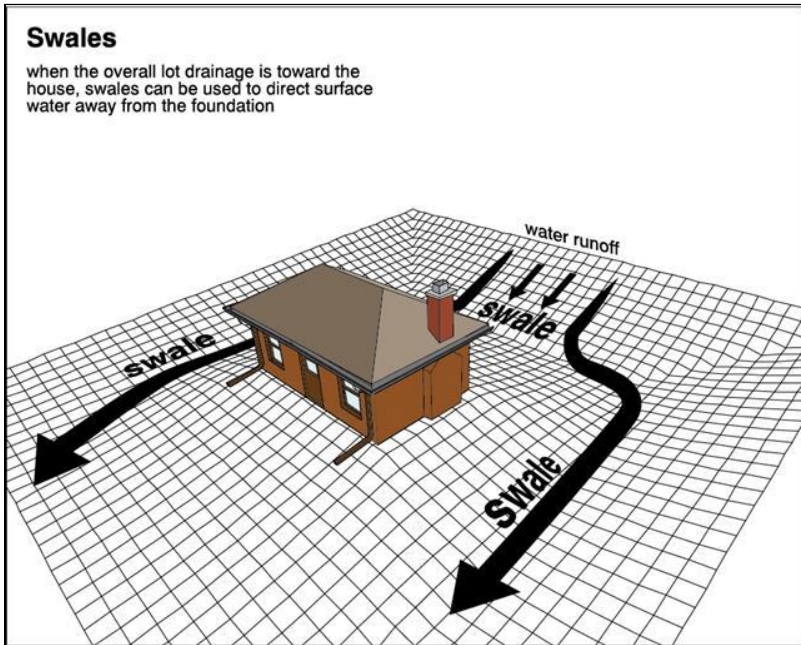

3.8 Item 3(Picture)

**3.9** The shrub at the rear left corner of the home could disrupt gutter, cause mechanical damage to the exterior of home or influence the foundation over time. It would be wise to consider trimming or removal of the shrub. Also recommend that shrubs or bushes be kept neatly trimmed and away from the exterior of home, a minimum of six inches to allow proper venting.



3.9 Item 1(Picture)

**3.10** To reduce the risk of contamination of the supply water, installation of anti-siphon devices on exterior faucets is recommended.

**3.11** The exterior outlet(s) of the home are GFCI protected however when tripped you need to reset them at the panel box at the appropriate breaker No. 25. This is for your information.

---

The exterior of the home was inspected and reported on with the above information. While the inspector makes every effort to find all areas of concern, some areas can go unnoticed. Please be aware that the inspector has your best interest in mind. Any repair items mentioned in this report should be considered before purchase. It is recommended that qualified contractors be used in your further inspection or repair issues as it relates to the comments in this inspection report.

## 4. Garage/Carport

The home inspector shall observe: Exterior and interior walls and ceilings, floors, windows, doors, roof, and foundation; Electrical system and components; Plumbing system and components; Garage door operators; The home inspector shall: Describe type and material of doors, exterior and interior walls, and roof; Operate garage doors manually or by using permanently installed controls for any garage door operator; Report whether or not any garage door operator will automatically reverse or stop when meeting reasonable resistance during closing; The home inspector is not required to observe: Garage door operator remote control transmitters; The home inspector is not required to: Move personal items, panels, furniture, or equipment that obstructs access or visibility.



### Styles & Materials

**Garage Insulation:**

NONE

**Garage Door Type / Material:**

Two automatic  
Metal  
Insulated

**Auto-opener Manufacturer:**

LIFT-MASTER  
1/2 HORSEPOWER

**Ceiling Materials:**

Drywall

**Wall Material:**

Drywall  
and  
Poured Concrete

**Floor Material/Covering(s):**

Concrete

**Door to Interior:**

Metal

**Door to Exterior:**

NONE

**Window Types:**

NONE

		IN	NI	NP	C	RR
4.0	Garage Ceiling	•				
4.1	Garage Walls	•				
4.2	Garage Floor				•	
4.3	Garage Door/Operators (Report whether or not doors will reverse when met with resistance)	•				
4.4	Occupant Door from Garage to inside home	•				
4.5	Steps, Stairways, Balconies and Railings					•
4.6	Connected Devices and Fixtures (Observed from a representative number operation of ceiling fans, lighting fixtures, switches and receptacles)	•				
4.7	General Info	•				

IN= Inspected, NI= Not Inspected, NP= Not Present, C= Conditional, RR= Repair or Replace

**IN NI NP C RR**



**Comments:**

**4.2** The garage flooring has typical cracks in areas highlighted in photos. These cracks do not appear significant and seem typical. Cracks that are usually 1/8 inch or wider are need for concern. The cracks are usually the result of shrinkage and/or settling of the slab. Recommend these cracks be sealed then apply an epoxy coating on the floor to ensure water intrusion does not occur. It is recommended that you monitor annually after repairs. If these cracks should reoccur a masonry contractor who is familiar with foundation repair should be consulted. [Caulk for Concrete Cracks](#)



4.2 Item 1(Picture)

**4.3** The garage door(s) will reverse when met with resistance.

The sensors are in place for garage door(s) and will reverse the door when interrupted.

**4.4** Recommend the door between the garage and the interior of the house be equipped with an auto-closer device to prevent automobile fumes from entering the house. This is for your information.

**4.5** [The guard rail and stair case rails in the garage are loose, unstable and not secured properly. This is extremely dangerous and is a major safety concern. It may fail under a medium or heavy force or if someone was pushed against or was leaning on the railing. For your safety it should be strengthened and secured. Recommend a qualified contractor repair as needed before closing.](#)



4.5 Item 1(Picture)

**4.6** (1) The garage outlets are GFCI protected. This is for your information.

**4.6** (2) If a refrigerator is installed in the garage it will be connected to a GFCI outlet. If the outlets are tripped the refrigerator will be turned off. This is for your information.

**4.7** Note: Limited Inspection of the garage was performed due to excessive personal property, unable to view most of the walls, slab and access switches and outlets. Recommend further inspection of these item(s) / areas prior to closing.



4.7 Item 1(Picture)



4.7 Item 2(Picture)



4.7 Item 3(Picture)

---

The garage of the home was inspected and reported on with the above information. While the inspector makes every effort to find all areas of concern, some areas can go unnoticed. Please be aware that the inspector has your best interest in mind. Any repair items mentioned in this report should be considered before purchase. It is recommended that qualified contractors be used in your further inspection or repair issues as it relates to the comments in this inspection report.

**5. Kitchen / Components and Appliances**



The home inspector shall observe and operate the basic functions of the following kitchen appliances: Permanently installed dishwasher, through its normal cycle; Range, cook top, and permanently installed oven; Garbage disposal; Ventilation equipment or range hood; and Permanently installed microwave oven; Observe kitchen cabinets and countertops; Walls, ceiling, and floors; Interior water supply and distribution system, including: piping materials, supports, and insulation; fixtures and faucets; functional flow; leaks; and cross connections; Interior drain, waste, and vent system, including: traps; drain, waste, and vent piping; piping supports and pipe insulation; leaks; and functional drainage; Operate all plumbing fixtures, The operation of a representative number of installed ceiling fans, lighting fixtures, switches and receptacles; The operation of ground fault circuit interrupters; The polarity and grounding of all receptacles within six feet of interior plumbing fixtures, The home inspector is not required to observe: Clocks, timers, self-cleaning oven function, or thermostats for calibration or automatic operation; Non built-in appliances; Paint, wallpaper, and other finish treatments on the interior walls, ceilings, and floors; Carpeting; or Draperies, blinds, or other window treatments. The home inspector is not required to operate: Any water shut off valves; Appliances in use; or Any appliance that is shut down or otherwise inoperable.



washer dryer room

**Styles & Materials**

**Dishwasher Brand:**

WHIRLPOOL

Serial # Model# : #F30127552

#WDF510PAYW6

**Disposer Brand:**

NONE

**Range/Oven Fuel Type and Brand:**

ELECTRIC

GENERAL ELECTRIC

Serial # Model # :

#VH253246Q #JS760SL1SS

**Built in Microwave/Exhaust/Rangehood Vent Type and Brand:**

NONE

**Refrigerator Brand:**

SAMSUNG

**Cabinetry:**

Melamine

Serial # Model # Year # :  
 #43DU4HBS400009D #RF265ABWP #2009

**Countertop:**  
 Wood with laminate top

**Washer and Dryer:**  
 NOT INSPECTED

**Clothes Dryer Vent Material:**  
 Flexible Metal

**Dryer Power Source:**  
 240 Electric

		IN	NI	NP	C	RR
5.0	Plumbing Water Supply, Faucets, Shutoffs, and Fixtures	•				
5.1	Plumbing Drain and Vent Systems				•	
5.2	Dishwasher	•				
5.3	Ranges/Ovens/Cooktops	•				
5.4	Refrigerator	•				
5.5	Pantry/Closet Doors					•
5.6	Counters and a representative number of Cabinets	•				
5.7	Outlets, GFCI (Ground Fault Circuit Interrupters), Wall Switches and Fixtures (Lights and Ceiling Fans)	•				
5.8	Clothes Dryer Vent Piping					•

IN= Inspected, NI= Not Inspected, NP= Not Present, C= Conditional, RR= Repair or Replace

IN NI NP C RR

**Comments:**

**5.1** The disposal drain line is incorrectly pitched to the sink drain line from the disposal unit under the sink in the kitchen. This can cause the drain line to clog. Recommend a qualified plumber correct as needed.

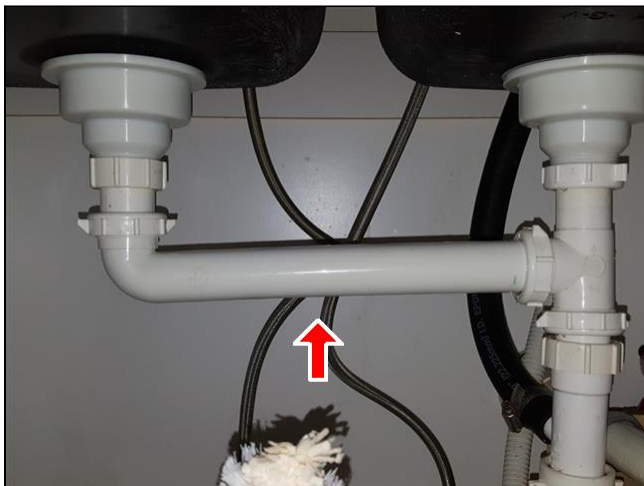

5.1 Item 1(Picture)

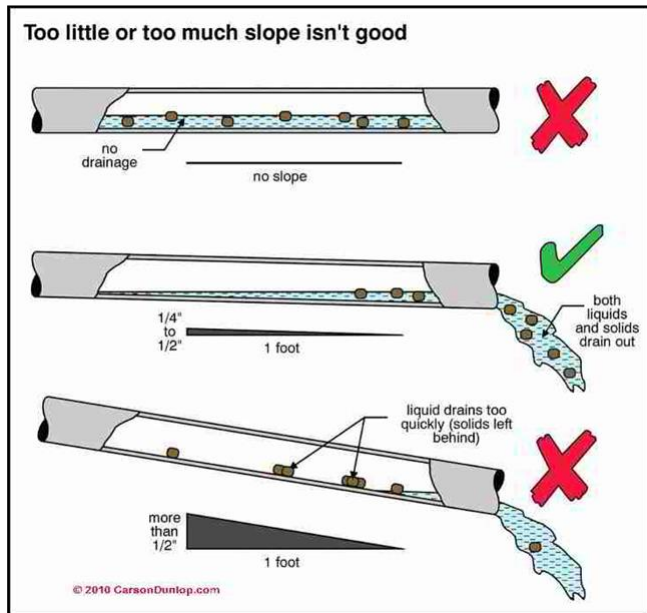

5.1 Item 2(Picture)

5.5 The kitchen pantry door hits the door jamb at the top and does not close shut. This is a maintenance issue. Sometimes correcting the door opening can require door trim to be removed and painting touch up, and/or door hinges may need reseating to ensure correct closure of door. Recommend a general contractor repair as needed.



5.5 Item 1(Picture)

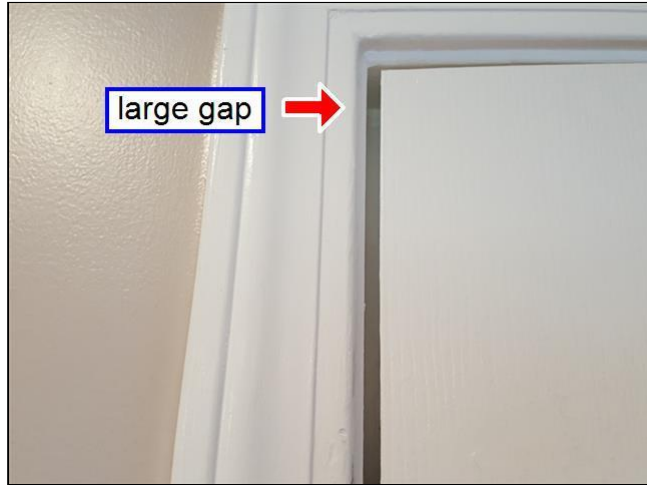

5.5 Item 2(Picture) top of frame

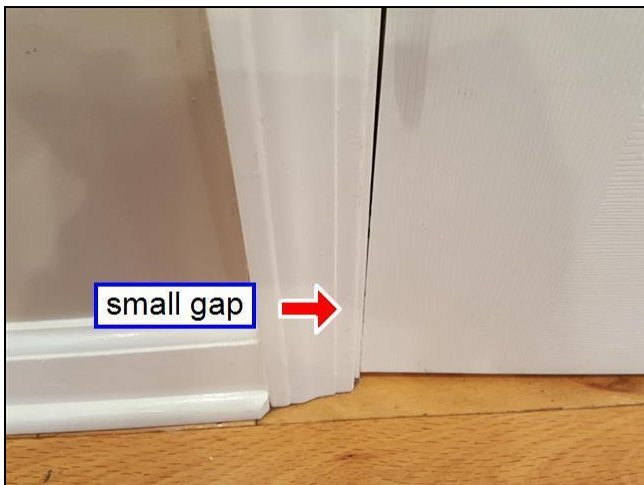

5.5 Item 3(Picture) bottom of frame

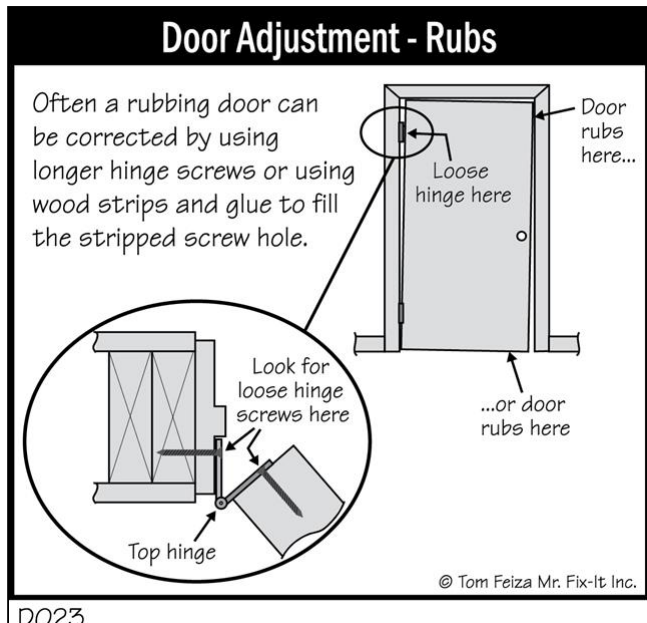

5.5 Item 4(Picture)

5.7 (1) The outlets in the kitchen are GFCI protected. This is for your information.

5.7 (2) I could not identify or inspect the outlet for refrigerator. I do not move refrigerators in order to access the outlet.

5.8 (1) The exterior port for the dryer vent pipe is located at the rear left side of the home. (see photo for location) This is for your information.



5.8 Item 1(Picture)

5.8 (2) The dryer vent piping is kinked. Damaged or bends in piping can cause an obstruction of lint that has a possibility to create a fire hazard. Recommend replacing flexible line prior to using dryer.



5.8 Item 2(Picture)

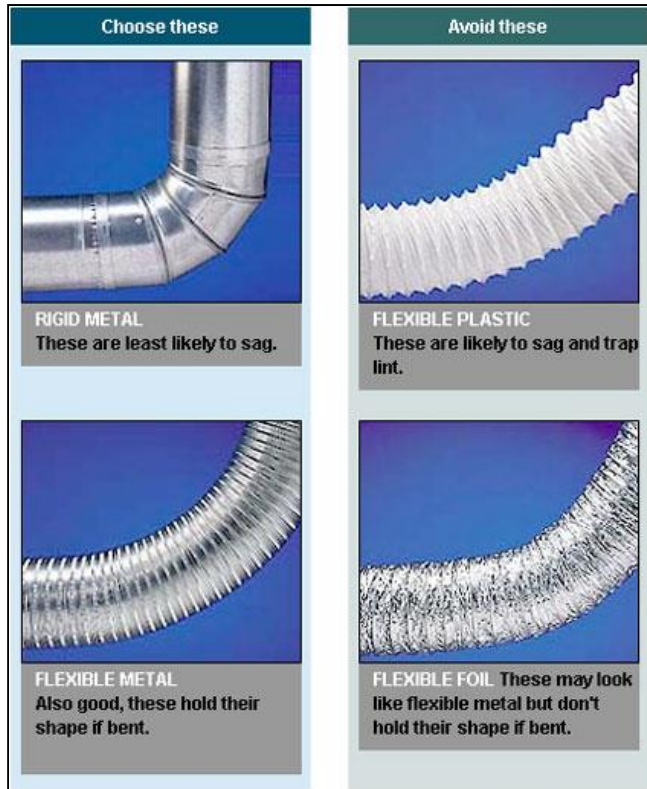

5.8 Item 3(Picture)

The Kitchen area of the home was inspected and reported on with the above information. While the inspector makes every effort to find all areas of concern, some areas can go unnoticed. Please be aware that the inspector has your best interest in mind. Any repair items mentioned in this report should be considered before purchase. It is recommended that qualified contractors be used in your further inspection or repair issues as it relates to the comments in this inspection report.

## 6. Rooms



The home inspector shall observe: Walls, ceiling, and floors; Steps, stairways, balconies, and railings; Counters and a representative number of installed cabinets; and A representative number of doors and windows. The home inspector shall: Operate a representative number of windows and interior doors; The operation of a representative number of installed ceiling fans, lighting fixtures, switches and receptacles; and Report signs of abnormal or harmful water penetration into the building or signs of abnormal or harmful condensation on building components. The home inspector is not required to observe: Paint, wallpaper, and other finish treatments on the interior walls, ceilings, and floors; Carpeting; or Draperies, blinds, or other window treatments. The home inspector is not required to: Move personal items, panels, furniture, or equipment that obstructs access or visibility.



dining room



living room



formal dining room



master bedroom



2nd bedroom



3rd bedroom

## Styles & Materials

**Ceiling Materials:**

Drywall

**Wall Material:**

Drywall

**Floor Covering(s):**

Hardwood  
and  
Tile



**Interior Doors:**

Hollow core  
Wood

**Window Types:**

Single-hung, Tilt feature, Thermal/Insulated

		IN	NI	NP	C	RR
6.0	Ceilings	•				
6.1	Walls	•				
6.2	Floors	•				
6.3	Steps, Stairways and Railings			•		
6.4	Doors (Representative number)	•				
6.5	Windows (Representative number)	•				
6.6	Closets					•
6.7	Outlets, GFCI, Wall Switches and Fixtures (Lights and Ceiling Fans)					•
6.8	Smoke and Carbon Monoxide Detectors					•
6.9	General Notes	•				

IN= Inspected, NI= Not Inspected, NP= Not Present, C= Conditional, RR= Repair or Replace

**IN NI NP C RR**

**Comments:**

**6.0** (1) There are seams in the drywall ceiling in the living room which are loose. This is a cosmetic issue. This is common and often caused by moisture, changing temperature, or framing shrinkage due to lack of ventilation of vaulted ceilings. Repairs are recommended to improve the ceilings appearance. This is for your information.



6.0 Item 1(Picture)

**6.0** (2) The drywall has a vertical shrinkage/settlement crack(s) where the ceiling meets in the dining room. Most minor cracking is due to shrinkage of construction materials. The crack is considered to be cosmetic and a small repair issue for your information. Recommend prep prime and paint as needed.



6.0 Item 2(Picture)

**6.6** The mirrored closet door in the 3rd bedroom is cracked. This is a potential safety issue as a person or child could be injured or be cut. Recommend replacement as needed by a general contractor.



6.6 Item 1(Picture)

6.7 The outlet(s) where indicated in the photo(s) are loose at the wall or in the outlet box. Electrical issues are considered a hazard until repaired. This is a safety issue that needs to be corrected due to an electric shock or fire from loose connections could occur if not repaired. Recommend a qualified licensed electrical contractor correct as needed.



6.7 Item 1(Picture) dining room



6.7 Item 2(Picture) kitchen hallway



6.7 Item 3(Picture) living room



6.7 Item 4(Picture) washer dryer room

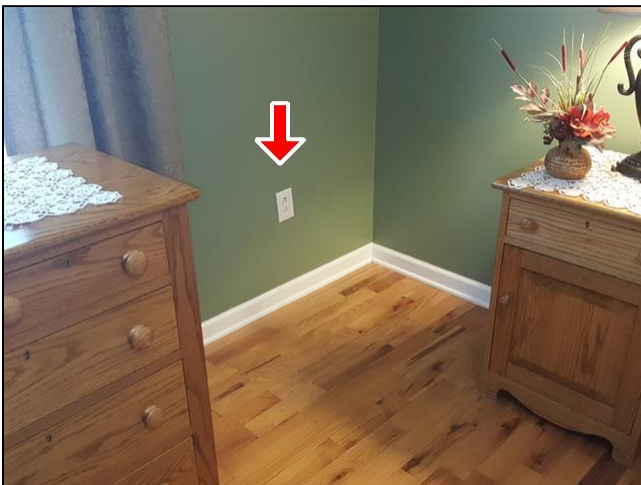

6.7 Item 5(Picture) master bedroom

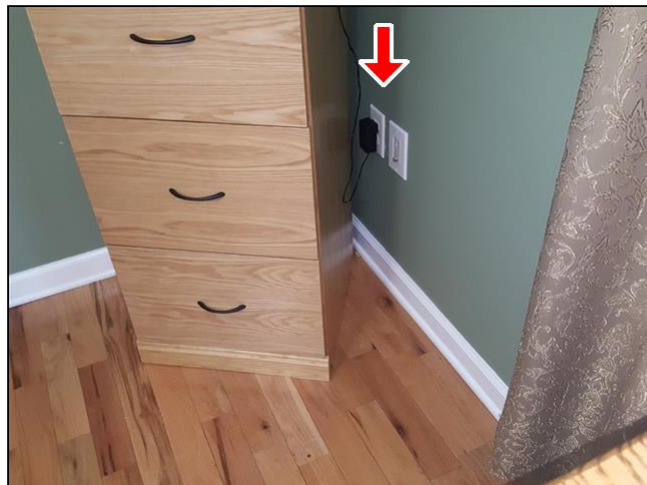

6.7 Item 6(Picture) master bedroom



6.7 Item 7(Picture) hallway



6.7 Item 8(Picture) 3rd bedroom

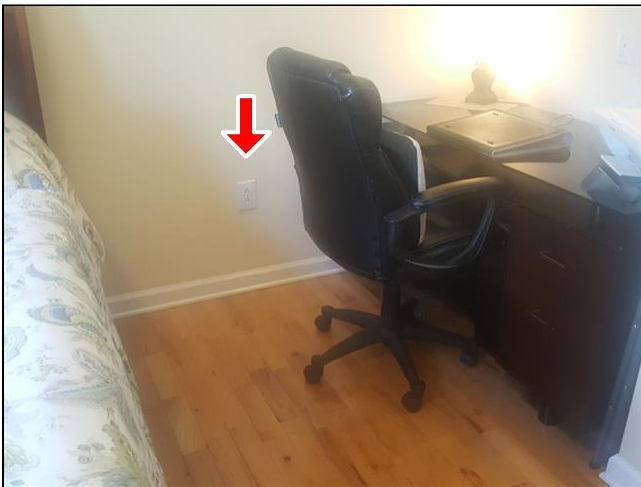

6.7 Item 9(Picture) 3rd bedroom



6.7 Item 10(Picture) 2nd bedroom

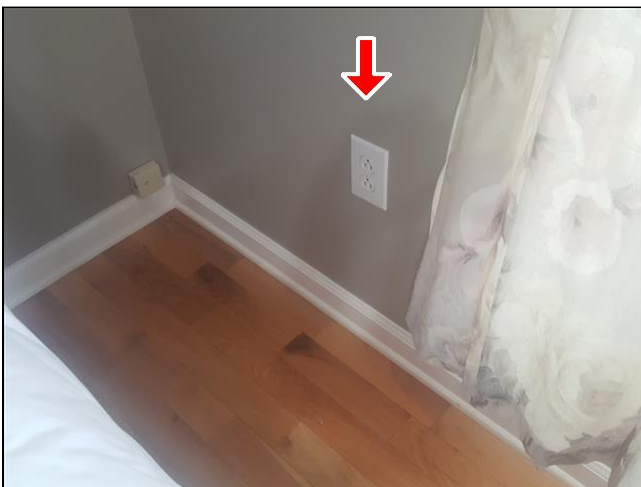

6.7 Item 11(Picture) 2nd bedroom

**6.8 (1)** Testing of smoke and CO detectors is not part of a home inspection. We do not want to create a false alarm. All detectors in the home exhibit the active green light which indicates they are on and functioning. Recommend the smoke detectors be tested at common hallway to bedrooms upon moving in to home. Note: If the smoke/CO alarm is 10 years old or older, recommend replacement. Ensure the smoke alarm is a photoelectric type. Here is a link explaining type of alarm to use by the [Dept. of Fire and Emergency Services](#)



6.8 Item 1(Picture)

**6.8 (2)** The smoke detectors are hanging loose at the ceiling in the 2nd Bedroom. These may not be working due to contacts are not connected correctly. It is also placing strain at the connections which could result in detectors not functioning. Recommend these be secured to the ceiling prior to moving in, then tested to ensure they are working.



6.8 Item 2(Picture)

**6.9** The house is lived in and the furnishings or items prevented a complete inspection of the interior of the home, receptacles, closets, walls and floors in some areas. These areas should be examined before closing to verify that there is no damage that was hidden by the furnishings.

---

The interior of the home was inspected and reported on with the above information. While the inspector makes every effort to find all areas of concern, some areas can go unnoticed. The inspection did not involve moving furniture and inspecting behind furniture, area rugs or areas obstructed from view. Please be aware that the inspector has your best interest in mind. Any repair items mentioned in this report should be considered before purchase. It is recommended that qualified contractors be used in your further inspection or repair issues as it relates to the comments in this inspection report.

7. Bathroom and Components



The home inspector shall observe: Walls, ceiling, and floors; Counters and a representative number of installed cabinets; Interior water supply and distribution system, including: piping materials, supports, and insulation; fixtures and faucets; functional flow; leaks; and cross connections; Interior drain, waste, and vent system, including: traps; drain, waste, and vent piping; piping supports and pipe insulation; leaks; and functional drainage; The home inspector shall operate all plumbing fixtures, except where the flow end of the faucet is connected to an appliance; and Report signs of abnormal or harmful water penetration into the building or signs of abnormal or harmful condensation on building components; The operation of a representative number of installed ceiling fans, lighting fixtures, switches and receptacles. The polarity and grounding of all receptacles within six feet of interior plumbing fixtures. The home inspector is not required to: State the effectiveness of anti-siphon devices; or Observe the system for proper sizing, design, or use of proper materials; Paint, wallpaper, and other finish treatments on the interior walls, ceilings, and floors; Carpeting; or Draperies, blinds, or other window treatments; The home inspector is not required to operate: Any water shut off valves; and Move personal items, panels, furniture, or equipment that obstructs access or visibility.

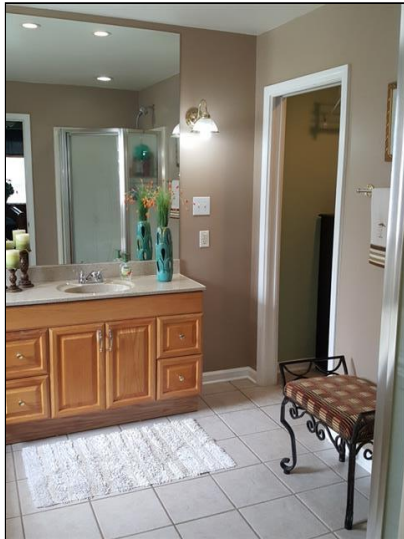

master bathroom



master bathroom

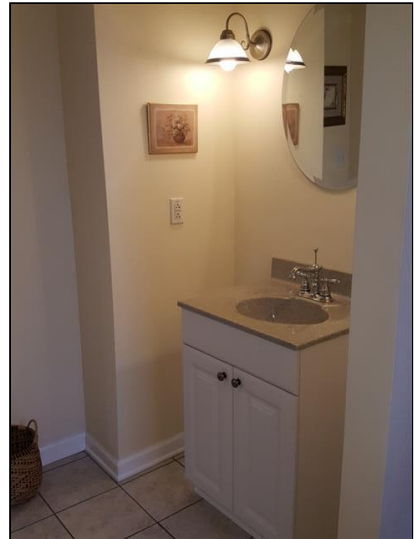

2nd bathroom



2nd bathroom



2nd bathroom



half bath

Styles & Materials

Floor Covering(s):

Tile

Wall Material/Coverings:

Drywall

Window Types:

Fixed and Single Hung-Tilt Feature, Thermal/Insulated

**Exhaust Fans:**

Fan with light

		IN	NI	NP	C	RR
7.0	Floor	•				
7.1	Counters and Cabinets	•				
7.2	Doors (Representative number)	•				
7.3	Windows	•				
7.4	Plumbing Water Supply, Shutoffs, Faucets, and Fixtures					•
7.5	Plumbing Drain and Vent Systems	•				
7.6	Outlets, GFCI (Ground Fault Circuit Interupters), Wall Switches and Fixtures					•
7.7	Bath(s) and/or Shower(s) - walls,enclosure, and doors	•				
7.8	Jacuzzi Tub					•
7.9	Toilet(s)	•				
7.10	Exhaust fan	•				

IN= Inspected, NI= Not Inspected, NP= Not Present, C= Conditional, RR= Repair or Replace

**IN NI NP C RR**

**Comments:**

**7.4 (1)** The control knob on the cold water faucet leaks at the jacuzzi when moved abruptly in the master bathroom. New seals maybe needed. Recommend a licensed plumber repair or replace as needed.



7.4 Item 1(Picture)

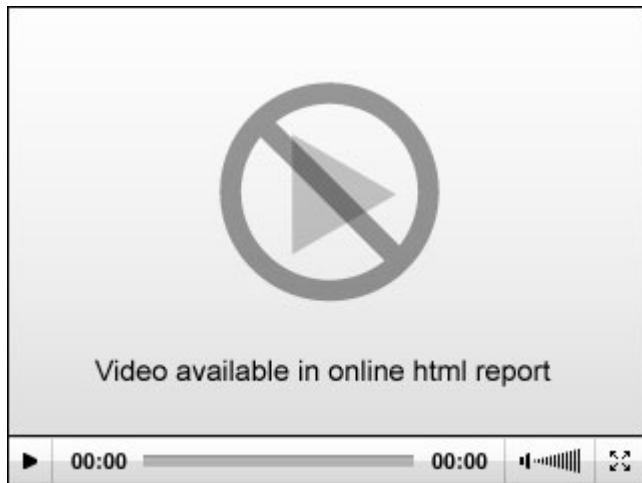

7.4 Item 2(Video)



7.4 (2) The drain control stopper is not connected at the sink and does not function in the 2nd bathroom (closest to 2nd bedroom). Recommend correcting to allow easy use of the drain lever and to ensure it functions properly. Repair or correct as needed.



7.4 Item 3(Picture) left side closest to 2nd bedroom

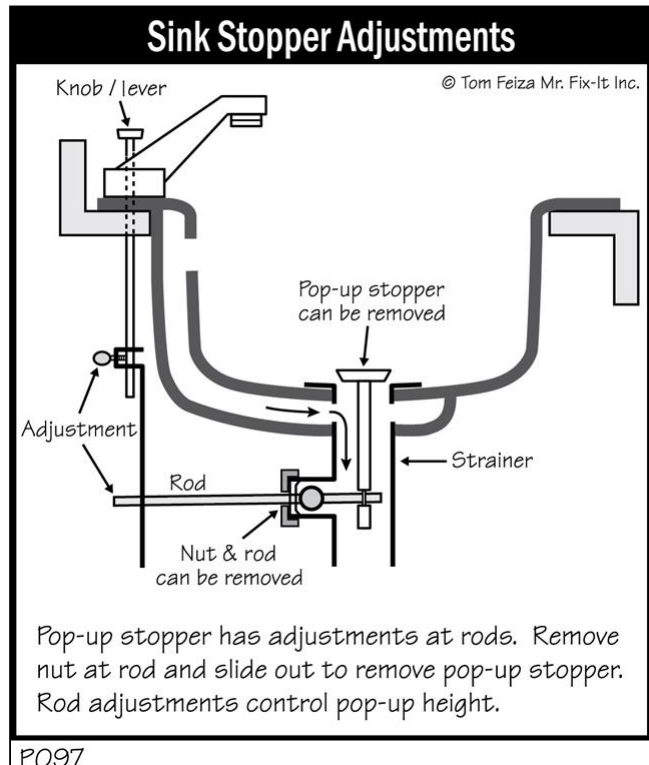

7.4 Item 4(Picture)

7.6 (1) The outlets in all the bathrooms are GFCI protected. This is for your information.

7.6 (2) The outlet(s) in the half bath are GFCI protected and the reset switch is located in the Master bathroom. This is for your information.

7.6 (3) The outlet(s) in the 2nd bathroom where indicated in the photo(s) is loose in the wall or at the outlet box. Electrical issues are considered a hazard until repaired. This is a safety issue that needs to be corrected due to an electric shock or fire from loose connections could occur if not repaired. Recommend a qualified licensed electrical contractor correct as needed.



7.6 Item 1(Picture)

**7.8** (1) The jacuzzi tub worked properly at the time of the inspection in the master bathroom and the GFCI outlet did trip when tested. This is for your information.

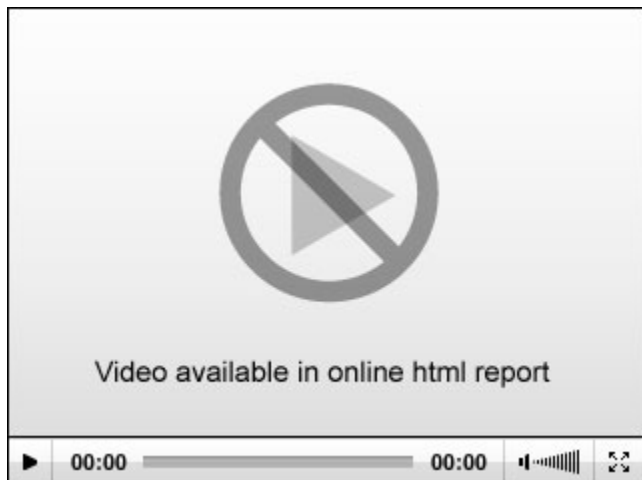

7.8 Item 1(Video)

**7.8** (2) Access to the pump and drain lines for the jacuzzi tub was not present or could not be found. Could not check for leaks at the pipes or pump. Check with the owner for location. If one is not found would recommend an access point be installed in the event servicing of the pump or pipes need to be worked on.

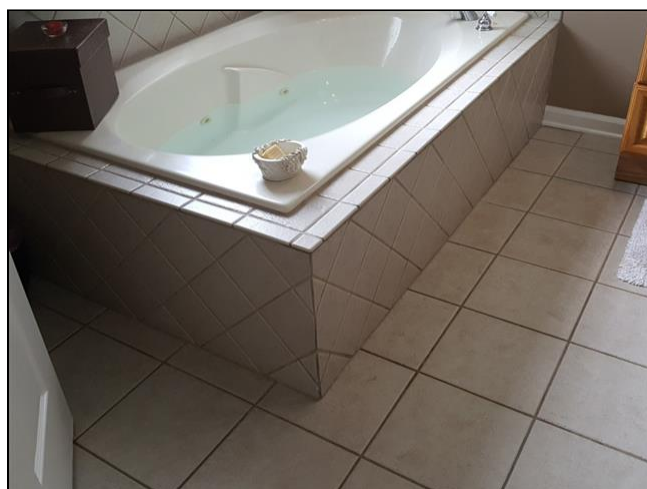

7.8 Item 2(Picture)

7.8 (3) The on/off switch for the operation of the pump for the jacuzzi does not function at the tub. The unit was operated at the wall switch in the bathroom. Recommend an electrician repair or replace switch as needed for ease of use.

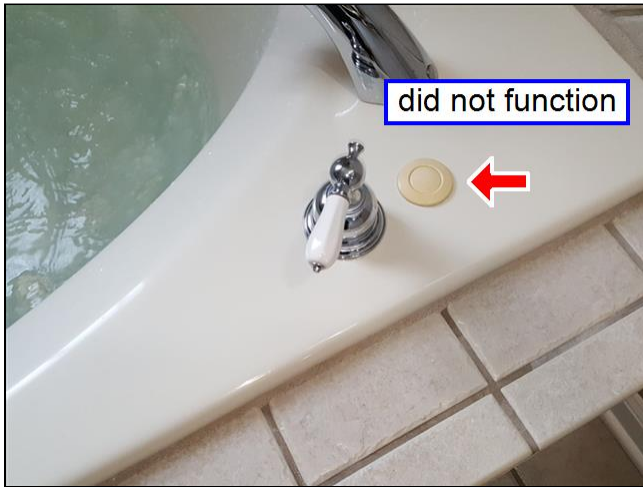

7.8 Item 3(Picture)

7.8 Item 4(Picture)

The bathroom of the home was inspected and reported on with the above information. While the inspector makes every effort to find all areas of concern, some areas can go unnoticed. Please be aware that the inspector has your best interest in mind. Any repair items mentioned in this report should be considered before purchase. It is recommended that qualified contractors be used in your further inspection or repair issues as it relates to the comments in this inspection report.

8. Plumbing System



The home inspector shall observe: Interior water supply and distribution system, including: piping materials, supports, and insulation; fixtures and faucets; functional flow; leaks; and cross connections; Interior drain, waste, and vent system, including: traps; drain, waste, and vent piping; piping supports and pipe insulation; leaks; and functional drainage; Hot water systems including: water heating equipment; normal operating controls; automatic safety controls; and chimneys, flues, and vents; Fuel storage and distribution systems including: interior fuel storage equipment, supply piping, venting, and supports; The home inspector shall describe: Water supply and distribution piping materials; Drain, waste, and vent piping materials; and Location of main water supply shutoff device; Type and capacity of Water heating equipment;. The home inspector shall operate all plumbing fixtures, including their faucets and all exterior faucets attached to the house, except where the flow end of the faucet is connected to an appliance. The home inspector is not required to: State the effectiveness of anti-siphon devices; Determine whether water supply and waste disposal systems are public or private; Operate any valve except water closet flush valves, fixture faucets, and hose faucets; Observe: Water conditioning systems; Fire and lawn sprinkler systems; On-site water supply quantity and quality; On-site waste disposal systems; Foundation irrigation systems; Swimming pools; or Observe the system for proper sizing, design, or use of proper materials; Solar water heating equipment.



left side



right side 2nd unit

Styles & Materials

**Main Water Valve Location:**

Crawlspace  
on the front wall

**Water Source:**

Public

**Plumbing Water Supply (into home):**

Copper

**Plumbing Water Distribution (inside home):**

Copper

**Plumbing Venting Line:**

PVC  
Partially Visible

**Plumbing Waste Line:**

PVC

**Washer Drain Size:**

2" Diameter

**Main Gas Valve Location:**

N/A

**Water Heater Manufacturer/Model/Age:**

AGED  
WHIRLPOOL  
Model# Serial# Year# : #E1F50RD045V  
#0221123878 #2002

**2nd Water Heater Manufacturer/Model/Age:**

AGED  
WHIRLPOOL  
Model# Serial# : #E1F50RD045V  
#0221104556 #2002

**Water Heater Power Source/Capacity/Location:**

Electric  
50 Gallon (2-3 people)  
Two units  
Washer/Dryer Room

		IN	NI	NP	C	RR
8.0	Plumbing Drain, Waste Pipes and Vent Systems	•				
8.1	Plumbing Water Supply and Distribution Systems	•				
8.2	Hot Water Systems and Controls	•				
8.3	Pipes and Drainage (Hot Water Systems)	•				
8.4	Main Water Supply Pipe and Shut-off Device (Describe location)	•				
8.5	Sump Pump			•		

IN= Inspected, NI= Not Inspected, NP= Not Present, C= Conditional, RR= Repair or Replace

**IN NI NP C RR**

**Comments:**

**8.0** The sewer clean out cap is located at the front left side of the home. This is for your information.



8.0 Item 1(Picture)

**8.1** (1) The water pressure over-all passed "functional flow" in the home. This is determined by running water at the sinks in the bathrooms, kitchen and shower while the toilet is being flushed. If the shower spray remains, it passes functional flow. This is for your information.

8.1 (2) Recommend insulating the water supply pipes underneath in the crawlspace (hot and cold) to ensure pipes do not freeze in winter which may cause a serious plumbing leak in the crawlspace, and to prevent heat loss of water when hot water is flowing into home. This will improve efficiency. This is for your information.



8.1 Item 1(Picture)

8.1 Item 2(Picture)

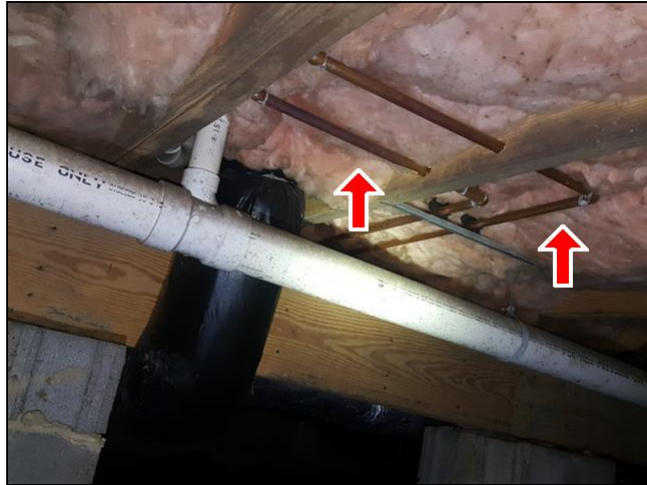

8.1 Item 3(Picture)

8.1 Item 4(Picture)

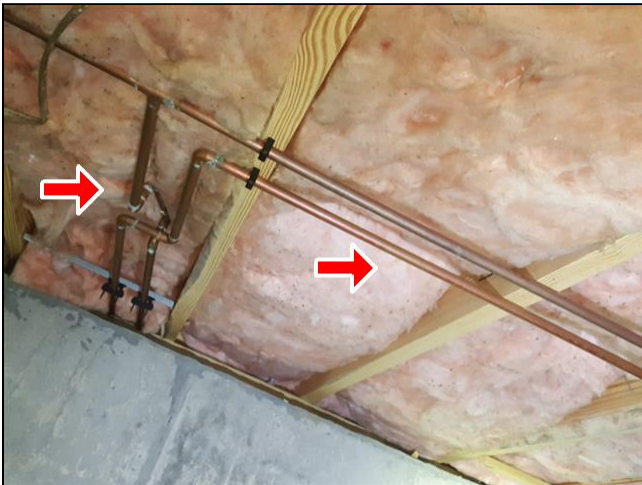

8.1 Item 5(Picture)

**8.2 (1)** The water heaters are at or nearing the end of there design life. The normal life expectancy of a water heater is between 12-16 years. The water heater in this home is dated 2002. You may wish to consider budgeting for a new water heater in the future. This is for your information.

**8.2 (2)** Your water heaters do not have a "Thermal Expansion tank" installed to prevent a possible leak at the TPR or "pop-off" valve. If the water pressure gets high enough it can damage valves in the plumbing fixtures, joints in the supply pipes and even the water heater. Thermal expansion always occurs in water heaters. Like most substances, water expands as it is heated. There were no visible leaks or drips at the TPR valve during the inspection. If your water heater does begin to drip or leak, then a thermal expansion tank may be needed. This is for your information.

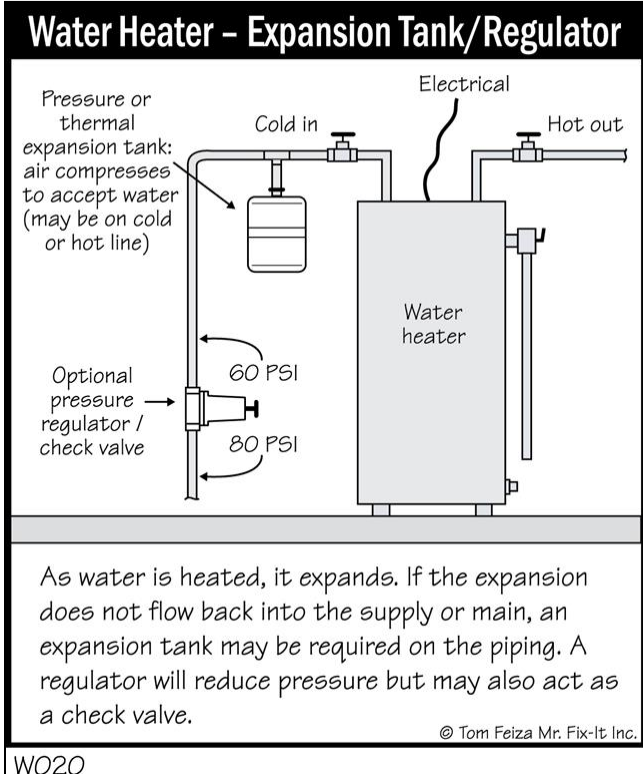

8.2 Item 1(Picture)

8.2 (3) The water heater on a finished floor has the potential to cause severe damage if a leak should develop. Consider installing a drain pan under the water heater to prevent damage to the home if a leak develops. This will allow any water leaks to safely drain without damaging the finished materials, floor or furnishings. A qualified plumber could examine and install the drainage pan and drain line, but may need to install a drain line with a trap to the current drainage system. As an inexpensive safe-guard a drain pan with a moisture alarm can easily be installed as another option. Recommend a qualified plumber make the necessary corrections if desired.



8.2 Item 2(Picture) right unit

8.2 Item 3(Picture) left unit

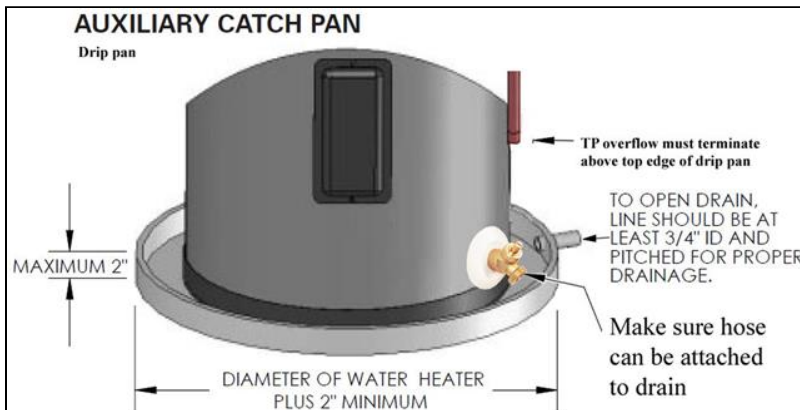

8.2 Item 4(Picture)



**8.2** (4) Your two water heaters appear to be hooked up in a parallel connection. Cannot verify for sure due to pipes are covered behind the wall. Piping in parallel allows you to use both heaters equally. It allows the system to act as one heater rather than independent. By drawing hot water out of both heaters equally, you are able to equalize the life of your heaters. The piping arrangement to and from parallel connected water heaters are extremely important to ensure the water is evenly distributed and does not take the path of least resistance (short circuit). This is for your information.

Points to consider when connecting water heaters in parallel are:

A bypass is not required as any malfunctioning tank can be isolated and removed while keeping the system operational. All tanks connected in parallel must be of the same type, model and rating to function properly. Pipe size is not limited by the tanks' inlet and outlet as headers can be increased in size. The system operates efficiently under both low and peak demands. More labor/material intensive to create balanced distribution.

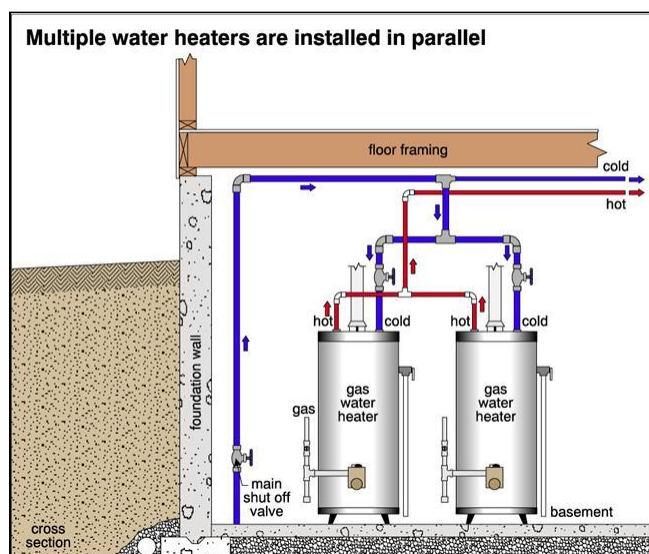

8.2 Item 5(Picture)

**8.3** (1) Could not identify or visibly see where the drainage for the TPR line for both water heaters is draining to the exterior. Recommend contacting the owner for location. The TPR drain line maybe located in the crawlspace. Water should not be dumped in a crawlspace as it can lead to mildew or mold on building materials and perhaps deterioration of the wood floor structure. The drain line(s) should exit to the exterior of the home and kept away from the foundation structure. Recommend a licensed plumber correct if needed.



8.3 Item 1(Picture) right unit

8.3 Item 2(Picture) left unit

**8.3** (2) The stop-valve has corrosion at the cold water line above the water heater in the Washer/Dryer room. There was no leaking of water at the time of the inspection. However recommend this be monitored for leakage and if it does replacement of the shutoff valve is recommended to prevent damage to the top of the water heater. Would also strongly recommend this valve be replaced when a new water heater is installed. A qualified licensed plumber should repair or correct as needed.

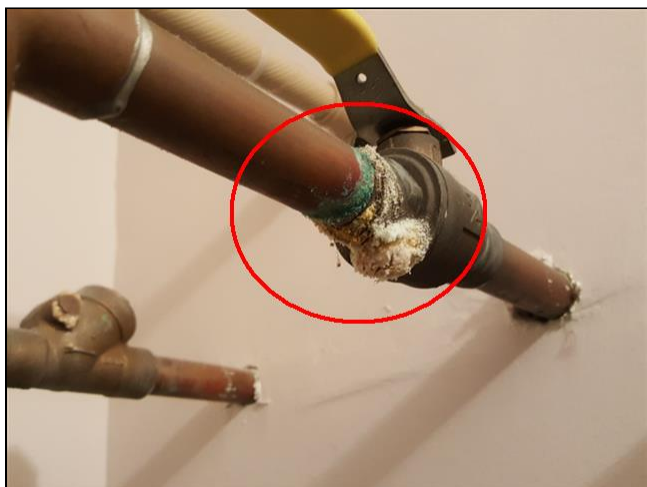

8.3 Item 3(Picture)

**8.4** (1) The main water shut off is the yellow lever located underneath in the crawlspace on the front wall under the 3rd bedroom area. This is for your information.



8.4 Item 1(Picture)

**8.4** (2) Recommend insulating the main water supply line pipe in the crawlspace due to the pipe is located in an unconditioned area. This will ensure that the pipe does not freeze in winter which may cause a serious plumbing leak and prevent costly damage to the home. This is for your information.

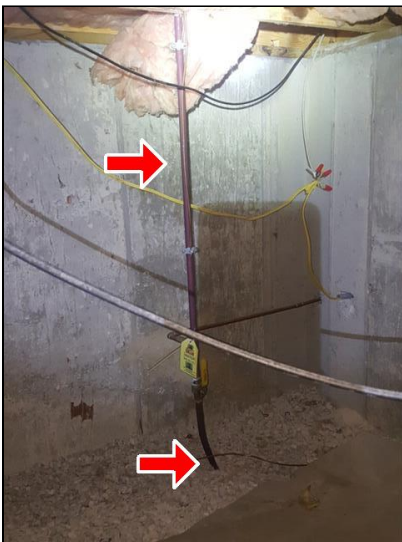

8.4 Item 2(Picture)

**8.5** You may wish to consider installing a sump pump in the crawlspace in the event that if a serious plumbing leak occurs due to freezing water pipes or an elevated water table to prevent possible damage in the crawlspace which can lead to costly repairs. This is for your information.

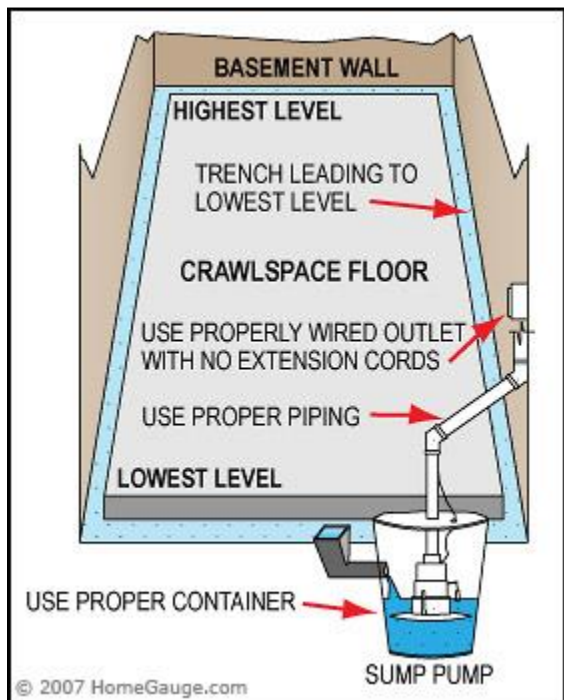

#### 8.5 Item 1(Picture)

The plumbing in the home was inspected and reported on with the above information. While the inspector makes every effort to find all areas of concern, some areas can go unnoticed. Older homes with galvanized supply lines or cast iron drain lines can be obstructed and barely working during an inspection but then fails under heavy use. If the water is turned off or not used for periods of time (like a vacant home waiting for closing) rust or deposits within the pipes can further clog the piping system. Please be aware that the inspector has your best interest in mind. Any repair items mentioned in this report should be considered before purchase. It is recommended that qualified contractors be used in your further inspection or repair issues as it relates to the comments in this inspection report.

9. Electrical System



The home inspector shall observe: Service entrance conductors; Service equipment, grounding equipment, main over current device, and main and distribution panels; Amperage and voltage ratings of the service; Branch circuit conductors, their over current devices, and the compatibility of their ampacities and voltages. The home inspector shall describe: Service amperage and voltage; Service entry conductor materials; Service type as being overhead or underground; and Location of main and distribution panels. The home inspector shall report any observed aluminum branch circuit wiring, and presence or absence of smoke detectors, and operate their test function, if accessible, except when detectors are part of a central system. The home inspector is not required to: The home inspector is not required to: Perform any procedure that may damage the property or its components or be dangerous to or adversely effect the health of the home inspector or other persons, move personal items, panels, furniture, or equipment that obstructs access or visibility; Insert any tool, probe, or testing device inside the panels; Test or operate any over current device except ground fault circuit interrupters; Dismantle any electrical device or control other than to remove the covers of the main and auxiliary distribution panels; or Observe: Low voltage systems; Security system devices, heat detectors, or carbon monoxide detectors; Telephone, security, cable TV, intercoms, or other ancillary wiring that is not a part of the primary electrical distribution system; or Built-in vacuum equipment.

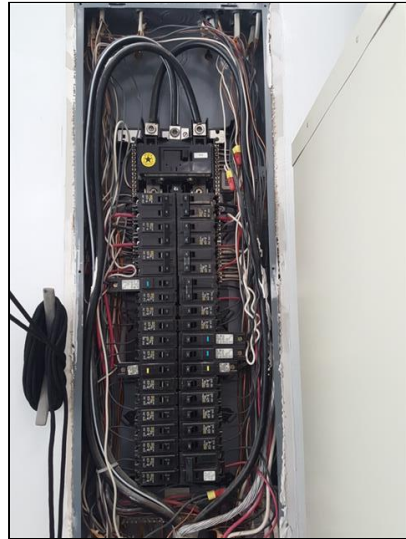

Styles & Materials

**Meter Location:** Left side of home (facing front)  
**Electrical Main Disconnect:** Panel Box and Main Meter Outside  
**Electrical Service Conductors Entry:** Below ground Aluminum 240 volts 4/0 200 Amps  
**Electric Panel Manufacturer/Type:** SQUARE D Circuit breakers  
**Panel capacity:** 200 AMP  
**Branch wire 15 and 20 AMP:** Copper

		IN	NI	NP	C	RR
9.0	Service Entrance Conductors and Meterbase	•				
9.1	Location of Main and Distribution Panels	•				
9.2	Main and Distribution Panels, Main Overcurrent Device, and Service.	•				
9.3	Branch Circuit Conductors, Overcurrent Devices and Compatability of their Amperage and Voltage	•				
9.4	Polarity and Grounding of Receptacles within 6 feet of interior plumbing fixtures, and all receptacles in garage, carport and exterior walls	•				
9.5	Breaker Operation of GFCI (Ground Fault Circuit Interrupters) AFCI (Arc Fault Circuit Interrupters)	•				

IN= Inspected, NI= Not Inspected, NP= Not Present, C= Conditional, RR= Repair or Replace

IN NI NP C RR

**Comments:**

---

**9.1** The main panel box is located at the garage.

---

The electrical system of the home was inspected and reported on with the above information. While the inspector makes every effort to find all areas of concern, some areas can go unnoticed. Outlets were not removed and the inspection was only visual. Any outlet not accessible (behind the refrigerator for example) was not inspected or accessible. Please be aware that the inspector has your best interest in mind. Any repair items mentioned in this report should be considered before purchase. It is recommended that qualified contractors be used in your further inspection or repair issues as it relates to the comments in this inspection report.

**10. Heating / Central Air Conditioning**



The home inspector shall observe permanently installed heating and cooling systems including: Cooling Equipment including; condenser and evaporative units; coils; refrigeration lines, and condensation lines; Heating equipment; Normal operating controls; Automatic safety controls; Chimneys, flues, and vents, where readily visible; Solid fuel heating devices; Heat distribution systems including fans, pumps, ducts and piping, with supports, insulation, air filters, registers, radiators, fan coil units, convectors; and the presence of an installed heat source in each room. The home inspector shall describe: Energy source; and Heating equipment and distribution type. The home inspector shall operate the systems using normal operating controls. The home inspector shall open readily openable access panels provided by the manufacturer or installer for routine homeowner maintenance. The home inspector is not required to: Operate heating/cooling systems when weather conditions or other circumstances may cause equipment damage; Operate automatic safety controls; Check the electrical current drawn by the unit; Inspect gas fired refrigeration systems, evaporative coolers, or wall or window mounted air conditioning units; Ignite or extinguish solid fuel fires; or Observe: The interior of flues; Fireplace insert flue connections; Humidifiers; or The uniformity or adequacy of heat/cool supply to the various rooms.



heat pump/left side of home



air handler/crawlspace

**Styles & Materials**

**Central Cooling Air Brand/Model/Year: Cooling Equipment Source/**

RHEEM

Serial # Model# Year# : #6160

M060213623 #RPNJ-043JAZ #2002

**Capacity/Type/Location:**

Electric

3.5 tonne

High Efficiency

Heat Pump Forced Air (also provides warm air)

left side of home

**Heat System Brand/Model/Year:**

RHEEM

Serial # Model# Year# : #T M3901

14772 #RBHK-24J18SFD #2001

**Heating Source/Capacity/Type/**

**Location:**

Electric

3.5 tonne

Air Handler

Crawlspace

**Filter Type/Size/Location:**

Disposable

(Two filters)

14x14

and

20x25

Return air grille located at

Living room

and

Hallway

**Ductwork:**

Insulated

**Fireplaces/Location:**

None

		IN	NI	NP	C	RR
10.0	Heating / Cooling Equipment					•
10.1	Filter Location/Condition					•
10.2	Electrical (heating and cooling systems)	•				
10.3	Distribution Systems (Pipes and Pumps)				•	
10.4	Ducts and Registers					•
10.5	Presence of installed heat and cooling source in each room	•				
10.6	Normal Operating Controls (Thermostat)					•
10.7	Temp Differentials (Cooling)	•				
10.8	General Notes	•				

IN= Inspected, NI= Not Inspected, NP= Not Present, C= Conditional, RR= Repair or Replace

IN NI NP C RR

**Comments:**

**10.0 (1)** Due to the season, the heat pump was tested in the cooling and emergency heat modes only. The heating mode uses the same components as the cooling mode but in the reverse cycle. To avoid possible damage to the unit due to outside temperature is above 60 degrees, the unit was not tested in the heat mode.

**10.0 (2)** Vegetation in the vicinity of the outdoor unit of the Heat Pump should be cut back to prevent obstruction of the airflow. This can cause damage to the unit via running hot ,shorten it's life expectancy, and cause it to run inefficient. Recommend removing all the vegetation surrounding the unit so that the fins are not obstructed.

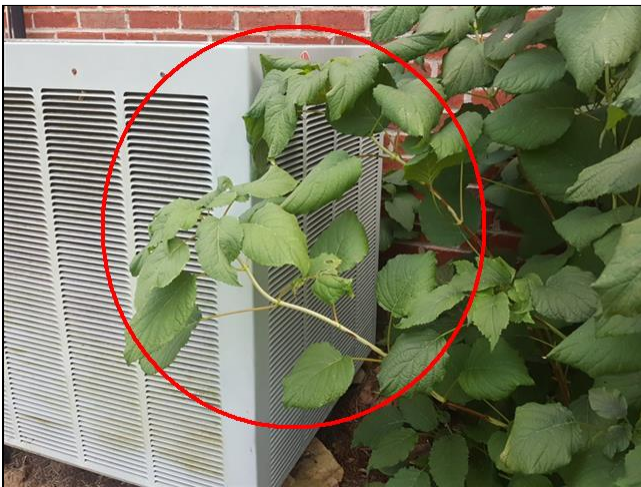

10.0 Item 1(Picture)

### AC Condenser - Clearance to Obstructions

An air conditioning condenser dissipates heat to the exterior air. There should be a 3-foot clearance at the air discharge and a 1-foot clearance where air enters the coil.

© Tom Feiza Mr. Fix-It Inc.

A013

10.0 Item 2(Picture)



**10.0** (3) The plat form foot for the Heat Pump unit is not supporting the corner of the unit correctly. Over time this may settle further causing the unit to fall of it's support which could result in a leak at the large suction line. It could also result in the unit to be unstable. Recommend a qualified HVAC contractor correct as needed to avoid this in the future.



10.0 Item 3(Picture)

**10.0** (4) This home has a heat pump and an air handler with electric heat strips (coil heating elements). An electric heat strip is a heating device that is often used to supplement a heat pump, providing additional heat when external temperatures decrease enough to prevent the furnace from maintaining the desired temperature. Electric heat strips are also referred to as electric resistance heat, auxiliary heat and emergency heat. Electric heat strips resemble the coils in toasters and are housed inside air handlers of HVAC systems. Although electric heat strips are generally utilized as a supplementary source of heat, some homes use this heating mechanism as a primary heat source. Supplementary electric heat strips usually turn on when a building's inner temperature drops at least two degrees below the temperature that is set on the thermostat. These heat strips are also triggered on if a thermostat's setting is raised too quickly.

Energy experts advise against the use of electric heat strips as they can greatly increase heating costs. Electric heat strips require high amounts of electricity and are much less efficient than traditional heat furnaces. They work at 100 percent efficiency, while heat pumps work at 200-300 percent efficiency. Suggestions to avoid using heat strips include raising the thermostat temperature by only two degrees at a time and using a programmable thermostat, which changes the temperature based on user-specified settings. This is for your information.

**10.0** (5) The refrigerant lines that enter the Air Handler are missing grommets where they enter the evaporative coil. Conditioned air is discharging into the crawlspace which can result in condensation/moisture occurring in the attic. This is inefficient, all the warm/cool air should be directed to the ducts. Recommend a qualified HVAC contractor repair as needed.



10.0 Item 4(Picture)

**10.0** (6) The Heat Pump was continuously running during the inspection period. This indicates that the unit is not running efficiently. This can cause a shorter life span on the compressor and damage to the unit. The unit may need servicing. Recommend a qualified HVAC contractor further evaluate the unit and repair as needed.

**10.1** (1) Filter location (see photo). The arrow on the filter should always point towards the blower.



10.1 Item 1(Picture) living room



10.1 Item 2(Picture) hallway

**10.1** (2) The filter in the hallway is dirty at the return register which reduces the efficiency of the HVAC system and shortens it's life. Your filter is designed to keep airborne dirt from clogging your blower. If the filter itself gets clogged, then the system cannot move enough air, and it won't perform efficiently. Filters should be checked once a month or according to manufacturers recommendations and replaced as needed. Recommend the filters be replaced now.



10.1 Item 3(Picture)

**10.2** The inside of the disconnect box was not inspected due to a lock has been placed on the box and the key was not available at time of inspection. There may be issues inside due to box not been secured to the wall. Recommend asking owner for the key and have a qualified contractor or electrician inspect before closing.



10.2 Item 1(Picture)

10.3 (1) Recommend the discharge for the condensate drain line be improved via installing a splash block and extending the drain line at the left side of the home. This will prevent water pooling near the foundation which could cause settlement of the foundation wall, soil erosion and water leakage into the crawlspace. Also to prevent possible settling of the platform for the Heat Pump. A qualified HVAC contractor is recommended for these repairs.

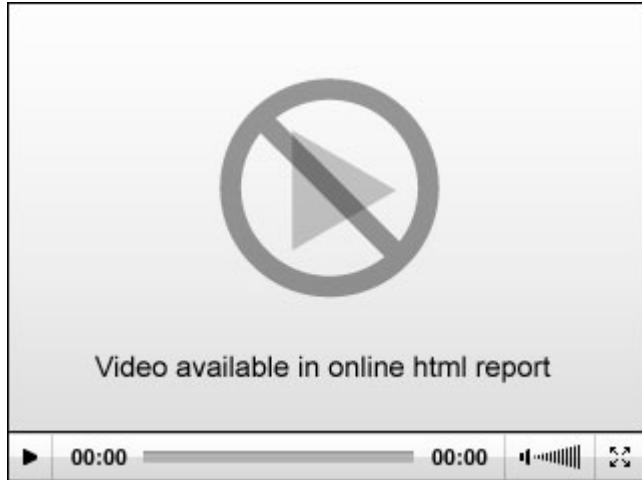
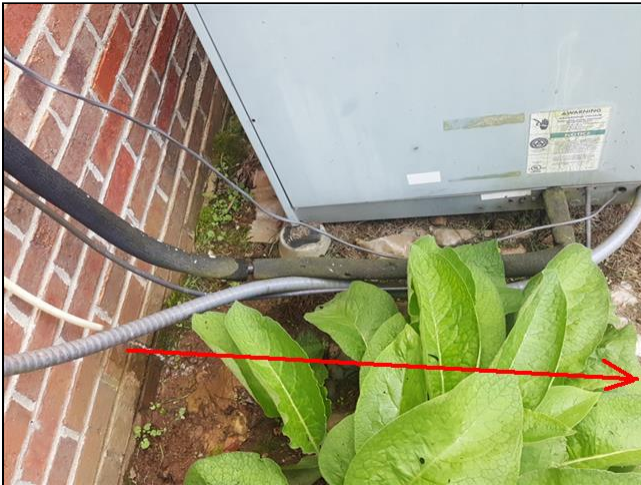

10.3 Item 1(Picture)

10.3 Item 2(Video)

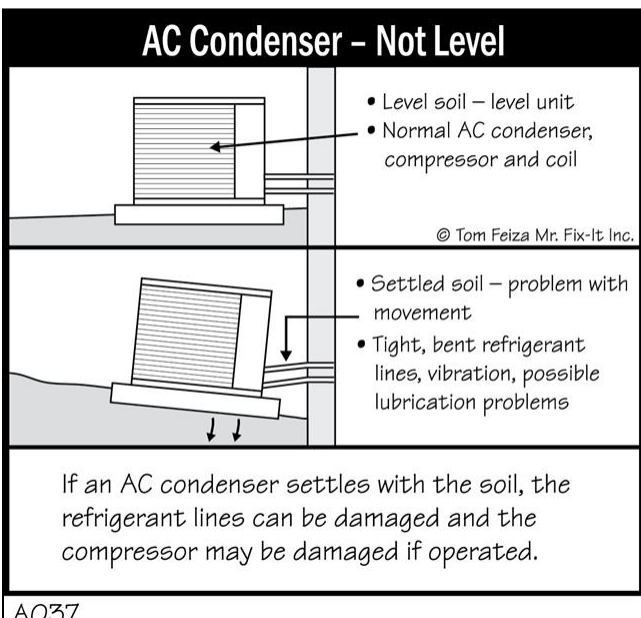

A037

10.3 Item 3(Picture)

**10.3 (2)** The foam sleeve on the large suction line for the outside Heat Pump is deteriorated and missing at areas. This can cause condensation and increased system operating costs via the unit not operating efficiently. This is a small repair. This insulation is to maintain or stabilize the temperature of the gas used in the system. The outside temperature can influence this gas and cause efficiency fluctuations of the unit. Recommend installing a new sleeve, this will help maintain efficiency of the compressor.



10.3 Item 4(Picture)

10.3 Item 5(Picture)

**10.3 (3)** The condensate pump was tested and was working at time of inspection.

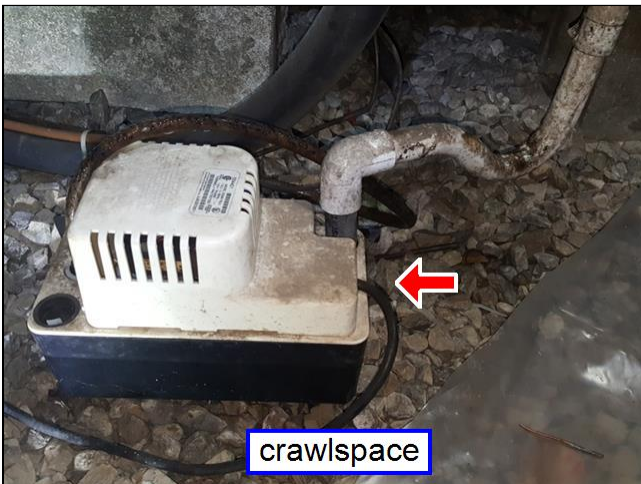

10.3 Item 6(Picture)

**10.4 (1)** Never fully close any register in a particular room(s). This can place stress on the blower fan of your unit and may shorten it's life span. It is okay to partially close registers so long as there is an airflow being pushed through. This is for your information.

Here is an article explaining [why supply and return ducts must be open and clear.](#)

**10.4 (2)** The return air duct is not sealed at the plenum at the Air Handler in the crawlspace. This is allowing unfiltered air in the crawlspace to enter the home via the blower which is allowing contaminants to enter the unit. This is a health issue. This can also cause damage to the unit and blower, increase heating/cooling costs. Recommend a qualified HVAC repair ductwork where necessary.



10.4 Item 1(Picture)

**10.6 (1)** A digital or programmable thermostat is a real energy saver up to 25% in energy bills and is more accurate. Recommend updating thermostat if desired. This is for your information.



10.6 Item 1(Picture)

**10.6 (2)** The thermostat is not functioning correctly. The reading for the inside air temperature is not working correctly. It appears to be at least 3 degrees out of balance. This can cause the unit to run longer and harder which was experienced during the inspection, (see note 10.0(6) ) it also increases the cost in running the unit. Recommend a qualified HVAC contractor further investigate and repair or replace as needed.

**10.7** The ambient air test was performed by using thermometers at the registers closest to the blower to determine if the difference in temperatures of the supply and return air are between 14 degrees and 22 degrees which indicates that the unit is cooling as intended. The supply air temperature on your system read 54 degrees, and the return air temperature was 74 degrees. This indicates the range in temperature drop is normal.



10.7 Item 1(Picture)

**10.8 (1)** During the inspection it was noted that the home was not being cooled as intended. After the heat pump was tested for emergency heating, the temperature within the home was 76 degrees. Now the system was set for cooling in the home and the thermostat was set to 69 degrees and the system was continuously running after 4 hours and the thermostat reading was 70 degrees. This indicates that the unit is not running efficiently. This could be caused by a number of conditions, some could be costly. This condition can increase cooling and heating costs and add wear and tear on the HVAC units within the home. Recommend a qualified licensed HVAC contractor further inspect and evaluate the heat pump and air handler for proper operation before closing.

**10.8 (2)** As is not uncommon for homes of this age and location, the Heat Pump and the Air Handler are relatively old. They will require a higher level of maintenance, and may be more prone to major component breakdown. Predicting the frequency or time frame for repairs on any mechanical device is virtually impossible. Check with the owner to verify when the HVAC System was serviced last. If it hasn't been serviced in the past 12 months, would **strongly** recommend having the unit serviced to ensure efficient and safe operation. If the compressor fails, or if breakdowns become chronic, replacing the entire system may be more cost-effective than continuing to undertake repairs. This is for your information.

**10.8 (3)** Due to issues found with the HVAC system and there age, strongly recommend a qualified HVAC contractor further evaluate both units, repair issues found and others that are not visible during the inspection, and have both units serviced to ensure they are operating efficiently and safely before moving into home, especially due to the Heat Pump was not tested for operation in the heating mode.

---

The heating and cooling system of this home was inspected and reported on with the above information. While the inspector makes every effort to find all areas of concern, some areas can go unnoticed. The inspection is not meant to be technically exhaustive. The inspection does not involve removal and inspection behind service door or dismantling that would otherwise reveal something only a licensed heat contractor would discover. Please be aware that the inspector has your best interest in mind. Any repair items mentioned in this report should be considered before purchase. It is recommended that qualified contractors be used in your further inspection or repair issues as it relates to the comments in this inspection report.

# Repair/ Replace General Summary



**TALON**  
Home Inspections

**Talon Home Inspections, LLC**

**4101 Tates Creek Centre Drive  
Suite 150 - PMB 312  
Lexington, KY, 40517  
(859) 447 0050**

**Customer**

Mr. Mark Stevens

**Address**

3002 Wheeler Street  
Georgetown KY 40324

The following items or discoveries indicate that these systems or components **do not function as intended** or **adversely affects the habitability of the dwelling;** or **warrants further investigation by a specialist,** or **requires subsequent observation.** This summary shall not contain recommendations for routine upkeep of a system or component to keep it in proper functioning condition or recommendations to upgrade or enhance the function or efficiency of the home. This Summary is not the entire report. The complete report may include additional information of concern to the customer. It is recommended that the customer read the complete report.

## 1. Structural Components



### 1.9 Electrical Crawlspace / Basement

#### Repair or Replace

Wires that are connected with twist caps in a crawlspace need to be placed in a junction box to prevent tampering, protect the wire connections, and for personal protection. This is a safety issue that needs to be corrected. If a leak was to occur it could result in a short then a fire in the home. Recommend a qualified licensed electrician correct as needed.



1. Structural Components



1.9 Item 1(Picture) under 3rd bedroom area

### Electrical Wire Splices Without Box

*Exposed splice*

All splices in 110/120 or higher voltage must be inside an approved metal or plastic box. This protects the splice, supports the wire, and provides fire safety.

© Tom Feiza Mr. Fix-It Inc.

E098

1.9 Item 2(Picture)

2. Roofing / Chimneys / Roof Structure and Attic



**2.9 Attic Electrical (Visible Electric Wiring in Attic, Switches, Outlets, and Light Fixtures) Repair or Replace**

The wiring installation of the power vent in the garage attic is non-standard. It is suspected that an amateur, rather than a licensed electrician or HVAC contractor performed the installation. Splices in electrical wiring should be enclosed in junction boxes and fitted with cover plates. This is a safety issue . Recommend a licensed electrician repair as needed to prevent accidental electric shocks.

2. Roofing / Chimneys / Roof Structure and Attic



2.9 Item 1(Picture)

### Electrical Wire Splices Without Box

*Exposed splice*

All splices in 110/120 or higher voltage must be inside an approved metal or plastic box. This protects the splice, supports the wire, and provides fire safety.

© Tom Feiza Mr. Fix-It Inc.

E098

2.9 Item 2(Picture)

3. Exterior



3.0 Siding and Trim  
Repair or Replace

No weep holes were found on the brick veneer. Weep holes are openings close to the bottom of the brick mortar joints that allow drainage. They are also recommended over door and window openings. Felt paper as well as metal flashing are commonly used for this purpose but cannot be seen without removal of the brick. Any water that might enter behind the brick against wood could cause decay. No visible signs of damage was found during the inspection. It is recommended that these weep holes be installed. A qualified masonry contractor should further investigate and correct if needed.

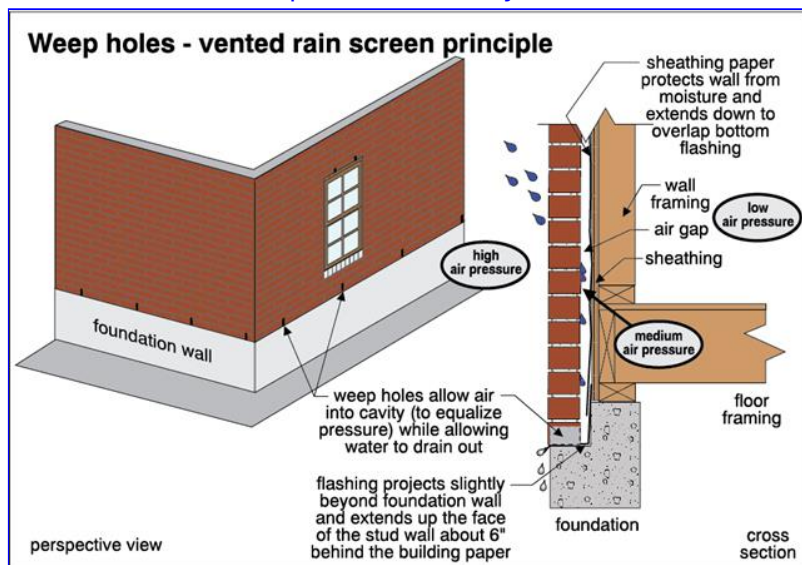

3.0 Item 1(Picture)

### 3. Exterior



#### 3.5 Decks, Structure, Railings, Stairs

##### Repair or Replace

(1) Some of the concrete footers have settled creating the post to pull away and tilt from the band board. Over time further settlement of the footers may cause the deck to possibly fail in the future. This is a safety issue. Recommend a qualified contractor repair as needed to ensure structural integrity of the deck and to prevent further settlement or leaning of the posts.



3.5 Item 1(Picture)



3.5 Item 2(Picture)

(2) 2x4s are installed for handrails for the deck staircase and are not considered "gripable" by industry standards. This is a safety issue and an injury could occur if not corrected. Recommend that a standard approved handrail be installed for safety by a general contractor.

### 3. Exterior



3.5 Item 3(Picture)

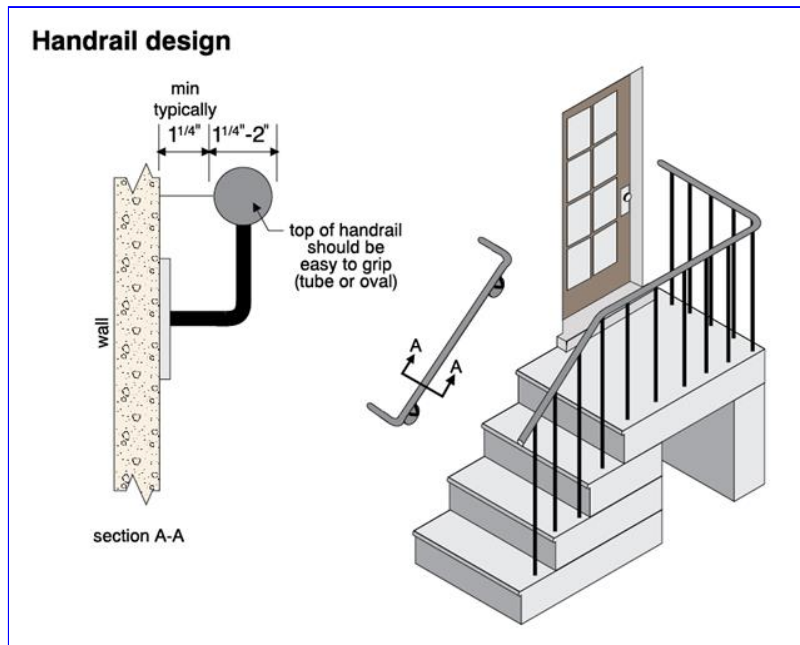

3.5 Item 4(Picture)

### 3.6 Driveways, Walkways (With respect to their effect on the condition of the building) Repair or Replace

(2) The front walkway has settled where it butts up to the driveway creating a possible tripping hazard. I do not see this as an indication of a structural issue. However, for safety and to prevent a tripping hazard and a fall or injury from occurring, recommend a qualified masonry contractor repair as needed.

### 3. Exterior



3.6 Item 3(Picture)

### 4. Garage/Carport

#### 4.5 Steps, Stairways, Balconies and Railings

##### Repair or Replace

The guard rail and stair case rails in the garage are loose, unstable and not secured properly. This is extremely dangerous and is a major safety concern. It may fail under a medium or heavy force or if someone was pushed against or was leaning on the railing. For your safety it should be strengthened and secured. Recommend a qualified contractor repair as needed before closing.



4.5 Item 1(Picture)

### 5. Kitchen / Components and Appliances



#### 5.5 Pantry/Closet Doors

##### Repair or Replace

The kitchen pantry door hits the door jamb at the top and does not close shut. This is a maintenance issue. Sometimes correcting the door opening can require door trim to be removed and painting touch up, and/or door hinges may need reseating to ensure correct closure of door. Recommend a general contractor repair as needed.

5. Kitchen / Components and Appliances



5.5 Item 1(Picture)



5.5 Item 2(Picture) top of frame

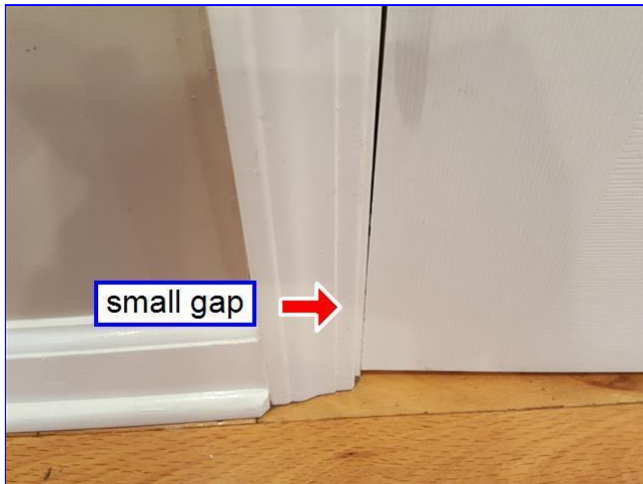

5.5 Item 3(Picture) bottom of frame

**Door Adjustment - Rubs**

Often a rubbing door can be corrected by using longer hinge screws or using wood strips and glue to fill the stripped screw hole.

© Tom Feiza Mr. Fix-It Inc.

D023

5.5 Item 4(Picture)





**5.8 Clothes Dryer Vent Piping Repair or Replace**

(2) The dryer vent piping is kinked. Damaged or bends in piping can cause an obstruction of lint that has a possibility to create a fire hazard. Recommend replacing flexible line prior to using dryer.

**5. Kitchen / Components and Appliances**



5.8 Item 2(Picture)

Choose these	Avoid these
 <p><b>RIGID METAL</b> These are least likely to sag.</p>	 <p><b>FLEXIBLE PLASTIC</b> These are likely to sag and trap lint.</p>
 <p><b>FLEXIBLE METAL</b> Also good, these hold their shape if bent.</p>	 <p><b>FLEXIBLE FOIL</b> These may look like flexible metal but don't hold their shape if bent.</p>

5.8 Item 3(Picture)

**6. Rooms**



**6.6 Closets**

**Repair or Replace**

The mirrored closet door in the 3rd bedroom is cracked. This is a potential safety issue as a person or child could be injured or be cut. Recommend replacement as needed by a general contractor.



6.6 Item 1(Picture)

**6.7 Outlets, GFCI, Wall Switches and Fixtures (Lights and Ceiling Fans)**

**Repair or Replace**

6. Rooms



The outlet(s) where indicated in the photo(s) are loose at the wall or in the outlet box. Electrical issues are considered a hazard until repaired. This is a safety issue that needs to be corrected due to an electric shock or fire from loose connections could occur if not repaired. Recommend a qualified licensed electrical contractor correct as needed.



6.7 Item 1(Picture) dining room



6.7 Item 2(Picture) kitchen hallway

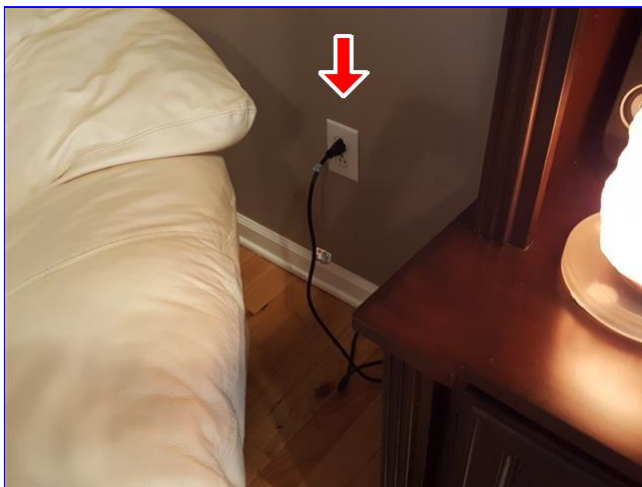

6.7 Item 3(Picture) living room



6.7 Item 4(Picture) washer dryer room

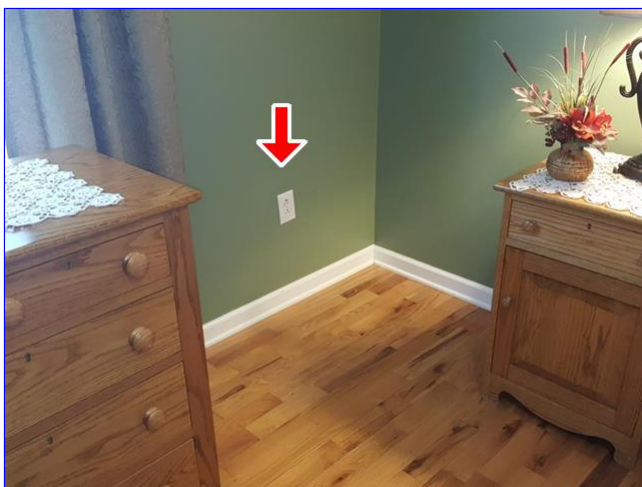

6.7 Item 5(Picture) master bedroom

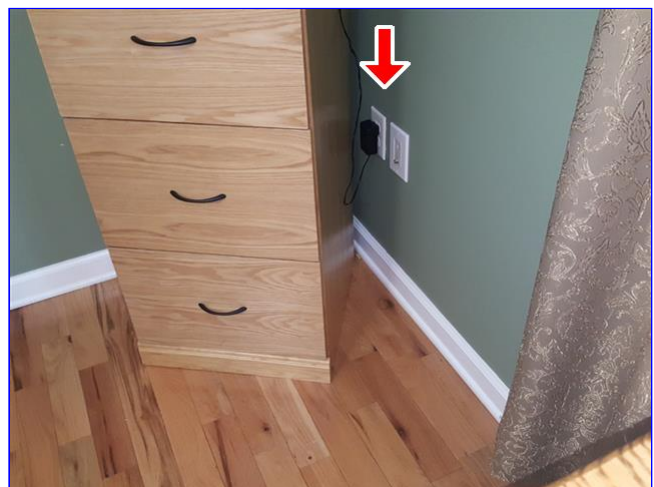

6.7 Item 6(Picture) master bedroom



6. Rooms



6.7 Item 7(Picture) hallway

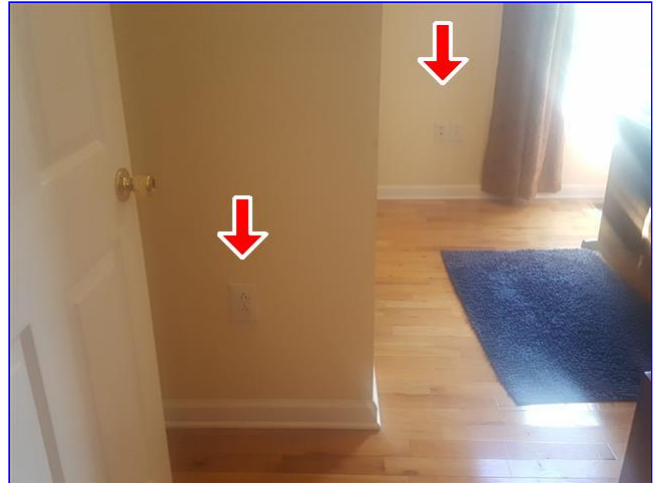

6.7 Item 8(Picture) 3rd bedroom

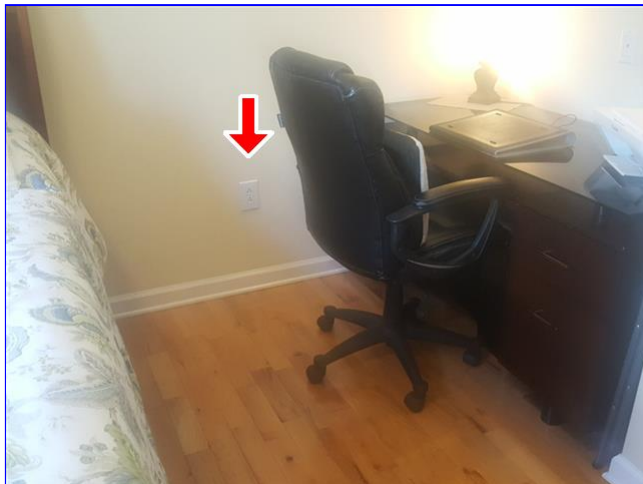

6.7 Item 9(Picture) 3rd bedroom



6.7 Item 10(Picture) 2nd bedroom

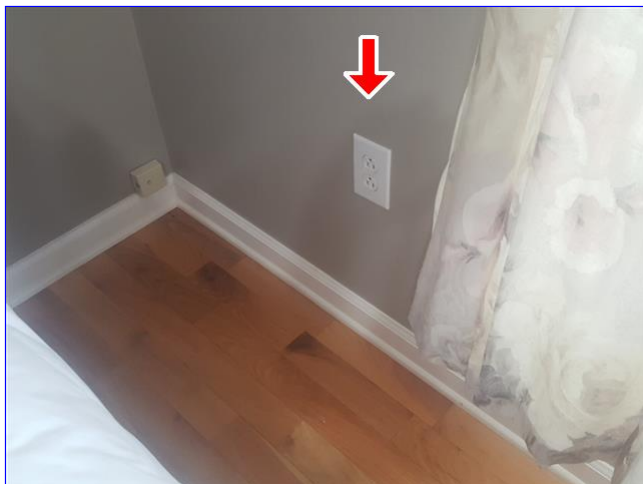

6.7 Item 11(Picture) 2nd bedroom

**6.8 Smoke and Carbon Monoxide Detectors  
Repair or Replace**

(2) The smoke detectors are hanging loose at the ceiling in the 2nd Bedroom. These may not be working due to contacts are not connected correctly. It is also placing strain at the connections which

## 6. Rooms



could result in detectors not functioning. Recommend these be secured to the ceiling prior to moving in, then tested to ensure they are working.



6.8 Item 2(Picture)

## 7. Bathroom and Components



### 7.4 Plumbing Water Supply, Shutoffs, Faucets, and Fixtures Repair or Replace

(1) The control knob on the cold water faucet leaks at the jacuzzi when moved abruptly in the master bathroom. New seals maybe needed. Recommend a licensed plumber repair or replace as needed.



7.4 Item 1(Picture)

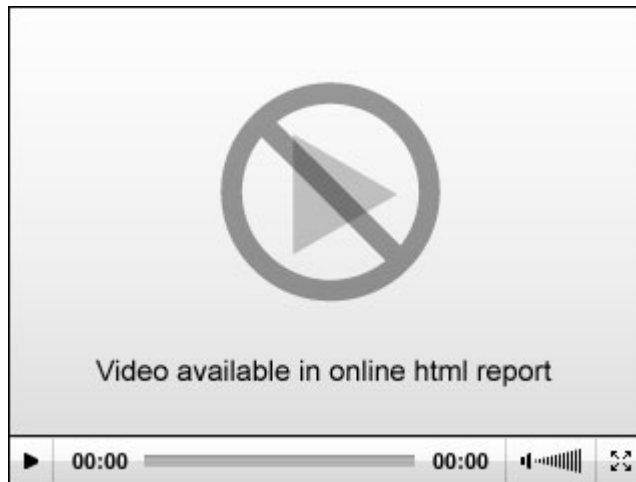

7.4 Item 2(Video)

(2) The drain control stopper is not connected at the sink and does not function in the 2nd bathroom (closest to 2nd bedroom). Recommend correcting to allow easy use of the drain lever and to ensure it functions properly. Repair or correct as needed.

**7. Bathroom and Components**



7.4 Item 3(Picture) left side closest to 2nd bedroom

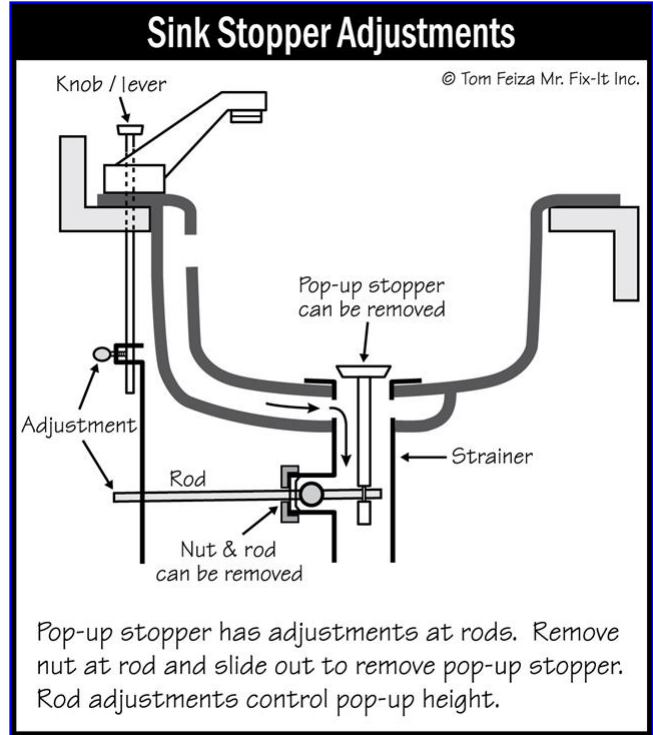

P097

7.4 Item 4(Picture)

**7.6 Outlets, GFCI (Ground Fault Circuit Interupters), Wall Switches and Fixtures**

**Repair or Replace**

(3) The outlet(s) in the 2nd bathroom where indicated in the photo(s) is loose in the wall or at the outlet box. Electrical issues are considered a hazard until repaired. This is a safety issue that needs to be corrected due to an electric shock or fire from loose connections could occur if not repaired. Recommend a qualified licensed electrical contractor correct as needed.



7.6 Item 1(Picture)

**7.8 Jacuzzi Tub**

**Repair or Replace**

(3) The on/off switch for the operation of the pump for the jacuzzi does not function at the tub. The unit was operated at the wall switch in the bathroom. Recommend an electrician repair or replace switch as needed for ease of use.

## 7. Bathroom and Components

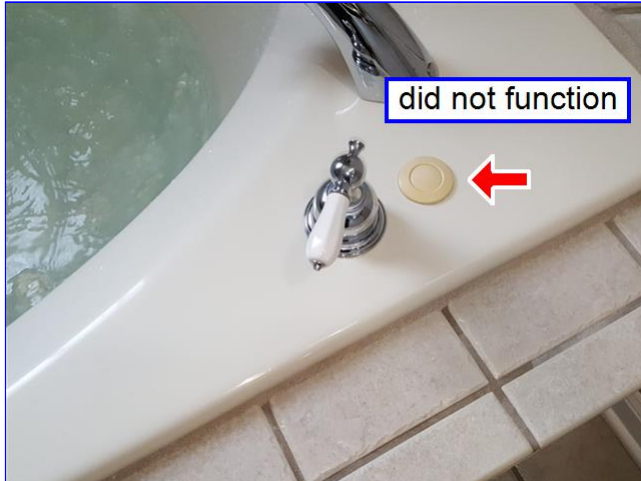

7.8 Item 3(Picture)



7.8 Item 4(Picture)

## 10. Heating / Central Air Conditioning



### 10.0 Heating / Cooling Equipment

#### Repair or Replace

(6) The Heat Pump was continuously running during the inspection period. This indicates that the unit is not running efficiently. This can cause a shorter life span on the compressor and damage to the unit. The unit may need servicing. Recommend a qualified HVAC contractor further evaluate the unit and repair as needed.

### 10.1 Filter Location/Condition

#### Repair or Replace

(2) The filter in the hallway is dirty at the return register which reduces the efficiency of the HVAC system and shortens it's life. Your filter is designed to keep airborne dirt from clogging your blower. If the filter itself gets clogged, then the system cannot move enough air, and it won't perform efficiently. Filters should be checked once a month or according to manufacturers recommendations and replaced as needed. Recommend the filters be replaced now.



10.1 Item 3(Picture)

### 10.4 Ducts and Registers

#### Repair or Replace

## 10. Heating / Central Air Conditioning



(2) The return air duct is not sealed at the plenum at the Air Handler in the crawlspace. This is allowing unfiltered air in the crawlspace to enter the home via the blower which is allowing contaminants to enter the unit. This is a health issue. This can also cause damage to the unit and blower, increase heating/cooling costs. Recommend a qualified HVAC repair ductwork where necessary.

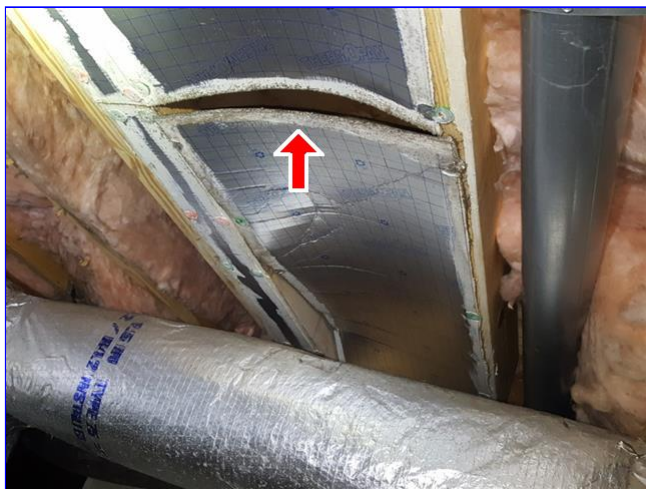

10.4 Item 1(Picture)

### 10.6 Normal Operating Controls (Thermostat)

#### Repair or Replace

(2) The thermostat is not functioning correctly. The reading for the inside air temperature is not working correctly. It appears to be at least 3 degrees out of balance. This can cause the unit to run longer and harder which was experienced during the inspection, (see note 10.0(6) ) it also increases the cost in running the unit. Recommend a qualified HVAC contractor further investigate and repair or replace as needed.

### 10.8 General Notes

#### Inspected

(1) During the inspection it was noted that the home was not being cooled as intended. After the heat pump was tested for emergency heating, the temperature within the home was 76 degrees. Now the system was set for cooling in the home and the thermostat was set to 69 degrees and the system was continuously running after 4 hours and the thermostat reading was 70 degrees. This indicates that the unit is not running efficiently. This could be caused by a number of conditions, some could be costly. This condition can increase cooling and heating costs and add wear and tear on the HVAC units within the home. Recommend a qualified licensed HVAC contractor further inspect and evaluate the heat pump and air handler for proper operation before closing.

(3) Due to issues found with the HVAC system and there age, strongly recommend a qualified HVAC contractor further evaluate both units, repair issues found and others that are not visible during the inspection, and have both units serviced to ensure they are operating efficiently and safely before moving into home, especially due to the Heat Pump was not tested for operation in the heating mode.

---

Home inspectors are not required to report on the following: Life expectancy of any component or system; The causes of the need for a repair; The methods, materials, and costs of corrections; The suitability of the property for any specialized use; Compliance or non-compliance with codes, ordinances, statutes, regulatory requirements or restrictions; The market value of the property or its marketability; The advisability or inadvisability of purchase of the property; Any component or system that was not observed; The presence or absence of pests such as wood damaging organisms, rodents, or insects; or Cosmetic items, underground items, or items not permanently installed. Home inspectors are not required to: Offer warranties or

guarantees of any kind; Calculate the strength, adequacy, or efficiency of any system or component; Enter any area or perform any procedure that may damage the property or its components or be dangerous to the home inspector or other persons; Operate any system or component that is shut down or otherwise inoperable; Operate any system or component that does not respond to normal operating controls; Disturb insulation, move personal items, panels, furniture, equipment, plant life, soil, snow, ice, or debris that obstructs access or visibility; Determine the presence or absence of any suspected adverse environmental condition or hazardous substance, including but not limited to mold, toxins, carcinogens, noise, contaminants in the building or in soil, water, and air; Determine the effectiveness of any system installed to control or remove suspected hazardous substances; Predict future condition, including but not limited to failure of components; Since this report is provided for the specific benefit of the customer(s), secondary readers of this information should hire a licensed inspector to perform an inspection to meet their specific needs and to obtain current information concerning this property.

*Prepared Using HomeGauge <http://www.HomeGauge.com> : Licensed To Giancarlo Barone*

# Conditional General Summary



**TALON**  
Home Inspections

**Talon Home Inspections, LLC**

**4101 Tates Creek Centre Drive  
Suite 150 - PMB 312  
Lexington, KY, 40517  
(859) 447 0050**

**Customer**

Mr. Mark Stevens

**Address**

3002 Wheeler Street  
Georgetown KY 40324

The following items or discoveries indicate that these systems or components **appeared to be functioning as intended, but is in need of minor repair or correcting to prevent possible issues that can effect the building.** This summary shall not contain recommendations for routine upkeep of a system or component to keep it in proper functioning condition or recommendations to upgrade or enhance the function or efficiency of the home. This Summary is not the entire report. The complete report may include additional information of concern to the customer. It is recommended that the customer read the complete report.

## 1. Structural Components



### 1.2 Crawlspace Floor (Vapor Retarders)

**Conditional**

(1) All wood should be removed from the crawlspace floor. Wood debris risks rotting and can attract wood eating insects into the crawlspace which can lead to more costly repairs later. Recommend all types of debris resting on the crawlspace floor be removed to prevent damage to the wood structure of the home.

## 1. Structural Components



1.2 Item 1(Picture)

(2) There are some gaps in the coverage of the vapour barrier in the crawl space floor where indicated in the photo(s). The vapor barrier in the crawl space floor should be adjusted to cover all areas of exposed soil. These gaps are allowing moisture vapor entry into the crawl space which promotes condensation, humidity and mold/mildew growth on the floor joists. The plastic vapour barrier should be a minimum of 9mil thick in Kentucky (recommend using 15 or 20 mil) straightened and/or added to as needed to cover the entire crawlspace floor to prevent excessive moisture entering. Recommend correcting as needed using a qualified contractor.



## 1. Structural Components



1.2 Item 2(Picture)



1.2 Item 3(Picture)



1.2 Item 4(Picture)

## 2. Roofing / Chimneys / Roof Structure and Attic



### 2.3 Roof Drainage Systems (drip edge, gutters, downspouts, and splashblocks)

#### Conditional

(3) Recommend the downspout(s) at the home where indicated in the photo(s) be extended at least 6 feet and flow onto splashblocks. This will ensure water is kept away from the foundation perimeter, soil erosion does not occur and water cannot leak into the crawlspace area which may cause settlement of the foundation.

Note: You may wish to consider burying the extension to prevent a tripping hazard. See photos for example.

2. Roofing / Chimneys / Roof Structure and Attic



2.3 Item 5(Picture) front left corner of home



2.3 Item 6(Picture) rear right corner of home



2.3 Item 7(Picture) rear left side of home



2.3 Item 8(Picture)



2.3 Item 9(Picture)

### 3. Exterior



#### 3.6 Driveways, Walkways (With respect to their effect on the condition of the building)

##### Repair or Replace

(1) Common settlement crack(s) were noted at the concrete drive. This is not a tripping hazard as yet at this time. I also do not see these small cracks as an indication of a structural issue. Further deterioration and/or settlement can occur to the driveway via water intrusion if not repaired.

Recommend repairs via a masonry caulk as needed then monitor annually. Here is a link for [Sealing Concrete Cracks](#)

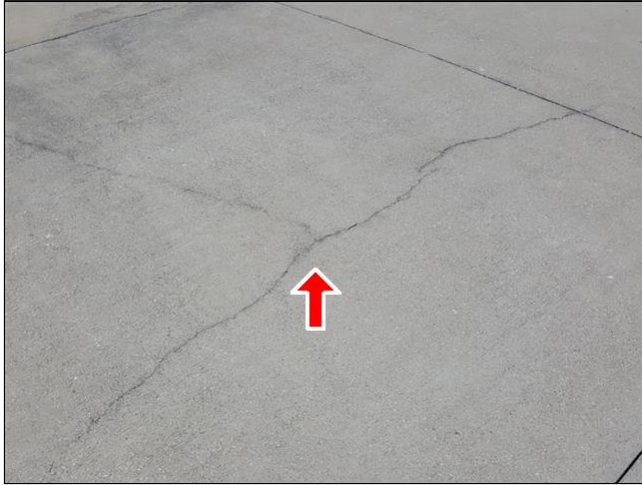

3.6 Item 1(Picture)



3.6 Item 2(Picture)

#### 3.9 Vegetation, (With respect to their effect on the condition of the building)

##### Conditional

The shrub at the rear left corner of the home could disrupt gutter, cause mechanical damage to the exterior of home or influence the foundation over time. It would be wise to consider trimming or removal of the shrub. Also recommend that shrubs or bushes be kept neatly trimmed and away from the exterior of home, a minimum of six inches to allow proper venting.



3.9 Item 1(Picture)

### 4. Garage/Carport

#### 4.2 Garage Floor

##### Conditional

**4. Garage/Carport**

The garage flooring has typical cracks in areas highlighted in photos. These cracks do not appear significant and seem typical. Cracks that are usually 1/8 inch or wider are need for concern. The cracks are usually the result of shrinkage and/or settling of the slab. Recommend these cracks be sealed then apply an epoxy coating on the floor to ensure water intrusion does not occur. It is recommended that you monitor annually after repairs. If these cracks should reoccur a masonry contractor who is familiar with foundation repair should be consulted. [Caulk for Concrete Cracks](#)



4.2 Item 1(Picture)

**5. Kitchen / Components and Appliances**



**5.1 Plumbing Drain and Vent Systems**

**Conditional**

The disposal drain line is incorrectly pitched to the sink drain line from the disposal unit under the sink in the kitchen. This can cause the drain line to clog. Recommend a qualified plumber correct as needed.

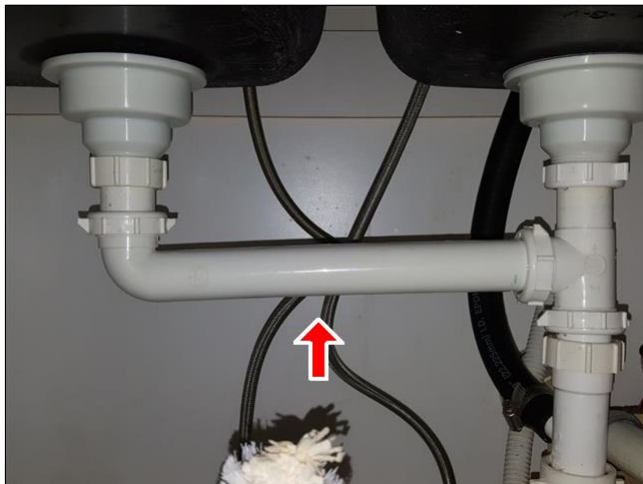

5.1 Item 1(Picture)

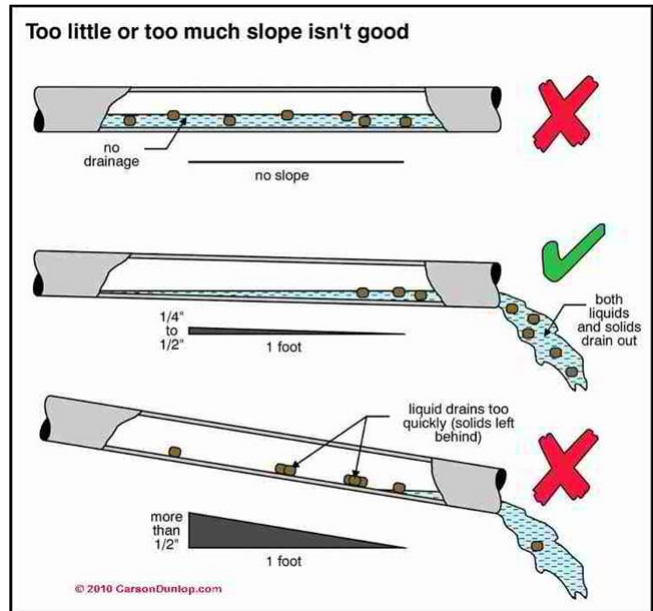

5.1 Item 2(Picture)

10. Heating / Central Air Conditioning



10.0 Heating / Cooling Equipment

Repair or Replace

(2) Vegetation in the vicinity of the outdoor unit of the Heat Pump should be cut back to prevent obstruction of the airflow. This can cause damage to the unit via running hot, shorten its life expectancy, and cause it to run inefficient. Recommend removing all the vegetation surrounding the unit so that the fins are not obstructed.

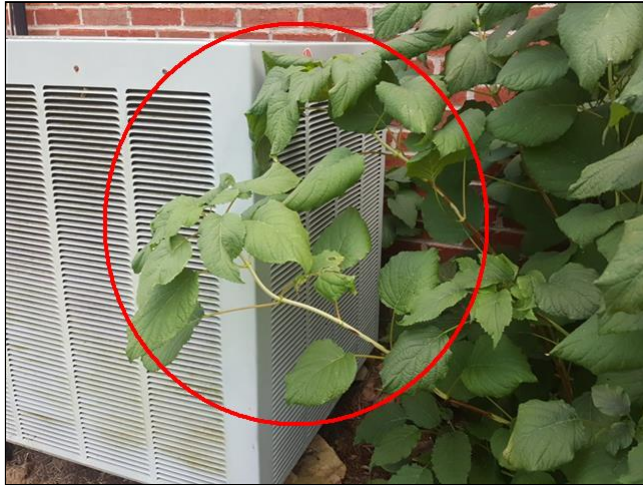

10.0 Item 1(Picture)

AC Condenser - Clearance to Obstructions

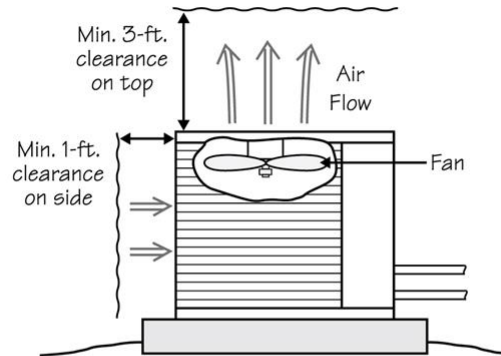

An air conditioning condenser dissipates heat to the exterior air. There should be a 3-foot clearance at the air discharge and a 1-foot clearance where air enters the coil.

© Tom Feiza Mr. Fix-It Inc.

A013

10.0 Item 2(Picture)

(3) The platform foot for the Heat Pump unit is not supporting the corner of the unit correctly. Over time this may settle further causing the unit to fall off its support which could result in a leak at the large suction line. It could also result in the unit to be unstable. Recommend a qualified HVAC contractor correct as needed to avoid this in the future.



10.0 Item 3(Picture)

(5) The refrigerant lines that enter the Air Handler are missing grommets where they enter the evaporative coil. Conditioned air is discharging into the crawlspace which can result in condensation/moisture occurring in the attic. This is inefficient, all the warm/cool air should be directed to the ducts. Recommend a qualified HVAC contractor repair as needed.

**10. Heating / Central Air Conditioning**

10.0 Item 4(Picture)

**10.3 Distribution Systems (Pipes and Pumps)****Conditional**

(1) Recommend the discharge for the condensate drain line be improved via installing a splash block and extending the drain line at the left side of the home. This will prevent water pooling near the foundation which could cause settlement of the foundation wall, soil erosion and water leakage into the crawlspace. Also to prevent possible settling of the platform for the Heat Pump. A qualified HVAC contractor is recommended for these repairs.

10. Heating / Central Air Conditioning

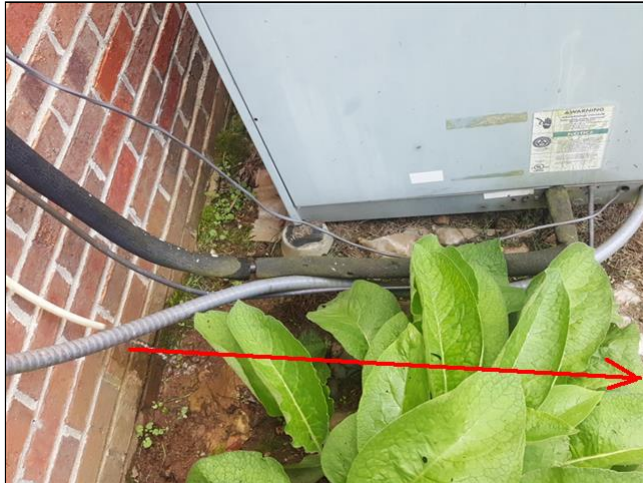

10.3 Item 1(Picture)

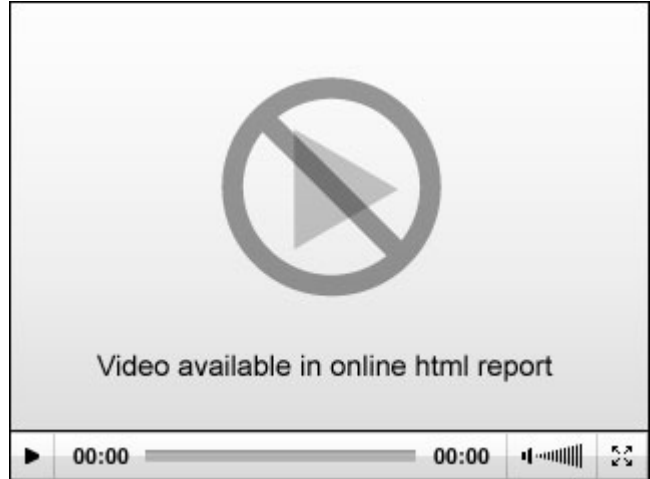

10.3 Item 2(Video)

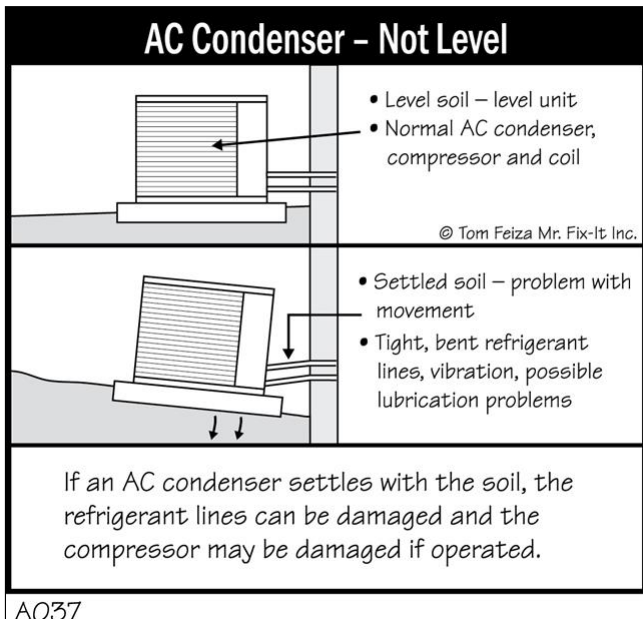

A037

10.3 Item 3(Picture)

(2) The foam sleeve on the large suction line for the outside Heat Pump is deteriorated and missing at areas. This can cause condensation and increased system operating costs via the unit not operating efficiently. This is a small repair. This insulation is to maintain or stabilize the temperature of the gas used in the system. The outside temperature can influence this gas and cause efficiency fluctuations of the unit. Recommend installing a new sleeve, this will help maintain efficiency of the compressor.

10. Heating / Central Air Conditioning



10.3 Item 4(Picture)



10.3 Item 5(Picture)

---

Prepared Using HomeGauge <http://www.HomeGauge.com> : Licensed To Giancarlo Barone





**TALON**  
Home Inspections

**INVOICE**

**Talon Home Inspections, LLC**  
**4101 Tates Creek Centre Drive**  
**Suite 150 - PMB 312**  
**Lexington, KY, 40517**  
**(859) 447 0050**  
**Inspected By: Giancarlo Barone**

**Inspection Date: 8/22/2018**  
**Report ID: 140822WILLOUGHBY**

<b>Customer Info:</b>	<b>Inspection Property:</b>
Mr. Mark Stevens 3002 Wheeler Street Georgetown KY 40324  <b>Customer's Real Estate Professional:</b>	3002 Wheeler Street Georgetown KY 40324

**Inspection Fee:**

<b>Service</b>	<b>Price</b>	<b>Amount</b>	<b>Sub-Total</b>
Sq Ft 0 - 2000	365.00	1	365.00
Crawlspace / Basement	40.00	1	40.00
			<b>Tax \$0.00</b>
			<b>Total Price \$405.00</b>

**Payment Method:** Check  
**Payment Status:** Paid At Time Of Inspection  
**Note:**



**Talon Home Inspections, LLC**

**Giancarlo Barone**

**4101 Tates Creek Centre Drive  
Suite 150 - PMB 312  
Lexington, KY, 40517  
(859) 447 0050**

