

Ashley Norton

ARCHITECTURAL HARDWARE



APRIL 2024 PRICE BOOK
SOLID BRONZE COLLECTION

INTRODUCTION

The Ashley Norton Advantage

Established in 1987, Ashley Norton has grown to become one of the leading designers and manufacturers of architectural hardware. We have developed a wide range of products including a collection of designs, finishes and styles that suit even the most discerning customer.

We pride ourselves on the technical aspects of our product:

- Products sand cast from the finest art grade bronze, assuring a naturally flowing texture
- European engineering and design, with spring assisted levers to eliminate lever sag
- European made, short-throw (28 degree) latch which minimizes effort to open the door
- ANSI Grade 1 certified, US made entry mortise locks, exceeding 5 million cycles
- Stainless steel components used wherever possible to increase durability and resist corrosion

The durability of our products, our elegant and unique designs, and our best-in-class value-proposition are the amongst the many reasons why our products are selected again and again by design professionals in the high-end residential and hospitality industries. As a testimonial to the versatility and quality of our products, consider the following list of projects enjoying Ashley Norton products: Wynn Las Vegas, Wynn Macau, Treasure Island, The Bellagio, Beau-Rivage and The Ritz-Carlton (Naples).

Environmentally Sound

At Ashley Norton we believe that being environmentally responsible is part of our job. Over the years, we have implemented various steps to reuse, reduce and recycle materials at every stage in our factory as well as in our offices.

- The character of our products is bolstered by a 90% recycled bronze content
- All of the bronze used in our machining and casting processes is reclaimed for reuse
- The non-destructive casting process we employ allows us to reclaim our molds for use again and again
- Our packaging is made from recycled materials

TABLE OF CONTENTS

INTRODUCTION 3

TERMS & CONDITIONS

OF SALE 5

RETURNS POLICY 6

WARRANTY 7

CUSTOM ORDERS 8

ORDERING GUIDELINES 9

OUR PATINAS 10

LEVERS & KNOBS 11

URBAN SUITE 19

Mortise Entrysets / 19

Tubular Entrysets & Deadbolts / 21

Passage & Privacy Sets / 23

RECTANGULAR SUITE 25

Mortise Entrysets / 25

Tubular Entrysets & Deadbolts / 27

Passage & Privacy Sets / 29

ARCHED SUITE 31

Mortise Entrysets / 31

Tubular Entrysets & Deadbolts / 33

Passage & Privacy Sets / 35

CURVED SUITE 37

Mortise Entrysets / 37

Tubular Entrysets & Deadbolts / 39

Passage & Privacy Sets / 41

ANGULAR SUITE 43

Mortise Entrysets / 43

Tubular Entrysets & Deadbolts / 45

Passage & Privacy Sets / 47

TRADITIONAL SUITE 49

Passage, Privacy Sets & Deadbolts / 49

MULTIPOINT HANDLESETS 51

Handlesets for Swinging Doors / 53

Handlesets for Sliding Doors / 59

**SPECIALTY DOOR &
WINDOW HARDWARE 61**

Edge & Flush Pulls / 61

Sliding & Pocket Door Hardware / 62

Gate Hardware / 63

Surface Bolts & Cane Bolt / 65

Tilt & Turn Window Handles / 66

Window Hardware / 67

Solid Brass Hinges / 68

Door Stops / 69

DOOR PULLS & PUSH PLATES 70

Pull Handles / 71

Push Plates / 72

HOME ACCESSORIES 73

Bathroom Accessories / 73

Hooks / 76

Door Knockers / 77

House Numbers / 78

Bell Buttons / 79

Clavos & Strap Hinges / 79

Switch & Outlet Covers / 80

**Cabinet hardware and appliance pull pricing is
published in our dedicated Cabinet Hardware catalog.**

TERMS & CONDITIONS OF SALE

Terms

Net 30 (subject to credit check and account approval). A monthly finance charge, computed at a periodic rate of 18% will be added to all past due accounts. The amount of credit we extend to a customer is subject to change or limitation at any time, either before or after delivery of any part thereof, of an order. Payment in advance may be required prior to delivery. If a customer's account is in arrears, we shall have the right, in addition to all other legal remedies and without prejudice to any other of our rights, to defer further shipments until payment is received. We reserve the right to ship on a C.O.D. basis when considered necessary. All goods supplied remain the property of Ashley Norton Inc. until paid in full; provided, however, that risk of loss for such items shall be borne entirely by the Buyer upon delivery of such goods by Ashley Norton Inc. (F.O.B. Pompton Plains, NJ) as detailed below. All accounts that are deemed consistently problematic in the sole discretion of Ashley Norton Inc. including but not limited to untimely payments, excessive ordering errors or excessive returns are subject to closure at Ashley Norton Inc.'s discretion.

Prices

All prices are subject to change without prior notice. All orders accepted will be priced according to the prevailing price at time of shipment. Orders delayed due to "on hold" account status will be charged at the price effective on date of shipment. All Prices are exclusive of all local, state and federal taxes. Wherever applicable, such taxes will be added to the invoice as a separate charge to be paid by the Buyer.

Claims

Any claims for shortages must be made in writing within 14 days from date of invoice. Any claims for defective merchandise or billing errors must be made in writing within 30 days from date of invoice. No claim will be allowed for work or modifications done by others, for incidental or consequential damages, or for other expenditures. The liability of Ashley Norton Inc., is limited to its obligation to repair or replace defective goods as set forth below.

TERMS & CONDITIONS OF SALE

Specifications

Sizes and designs may be changed without notification. Ashley Norton Inc reserves the right to discontinue products without prior notice.

Order Cancellations & Changes

Ashley Norton Inc will attempt to comply with faxed order changes or cancellations, however, we cannot guarantee that they can be accomplished before shipment. Handling charges will apply if goods had been manufactured prior to processing a change or cancellation request. Orders for nonstock or special items cannot be cancelled or changed without consent from Ashley Norton Inc. Where items have not been manufactured, we will endeavor to action a cancellation or change request. However, where items have been manufactured any cancellation or change is subject to approval by Ashley Norton Inc. and will result in a handling charge of up to the full order value.

Disputes

All disputes relating in any way to these Terms and Conditions of Sale shall be resolved in an appropriate court located in the State of New Jersey, and such disputes shall be governed entirely by New Jersey law.

RETURNS POLICY

Returned goods will not be accepted without prior written authorization. Minimum net amount for return of hardware is \$25.00 except in case of Ashley Norton error.

All requests for RGAs must be made in writing within 60 days of original invoice date. RGA numbers are valid for 30 days from date of issuance and will not be re-issued. A minimum 30% restock charge plus freight will apply to items returned in original condition and packaging and having a factory issued RGA number. If a factory defect is claimed, an RGA will be issued for inspection purposes only. Any credit due will be determined upon inspection; approved returns will be credited. All returns must be shipped freight pre-paid. COD returns will be refused.

ITEMS SOLD IN SPECIAL FINISHES, SPLIT FINISHES AND CUSTOM ITEMS ARE NON-RETURNABLE.

Special order or discontinued items will not be accepted for return except in case of manufacturing error.

WARRANTY

Mechanical Warranty

Ashley Norton Inc. extends a 10 year mechanism warranty to the original residential purchaser, providing the product has been installed in strict accordance with our installation instructions. The only obligation of Ashley Norton Inc. will be to repair or replace the defective product or parts upon presentation, together with proof of purchase dated within the warranty period. We assume no liability for any labor charges regarding the removal or reinstallation of the products; nor will we cover any freight, postage, or handling expense. This warranty does not cover damage caused by accident, misuse, abuse, tampering, extreme climatic conditions, improper installation or products used in commercial applications.

Finish Warranty

Our bronze patinas are 'living finishes' and may lighten, highlight, oxidize or rub off in places due to frequency of use; therefore, such events do not constitute a defect.

Our Matt Black finish is susceptible to chipping. Such chipping is a feature of the finish and in no way constitutes a defect. The finish may be easily restored by the application of a spot of black paint to the chipped area.

Thus Ashley Norton Inc., cannot guarantee our Bronze and Matt Black finishes and therefore, Ashley Norton Inc. will not have any obligation to repair or replace such finishes under this warranty.

Exclusion of Incidental and Consequential Damages

In no event shall Ashley Norton be liable for any incidental or consequential damages arising from the sale or use of our products. We assume no liability for any labor charges regarding the removal or reinstallation of the products; nor will we cover any freight, postage, or handling expense related to the product. The only obligation upon Ashley Norton Inc. will be to repair or replace the defective product or parts upon presentation, together with proof of purchase dated within the warranty period.

CUSTOM ORDERS

Ashley Norton welcomes your requests for custom products. From modifications to existing designs to completely new products, we welcome the opportunity to discuss your requirements. Minimum quantities and special charges may apply.

Examples of our capabilities include:

- Custom lever or plate designs
- Custom sizes for existing designs, e.g. cabinet knobs or pulls in alternative sizes, or plates in alternative sizes
- Products to suit specific multipoint locks
- Handlesets with narrow (or extended) backset mortise locks. Note that narrow backset mortise locks are not available in a grip x lever/knob configuration

If a custom order is cancelled after work has begun, charges will be billed for time and costs incurred to date.

Please call or email us (custom@ashleynorton.com) with your requirements. When emailing, be sure to include as much detail as possible, particularly on quantities required.

MORTISE LOCK OPTIONS

ANSI F12 Entry Accurate 9148B Lock

- Latch bolt by key outside and lever either side unless outside lever is locked by toggle action stop
- Deadbolt by key outside and turn piece inside
- Turning inside lever retracts latch and deadbolt simultaneously, **outside lever remains locked until manually unlocked by toggle**



ANSI F13 Dormitory Accurate 9124B Lock

- Latch bolt by lever either side
- Deadbolt by key outside and turn piece inside
- A turn of inside lever retracts latch and deadbolt simultaneously, **automatically unlocking outside lever.**



ORDERING GUIDELINES

Almost any combination of lever, knob, escutcheon and finish may be combined to create a unique piece for your client's project. Our staff will be delighted to assist if you have any questions regarding compatibility of levers/escutcheons or other technical questions. Some frequently requested information is presented below.

Product Code Construction

We have provided guides throughout the price book which explain how to construct part numbers for specific combinations of levers, plates and finishes. Should you require any assistance, please do not hesitate to contact us.

Handing Guide

Most of our interior sets (tubular passage/privacy) do not require handing. Handing is required for single dummies, entry hardware and all mortise interiors.

Backset, Strike, Door Thickness

Our hardware is supplied with accessories to suit a typical door. However, a number of options are available to suit particular circumstances.

	Standard	Option
<i>Please call to verify suitability for any doors thicker than 2 1/2"</i>		
Tubular Passage / Privacy Sets		
Door thickness	1 3/8" - 1 3/4"	Up to: 3" (passage); 2 1/2" (privacy)
Backset	2 3/8"	2 3/4"
Strike	Full Lipped Strike	T Strike
Deadbolts		
Door thickness	1 3/4"	Up to: 3" (standard); 2 1/4" (double-keyed)
Backset	2 3/8"	2 3/4"
Tubular Entrysets		
Door thickness	1 3/4"	Up to 3" - see footnote (a) below
Backset	2 3/8"	2 3/4"
Strike	Full Lipped Strike	T Strike
Mortise Entrysets		
Door thickness	1 3/4"	Up to 3" (upcharge for doors 2 1/2" or thicker)
Backset	2 1/2"	2 3/4" (call for narrow or extended backset)
Strike	Mortise strike	Mortise strike
Multipoint Trim		
Door thickness	1 3/4"	Up to 2 1/4" (inquire for thicker doors)
Strike	Not included	Not included

(a) Max. thickness for double keyed entryset is 2 1/4". Max. thickness for tubular gripset is 2 1/2"

Handing Guide For Swinging Door Hardware

Door handing is always determined from outside of the door. The side of the door that the hinges are on determines the handing of the door. For mortise sets, we need to know the swing direction of the door. Most doors swing in, but if the door swings outwards, designate this as reverse swing.

- L** = Left Hand
- R** = Right Hand
- LHR** = Left Hand Reverse (needed for mortise sets only)
- RHR** = Right Hand Reverse (needed for mortise sets only)

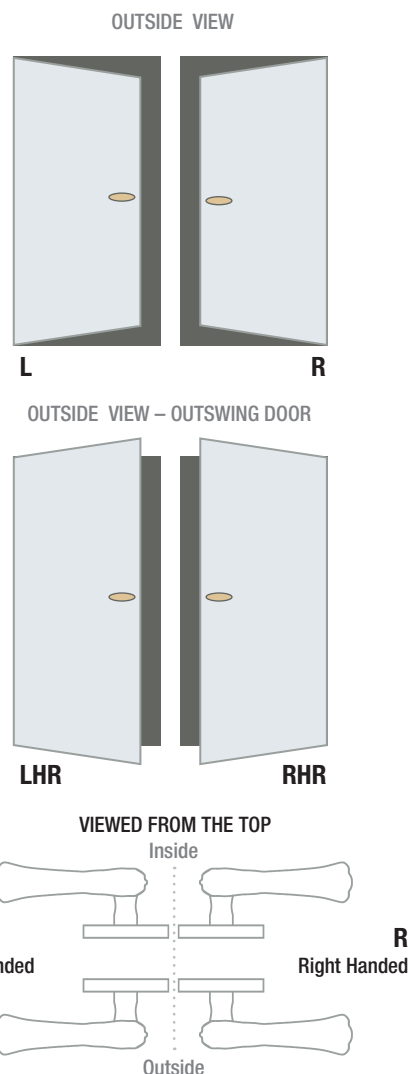

Ashley Norton utilizes the finest art grade bronze alloys in the production of our hardware. Our Dark Bronze (BZ), Natural Bronze (NB) and Matt Black (TC) products are produced from silicon bronze, a coppery-gold colored alloy of copper, silicon and zinc.

Our **Dark Bronze (BZ)** patina is our most popular, and allows for the greatest uniformity in shade at time of delivery. We aim to stock the most popular items in this patina.

Our new **Natural Bronze (NB)** patina infuses a modern natural bronze tone with the ageless texture typical of sand cast bronze hardware.

Our **Matt Black (TC)** products are created through the application of a black powder coat. The combination of distressed bronze with a modern black finish offers a striking look which works well in a transitional or modern space.

Our **White Bronze (WL)** products are produced from an alloy known simply as white bronze. The infusion of manganese and nickel to the copper creates a pleasing silver colored metal.

Our **White Medium (WM)** patina products are hand finished in small batches. Each batch will be similar in hue, however different batches may have slight variation in tone. Such differences are caused not only by the small variation in time for which the item is oxidized, but also environmental factors such as humidity and temperature.

Ashley Norton applies a light coating of wax to protect our products from oxidization and wear. As the wax coating wears off, the patinas will be exposed to the environment. The effects of age, climate and touch will work in conjunction to create unique, contrasted color variations. The most frequently touched areas will highlight as the patina wears off and natural shades of bronze are exposed. Areas which are not handled may oxidize further, and the combination of colors and hues will accentuate the timeless elegance of bronze.

LEVER OPTIONS



Churchill (500) lever

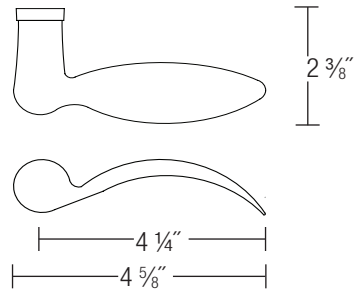

Chiltern (160) lever

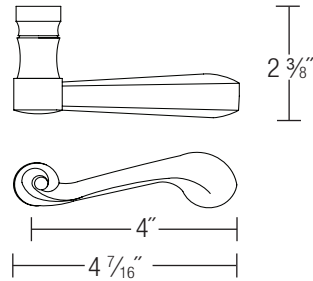

Colonial (490) lever

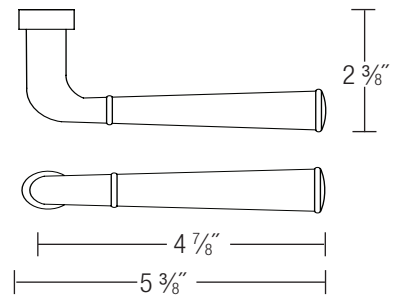

Hampton (400) lever

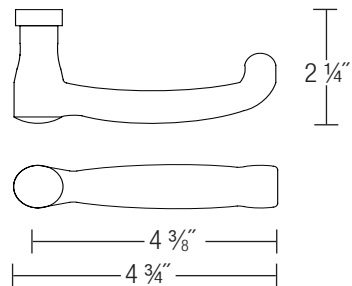

Shropshire (800) lever

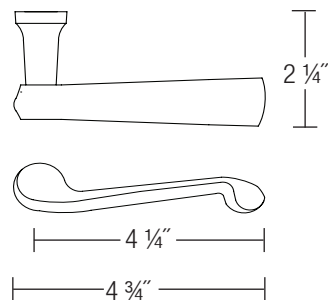

LEVER OPTIONS



Chester (200) lever

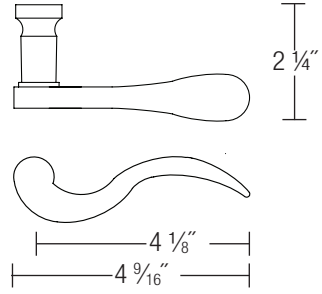

Elm (580) lever

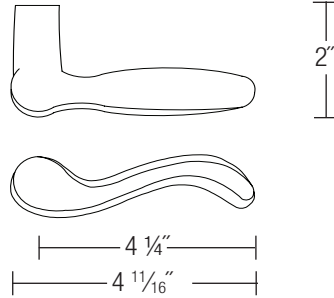

Alessa (830) lever

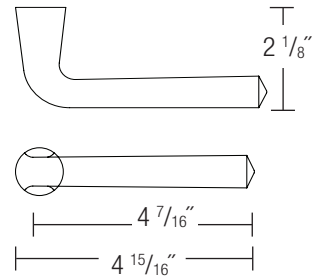

Greenwich (350) lever

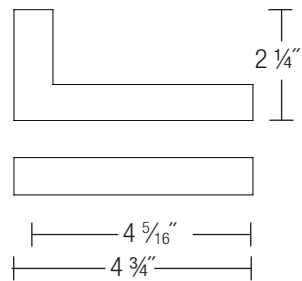

Apollo (450) lever

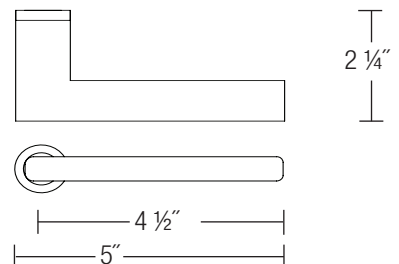

LEVER OPTIONS



Atlas (375) lever

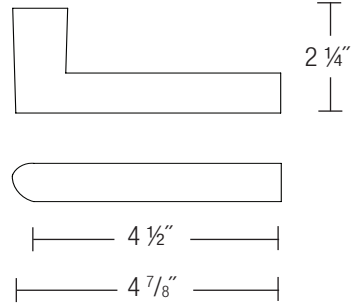

Centaur (349) lever

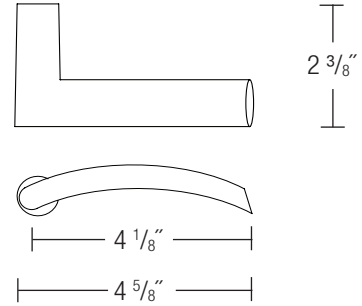

Meridian (310) lever

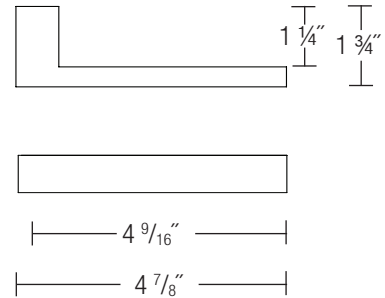

Adonis (985) lever

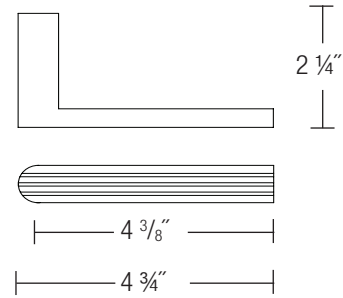

Metro (465) lever

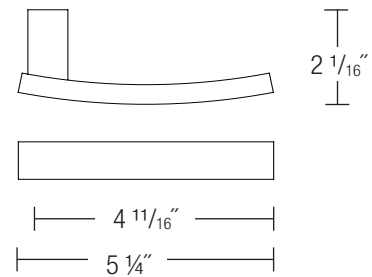

LEVER OPTIONS



Bauhaus (225) lever

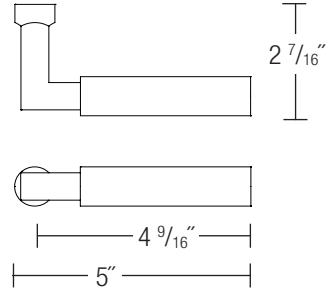

Artemis (680) lever

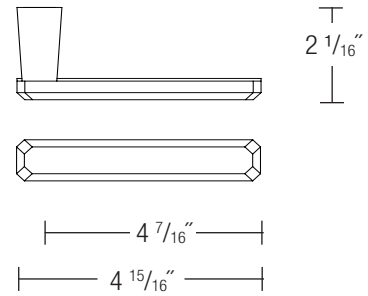

Cara (790) lever

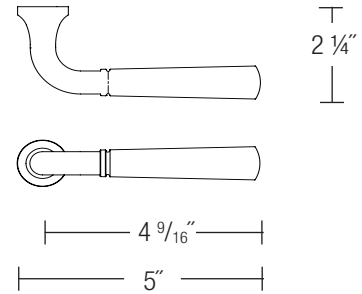

Joan (480) lever

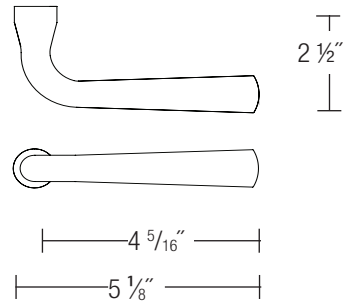

Edward (740) lever

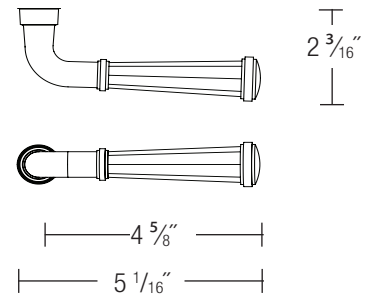

LEVER OPTIONS



Alexis (890) lever

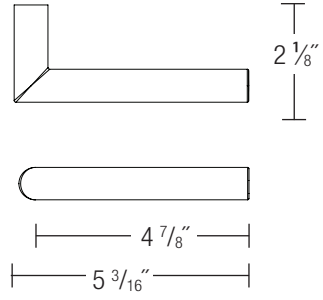

Mason (478) lever

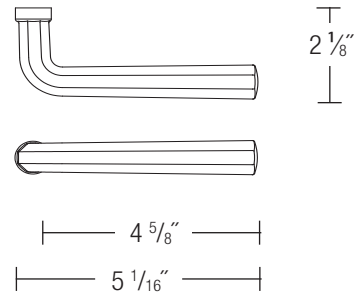

RETURN LEVER OPTIONS



Apollo Return (451) lever

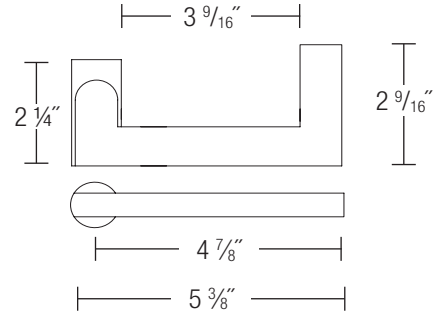

Meridian Return (311) lever

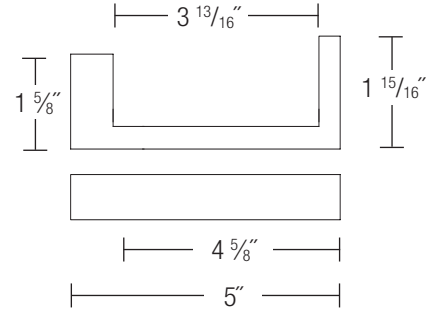

Hampton Return (401) lever

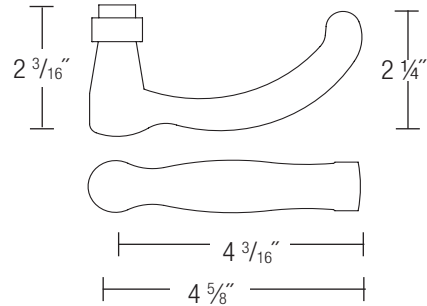

KNOB OPTIONS



Windsor (900) knob

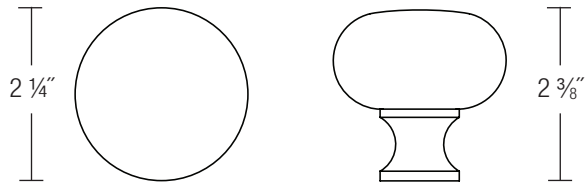

Carlisle (660) knob

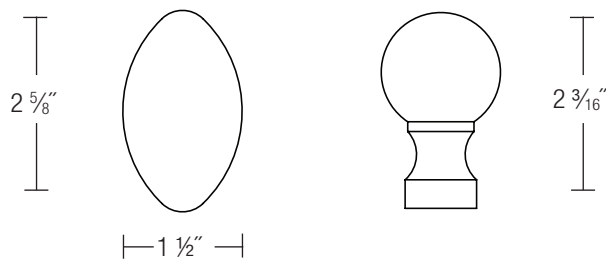

KNOB OPTIONS



Faceted (995) knob

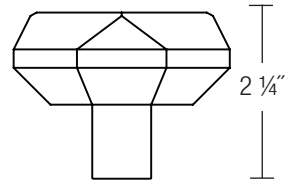
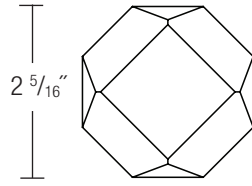

Mateo (640) knob

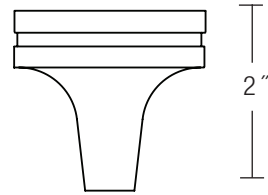
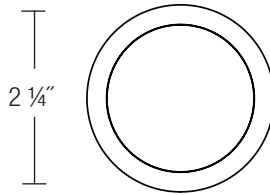

Helios (880) knob

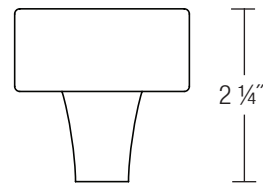
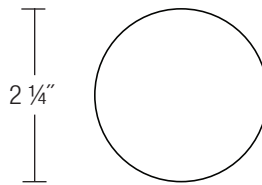

Newport (990) knob

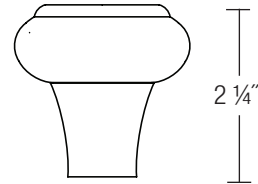
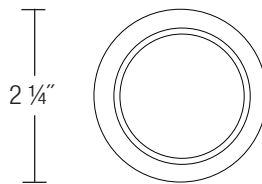

Owen (549) knob

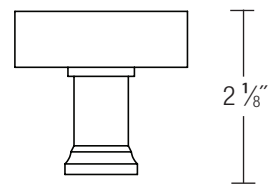
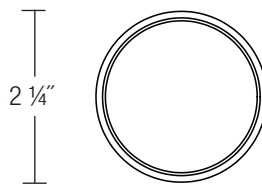



URBAN SUITE — MORTISE ENTRYSETS

MORTISE ENTRYSET ORDERING GUIDE

Patina	Escutcheon	Lever/Knob	Function	Handing	Backset
BZ Dark Bronze	select from	select from	select from	L LHR	2 1/2"
WL White Bronze	table below	pages 11-17	table across	R RHR	2 3/4"
WM White Medium					
TC Matt Black					
NB Natural Bronze					

For example to order an item in Natural Bronze (NB) patina, with the 18 1/8" x 3" grip entry escutcheon (MDSGL), the Churchill (500) lever in an Entry (10) function for a left hand door (L), use product code: NB.MDSGL.500.10.L and specify backset

- Available with any lever or knob
- ANSI F12 Entry is supplied with Accurate 9148B lock; ANSI F13 Dormitory is supplied with Accurate 9124B lock. See page 8 for further details. Other locks available on request (upcharge may apply)
- For narrow or extended backsets, please email quote request including quantities to custom@ashleynorton.com
- Specify door thickness and handing including door swing (e.g. Left, Right, Left Reverse, Right Reverse)
- For doors 2 1/2" or thicker, a \$120 list upcharge will apply
- Maximum door thickness is 3"

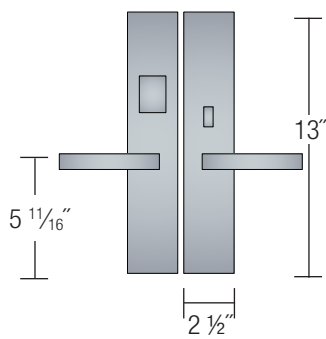

MDMOR

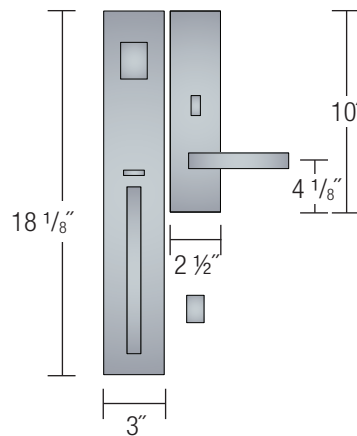

MDSGL

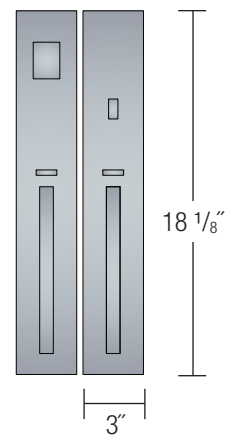



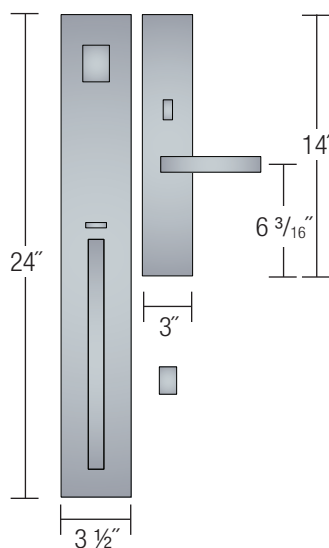



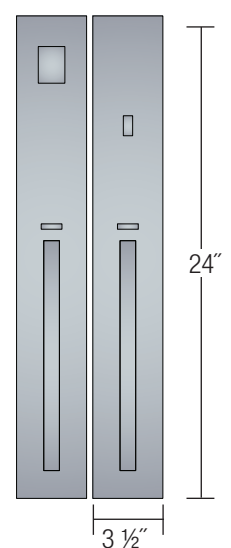

MDSGG

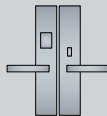
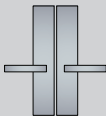
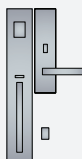
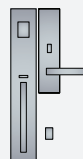

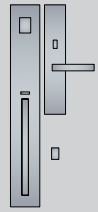
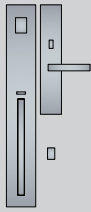
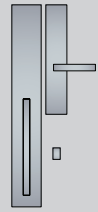
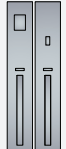
MDLGL



MDLGG

	MORTISE ENTRY ⁽¹⁾ ANSI F12	MORTISE DORMITORY ⁽¹⁾ ANSI F13	FULL DUMMY
LEVER x LEVER OR KNOB x KNOB 13 x 2 ½" PLATES Price	 MDMOR / 12 FUNCTION \$1,110.00	 MDMOR / 13 FUNCTION \$1,110.00	 MDMOR / 22 FUNCTION \$610.00
GRIP x LEVER OR GRIP x KNOB EXTERIOR: 18 ½ x 3" INTERIOR: 10 x 2 ½" Price	 MDSGL / 10 FUNCTION \$1,398.00	 MDSGL / 11 FUNCTION \$1,398.00	 MDSGL / 42 FUNCTION \$898.00
GRIP x LEVER OR GRIP x KNOB EXTERIOR: 24 x 3 ½" INTERIOR: 14 x 3" Price	 MDLGL / 10 FUNCTION \$1,612.00	 MDLGL / 11 FUNCTION \$1,612.00	 MDLGL / 42 FUNCTION \$1,112.00
GRIP x GRIP 18 ½ x 3" PLATES Price	 MDSGG / 14 FUNCTION \$1,824.00	 MDSGG / 15 FUNCTION \$1,824.00	 MDSGG / 42 FUNCTION \$1,264.00
GRIP x GRIP 24 x 3 ½" PLATES Price	 MDLGG / 14 FUNCTION \$2,176.00	 MDLGG / 15 FUNCTION \$2,176.00	 MDLGG / 42 FUNCTION \$1,616.00

(1) See page 8 for explanation of these locks.

URBAN SUITE — TUBULAR ENTRYSETS & DEADBOLTS

TUBULAR ENTRYSET ORDERING GUIDE

Patina	Escutcheon	Lever/Knob	Function	Handing	Backset
BZ Dark Bronze	select from table below	select from pages 11-17	select from table across	L Left	2 $\frac{3}{8}$ "
WL White Bronze TC Matt Black				R Right	2 $\frac{3}{4}$ "
WM White Medium NB Natural Bronze					

For example to order an item in Natural Bronze (NB) patina, with the 18 $\frac{1}{8}$ " x 3" grip entry escutcheon (MDTUB), the Apollo (450) lever in an Entry (50) function for a right hand door (R), use product code: NB.MDTUB.450.50.R and specify backset.

- Available with any lever or knob
- Suitable for doors with standard 5 $\frac{1}{2}$ " center to center
- Supplied with tubular latch and deadbolt
- Specify door thickness, handing and backset (2 $\frac{3}{8}$ " or 2 $\frac{3}{4}$ ")
- Maximum door thickness for MDTUB (grip x lever/knob entryset): 2 $\frac{1}{2}$ "
- Maximum door thickness for MDLES entryset and deadbolts: 3" for single keyed or patio, 2 $\frac{1}{4}$ " for double-keyed

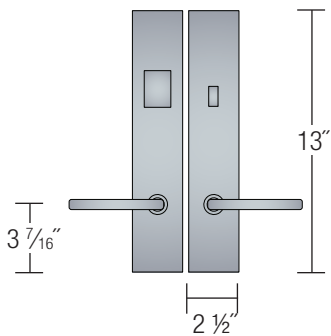

MDLES

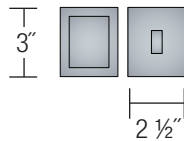

4185

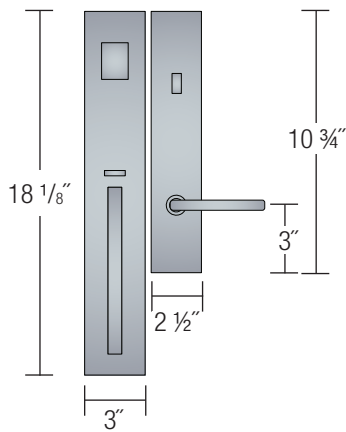

MDTUB

- Maximum door thickness 2 $\frac{1}{2}$ "

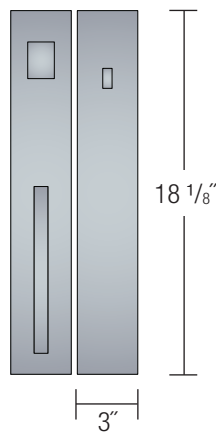





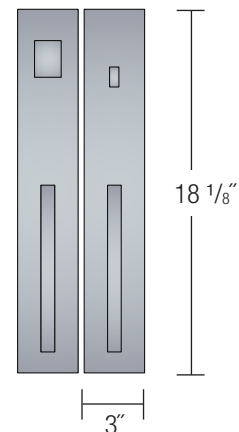





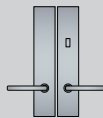

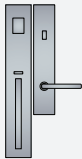
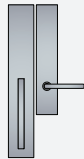
MD.GE.18

Pull/Push and Pull/Pull sets features tubular deadbolt, but no tubular latch
If latching is required, consider the MDTUB grip x lever/knob entryset



MD.GG.18

URBAN SUITE — TUBULAR ENTRYSETS & DEADBOLTS

	TUBULAR ENTRY	TUBULAR PATIO	DOUBLE ENTRY	FULL DUMMY
LEVER x LEVER OR KNOB x KNOB 13 x 2 1/2" PLATES	 MDLES / 50 FUNCTION	 MDLES / 43 FUNCTION	 MDLES / 52 FUNCTION	 MDLES / 42 FUNCTION
Price	\$688.00	\$688.00	\$744.00	\$610.00
GRIP x LEVER OR GRIP x KNOB EXTERIOR: 18 1/8 x 3" INTERIOR: 10 3/4 x 2 1/2"	 MDTUB / 50 FUNCTION			 MDTUB / 42 FUNCTION
Price	\$986.00			\$898.00
	DEADBOLT	PATIO DEADBOLT	DOUBLE KEYED DEADBOLT	FULL DUMMY
DEADBOLT 3 x 2 1/2"	 4185	 4785	 4285	
Price	\$262.00 Collar available for 1 3/8" doors and Level Bolt	\$244.00	\$308.00	
PULL x PUSH DEADBOLT⁽¹⁾ 18 1/8 x 3"	 MD.GE.18.50		 MD.GE.18.52	 MD.GE.18.42
Price	\$1,147.00		\$1,203.00	\$979.00
PULL x PULL DEADBOLT⁽¹⁾ 18 1/8 x 3"	 MD.GG.18.50		 MD.GG.18.52	 MD.GG.18.42
Price	\$1,486.00		\$1,542.00	\$1,318.00

URBAN SUITE / TUBULAR ENTRYSET

(1) Pull x Push and Pull x Pull sets feature a keyed tubular deadbolt, but not a tubular latch. If latching is required, consider a grip x lever/knob entryset. Order 4185-COLLAR if 4185 deadbolt is to be installed on 1 3/8" door, or with Level Bolt on 1 3/4" door. Price \$46.00

URBAN SUITE — PASSAGE & PRIVACY

PASSAGE & PRIVACY ORDERING GUIDE

Patina	Escutcheon	Lever/Knob	Function	Handing	Backset
BZ Dark Bronze	select from table below	select from pages 11-17	select from table across	L	2 ³ / ₈ "
WL White Bronze TC Matt Black				R	2 ³ / ₄ "
WM White Medium NB Natural Bronze					





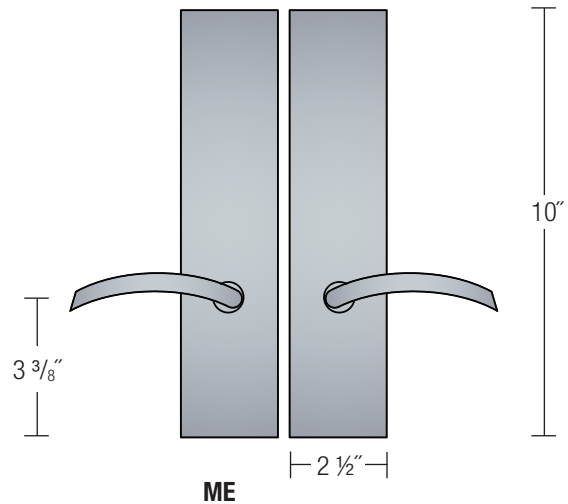
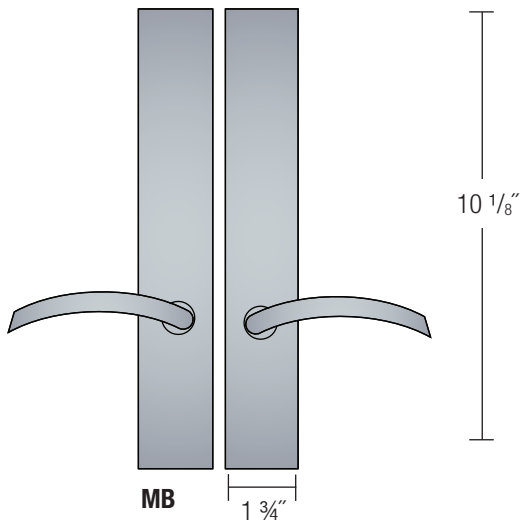
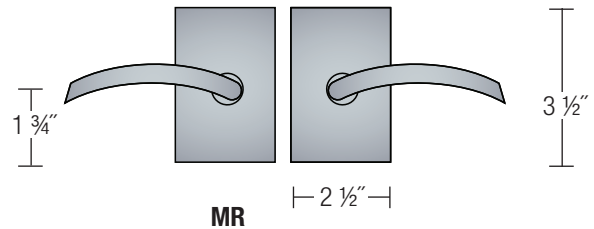
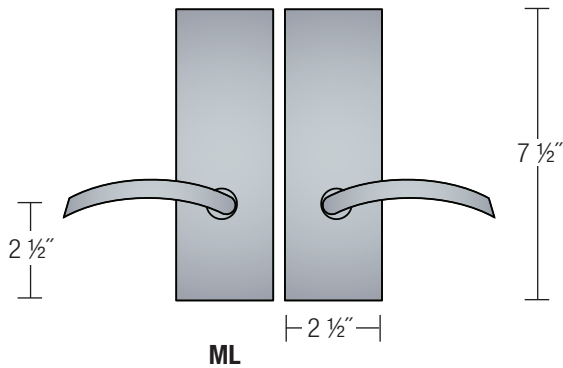
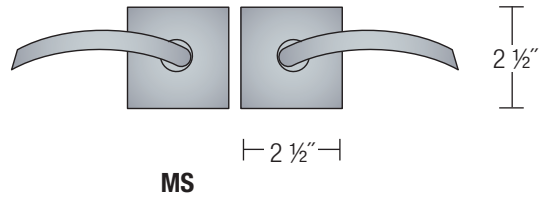
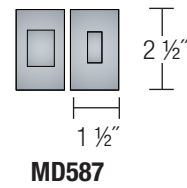
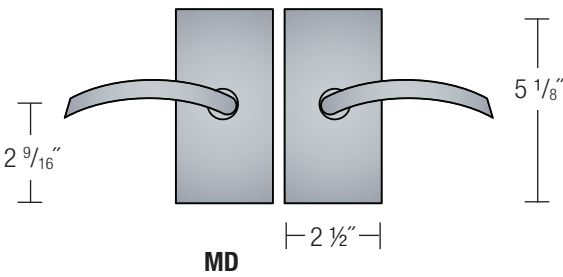





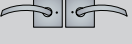















For example to order an item in Dark Bronze (BZ) patina, with the 7 1/2" x 2 1/2" escutcheon (ML), the Churchill (500) lever in a Single Dummy (40) function for a left hand door (L), use product code: BZ.ML.500.40.L

- Available with any lever or knob
- Handing not required for tubular passage and privacy sets
- Specify door thickness and backset (2 3/8" or 2 3/4" for tubular latch; 2 1/2" or 2 3/4" for interior mortise locks)
- Maximum door thickness: 3" (passage); 2 1/2" (privacy)



Will not cover 2 1/8" bore

URBAN SUITE — PASSAGE & PRIVACY

	TUBULAR PASSAGE	TUBULAR PRIVACY (PIN)	TUBULAR PRIVACY (BOLT)	MORTISE PASSAGE	MORTISE PRIVACY	SINGLE DUMMY
LEVER x LEVER OR KNOB x KNOB 2 ½ x 2 ½"	 MS 30 FUNCTION	 MS 20 FUNCTION	 MD587 PRIVACY BOLT			 MS 40 FUNCTION
Price	\$268.00	\$283.00	\$136.00			\$134.00
LEVER x LEVER OR KNOB x KNOB 3 ½ x 2 ½"	 MR 30 FUNCTION	 MR 20 FUNCTION				 MR 40 FUNCTION
Price	\$274.00	\$289.00				\$137.00
LEVER x LEVER OR KNOB x KNOB 5 ½ x 2 ½"	 MD 30 FUNCTION	 MD 20 FUNCTION				 MD 40 FUNCTION
Price	\$300.00	\$315.00				\$150.00
LEVER x LEVER OR KNOB x KNOB 7 ½ x 2 ½"	 ML 30 FUNCTION	 ML 20 FUNCTION	 ML 26 FUNCTION	 ML 34 FUNCTION	 ML 24 FUNCTION	 ML 40 FUNCTION
Price	\$358.00	\$373.00	\$418.00	\$678.00	\$698.00	\$179.00
LEVER x LEVER OR KNOB x KNOB 10 x 2 ½"	 ME 30 FUNCTION	 ME 20 FUNCTION	 ME 26 FUNCTION	 ME 34 FUNCTION	 ME 24 FUNCTION	 ME 40 FUNCTION
Price	\$446.00	\$461.00	\$506.00	\$766.00	\$786.00	\$223.00
LEVER x LEVER OR KNOB x KNOB 10 ½ x 1 ¾"	 MB 30 FUNCTION		 MB 26 FUNCTION	 MB 34 FUNCTION	 MB 24 FUNCTION	 MB 40 FUNCTION
Will not cover 2 ½" bore						
Price	\$418.00		\$478.00	\$738.00	\$758.00	\$209.00

URBAN SUITE / PASSAGE & PRIVACY SETS

Note: Ashley Norton supplies Accurate 9800 series interior locks with our mortise passage and privacy sets. Should you prefer a 3 hour UL rated, full size lock for design or code requirements, please contact us for pricing.

Note: For full dummy, order 1x LH and 1x RH single dummies

RECTANGULAR SUITE — MORTISE ENTRYSETS

MORTISE ENTRYSET ORDERING GUIDE

Patina	Escutcheon	Lever/Knob	Function	Handing	Backset
BZ Dark Bronze	select from	select from	select from	L LHR	2 1/2"
WL White Bronze TC Matt Black	table below	pages 11-17	table across	R RHR	2 3/4"
WM White Medium NB Natural Bronze					

For example to order an item in Dark Bronze (BZ) patina, with the 18 1/8" x 3" grip entry escutcheon (SQSGL), the Churchill (500) lever in an Entry (10) function for a left hand door (L), use product code: BZ.SQSGL.500.10.L and specify backset.

- Available with any lever or knob
- ANSI F12 Entry is supplied with Accurate 9148B lock; ANSI F13 Dormitory is supplied with Accurate 9124B lock. See page 8 for further details. Other locks available on request (upcharge may apply)
- For narrow or extended backsets, please email quote request including quantities to custom@ashleynorton.com
- Specify door thickness and handing including door swing (e.g. Left, Right, Left Reverse, Right Reverse)
- For doors 2 1/2" or thicker, a \$120 list upcharge will apply
- Maximum door thickness is 3"

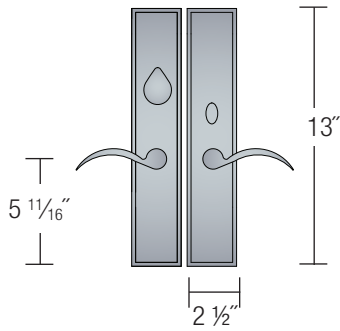

SQMOR

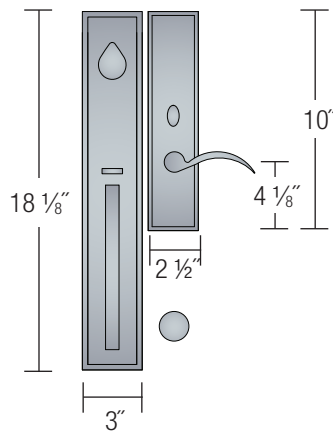

SQSGL

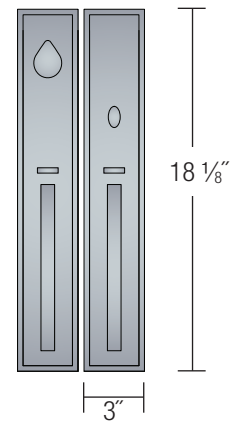



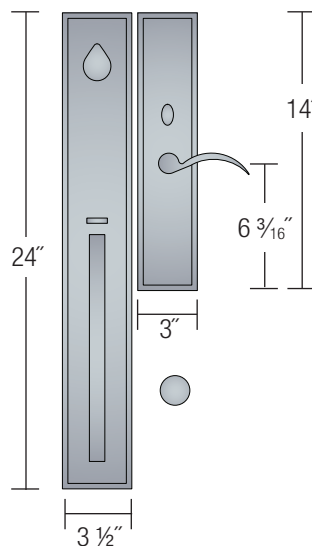



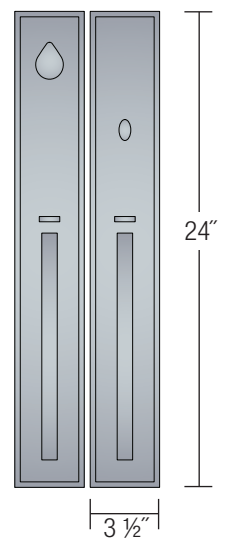

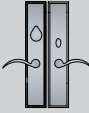

SQSGG

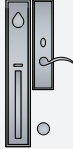
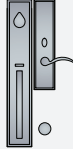
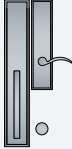
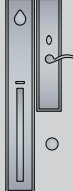
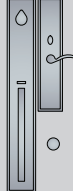

SQLGL



SQLGG

	MORTISE ENTRY ⁽¹⁾ ANSI F12	MORTISE DORMITORY ⁽¹⁾ ANSI F13	FULL DUMMY
LEVER x LEVER OR KNOB x KNOB 13 x 2 ½" PLATES Price	 SQMOR / 12 FUNCTION \$1,110.00	 SQMOR / 13 FUNCTION \$1,110.00	 SQMOR / 22 FUNCTION \$610.00
GRIP x LEVER OR GRIP x KNOB EXTERIOR: 18 ½ x 3" INTERIOR: 10 x 2 ½" Price	 SQSG L / 10 FUNCTION \$1,398.00	 SQSG L / 11 FUNCTION \$1,398.00	 SQSG L / 42 FUNCTION \$898.00
GRIP x LEVER OR GRIP x KNOB EXTERIOR: 24 x 3 ½" INTERIOR: 14 x 3" Price	 SQLGL / 10 FUNCTION \$1,612.00	 SQLGL / 11 FUNCTION \$1,612.00	 SQLGL / 42 FUNCTION \$1,112.00
GRIP x GRIP 18 ½ x 3" PLATES Price	 SQSGG / 14 FUNCTION \$1,824.00	 SQSGG / 15 FUNCTION \$1,824.00	 SQSGG / 42 FUNCTION \$1,264.00
GRIP x GRIP 24 x 3 ½" PLATES Price	 SQLGG / 14 FUNCTION \$2,176.00	 SQLGG / 15 FUNCTION \$2,176.00	 SQLGG / 42 FUNCTION \$1,616.00

RECTANGULAR SUITE / MORTISE ENTRYSET

(1) See page 8 for explanation of these locks.

RECTANGULAR SUITE - TUBULAR ENTRYSETS & DEADBOLTS

TUBULAR ENTRYSET ORDERING GUIDE

Patina	Escutcheon	Lever/Knob	Function	Handing	Backset
BZ Dark Bronze	select from table below	select from pages 11-17	select from table across	L Left	2 ³ / ₈ "
WL White Bronze TC Matt Black				R Right	2 ³ / ₄ "
WM White Medium NB Natural Bronze					

For example to order an item in Natural Bronze (NB) patina, with the 18 ¹/₈" x 3" grip entry escutcheon (SQTUB), the Chester (200) lever in an Entry (50) function for a right hand door (R), use product code: NB.SQTUB.200.50.R and specify backset

- Available with any lever or knob
- Suitable for doors with standard 5 ¹/₂" center to center
- Supplied with tubular latch and deadbolt
- Specify door thickness, handing and backset (2 ³/₈" or 2 ³/₄"
- Maximum door thickness for SQTUB (grip x lever/knob entryset): 2 ¹/₂"
- Maximum door thickness for SQLES entryset and deadbolts: 3" for single keyed or patio, 2 ¹/₄" for double-keyed

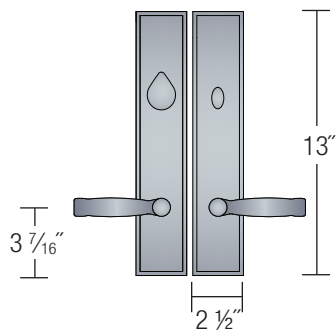

SQLES

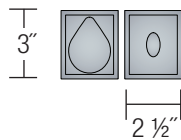

4150

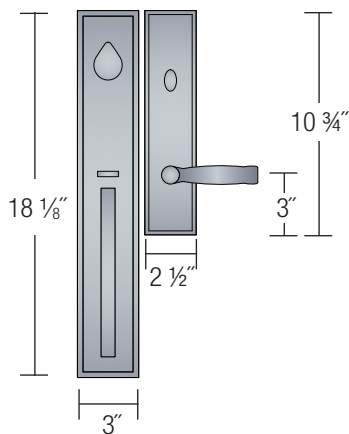

SQTUB

- Maximum door thickness 2 ¹/₂"

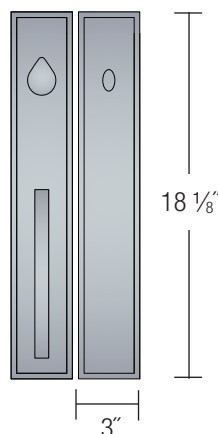





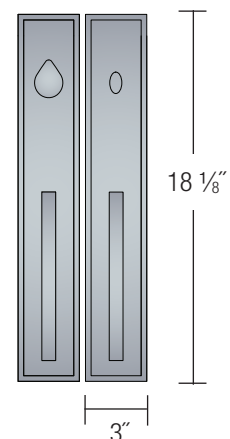





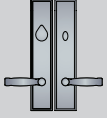

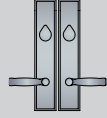

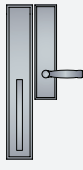
SQ.GE.18

Pull/Push and Pull/Pull sets features tubular deadbolt, but no tubular latch
If latching is required, consider the SQTUB grip x lever/knob entryset



SQ.GG.18

RECTANGULAR SUITE - TUBULAR ENTRYSETS & DEADBOLTS

	TUBULAR ENTRY	TUBULAR PATIO	DOUBLE ENTRY	FULL DUMMY
LEVER x LEVER OR KNOB x KNOB 13 x 2 1/2" PLATES Price	 SQLES / 50 FUNCTION \$688.00	 SQLES / 43 FUNCTION \$688.00	 SQLES / 52 FUNCTION \$744.00	 SQLES / 42 FUNCTION \$610.00
GRIP x LEVER OR GRIP x KNOB EXTERIOR: 18 1/8 x 3" INTERIOR: 10 3/4 x 2 1/2" Price	 SQTUB / 50 FUNCTION \$986.00			 SQTUB / 42 FUNCTION \$898.00
	DEADBOLT	PATIO BOLT	DOUBLE KEYED DEADBOLT	FULL DUMMY
DEADBOLT 3 x 2 1/2" Price	 4150 \$262.00 Collar available for 1 3/8" doors and Level Bolt	 4750 \$244.00	 4250 \$308.00	
PULL x PUSH DEADBOLT⁽¹⁾ 18 1/8 x 3" Price	 SQ.GE.18.50 \$1,147.00		 SQ.GE.18.52 \$1,203.00	 SQ.GE.18.42 \$979.00
PULL x PULL DEADBOLT⁽¹⁾ 18 1/8 x 3" Price	 SQ.GG.18.50 \$1,486.00		 SQ.GG.18.52 \$1,542.00	 SQ.GG.18.42 \$1,318.00

RECTANGULAR SUITE / TUBULAR ENTRYSET & DEADBOLTS

(1) Pull x Push and Pull x Pull sets feature a keyed tubular deadbolt, but not a tubular latch. If latching is required, consider a grip x lever/knob entryset. Order 4185-COLLAR if 4150 deadbolt is to be installed on 1 3/8" door, or with Level Bolt on 1 3/4" door. Price \$46.00

RECTANGULAR SUITE — PASSAGE & PRIVACY

PASSAGE & PRIVACY ORDERING GUIDE

Patina	Escutcheon	Lever/Knob	Function	Handing	Backset
BZ Dark Bronze	select from table below	select from pages 11-17	select from table across	L	2 ³ / ₈ "
WL White Bronze				R	2 ³ / ₄ "
TC Matt Black					
WM White Medium					
NB Natural Bronze					





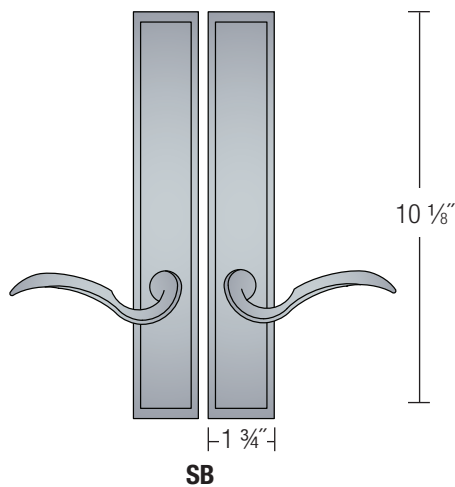
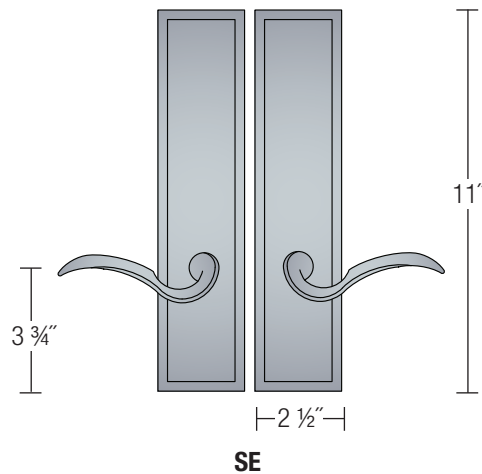
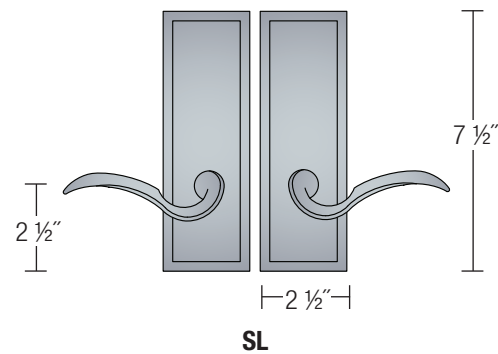
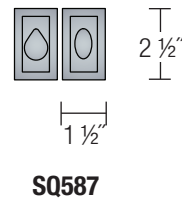
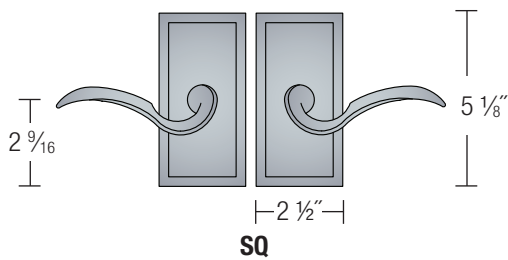









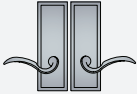

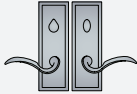

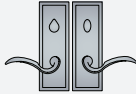
For example to order an item in White Bronze (WL) patina, with the 5 1/8" x 2 1/2" escutcheon (SQ), the Hampton (400) lever in a Single Dummy (40) function for a left hand door (L), use product code: WL.SQ.400.40.L

- Available with any lever or knob
- Handing not required for tubular passage or privacy sets
- Specify door thickness and backset (2 3/8" or 2 3/4" for tubular latch; 2 1/2" or 2 3/4" for interior mortise locks)
- Maximum door thickness: 3" (passage); 2 1/2" (privacy)

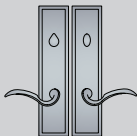

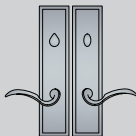
Will not cover 2 1/8" bore

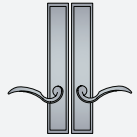
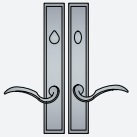
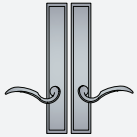
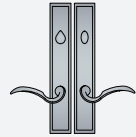
RECTANGULAR SUITE — PASSAGE & PRIVACY

	TUBULAR PASSAGE	TUBULAR PRIVACY (PIN)	TUBULAR PRIVACY (BOLT)	MORTISE PASSAGE	MORTISE PRIVACY	SINGLE DUMMY
LEVER x LEVER OR KNOB x KNOB 5 1/8 x 2 1/2" PLATES	 SQ 30 FUNCTION	 SQ 20 FUNCTION	 SQ587 PRIVACY BOLT			 SQ 40 FUNCTION
Price	\$300.00	\$315.00	\$136.00			\$150.00
LEVER x LEVER OR KNOB x KNOB 7 1/2 x 2 1/2" PLATES	 SL 30 FUNCTION	 SL 20 FUNCTION	 SL 26 FUNCTION	 SL 34 FUNCTION	 SL 24 FUNCTION	 SL 40 FUNCTION
Price	\$358.00	\$373.00	\$418.00	\$678.00	\$698.00	\$179.00
LEVER x LEVER OR KNOB x KNOB 11 x 2 1/2" PLATES	 SE 30 FUNCTION	 SE 20 FUNCTION	 SE 26 FUNCTION	 SE 34 FUNCTION	 SE 24 FUNCTION	 SE 40 FUNCTION
Price	\$446.00	\$461.00	\$506.00	\$766.00	\$786.00	\$223.00
LEVER x LEVER OR KNOB x KNOB 10 1/8 x 1 3/4" Will not cover 2 1/8" bore	 SB 30 FUNCTION		 SB 26 FUNCTION	 SB 34 FUNCTION	 SB 24 FUNCTION	 SB 40 FUNCTION
Price	\$418.00		\$478.00	\$738.00	\$758.00	\$209.00

RECTANGULAR SUITE / PASSAGE & PRIVACY SETS

Note: Ashley Norton supplies Accurate 9800 series interior locks with our mortise passage and privacy sets. Should you prefer a 3 hour UL rated, full size lock for design or code requirements, please contact us for pricing.

Note: For full dummy, order 1x LH and 1x RH single dummies

ARCHED SUITE — MORTISE ENTRYSETS

MORTISE ENTRYSET ORDERING GUIDE

Patina	Escutcheon	Lever/Knob	Function	Handing	Backset
BZ Dark Bronze	select from	select from	select from	L LHR	2 1/2"
WL White Bronze TC Matt Black	table below	pages 11-17	table across	R RHR	2 3/4"
WM White Medium NB Natural Bronze					

For example to order an item in Dark Bronze (BZ) patina, with the 18 1/8" x 3" grip entry escutcheon (SPSGL), the Churchill (500) lever in an Entry (10) function for a left hand door (L), use product code: BZ.SPSGL.500.10.L and specify backset

- Available with any lever or knob
- ANSI F12 Entry is supplied with Accurate 9148B lock; ANSI F13 Dormitory is supplied with Accurate 9124B lock. See page 8 for further details. Other locks available on request (upcharge may apply)
- For narrow or extended backsets, please email quote request including quantities to custom@ashleynorton.com
- Specify door thickness and handing including door swing (e.g. Left, Right, Left Reverse, Right Reverse)
- For doors 2 1/2" or thicker, a \$120 list upcharge will apply
- Maximum door thickness is 3"

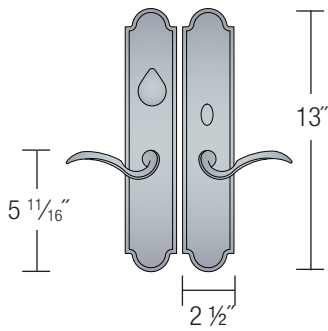

SPMOR

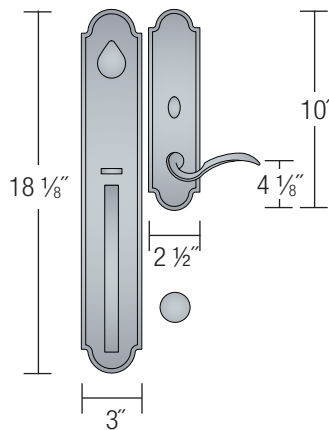

SPSGL

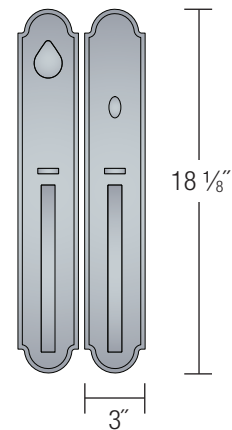



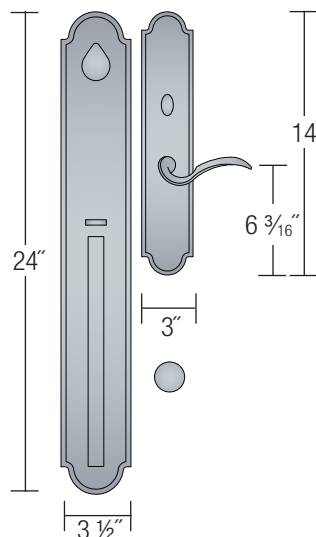



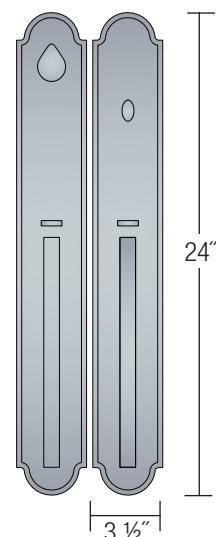

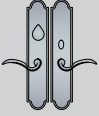
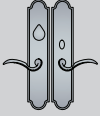
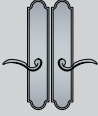
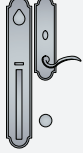
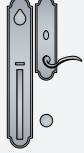
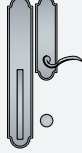

SPSGG

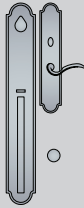

SPLGL



SPLGG

	MORTISE ENTRY ⁽¹⁾ ANSI F12	MORTISE DORMITORY ⁽¹⁾ ANSI F13	FULL DUMMY
LEVER x LEVER OR KNOB x KNOB 13 x 2 ½" PLATES Price	 SPMOR / 12 FUNCTION \$1,110.00	 SPMOR / 13 FUNCTION \$1,110.00	 SPMOR / 22 FUNCTION \$610.00
GRIP x LEVER OR GRIP x KNOB EXTERIOR: 18 ½ x 3" INTERIOR: 10 x 2 ½" Price	 SPSGL / 10 FUNCTION \$1,398.00	 SPSGL / 11 FUNCTION \$1,398.00	 SPSGL / 42 FUNCTION \$898.00
GRIP x LEVER OR GRIP x KNOB EXTERIOR: 24 x 3 ½" INTERIOR: 14 x 3" Price	 SPLGL / 10 FUNCTION \$1,612.00	 SPLGL / 11 FUNCTION \$1,612.00	 SPLGL / 42 FUNCTION \$1,112.00
GRIP x GRIP 18 ½ x 3" PLATES Price	 SPSGG / 14 FUNCTION \$1,824.00	 SPSGG / 15 FUNCTION \$1,824.00	 SPSGG / 42 FUNCTION \$1,264.00
GRIP x GRIP 24 x 3 ½" PLATES Price	 SPLGG / 14 FUNCTION \$2,176.00	 SPLGG / 15 FUNCTION \$2,176.00	 SPLGG / 42 FUNCTION \$1,616.00

ARCHED SUITE / MORTISE ENTRYSET

(1) See page 8 for explanation of these locks.

ARCHED SUITE — TUBULAR ENTRYSETS & DEADBOLTS

TUBULAR ENTRYSET ORDERING GUIDE

Patina	Escutcheon	Lever/Knob	Function	Handing	Backset
BZ Dark Bronze	select from table below	select from pages 11-17	select from table across	L Left	2 ³ / ₈ "
WL White Bronze TC Matt Black				R Right	2 ³ / ₄ "
WM White Medium NB Natural Bronze					

For example to order an item in Matt Black (TC) patina, with the 18 ¹/₈" x 3" grip entry escutcheon (SPTUB), the Shropshire (800) lever in an Dummy (42) function for a left hand door (L), use product code: TC.SPTUB.800.42.L

- Available with any lever or knob
- Suitable for doors with standard 5 ¹/₂" center to center
- Supplied with tubular latch and deadbolt
- Specify door thickness, handing and backset (2 ³/₈" or 2 ³/₄")
- Maximum door thickness for SPTUB (grip x lever/knob entryset): 2 ¹/₂"
- Maximum door thickness for SPLES entryset and deadbolts: 3" for single keyed or patio, 2 ¹/₄" for double-keyed

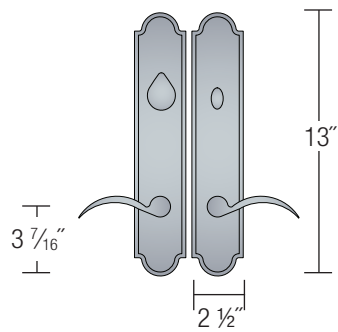

SPLES

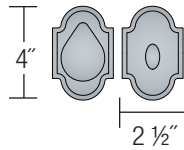

4165

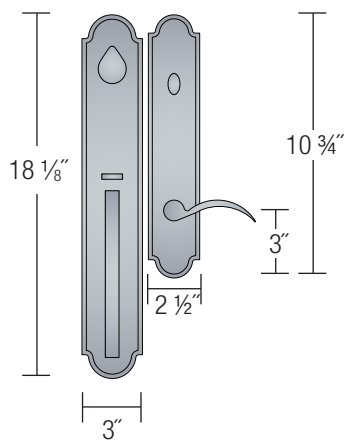

SPTUB

- Maximum door thickness 2 ¹/₂"

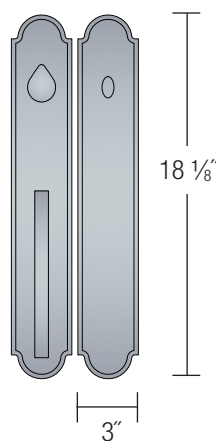





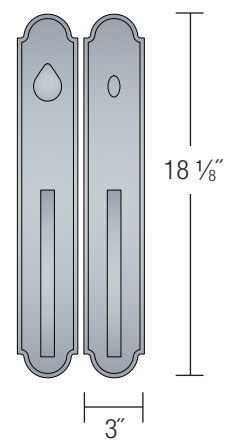





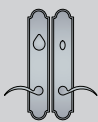
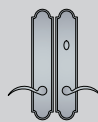
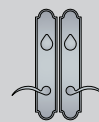
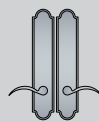

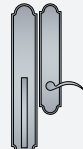
SP.GE.18

Pull/Push and Pull/Pull sets features tubular deadbolt, but no tubular latch
If latching is required, consider the SPTUB grip x lever/knob entryset

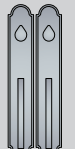

SP.GG.18

ARCHED SUITE — TUBULAR ENTRYSETS & DEADBOLTS

	TUBULAR ENTRY	TUBULAR PATIO	DOUBLE ENTRY	FULL DUMMY
LEVER x LEVER OR KNOB x KNOB 13 x 2 1/2" PLATES	 SPLES / 50 FUNCTION	 SPLES / 43 FUNCTION	 SPLES / 52 FUNCTION	 SPLES / 42 FUNCTION
Price	\$688.00	\$688.00	\$744.00	\$610.00
GRIP x LEVER OR GRIP x KNOB EXTERIOR: 18 1/8 x 3" INTERIOR: 10 3/4 x 2 1/2"	 SPTUB / 50 FUNCTION			 SPTUB / 42 FUNCTION
Price	\$986.00			\$898.00
	DEADBOLT	PATIO DEADBOLT	DOUBLE KEYED DEADBOLT	FULL DUMMY
DEADBOLT 4 x 2 1/2"	 4165	 4765	 4265	
Price	\$262.00 <small>Collar available for 1 3/8" doors and Level Bolt</small>	\$244.00	\$308.00	
PULL x PUSH DEADBOLT⁽¹⁾ 18 1/8 x 3"	 SP.GE.18.50		 SP.GE.18.52	 SP.GE.18.42
Price	\$1,147.00		\$1,203.00	\$979.00
PULL x PULL DEADBOLT⁽¹⁾ 18 1/8 x 3"	 SP.GG.18.50		 SP.GG.18.52	 SP.GG.18.42
Price	\$1,486.00		\$1,542.00	\$1,318.00

ARCHED SUITE / TUBULAR ENTRYSET

(1) Pull x Push and Pull x Pull sets feature a keyed tubular deadbolt, but not a tubular latch. If latching is required, consider a grip x lever/knob entryset. Order 4165-COLLAR if 4165 deadbolt is to be installed on 1 3/8" door, or with Level Bolt on 1 3/4" door. Price \$46.00

ARCHED SUITE — PASSAGE & PRIVACY

PASSAGE & PRIVACY ORDERING GUIDE

Patina	Escutcheon	Lever/Knob	Function	Handing	Backset
BZ Dark Bronze	select from	select from	select from	L	2 3/8"
WL White Bronze	table below	pages 11-17	table across	R	2 3/4"
WM White Medium					
TC Matt Black					
NB Natural Bronze					



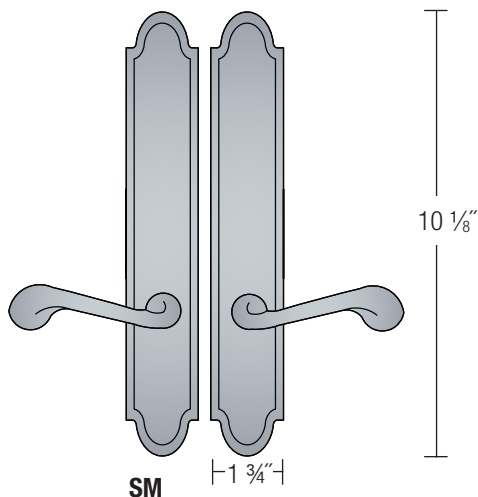
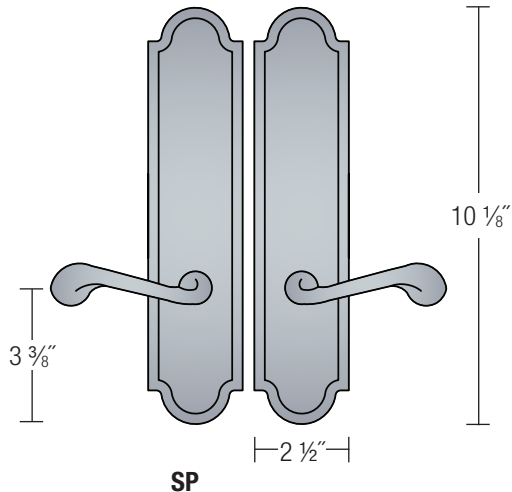
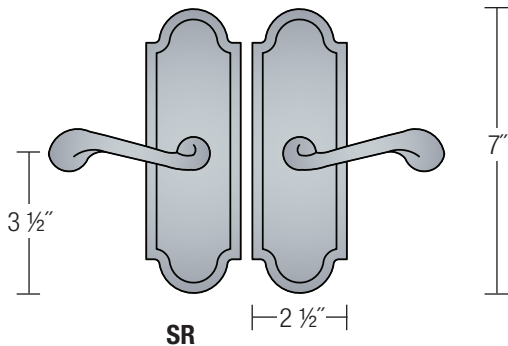
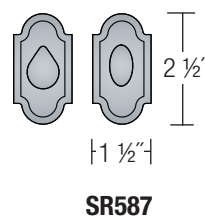
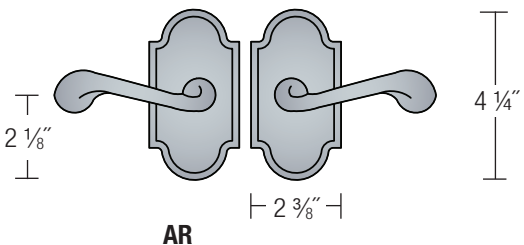

For example to order an item in Dark Bronze (BZ) patina, with the small arched escutcheon (AR), the Churchill (500) lever in a Passage (30) function, use product code: BZ.AR.500.30 and specify backset.

- Handing not required for tubular passage and privacy sets
- Specify door thickness and backset (2 3/8" or 2 3/4" for tubular latch; 2 1/2" or 2 3/4" for interior mortise locks)
- Maximum door thickness: 3" (passage); 2 1/2" (privacy)

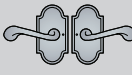

Will not cover 2 1/8" bore

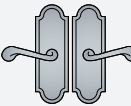
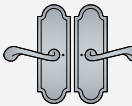
ARCHED SUITE — PASSAGE & PRIVACY

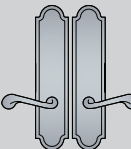
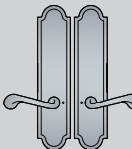
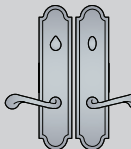
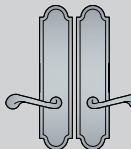
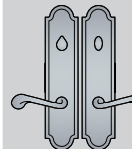
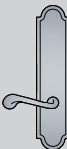
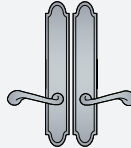
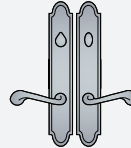
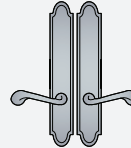
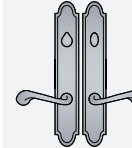
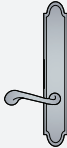
	TUBULAR PASSAGE	TUBULAR PRIVACY (PIN)	TUBULAR PRIVACY (BOLT)	MORTISE PASSAGE	MORTISE PRIVACY	SINGLE DUMMY
LEVER x LEVER OR KNOB x KNOB 4 ¼ x 2 ¾" PLATES Price	 AR 30 FUNCTION \$274.00	 AR 20 FUNCTION \$289.00	 SR587 PRIVACY BOLT \$136.00			 AR 40 FUNCTION \$137.00
LEVER x LEVER OR KNOB x KNOB 7 x 2 ½" PLATES Price	 SR 30 FUNCTION \$358.00	 SR 20 FUNCTION \$373.00				 SR 40 FUNCTION \$179.00
LEVER x LEVER OR KNOB x KNOB 10 ½ x 2 ½" PLATES Price	 SP 30 FUNCTION \$446.00	 SP 20 FUNCTION \$461.00	 SP 26 FUNCTION \$506.00	 SP 34 FUNCTION \$766.00	 SP 24 FUNCTION \$786.00	 SP 40 FUNCTION \$223.00
LEVER x LEVER OR KNOB x KNOB 10 ½ x 1 ¾" Will not cover 2 ½" bore Price	 SM 30 FUNCTION \$418.00		 SM 26 FUNCTION \$478.00	 SM 34 FUNCTION \$738.00	 SM 24 FUNCTION \$758.00	 SM 40 FUNCTION \$209.00

ARCHED SUITE / PASSAGE & PRIVACY SETS

Note: Ashley Norton supplies Accurate 9800 series interior locks with our mortise passage and privacy sets. Should you prefer a 3 hour UL rated, full size lock for design or code requirements, please contact us for pricing.

Note: For full dummy, order 1x LH and 1x RH single dummies

CURVED SUITE — MORTISE ENTRYSETS

MORTISE ENTRYSET ORDERING GUIDE

Patina	Escutcheon	Lever/Knob	Function	Handing	Backset
BZ Dark Bronze	select from	select from	select from	L LHR	2 ½"
WL White Bronze	TC Matt Black	pages 11-17	table across	R RHR	2 ¾"
WM White Medium	NB Natural Bronze				

For example to order an item in White Bronze (WL) patina, with the 24" x 3 ½" grip entry escutcheon (CVLGL), the Apollo (450) lever in an Entry (10) function for a right hand door (R), use product code: WL.CVLGL.450.10.R and specify backset

- Available with any lever or knob
- ANSI F12 Entry is supplied with Accurate 9148B lock; ANSI F13 Dormitory is supplied with Accurate 9124B lock. See page 8 for further details. Other locks available on request (upcharge may apply)
- For narrow or extended backsets, please email quote request including quantities to custom@ashleynorton.com
- Specify door thickness and handing including door swing (e.g. Left, Right, Left Reverse, Right Reverse)
- For doors 2 ½" or thicker, a \$120 list upcharge will apply
- Maximum door thickness is 3"

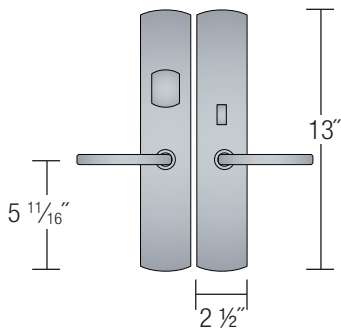

CVMOR

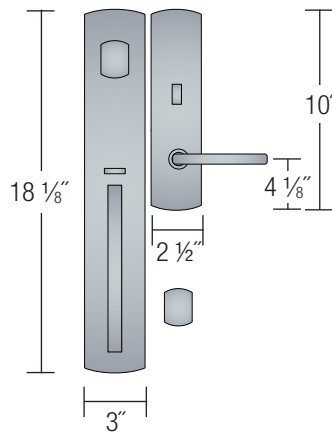

CVSGL

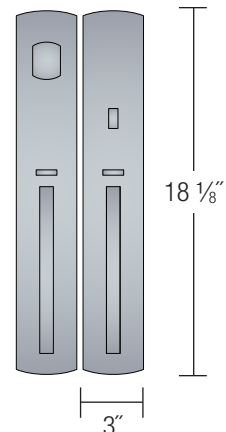



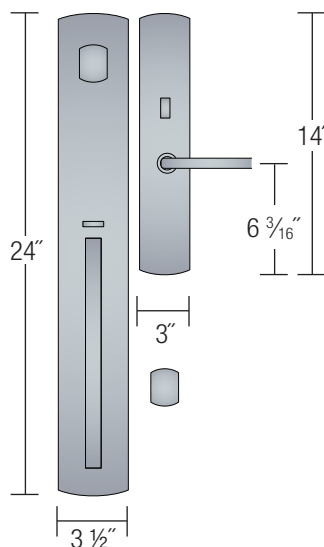



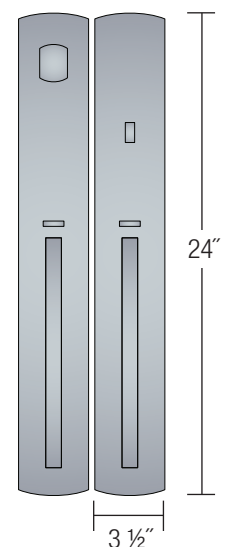

CVSGLG

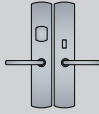
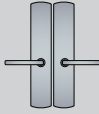
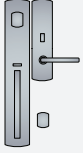
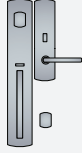
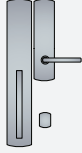
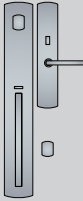

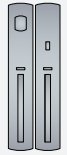
CVLGL



CVLGLG

	MORTISE ENTRY ⁽¹⁾ ANSI F12	MORTISE DORMITORY ⁽¹⁾ ANSI F13	FULL DUMMY
LEVER x LEVER OR KNOB x KNOB 13 x 2 ½" PLATES Price	 CVMOR / 12 FUNCTION \$1,110.00	 CVMOR / 13 FUNCTION \$1,110.00	 CVMOR / 22 FUNCTION \$610.00
GRIP x LEVER OR GRIP x KNOB EXTERIOR: 18 ½ x 3" INTERIOR: 10 x 2 ½" Price	 CVSGL / 10 FUNCTION \$1,398.00	 CVSGL / 11 FUNCTION \$1,398.00	 CVSGL / 42 FUNCTION \$898.00
GRIP x LEVER OR GRIP x KNOB EXTERIOR: 24 x 3 ½" INTERIOR: 14 x 3" Price	 CVLGL / 10 FUNCTION \$1,612.00	 CVLGL / 11 FUNCTION \$1,612.00	 CVLGL / 42 FUNCTION \$1,112.00
GRIP x GRIP 18 ½ x 3" PLATES Price	 CVSGG / 14 FUNCTION \$1,824.00	 CVSGG / 15 FUNCTION \$1,824.00	 CVSGG / 42 FUNCTION \$1,264.00
GRIP x GRIP 24 x 3 ½" PLATES Price	 CVLGG / 14 FUNCTION \$2,176.00	 CVLGG / 15 FUNCTION \$2,176.00	 CVLGG / 42 FUNCTION \$1,616.00

CURVED SUITE / MORTISE ENTRYSET

(1) See page 8 for explanation of these locks.

CURVED SUITE — TUBULAR ENTRYSETS & DEADBOLTS

TUBULAR ENTRYSET ORDERING GUIDE

Patina	Escutcheon	Lever/Knob	Function	Handing	Backset
BZ Dark Bronze	select from	select from	select from	L Left	2 3/8"
WL White Bronze TC Matt Black	table below	pages 11-17	table across	R Right	2 3/4"
WM White Medium NB Natural Bronze					

For example to order an item in White Bronze (WL) patina, with the 13" x 2 1/2" lever x lever escutcheon (CVLES), the Greenwich (350) lever in an Patio (43) function for a right hand door (R), use product code: WL.CVLES.350.43.R and specify backset

- Available with any lever or knob
- Suitable for doors with standard 5 1/2" center to center
- Supplied with tubular latch and deadbolt
- Specify door thickness, handing and backset (2 3/8" or 2 3/4")
- Maximum door thickness for CVTUB (grip x lever/knob entryset): 2 1/2"
- Maximum door thickness for CVLES entryset and deadbolts: 3" for single keyed or patio, 2 1/4" for double-keyed

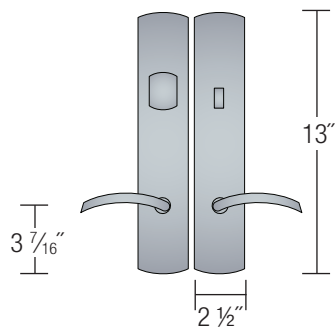

CVLES

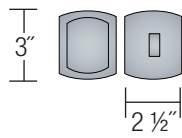

4175

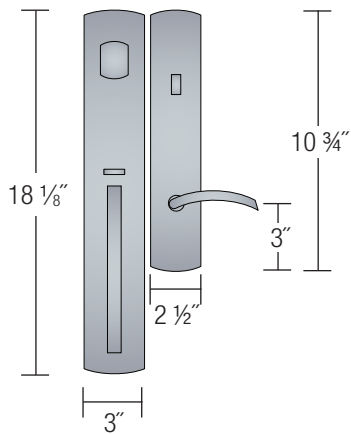

CVTUB

- Maximum door thickness 2 1/2"

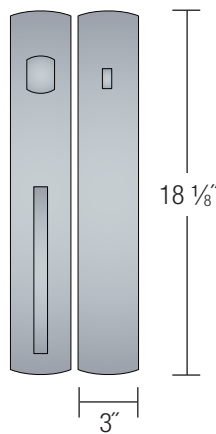





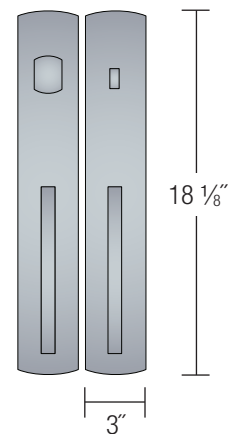







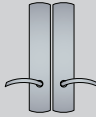

CV.GE.18

Pull/Push and Pull/Pull sets features tubular deadbolt, but no tubular latch
If latching is required, consider the CVTUB grip x lever/knob entryset



CV.GG.18

CURVED SUITE — TUBULAR ENTRYSETS & DEADBOLTS

	KEYED ENTRY	PATIO	DOUBLE ENTRY	FULL DUMMY
LEVER x LEVER OR KNOB x KNOB 13 x 2½" PLATES	 CVLES / 50 FUNCTION	 CVLES / 43 FUNCTION	 CVLES / 52 FUNCTION	 CVLES / 42 FUNCTION
Price	\$688.00	\$688.00	\$744.00	\$610.00
GRIP x LEVER OR GRIP x KNOB EXTERIOR: 18½ x 3" INTERIOR: 10¾ x 2½"	 CVTUB / 50 FUNCTION			 CVTUB / 42 FUNCTION
Price	\$986.00			\$898.00
	DEADBOLT	PATIO DEADBOLT	DOUBLE KEYED DEADBOLT	FULL DUMMY
DEADBOLT 3 x 2½"	 4175	 4775	 4275	
Price	\$262.00 Collar available for 1 3/8" doors and Level Bolt	\$244.00	\$308.00	
PULL x PUSH DEADBOLT⁽¹⁾ 18½ x 3"	 CV.GE.18.50		 CV.GE.18.52	 CV.GE.18.42
Price	\$1,147.00		\$1,203.00	\$979.00
PULL x PULL DEADBOLT⁽¹⁾ 18½ x 3"	 CV.GG.18.50		 CV.GG.18.52	 CV.GG.18.42
Price	\$1,486.00		\$1,542.00	\$1,318.00

CURVED SUITE / TUBULAR ENTRY SET

(1) Pull x Push and Pull x Pull sets feature a keyed tubular deadbolt, but not a tubular latch. If latching is required, consider a grip x lever/knob entryset. Order 4175-COLLAR if 4175 deadbolt is to be installed on 1 3/8" door, or with Level Bolt on 1 3/4" door. Price \$46.00

CURVED SUITE — PASSAGE & PRIVACY

PASSAGE & PRIVACY ORDERING GUIDE

Patina	Escutcheon	Lever/Knob	Function	Handing	Backset
BZ Dark Bronze	select from table below	select from pages 11-17	select from table across	L R	2 ³ / ₈ "
WL White Bronze TC Matt Black					2 ³ / ₄ "
WM White Medium NB Natural Bronze					





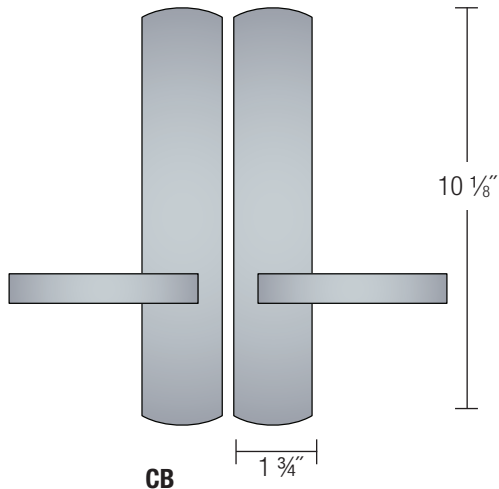
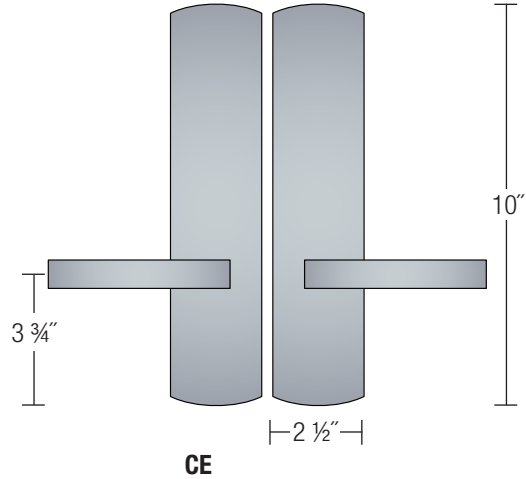
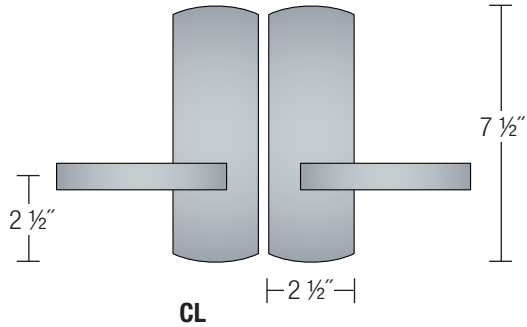
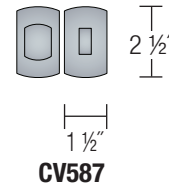
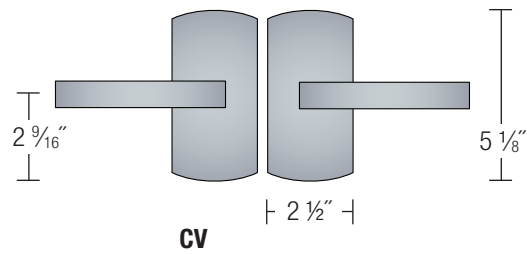

For example to order an item in Dark Bronze (BZ) patina, with the 10" x 2 1/2" escutcheon (CE), the Centaur (349) lever in a Single Dummy (40) function for a left hand door (L), use product code: BZ.CE.349.40.L

- Available with any lever or knob
- Handing not required for tubular passage and privacy sets
- Specify door thickness and backset (2 3/8" or 2 3/4" for tubular latch; 2 1/2" or 2 3/4" for interior mortise locks)
- Maximum door thickness: 3" (passage); 2 1/2" (privacy)

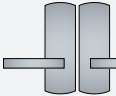
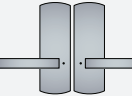
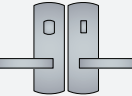
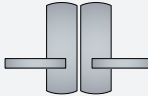
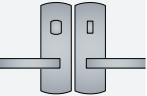

Will not cover 2 1/8" bore

CURVED SUITE — PASSAGE & PRIVACY

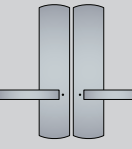
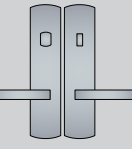
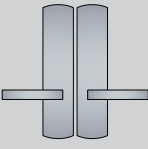
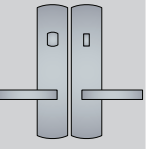
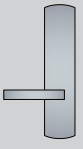
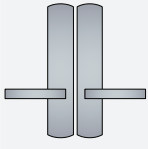
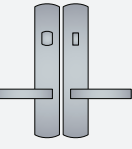
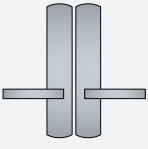
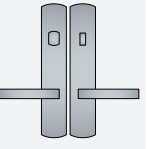
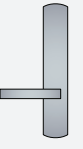
	TUBULAR PASSAGE	TUBULAR PRIVACY (PIN)	TUBULAR PRIVACY (BOLT)	MORTISE PASSAGE	MORTISE PRIVACY	SINGLE DUMMY
LEVER x LEVER OR KNOB x KNOB 5 1/8 x 2 1/2" PLATES Price	 CV 30 FUNCTION \$300.00	 CV 20 FUNCTION \$315.00	 CV587 PRIVACY BOLT \$136.00			 CV 40 FUNCTION \$150.00
LEVER x LEVER OR KNOB x KNOB 7 1/2 x 2 1/2" PLATES Price	 CL 30 FUNCTION \$358.00	 CL 20 FUNCTION \$373.00	 CL 26 FUNCTION \$418.00	 CL 34 FUNCTION \$678.00	 CL 24 FUNCTION \$698.00	 CL 40 FUNCTION \$179.00
LEVER x LEVER OR KNOB x KNOB 10 x 2 1/2" PLATES Price	 CE 30 FUNCTION \$446.00	 CE 20 FUNCTION \$461.00	 CE 26 FUNCTION \$506.00	 CE 34 FUNCTION \$766.00	 CE 24 FUNCTION \$786.00	 CE 40 FUNCTION \$223.00
LEVER x LEVER OR KNOB x KNOB 10 1/8 x 1 3/4" Will not cover 2 1/8" bore Price	 CB 30 FUNCTION \$418.00		 CB 26 FUNCTION \$478.00	 CB 34 FUNCTION \$738.00	 CB 24 FUNCTION \$758.00	 CB 40 FUNCTION \$209.00

CURVED SUITE / PASSAGE & PRIVACY SETS

Note: Ashley Norton supplies Accurate 9800 series interior locks with our mortise passage and privacy sets. Should you prefer a 3 hour UL rated, full size lock for design or code requirements, please contact us for pricing.

Note: For full dummy, order 1x LH and 1x RH single dummies

ANGULAR SUITE — MORTISE ENTRYSETS

MORTISE ENTRYSET ORDERING GUIDE

Patina	Escutcheon	Lever/Knob	Function	Handing	Backset
BZ Dark Bronze	select from	select from	select from	L LHR	2 1/2"
WL White Bronze TC Matt Black	table below	pages 11-17	table across	R RHR	2 3/4"
WM White Medium NB Natural Bronze					

For example to order an item in White Bronze (WL) patina, with the 24" x 3 1/2" grip entry escutcheon (AGLGL), the Apollo (450) lever in an Entry (10) function for a right hand door (R), use product code: WL.AGLGL.450.10.R and specify backset

- Available with any lever or knob
- ANSI F12 Entry is supplied with Accurate 9148B lock; ANSI F13 Dormitory is supplied with Accurate 9124B lock. See page 8 for further details. Other locks available on request (upcharge may apply)
- For narrow or extended backsets, please email quote request including quantities to custom@ashleynorton.com
- Specify door thickness and handing including door swing (e.g. Left, Right, Left Reverse, Right Reverse)
- For doors 2 1/2" or thicker, a \$120 list upcharge will apply
- Maximum door thickness is 3"

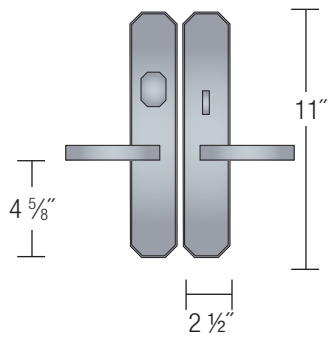

AGMOR

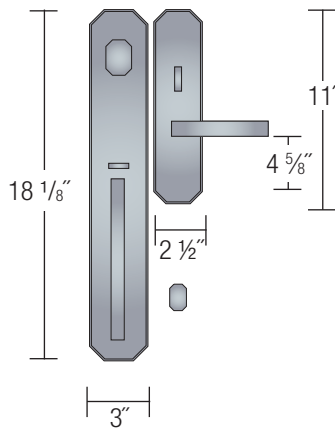

AGSGL

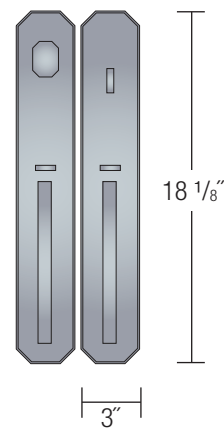



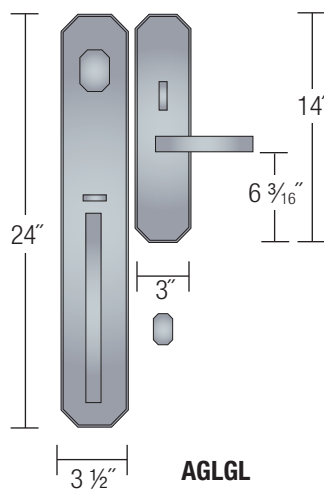



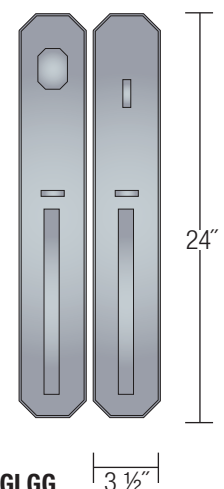

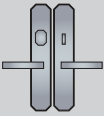
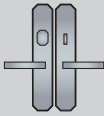
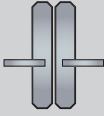
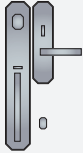

AGSGG

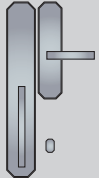

AGLGL



AGLGG

	MORTISE ENTRY ⁽¹⁾ ANSI F12	MORTISE DORMITORY ⁽¹⁾ ANSI F13	FULL DUMMY
LEVER x LEVER OR KNOB x KNOB 11 x 2 ½"	 AGMOR / 12 FUNCTION	 AGMOR / 13 FUNCTION	 AGMOR / 22 FUNCTION
Price	\$1,110.00	\$1,110.00	\$610.00
GRIP x LEVER OR GRIP x KNOB EXTERIOR: 18 ⅛ x 3" INTERIOR: 11 x 2 ½"	 AGSGL / 10 FUNCTION	 AGSGL / 11 FUNCTION	 AGSGL / 42 FUNCTION
Price	\$1,398.00	\$1,398.00	\$898.00
GRIP x LEVER OR GRIP x KNOB EXTERIOR: 24 x 3 ½" INTERIOR: 14 x 3"	 AGLGL / 10 FUNCTION	 AGLGL / 11 FUNCTION	 AGLGL / 42 FUNCTION
Price	\$1,612.00	\$1,612.00	\$1,112.00
GRIP x GRIP 18 ⅛ x 3"	 AGSGG / 14 FUNCTION	 AGSGG / 15 FUNCTION	 AGSGG / 42 FUNCTION
Price	\$1,824.00	\$1,824.00	\$1,264.00
GRIP x GRIP 24 x 3 ½"	 AGLGG / 14 FUNCTION	 AGLGG / 15 FUNCTION	 AGLGG / 42 FUNCTION
Price	\$2,176.00	\$2,176.00	\$1,616.00

(1) See page 8 for explanation of these locks.

ANGULAR SUITE — TUBULAR ENTRYSETS & DEADBOLTS

TUBULAR ENTRYSET ORDERING GUIDE

Patina	Escutcheon	Lever/Knob	Function	Handing	Backset
BZ Dark Bronze	select from	select from	select from	L Left	2 ³ / ₈ "
WL White Bronze	TC Matt Black	pages 11-17	table across	R Right	2 ³ / ₄ "
WM White Medium	NB Natural Bronze				

For example to order an item in White Bronze (WL) patina, with the 11" x 2 1/2" lever x lever escutcheon (AGLES), the Greenwich (350) lever in an Patio (43) function for a right hand door (R), use product code: WL.AGLES.350.43.R and specify backset

- Available with any lever or knob
- Suitable for doors with standard 5 1/2" center to center
- Supplied with tubular latch and deadbolt
- Specify door thickness, handing and backset (2 3/8" or 2 3/4")
- Maximum door thickness for AGTUB (grip x lever/knob entryset): 2 1/2"
- Maximum door thickness for AGLES entryset and deadbolts: 3" for single keyed or patio, 2 1/4" for double-keyed

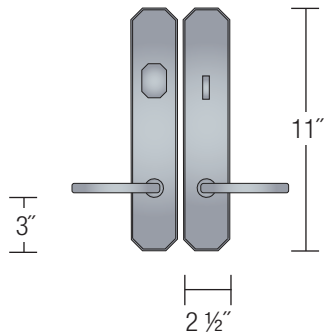

AGLES

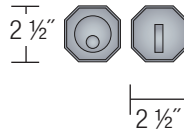

4115

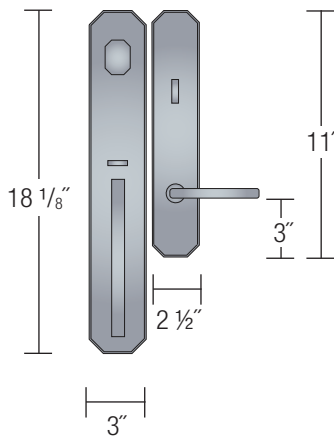

AGTUB

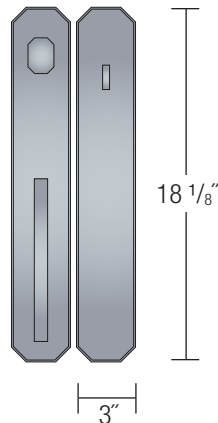

AG.GE.18

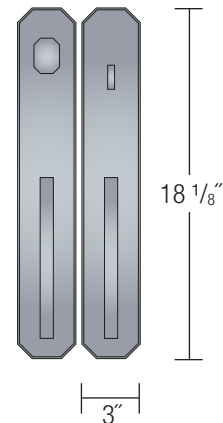









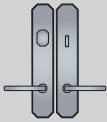
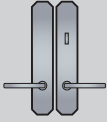
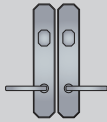
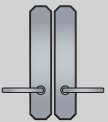
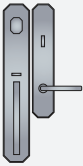
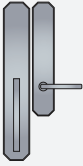

AG.GG.18

- Maximum door thickness 2 1/2"

Pull/Push and Pull/Pull sets features tubular deadbolt, but no tubular latch
If latching is required, consider the AGTUB grip x lever/knob entryset

ANGULAR SUITE — TUBULAR ENTRYSETS & DEADBOLTS

	KEYED ENTRY	PATIO	DOUBLE ENTRY	FULL DUMMY
LEVER x LEVER OR KNOB x KNOB 11 x 2 1/2"	 AGLES / 50 FUNCTION	 AGLES / 43 FUNCTION	 AGLES / 52 FUNCTION	 AGLES / 42 FUNCTION
Price	\$688.00	\$688.00	\$744.00	\$610.00
GRIP x LEVER OR GRIP x KNOB EXTERIOR: 18 1/8 x 3" INTERIOR: 11 x 2 1/2"	 AGTUB / 50 FUNCTION			 AGTUB / 42 FUNCTION
Price	\$986.00			\$898.00
	DEADBOLT	PATIO DEADBOLT	DOUBLE KEYED DEADBOLT	FULL DUMMY
DEADBOLT 2 1/2" x 2 1/2"	 4115	 4715	 4215	
Price	\$200.00	\$182.00	\$246.00	
PULL x PUSH DEADBOLT⁽¹⁾ 18 1/8 x 3"	 AG.GE.18.50		 AG.GE.18.52	 AG.GE.18.42
Price	\$1,147.00		\$1,203.00	\$979.00
PULL x PULL DEADBOLT⁽¹⁾ 18 1/8 x 3"	 AG.GG.18.50		 AG.GG.18.52	 AG.GG.18.42
Price	\$1,486.00		\$1,542.00	\$1,318.00

ANGULAR SUITE / TUBULAR ENTRYSETS & DEADBOLTS

(1) Pull x Push and Pull x Pull sets feature a keyed tubular deadbolt, but not a tubular latch. If latching is required, consider a grip x lever/knob entryset.

ANGULAR SUITE — PASSAGE & PRIVACY

PASSAGE & PRIVACY ORDERING GUIDE

Please insert your specific selections into the template to create the product you require.

Patina	Escutcheon	Lever/Knob	Function	Handing	Backset
BZ Dark Bronze	select from	select from	select from	L	2 ³ / ₈ "
WL White Bronze TC Matt Black	table below	pages 11-17	table across	R	2 ³ / ₄ "
WM White Medium NB Natural Bronze					

For example to order an item in Dark Bronze (BZ) patina, with the 7 1/2" x 2 1/2" escutcheon (AL), the Centaur (349) lever in a Single Dummy (40) function for a left hand door (L), use product code: BZ.AL.349.40.L

- Available with any lever or knob
- Handing not required for tubular passage and privacy sets
- Specify door thickness and backset (2 3/8" or 2 3/4" for tubular latch; 2 1/2" or 2 3/4" for interior mortise locks)
- Maximum door thickness: 3" (passage); 2 1/2" (privacy)

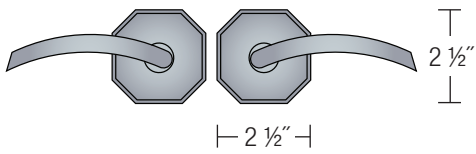

AS

- Not suitable for use with Windsor (900) or Newport (990) knobs

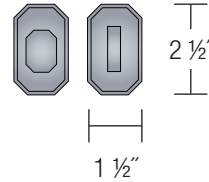

AG587

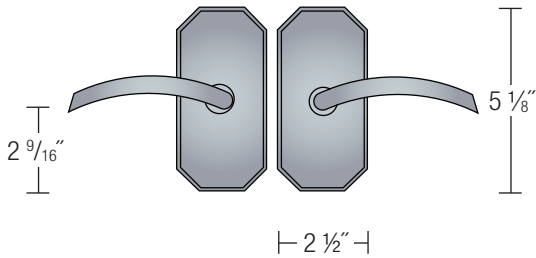

AG

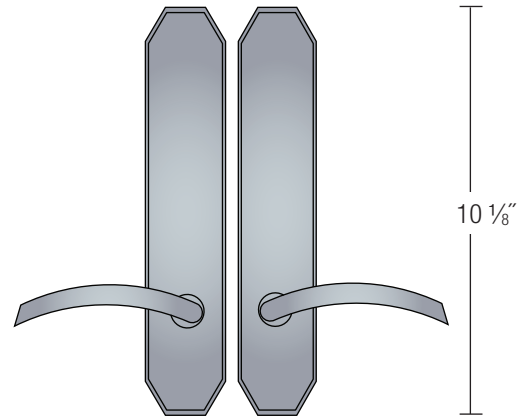





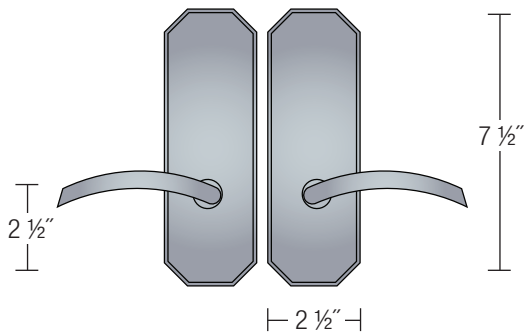





AB

Will not cover 2 1/8" bore

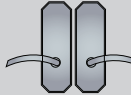
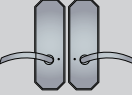
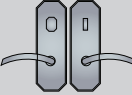
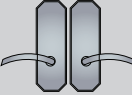
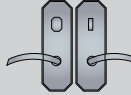

AL

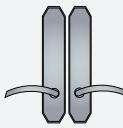
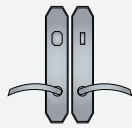
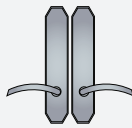
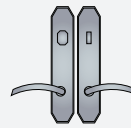
ANGULAR SUITE — PASSAGE & PRIVACY

	TUBULAR PASSAGE	TUBULAR PRIVACY (PIN)	TUBULAR PRIVACY (BOLT)	MORTISE PASSAGE	MORTISE PRIVACY	SINGLE DUMMY
LEVER x LEVER OR KNOB x KNOB 2 ½ x 2 ½" Price	 AS 30 FUNCTION \$268.00	 AS 20 FUNCTION \$283.00	 AG587 PRIVACY BOLT \$136.00			 AS 40 FUNCTION \$134.00
LEVER x LEVER OR KNOB x KNOB 5 ⅞ x 2 ½" Price	 AG 30 FUNCTION \$300.00	 AG 20 FUNCTION \$315.00				 AG 40 FUNCTION \$150.00
LEVER x LEVER OR KNOB x KNOB 7 ½ x 2 ½" Price	 AL 30 FUNCTION \$358.00	 AL 20 FUNCTION \$373.00	 AL 26 FUNCTION \$418.00	 AL 34 FUNCTION \$678.00	 AL 24 FUNCTION \$698.00	 AL 40 FUNCTION \$179.00
LEVER x LEVER OR KNOB x KNOB 10 ⅞ x 1 ¾" Will not cover 2 ⅞" bore Price	 AB 30 FUNCTION \$418.00		 AB 26 FUNCTION \$478.00	 AB 34 FUNCTION \$738.00	 AB 24 FUNCTION \$758.00	 AB 40 FUNCTION \$209.00

ANGULAR SUITE / PASSAGE & PRIVACY SETS

Note: Ashley Norton supplies Accurate 9800 series interior locks with our mortise passage and privacy sets. Should you prefer a 3 hour UL rated, full size lock for design or code requirements, please contact us for pricing.

Note: For full dummy, order 1x LH and 1x RH single dummies

TRADITIONAL SUITE — PASSAGE/PRIVACY & DEADBOLTS

PASSAGE & PRIVACY ORDERING GUIDE

Patina	Escutcheon	Lever/Knob	Function	Handing	Backset
BZ Dark Bronze	select from	select from	select from	L	2 3/8"
WL White Bronze	table below	pages 11-17	table across	R	2 3/4"
WM White Medium					
TC Matt Black					
NB Natural Bronze					

For example to order an item in Dark Bronze (BZ) patina, with the 5 1/8" x 2 1/2" escutcheon (OV), the Churchill (500) lever in a passage (30) function for a left hand door (L), use product code: BZ.OV.500.30.L and specify backset

- Handing not required for passage and privacy sets
- Specify door thickness and backset (2 3/8" or 2 3/4")
- Maximum door thickness: 3" (passage); 2 1/2" (privacy)

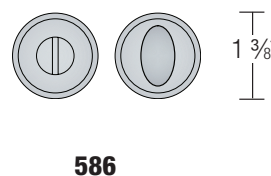
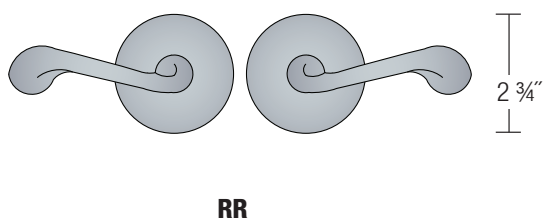
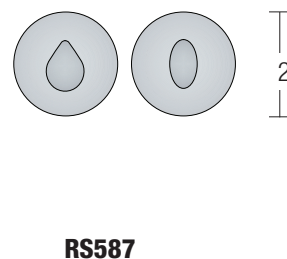
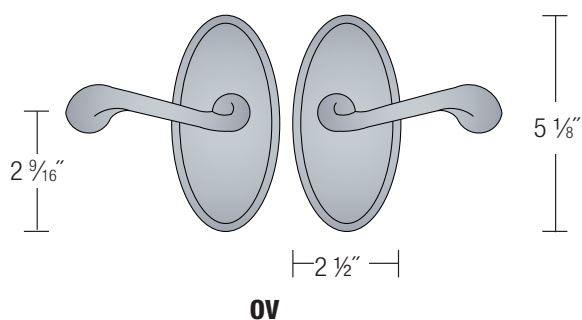

With emergency screw release

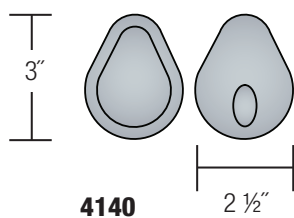



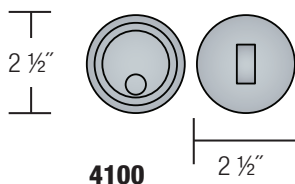



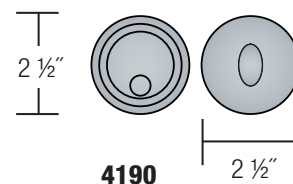



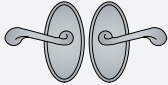
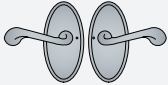

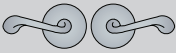
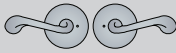

Interior side with egg thumbturn



Interior side with flat thumbturn



Interior side with egg thumbturn

	TUBULAR PASSAGE	TUBULAR PRIVACY (PIN)	PRIVACY (BOLT)	DUMMY
LEVER x LEVER OR KNOB x KNOB 5 1/8 x 2 1/2" PLATES Price	 OV 30 FUNCTION \$300.00	 OV 20 FUNCTION \$315.00		 OV 40 FUNCTION \$150.00
LEVER x LEVER OR KNOB x KNOB 2 3/4" DIA. PLATES Price	 RR 30 FUNCTION \$268.00	 RR 20 FUNCTION \$283.00	 586 PRIVACY BOLT \$120.00	 RR 40 FUNCTION \$134.00
			 R5587 PRIVACY BOLT \$120.00	 RR 42 FUNCTION \$268.00
	DEADBOLT	PATIO DEADBOLT	DOUBLE KEYED DEADBOLT	FULL DUMMY
DEADBOLT (egg thumbturn) 3 x 2 1/2" Price	 4140 \$262.00	 4740 \$244.00	 4240 \$308.00	
DEADBOLT (flat thumbturn) 2 1/2" Dia Price	 4100 \$188.00 Collar available for 1 3/8" doors and Level Bolt	 4700 \$170.00	 4200 \$234.00	
DEADBOLT (egg thumbturn) 2 1/2" Dia Price	 4190 \$188.00 Collar available for 1 3/8" doors and Level Bolt	 4790 \$170.00		

TRADITIONAL SUITE / PASSAGE & PRIVACY SETS

TRADITIONAL SUITE / DEADBOLTS

Note: For full dummy with OV plate, order 1x LH and 1x RH single dummies
 Order 4100-COLLAR if 4100 or 4190 deadbolts are to be installed on 1 3/8" door, or with Level Bolt on 1 3/4" door. Price \$46.00

MULTIPOINT HANDLESETS

Ashley Norton offers multipoint handlesets to suit most door and lock manufacturers.

To determine the correct multipoint handleset configuration, a few pieces of information are required:

- The manufacturer of the french door or multipoint lock
- The distance between the lever and the cylinder - typically 92mm or 105mm
- The type of cylinder - American, Europrofile or Andersen
- Whether the levers are above or below the cylinder

Listed below are some of the most common door and lock manufacturers. Our customer service team is available to assist in identifying the correct configuration for specific locks - email lock drawings to service@ashleynorton.com to get started.

Ashley Norton provides handlesets, spindle, screws and cylinder (where needed). We do not include the multipoint lock, strike or faceplate.

All of our handlesets have a two-way spring assist to avoid lever-sag.

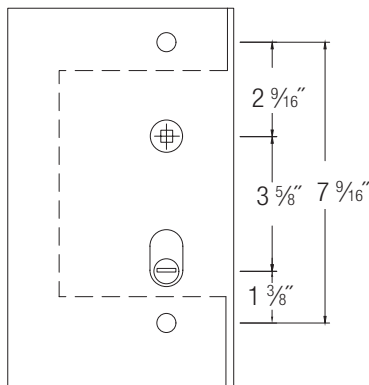

CONFIGURATION 1 - LEVER HIGH / AMERICAN CYLINDER

Lever-high American cylinder locks with 92mm CTC
e.g. G-U locks, Lepage Millwork

Not suitable for Marvin Integrity doors

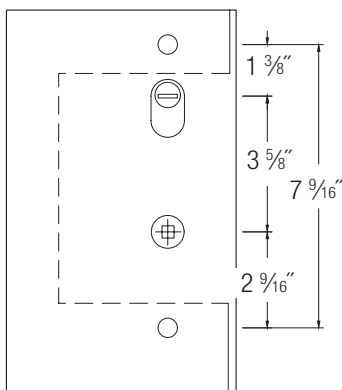

CONFIGURATION 2 - LEVER LOW / AMERICAN CYLINDER

Lever-low American cylinder locks with 92mm CTC

e.g. G-U locks, Sierra Pacific Wisconsin Product (formerly Hurd), Biltbest

MULTIPOINT HANDLESETS

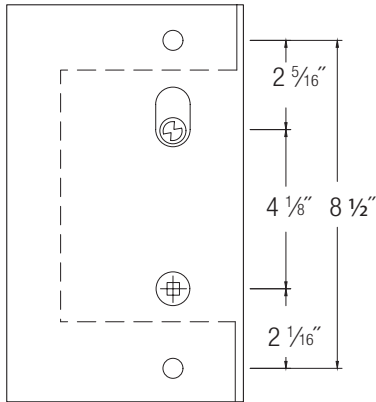

CONFIGURATION 3 - ANDERSEN LOCKS

Lever-low Andersen locks with 105mm CTC

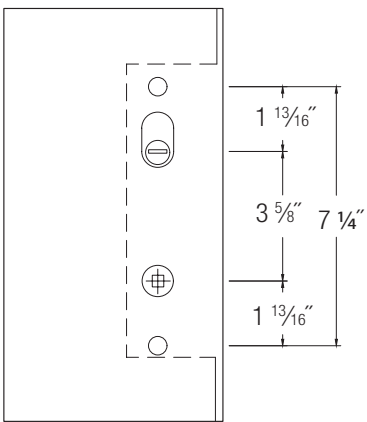

CONFIGURATION 4 - ASHLAND LOCKS

Lever-low Ashland locks with 92mm CTC

e.g. Caradco, JELD-WEN⁽¹⁾, Marvin⁽²⁾, PGT and Weather Shield⁽¹⁾

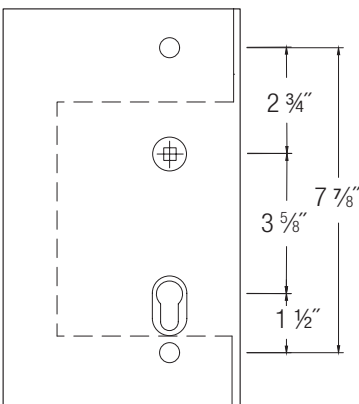

CONFIGURATION 5 - EUROPROFILE CYLINDER

Lever-high Europrofile cylinder locks with 92mm CTC

e.g. Hoppe locks, JELD-WEN⁽¹⁾, Kolbe, KFV, Lincoln, Loewen, Norco, Peachtree, Semco, Weather Shield⁽¹⁾, Sierra Pacific⁽³⁾, Windsor and Vetter

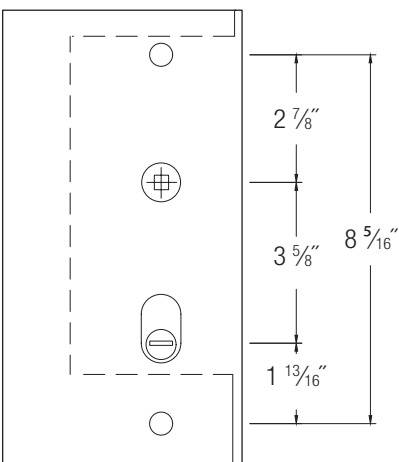

CONFIGURATION 6 - LEVER HIGH / AMERICAN CYLINDER

Lever-high American cylinder locks with 92mm CTC

e.g. G-U locks, Milgard, Pella

(1) JELD-WEN and Weather Shield may use either Hoppe or Ashland locks.

(2) For true Marvin doors only, not suitable for Integrity.

(3) Sierra Pacific Wisconsin Product (formerly Hurd) uses G-U locks, see Configuration 2

MULTIPOINT CONFIGURATION 1 - AMERICAN CYLINDER BELOW LEVER

Patina	Escutcheon	Lever	Function	Handing	
BZ Dark Bronze	select from table below	select from pages 11-15	select from table below	L	
WL White Bronze				TC Matt Black	R
WM White Medium				NB Natural Bronze	

- Suitable for lever-high G-U locks and similar with 92mm CTC operated using an American cylinder
- 7 9/16" screw to screw
- Doors require Patio (53) function on secondary panel of double doors where active multipoint hardware is present
- For 13" x 2 1/2" wide plate, change last digit of escutcheon to 5 (e.g. change SQLP4 to SQLP5). \$165 list upcharge applies
- Door manufacturers listed for reference only and subject to change. Multipoint lock, strike and faceplate not included

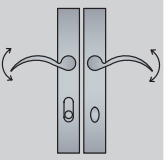
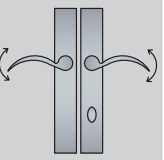
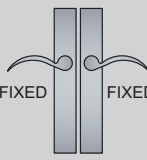
REFERENCE	ENTRY	PATIO	DUMMY
US TAILPIECE LEVER HIGH G-U LOCKS 92mm CTC Price	 55 FUNCTION \$476.00	 53 FUNCTION \$476.00	 42 FUNCTION \$476.00

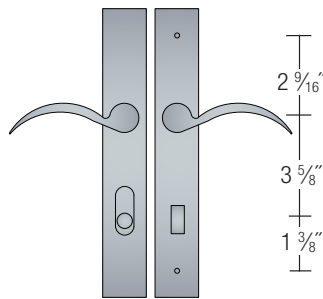

MDLP4
10 1/8" x 1 3/4"

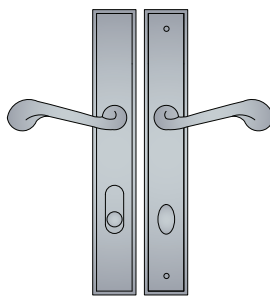

SQLP4
10 1/8" x 1 3/4"

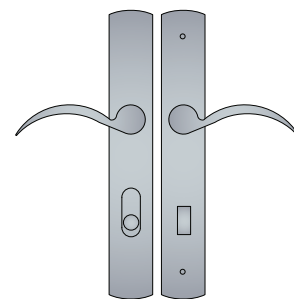

CVLP4
10 1/8" x 1 3/4"

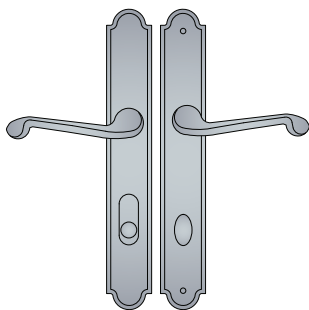

SPLP4
11 1/4" x 1 3/4"

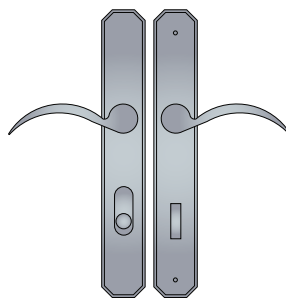

AGLP4
10 1/8" x 1 3/4"

MULTIPOINT CONFIGURATION 2 - AMERICAN CYLINDER ABOVE LEVER

Patina	Escutcheon	Lever	Function	Handing
BZ Dark Bronze	select from table below	select from pages 11-15	select from table below	L
WL White Bronze TC Matt Black				R
WM White Medium NB Natural Bronze				

- Suitable for lever-low G-U locks with 92mm CTC and similar operated using an American cylinder
- 7 1/16" screw to screw
- Doors require Patio (53) function on secondary panel of double doors where active multipoint hardware is present
- For 13" x 2 1/2" wide plate, change last digit of escutcheon to 5 (e.g. change SQEG4 to SQEG5). \$165 list upcharge applies
- Door manufacturers listed for reference only and subject to change. Multipoint lock, strike and faceplate not included

	REFERENCE	ENTRY	PATIO	DUMMY
US TAILPIECE LEVER LOW				
G-U LOCKS	SIERRA PACIFIC WISCONSIN PRODUCT (FORMERLY HURD), BILTBEST			
92mm CTC		55 FUNCTION	53 FUNCTION	47 FUNCTION
Price		\$476.00	\$476.00	\$476.00

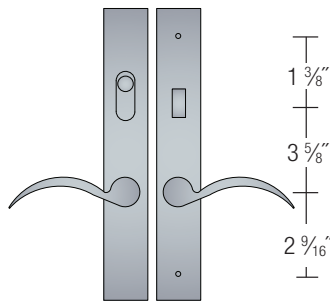

MDEG4
10 1/8" x 1 3/4"

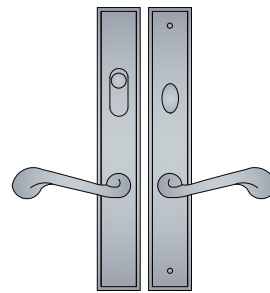

SQEG4
10 1/8" x 1 3/4"

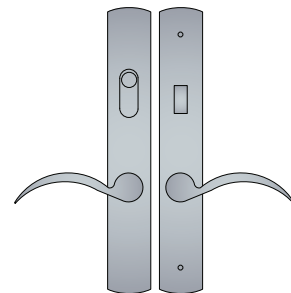

CVEG4
10 1/8" x 1 3/4"

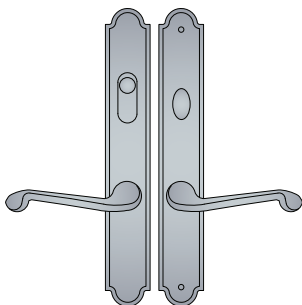

SPEG4
11 1/4" x 1 3/4"

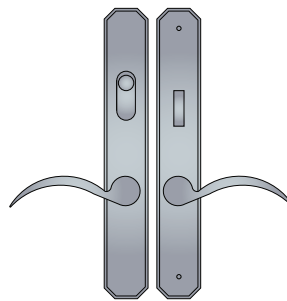

AGEG4
10 1/8" x 1 3/4"

MULTIPOINT CONFIGURATION 3 - ANDERSEN LOCKS

Patina	Escutcheon	Lever	Function	Handing	
BZ Dark Bronze	select from table below	select from pages 11-15	select from table below	L	
WL White Bronze				TC Matt Black	R
WM White Medium				NB Natural Bronze	

- Suitable for Andersen locks with 105mm CTC
- 8 ½" screw to screw
- Andersen's double doors require a Passive (39) function on the secondary panel of double doors
- Multipoint lock, strike and faceplate not included

	REFERENCE	ENTRY	PATIO	PASSIVE
US TAILPIECE LEVER HIGH				
ANDERSEN LOCKS	ANDERSEN	55 FUNCTION	53 FUNCTION	39 FUNCTION
105mm CTC				
Price		\$476.00	\$476.00	\$476.00

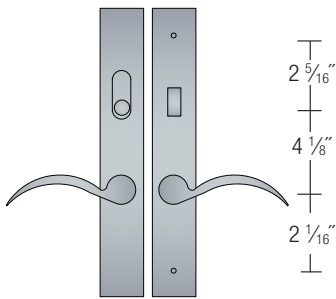

MDAD4
10 1/8" x 1 3/4"

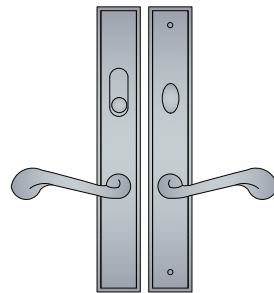

SQAD4
10 1/8" x 1 3/4"

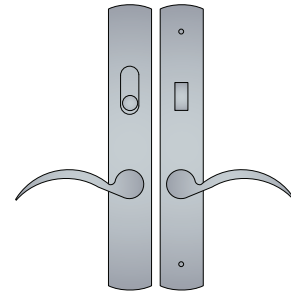

CVAD4
10 1/8" x 1 3/4"

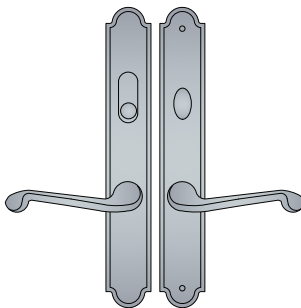

SPAD4
11 1/4" x 1 3/4"

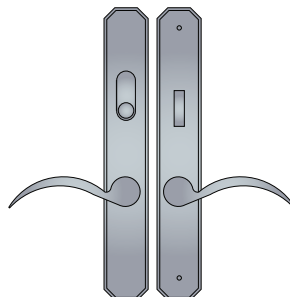

AGAD4
10 1/8" x 1 3/4"

MULTIPOINT CONFIGURATION 4 - ASHLAND LOCKS

Patina	Escutcheon	Lever	Function	Handing
BZ Dark Bronze	select from table below	select from pages 11-15	select from table below	L
WL White Bronze TC Matt Black				R
WM White Medium NB Natural Bronze				

- Suitable for Ashland locks with 92mm CTC
- 7 1/4" screw to screw
- Marvin and Weather Shield doors require Passive (39) function on the secondary panel of double doors where active multipoint hardware is present
- For 13" x 2 1/2" wide plate, change last digit of escutcheon to 5 (e.g. change SQMR4 to SQMR5). \$165 list upcharge applies
- Door manufacturers listed for reference only and subject to change. Multipoint lock, strike and faceplate not included

	REFERENCE	ENTRY	PATIO	DUMMY	PASSIVE
US TAILPIECE LEVER LOW	CARADCO, JELD-WEN ⁽¹⁾ , MARVIN ⁽²⁾ , PGT, WEATHER SHIELD ⁽¹⁾				
ASHLAND LOCKS		55 FUNCTION	53 FUNCTION	47 FUNCTION	39 FUNCTION
92mm CTC					
Price		\$476.00	\$476.00	\$476.00	\$476.00

(1) JELD-WEN and Weather Shield doors may use either Hoppe or Ashland locks depending on product range and manufacture date

(2) For true Marvin doors only, not suitable for Integrity

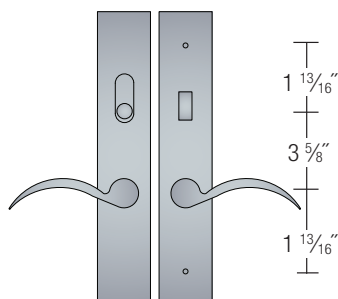

MDMR4
10 1/8" x 1 7/8"

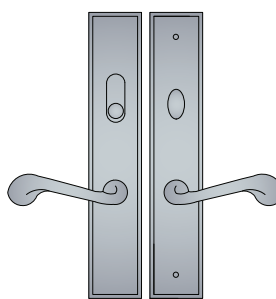

SQMR4
10 1/8" x 1 7/8"

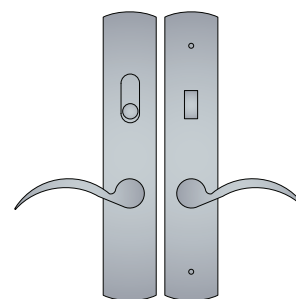

CVMR4
10 1/8" x 1 7/8"

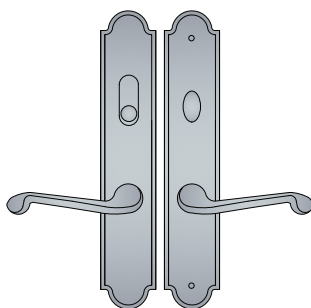

SPMR4
11 1/4" x 1 7/8"

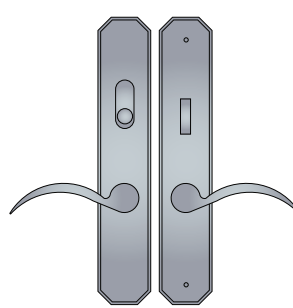

AGMR4
10 1/8" x 1 7/8"

MULTIPOINT CONFIGURATION 5 - PROFILE CYLINDER BELOW LEVER

Patina	Escutcheon	Lever	Function	Handing
BZ Dark Bronze	select from table below	select from pages 11-15	select from table below	L
WL White Bronze TC Matt Black				R
WM White Medium NB Natural Bronze				

- Suitable for Hoppe locks or similar with 92mm CTC using a profile cylinder. Screw to screw is 7 7/8"
- Contact us before ordering split finish keyed entry function with profile cylinder as upcharge will apply
- We assume lock is centered within door. Offset profile cylinders available for certain 2 1/4" doors, contact us for details and pricing
- Doors require Patio (58) function on secondary panel of double doors where active multipoint hardware is present
- For 13" x 2 1/2" wide plate, change last digit of escutcheon to 5 (e.g. change SQUEU4 to SQUEU5). \$165 list upcharge applies
- Door manufacturers listed for reference only and subject to change. Multipoint lock, strike and faceplate not included

	REFERENCE	ENTRY	PATIO	DUMMY
PROFILE CYLINDER LEVER HIGH	JELD-WEN ⁽¹⁾ , KOLBE & KOLBE, KJV, LINCOLN, LOEWEN, NORCO, PEACHTREE, SEMCO, WEATHER SHIELD ⁽¹⁾ , SIERRA PACIFIC ⁽²⁾ , WINDSOR, VETTER			
HOPPE LOCKS		57 FUNCTION	58 FUNCTION	42 FUNCTION
92mm CTC				
Price		\$476.00	\$476.00	\$476.00

(1) JELD-WEN and Weather Shield doors may use either Hoppe or Ashland locks depending on product range and manufacture date

(2) Sierra Pacific Wisconsin Product (formerly Hurd) uses G-U locks, see Configuration 2

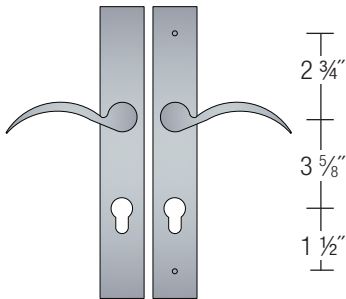

MDEU4
10 1/8" x 1 3/4"

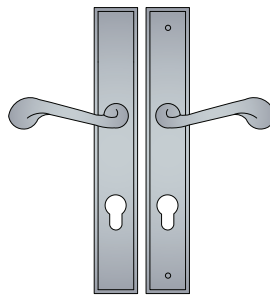

SQUEU4
10 1/8" x 1 3/4"

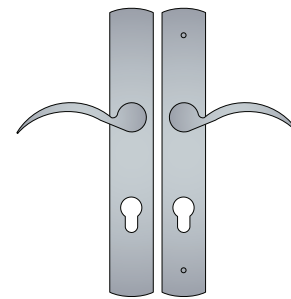

CVEU4
10 1/8" x 1 3/4"

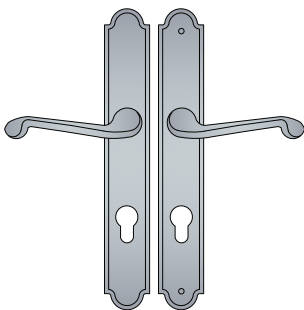

SPEU4
11 1/4" x 1 3/4"

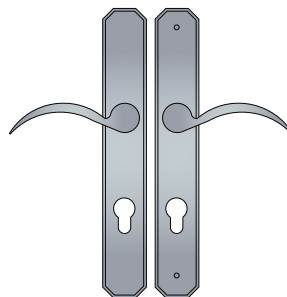

AGEU4
10 1/8" x 1 3/4"

MULTIPOINT CONFIGURATION 6 - AMERICAN CYLINDER BELOW LEVER

Patina	Escutcheon	Lever	Function	Handing	
BZ Dark Bronze	select from table below	select from pages 11-15	select from table below	L	
WL White Bronze				TC Matt Black	R
WM White Medium				NB Natural Bronze	

- Suitable for lever-high G-U locks with 92mm CTC and similar operated using an American cylinder
- 8 5/16" screw to screw
- Most doors require Patio (53) function on secondary panel of double doors where active multipoint hardware is present
- For 13" x 2 1/2" wide plate, change last digit of escutcheon to 5 (e.g. change SQUS4 to SQUS5). \$165 list upcharge applies
- Door manufacturers listed for reference only and subject to change. Multipoint lock, strike and faceplate not included

	REFERENCE	ENTRY	PATIO	DUMMY
US TAILPIECE LEVER HIGH	MILGARD, PELLA			
G-U LOCKS		55 FUNCTION	53 FUNCTION	42 FUNCTION
92mm CTC				
Price		\$476.00	\$476.00	\$476.00

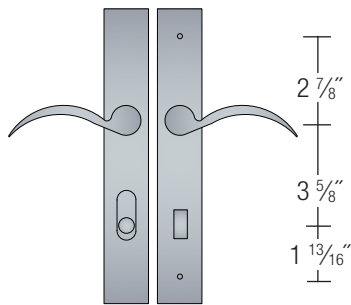

MDUS4
10 1/8" x 1 3/4"

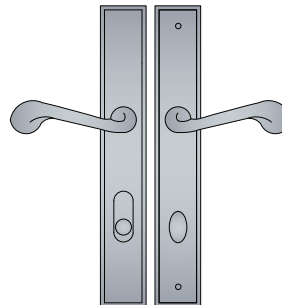

SQUS4
10 1/8" x 1 3/4"

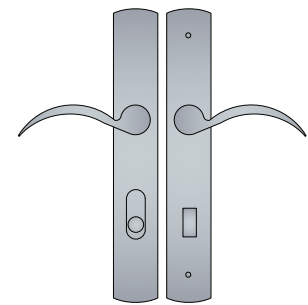

CVUS4
10 1/8" x 1 3/4"

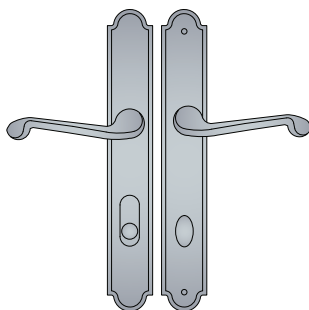

SPUS4
11 1/4" x 1 3/4"

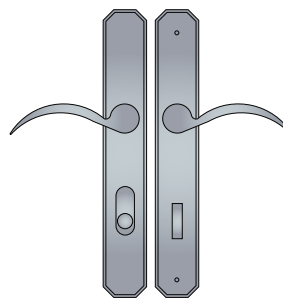

AGUS4
10 1/8" x 1 3/4"

TRIM FOR SLIDING FRENCH & PATIO DOORS



SLDPULL-OS
(Offset tailpiece)



SLDPULL-CT
(Centered tailpiece)

Single Point Sliding Handle

8 3/8" x 1"

- Suitable for locks with mounting holes 100mm (3.94") apart.
- Narrow (1") plate makes this ideal for doors with narrow stile.
- Handing not required.

FUNCTION	RECTANGULAR	PRICE
Patio with offset tailpiece	SLDPULL-OS.43	\$348.00
Patio with centered tailpiece	SLDPULL-CT.43	\$348.00
Dummy	SLDPULL.42	\$348.00

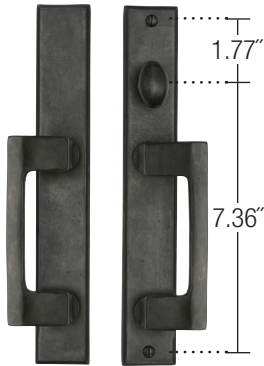

SQHPS

10 1/8" x 1 1/2"

Shown with 454 Offset Apollo handle
in dark bronze patina

Handle for Hoppe HLS 9000 Lock

- Suitable only for Hoppe HLS 9000 sliding door lock.
- Thumbturn operates a 7mm spindle (square orientation).
- Available with Offset Apollo (454) handle as shown on left.

SUITE	HANDLE	FUNCTION	PRICE
SQHPS Rectangular	10 1/8" x 1 1/2"	43 Patio	\$570.00
MDHPS Urban	10 1/8" x 1 1/2"	42 Dummy	\$570.00

TRIM FOR SLIDING FRENCH & PATIO DOORS

TSL CONFIGURATION

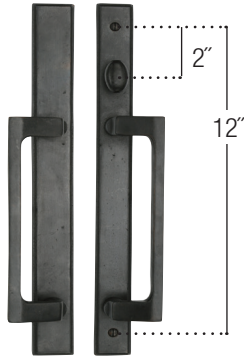

13 3/4" x 1 1/4" Plate
Shown with Dunn Pull

MWF CONFIGURATION

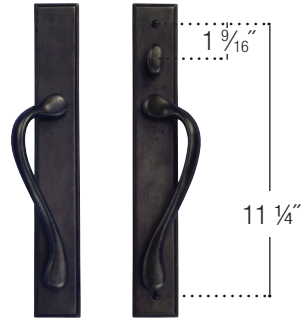

13 x 1 7/8" Plate
Shown with York Pull

Ordering Guide for Sliding Door Hardware

- The above handlesets are configured to operate a lock with an American tailpiece. If the lock has a 7mm spindle, see handlesets for HLS 9000 lock on previous page.
- Match distance from top screw to thumbturn, and between top and bottom screws with one of the above plate configurations.
- Choose pull handle design - either the Dunn handle or the York handle can be combined with any plate configuration.
- Handing is not required. The pull handles are attached to plate with two screws and can easily be swapped in field.
- Use table below to construct a part number. Contact us for assistance if needed.

SUITE	CONFIGURATION	PULL	FUNCTION	PRICE
SQ Rectangular or MD Urban	TSL or MWF	York or Dunn	43 Patio 42 Dummy	\$570.00 \$570.00

EDGE & FLUSH PULLS

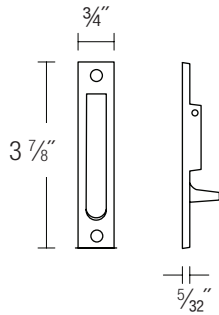

1165 Edge pull

Price:\$42.20

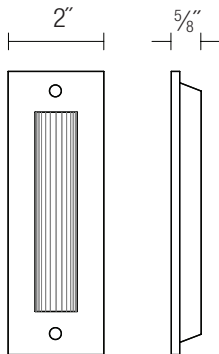

1820 Flush Pull

ITEM	LENGTH	PRICE
1820.4	4"	\$44.10
1820.6	6"	\$58.40
1820.8	8"	\$71.10
1820.12	12"	\$127.30



1821.2 Round Flush Pull

ITEM	OUTER DIA	INNER DIA	PRICE
1821.2	2 1/2"	2 1/8"	\$63.10



1823 Flush pull

7" x 2 1/4"

Price:\$135.90

SLIDING & POCKET DOOR HARDWARE



Sliding/Pocket Door Hardware

8 1/2" x 2 1/2"

- Supplied with mortise lock
- Available 2 1/2" or 2 3/4" backset
- Minimum door thickness: 1 3/4"
- Maximum door thickness: 2 1/4"
- Keyed version cannot be flush mounted

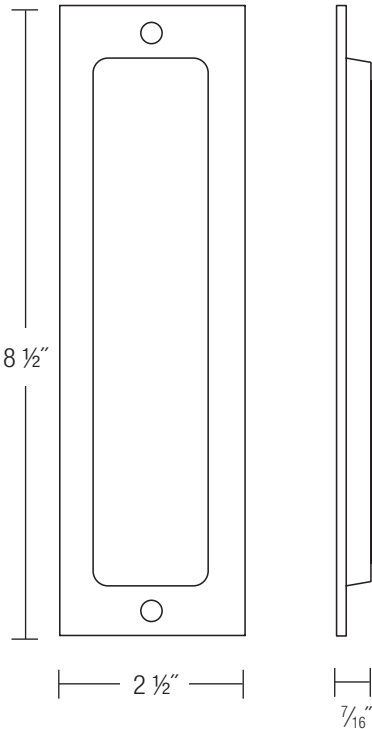

	<p>1830.8.25</p> <ul style="list-style-type: none"> • PRIVACY FUNCTION • INCLUDES MORTISE LOCK / PULL • MINIMUM DOOR THICKNESS 1 3/4" 	<p>Price: \$595.00</p>
	<p>1830.8.25 DBL</p> <ul style="list-style-type: none"> • PRIVACY FUNCTION FOR DOUBLE DOORS • INCLUDES MORTISE LOCK / PULL AND MORTISE STRIKE / PULL • MINIMUM DOOR THICKNESS 1 3/4" 	<p>Price: \$1,178.00</p>
	<p>1830.8.44</p> <ul style="list-style-type: none"> • PATIO FUNCTION • INCLUDES MORTISE LOCK / PULL • MINIMUM DOOR THICKNESS 1 3/4" 	<p>Price: \$595.00</p>
	<p>1830.8.44 DBL</p> <ul style="list-style-type: none"> • PATIO FUNCTION FOR DOUBLE DOORS • INCLUDES MORTISE LOCK / PULL AND MORTISE STRIKE / PULL • MINIMUM DOOR THICKNESS 1 3/4" 	<p>Price: \$1,178.00</p>
	<p>1830.8.50</p> <ul style="list-style-type: none"> • ENTRY FUNCTION • INCLUDES MORTISE LOCK / PULL • MINIMUM DOOR THICKNESS 1 3/4" • KEYED SET CANNOT BE FLUSH MOUNTED 	<p>Price: \$680.00</p>
	<p>1830.8.50 DBL</p> <ul style="list-style-type: none"> • ENTRY FUNCTION FOR DOUBLE DOORS • INCLUDES MORTISE LOCK / PULL AND MORTISE STRIKE / PULL • MINIMUM DOOR THICKNESS 1 3/4" • KEYED SET CANNOT BE FLUSH MOUNTED 	<p>Price: \$1,263.00</p>
	<p>1830.8.34</p> <ul style="list-style-type: none"> • PASSAGE FUNCTION • INCLUDES MORTISE PULL • MINIMUM DOOR THICKNESS 1 3/4" 	<p>Price: \$476.00</p>
	<p>1830.8.40</p> <ul style="list-style-type: none"> • FLUSH PULL • SINGLE PULL SUPPLIED • NO LOCK 	<p>Price: \$96.00</p>

POCKET DOOR HARDWARE

GATE HARDWARE

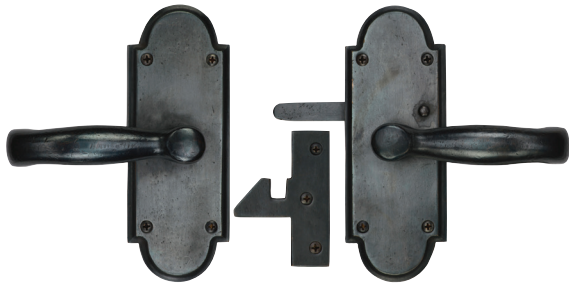

Gate Latch

Shown with Hampton 400 lever on SR backplate

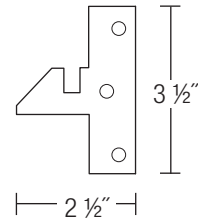

ORDERING GUIDE

Patina	Escutcheon	Lever	Function	Handing
BZ Dark Bronze	select from table below	select from pages 11-15	36 Gate Passage	L LHR
WL White Bronze TC Matt Black				R RHR
WM White Medium NB Natural Bronze				

Handing including swing direction is critical when ordering gate hardware.

Drop bar is not designed to act as the sole closing device for a gate. This product is designed to be used with a gate stop or other hardware that stops the gate slightly before the drop bar connects with the strike. Should you require a gate stop, please see below.

Gate Hardware is available for doors between 1 3/8" to 3" thick in your choice of these escutcheons with any lever. Knobs not suitable for use with gate hardware.

PLATE	LEVER	PRICE
SQ	Select any Ashley Norton Lever	\$356.00
SR		
CV		
MD		
AG		



SQ

Rectangular
5 1/8" x 2 1/2"

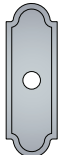

SR

Arched
7" x 2 1/2"



CV

Curved
5 1/8" x 2 1/2"



MD

Urban
5 1/8" x 2 1/2"



AG

Angular
5 1/8" x 2 1/2"

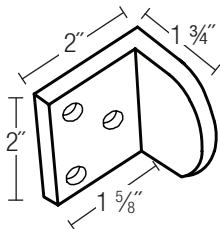

3550.1 3/4 Standard Gate Stop

Price: \$66.00

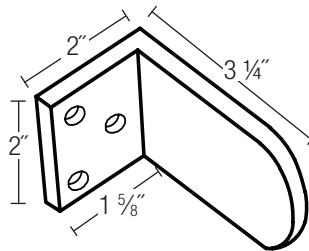

3550.3 1/4 Extended Gate Stop

Price: \$103.00

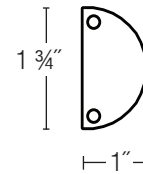

Strike included with Gate stops

GATE HARDWARE



3540 Hasp and Staple

Price: \$79.00

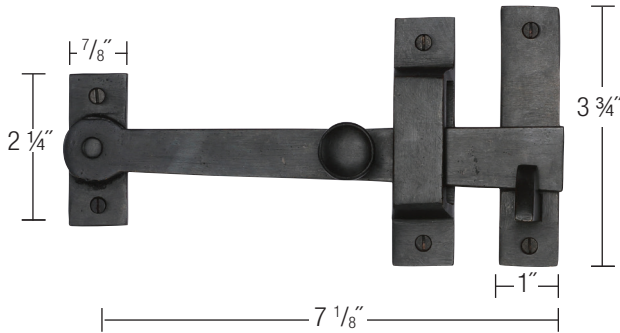

3520 Drop Bar with Handle

Price: \$136.00

Hardware installed on single side of door
Must be used in conjunction with a gate stop.

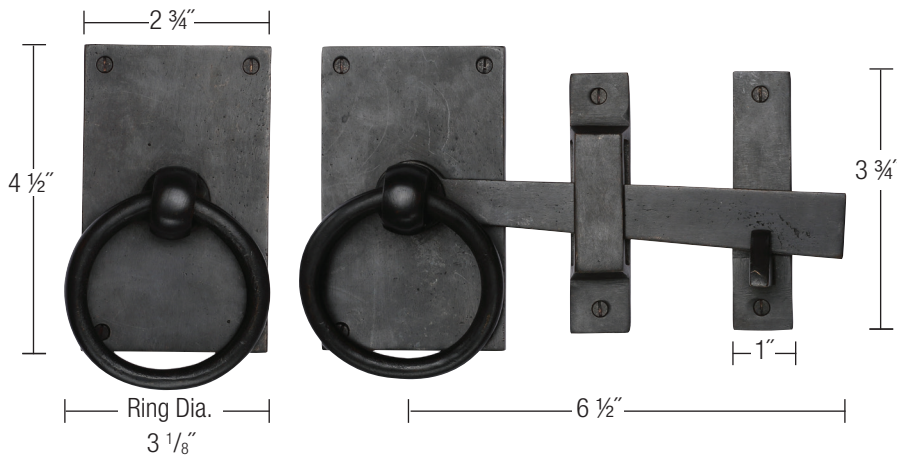

3510.RH Ring Turn Drop Bar RH

3510.LH Ring Turn Drop Bar LH

Price: \$410.00

Handing required. Right hand pictured
Must be used in conjunction with a gate stop.

3514 Dummy Ring on Plate (single)

Price: \$167.00

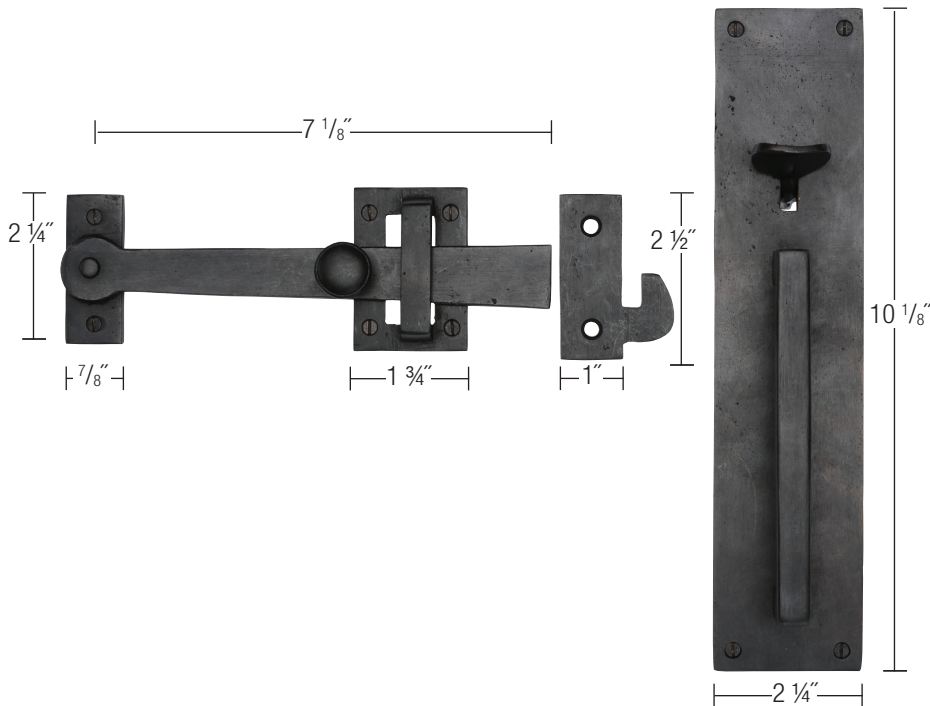

3530 Gate Latch

Price: \$441.00

Must be used in conjunction with a gate stop.
Maximum door thickness: 2 1/2"

3534 Pull Handle on Plate (dummy)

Price: \$301.00

SURFACE BOLTS

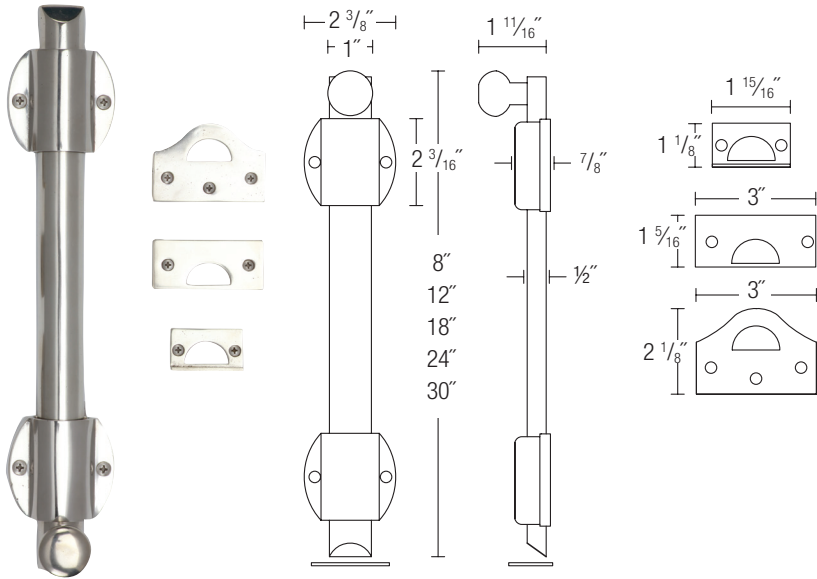

1582 Surface Bolt

ITEM	SIZE	PRICE
1582.8	8"	\$258.00
1582.12	12"	\$293.00
1582.18	18"	\$344.00
1582.24	24"	\$386.00
1582.30	30"	\$502.00

- 1" throw
- All three strike plates included

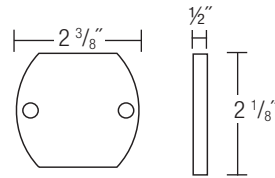

1582-RISER Riser Plate

Suitable for 8" to 30" 1582 surface bolts
 Price: \$28.60

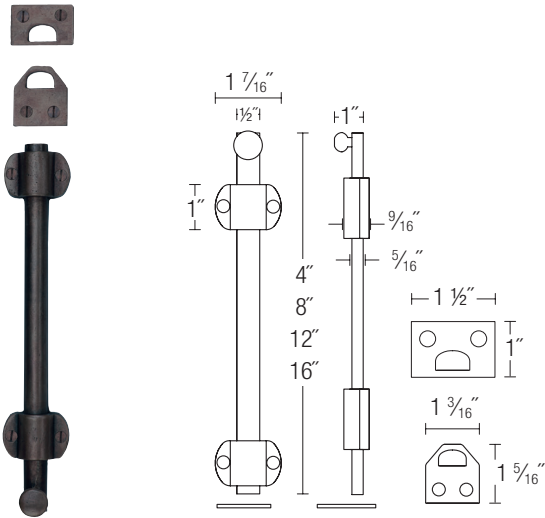

1571 Mini Surface Bolt

ITEM	SIZE	PRICE
1571.4	4"	\$179.00
1571.8	8"	\$215.00
1571.12	12"	\$248.00
1571.16	16"	\$282.00

- 1" throw
- Two strike plates included

CANE BOLT, HOOK & EYE



1593 Cane Bolt

ITEM	SIZE	PRICE
1593.12	12"	\$261.00
1593.18	18"	\$297.00
1593.24	24"	\$335.00

- Bracket size: 2" x 2"
- Strike size: 2 $\frac{9}{16}$ " x 2"
- 2" throw
- Rod diameter: $\frac{1}{2}$ " for 12" and 18" bolts
 $\frac{3}{4}$ " for 24" bolt



1530 Hook & Eye

ITEM	SIZE	PRICE
1530.4	4"	\$61.50
1530.6	6"	\$67.80
1530.9	9"	\$79.10
1530.12	12"	\$89.00

- Bracket size: 1 $\frac{1}{2}$ " x 1 $\frac{1}{2}$ "

WINDOW HARDWARE



990.13 Casement Stay

Arm length: 12 3/4"

Price: \$178.00



1110 Sash Lift

Base: 2 1/4" x 1"

Overall height: 1 3/4"

Price: \$32.70



1120 Sash Lock

Width : 2 1/2"

Price: \$69.00



129 Casement Fastener

2" x 1 1/8"

Price: \$69.00

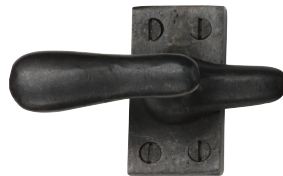

127 Casement Fastener

2" x 1 1/8"

Price: \$69.00

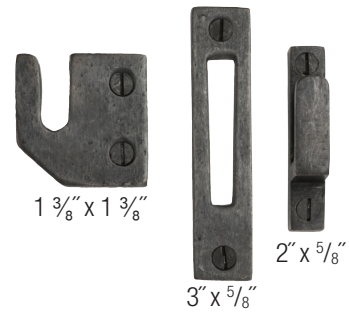

1 3/8" x 1 3/8"

3" x 5/8"

2" x 5/8"

Three strike plate included with all casement fasteners



126 Casement Fastener *

Handing required

Handle length: 3 1/8"

Backplate: 2 1/8" x 1 1/8"

Price: \$152.00



128 Casement Fastener *

Handing required

Handle length: 3 1/4"

Backplate: 2 1/8" x 1 1/8"

Price: \$152.00

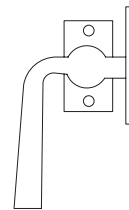

Right-hand window

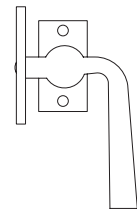

Left-hand window

* Photos depicts handle for left-hand window, also available for right-hand window

SOLID BRASS HINGES

GENERAL INFORMATION

- Full mortise, plain bearing hinges manufactured from solid brass extrusions to current ANSI template specifications. Brass base ensures excellent strength and precision tolerance.
- There may be a slight variation in texture and color between the hinge and the Solid Bronze product
- Supplied as standard with button finials

TECHNICAL FEATURES

- Pin manufactured from grade 304 stainless steel to prevent corrosion
- Finials threaded into barrel of hinge to prevent pin from rising
- Hinges beveled on inside leaf to obtain tight fit when viewing in closed position
- Template screw hole location for use with wood doors and frames



Solid Brass Hinge - Distressed



HIN-F-BAL HIN-F-ACR HIN-F-STP

Item No.	Description	Wt. /box	Thickness	Screws Included
HIN3535	3 ½ x 3 ½" Plain Bearing Hinge	1.4 lb	0.123"	6x #10 x 1" screws per hinge
HIN4040	4 x 4" Plain Bearing Hinge	1.8 lb	0.130"	8x #12 x 1 ¼" screws per hinge
HIN4545	4 ½ x 4 ½" Plain Bearing Hinge	2.1 lb	0.134"	8x #12 x 1 ¼" screws per hinge

Item No.	Description		Price (BZ/NB/WL/WM)	Price (Black)
HIN3535	3 ½ x 3 ½" Plain Bearing Hinge	Each	\$58.40	\$51.80
HIN4040	4 x 4" Plain Bearing Hinge	Each	\$62.50	\$55.40
HIN4545	4 ½ x 4 ½" Plain Bearing Hinge	Each	\$69.40	\$58.40
HIN-F-BAL	Ball Finial	Pair	\$19.60	\$17.50
HIN-F-STP	Steeple Finial	Pair	\$19.60	\$19.60
HIN-F-ACR	Acorn Finial	Pair	\$19.60	\$19.60

Replacement Parts

HIN-F-BUT	Button Finials	Pair	\$16.00
HIN-S-10W	#10 x 1" wood screw	Pack of 6	\$10.00
HIN-S-12W	#12 x 1 ¼" wood screw	Pack of 8	\$14.00

NRP option available, \$13.50 list upcharge per hinge

DOOR STOPS



Baseboard Door Stop

ITEM	SIZE	PRICE
130	1 1/2" length	\$39.60
131	3" length	\$45.60
132	4" length	\$52.90



136 Cylindrical Stop

Dia. excluding ring : 1 1/8"

ITEM	HEIGHT	RING HEIGHT	PRICE
136.1	1 1/2"	3/4"	\$56.90
136.2	2"	1 1/4"	\$65.40



1082 Half Button Door Stop

High base plate (1/4")

Overall height 1 1/4"

Price: \$52.50



133 Door Stop with holder

Base dia. : 2 1/2"

Height : 3 7/8"

Hook Length : 2 1/2"

Price: \$127.80



1080 Half Button Door Stop

Low base plate (1/8")

Overall height 1 1/8"

Price: \$49.80



134 Goose Neck Door Stop

2 1/2" x 2 1/2"

Price: \$65.40



1083 Door Holder

Price: \$68.10

DOOR PULL HANDLES

Cabinet hardware and appliance/door pull pricing is published in our dedicated Cabinet Hardware catalog.



1360 Pull
 21 1/4" x 1 5/8"
 Projection.....4 3/8"
 CTC......20"
 Price: \$572.00

1360-BTB
 Back to Back Pair*
 Price: \$1,181.00



1370 Pull
 22" x 1 1/4"
 Projection.....4"
 CTC......18"
 Price: \$663.00

1370-BTB
 Back to Back Pair*
 Price: \$1,363.00

*Maximum door thickness for Back-to-Back fixing: 3"

PULL HANDLES

Cabinet hardware and appliance/door pull pricing is published in our dedicated Cabinet Hardware catalog.



1150 Offset Pull
 12 3/8" x 2"
 Projection: 2 1/2"
 Price \$228.00
 For Back-to-Back application, order two pulls (surface mounted)



1155 Pull Handle
 15" x 2 3/8"
 Projection: 2 3/8"
 Price: \$330.00
 For Back-to-Back application, order two pulls (surface mounted)



SQ.G.18 Pull Handle
 18 1/8" x 3"
 Price \$659.00



SP.G.18 Pull Handle
 18 1/8" x 3"
 Price \$659.00



CV.G.18 Pull Handle
 18 1/8" x 3"
 Price \$659.00



MD.G.18 Pull Handle
 18 1/8" x 3"
 Price \$659.00



AG.G.18 Pull Handle
 18 1/8" x 3"
 Price \$659.00

PUSH PLATES



Rectangular



Arched



Curved



Urban



Angular

SUITE	ITEM	SIZE	PRICE	ITEM	SIZE	PRICE
Rectangular	SQ.E.13	13" x 3"		SQ.E.18	18 1/8" x 3"	
Arched	SP.E.13	13" x 3"		SP.E.18	18 1/8" x 3"	
Curved	CV.E.13	13" x 3"	\$211.00	CV.E.18	18 1/8" x 3"	\$320.00
Urban	MD.E.13	13" x 3"		MD.E.18	18 1/8" x 3"	
Angular	AG.E.11	11" x 2 1/2"		AG.E.18	18 1/8" x 3"	

BATHROOM ACCESSORIES

Bath Hardware is available with your choice of the following escutcheons:

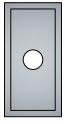

SQ
Rectangular Plate
5 1/8" x 2 1/2"



CV
Curved Plate
5 1/8" x 2 1/2"

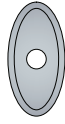

OV
Oval Plate
5 1/8" x 2 1/2"

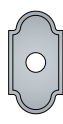

AR
Small Arched Plate
4 1/4" x 2 3/8"



AG
Angular Plate
5 1/8" x 2 1/2"



AS
Angular Rose
2 1/2" x 2 1/2"



RR
Round Rose
2 3/4" dia



MS
Urban Rose
2 1/2" x 2 1/2"



MR
Urban Plate
3 1/2" x 2 1/2"



MD
Urban Plate
5 1/8" x 2 1/2"

ORDERING GUIDE

Patina	Escutcheon	Accessory
BZ Dark Bronze	select from table below	125 Double Ended Paper Holder
WL White Bronze TC Matt Black		145 Paper Holder
WM White Medium NB Natural Bronze		100 Towel Ring
		150 Towel Rail
		410 Robe Hook

For example to order a Robe Hook with 5 1/8" x 2 1/2" (SQ) escutcheon in Natural Bronze (NB) patina, use: NB.SQ.410

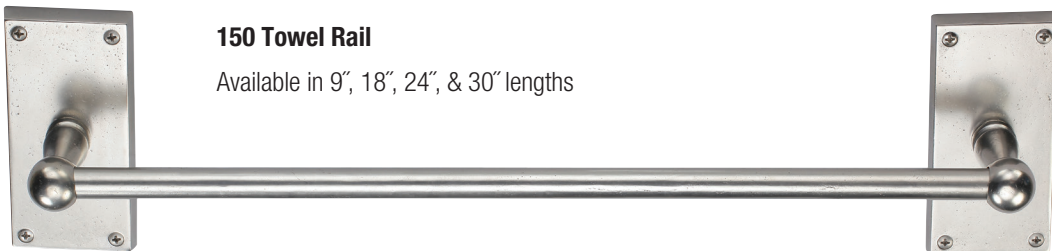

150 Towel Rail

Available in 9", 18", 24", & 30" lengths

PRICE

	9"	18"	24"	30"
SQ.150				
CV.150				
MD.150				
OV.150	\$298.00	\$315.00	\$332.00	\$348.00
AG.150				
MR.150				
AR.150				
MS.150				
AS.150	\$236.00	\$253.00	\$270.00	\$287.00
RR.150				

BATHROOM ACCESSORIES



100 Towel Ring
Ring Dia. 6 1/2"

	PRICE
SQ.100	\$176.00
CV.100	
MD.100	
OV.100	
AG.100	
MR.100	
AR.100	\$155.00
MS.100	
AS.100	
RR.100	

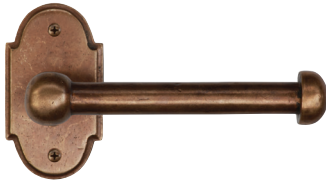

145 Single Ended Toilet Paper Holder

	PRICE
SQ.145	\$289.00
CV.145	
MD.145	
OV.145	
AG.145	
MR.145	
AR.145	\$250.00
MS.145	
AS.145	
RR.145	

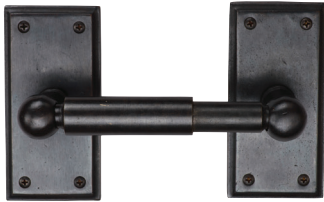

125 Double Ended Toilet Paper Holder

	PRICE
SQ.125	\$299.00
CV.125	
MD.125	
OV.125	
AG.125	
MR.125	
AR.125	\$258.00
MS.125	
AS.125	
RR.125	



410 Robe Hook

	PRICE
SQ.410	\$138.00
CV.410	
MD.410	
OV.410	
AG.410	
MR.410	
AR.410	\$112.00
MS.410	
AS.410	
RR.410	

BATHROOM ACCESSORIES



177 Towel Ring

Ring Size: 5 7/8" x 5 7/8"
 Projection: 2 3/4"
 Price \$179.00



175 Single Ended TP Holder

Length: 6 1/8", Projection: 3 5/8"
 Price.....\$228.00



178 Robe Hook

Base Dia: 1 1/2", Projection: 2 3/8"
 Price \$106.00



176 Towel Rail

Base Dia: 1 1/2", Projection: 2 1/2"

ITEM	SIZE	PRICE
176 9	9"	\$217.00
176 18	18"	\$234.00
176 24	24"	\$251.00
176 30	30"	\$269.00

HOOKS



407 Hook
 3 1/4" x 1 1/4" – projection 3 1/4"
 Price: \$61.50



408 Hook
 1" x 2 3/8" – projection 2"
 Price: \$48.70



395 Hook
 1 5/8" x 2" – projection 2 1/4"
 Price: \$48.70



387 Hook
 1 1/8" x 1 3/4" – projection 2 5/8"
 Price: \$42.20



386 Hook
 2 3/4" x 1 3/8" – projection 1 1/2"
 Price: \$53.00



409 Hook
 1" x 5 1/8" – projection 3 1/4"
 Price: \$61.50



405 Hook
 6 1/4" x 2" – projection 2 1/2"
 Price: \$65.90



400 Hook
 1 5/8" x 5 3/4" – projection 3 1/4"
 Price: \$61.50



404 Hook
 1 3/8" x 4 5/8" – projection 3 3/4"
 Price: \$61.50



406 Hook
 5 1/8" x 1 1/4" – projection 1 7/8"
 Price: \$61.50

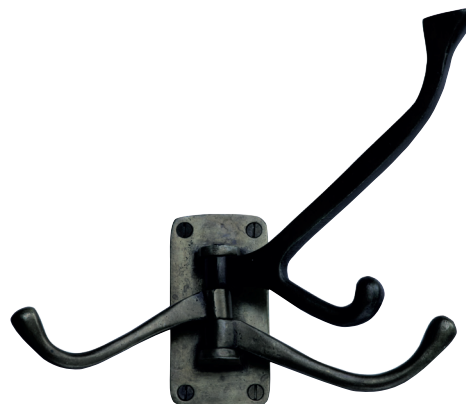

397 Hook
 3 1/4" x 1 5/8" – projection 5 3/4"
 Price: \$91.70

DOOR KNOCKERS



1225 Large Lion Knocker

Diameter 8"

Thru Bolted

Price: \$655.00



1220 Small Lion Knocker

3 7/8" x 6 3/4"

Thru Bolted

Price: \$246.00



1275 Circular Knocker

Escutcheon Diameter 1 3/4", Ring Diameter 7"

Surface Mounted

Price: \$289.00



1230 Square Door Knocker

Escutcheon Size: 2 1/8" x 2 1/8"

Ring Size: 7 1/2" x 6 1/2"

Surface Mounted

Price \$333.00

HOUSE NUMBERS



4" Traditional Numerals

Concealed mount

ITEM	SIZE	PRICE
155 1		
155 2		
155 3		
155 4		
155 5	4"	\$33.60
155 6		
155 7		
155 8		
155 9		
155 0		

6" Traditional Numerals

Concealed mount

ITEM	SIZE	PRICE
156 1		
156 2		
156 3		
156 4		
156 5	6"	\$39.30
156 6		
156 7		
156 8		
156 9		
156 0		



4" Contemporary Numerals

Surface mounted

ITEM	SIZE	PRICE
165 1		
165 2		
165 3		
165 4		
165 5	4"	\$39.30
165 6		
165 7		
165 8		
165 9		
165 0		

6" Contemporary Numerals

Surface mounted

ITEM	SIZE	PRICE
166 1		
166 2		
166 3		
166 4		
166 5	6"	\$45.90
166 6		
166 7		
166 8		
166 9		
166 0		

BELL BUTTONS, CLAVOS AND STRAP HINGES

SUPPLIED WITH ILLUMINATED BUTTON



RD1184
Diameter 2 1/2"
Price: \$79.10



SQNE1180
4 1/2" x 1 1/2"
Price: \$79.10



MDNE1189
4 1/2" x 1 1/2"
Price: \$79.10



SR1183
5" x 2 1/2"
Price: \$94.80



121 Clavos

ITEM	SIZE	PRICE
121.1	1"	\$21.60
121.1 1/4	1 1/4"	\$24.30
121.1 1/2	1 1/2"	\$27.10



411 Strap Hinge

ITEM	SIZE	A	B	PRICE
411.18	18"	2 5/8"	5 1/4"	\$165.00
411.24	24"	3"	7"	\$197.00



412 Strap Hinge

ITEM	SIZE	A	B	PRICE
412.23	22 7/8"	3 15/16"	2 3/8"	\$260.00

SWITCH & OUTLET COVERS

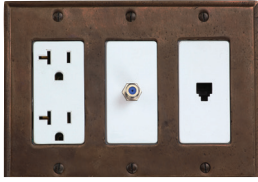

SQ.DSC3
6 1/2" x 4 1/16"

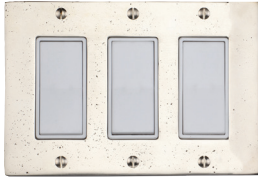

MD.DSC3
6 1/2" x 4 1/16"

DECORA COVER

		URBAN	RECTANGULAR	PRICE
single gang	2 7/8" x 4 1/16"	MD.DSC 1	SQ.DSC 1	\$43.70
double gang	4 1/16" x 4 1/16"	MD.DSC 2	SQ.DSC 2	\$68.10
triple gang	6 1/2" x 4 1/16"	MD.DSC 3	SQ.DSC 3	\$93.90
quad gang	8 7/16" x 4 1/16"	MD.DSC 4	SQ.DSC 4	\$116.70



SQ.SC2
4 1/16" x 4 1/16"



MD.SC2
4 1/16" x 4 1/16"

TOGGLE SWITCH COVER

		URBAN	RECTANGULAR	PRICE
single gang	2 7/8" x 4 1/16"	MD.SC 1	SQ.SC 1	\$47.30
double gang	4 1/16" x 4 1/16"	MD.SC 2	SQ.SC 2	\$71.50
triple gang	6 1/2" x 4 1/16"	MD.SC 3	SQ.SC 3	\$95.90
quad gang	8 7/16" x 4 1/16"	MD.SC 4	SQ.SC 4	\$120.20



MD.OC1
2 7/8" x 4 1/16"



SQ.OC1
2 7/8" x 4 1/16"

OUTLET COVER

		URBAN	RECTANGULAR	PRICE
duplex	2 7/8" x 4 1/16"	MD.OC 1	SQ.OC 1	\$44.40



SQ.BP
2 7/8" x 4 1/16"



MD.BP
2 7/8" x 4 1/16"

BLANK PLATE COVER

		URBAN	RECTANGULAR	PRICE
single	2 7/8" x 4 1/16"	MD.BP 1	SQ.BP 1	\$50.10
double	4 1/16" x 4 1/16"	MD.BP 2	SQ.BP 2	\$74.40

Ashley Norton

210 West Parkway Suite 1
Pompton Plains, NJ 07444
United States

Tel: (973) 835 4027
Toll Free: (800) 393 1097
Fax: (800) 393 1098

ashleynorton.com
info@ashleynorton.com

Printed in United Kingdom