

Black Hawk

A white circle containing a stylized black hawk in flight, facing right. The hawk is depicted with sharp, angular wings and a tail, with several short lines trailing behind it to suggest motion. The circle is positioned between the words 'Black' and 'Hawk' in the main title.A horizontal black arrow pointing to the left, positioned below the word 'Black' and above the word 'Hawk'. The arrow has a simple shaft and a three-feathered fletching at the left end.

by

CRAVOTTA BROS., INC., Third St., East McKeesport, Pa.

Manufacturers of the
World's Finest and Most Complete Line of
ARCHERY EQUIPMENT, WATER SPORTS, WINTER SPORTS
and Other Sporting Goods Equipment

DISTRIBUTED BY

To Our Customers, the Sporting Goods Dealer and Jobber

We firmly believe that the Sporting Goods Dealer of the United States serves the most discriminating clientel in the world, and with this belief in mind, we have strived and are striving to supply you with a complete line of the finest archery tackle that can possibly be produced and assembled for distribution anywhere.

Our bows have a history of many years of research and design by some of the best known technicians of our times. They have not been manufactured merely as another item to be produced and sold, but are the fruits of the skill of these technicians; the careful design to achieve the ultimate; the rigid specifications of tested prime materials combined with the skill of the bowyer's art to achieve a bow that will give the ultimate in cast and in smoothness, in speed and in impact, a bow that is truly a jewel among bows. We are proud of the results, and grateful to the sportsmen for their ever increasing demand for Black Hawk products—a demand that has indeed forced us to expand our production facilities many times in the past years, in order that we can better serve these demands.

We have found through exhaustive research, that a bow properly designed and properly balanced must, in order to achieve perfection, be produced by

a combination of materials that, fortunately for the archers sake, have been made available in the last few years by the rapid technological advances in the field of laminates and resins, and skillful design and craftsmanship. We use only the highest quality of selected hardwoods, high elevation maple, osage, walnuts and other semi-precious woods in our bows, carefully cut and tapered in our own shops, under skillful supervision, combined with carefully made and selected glass backing and facing, and welded with the finest resins available.

In the following pages, you will find listed and pictured the finest equipment available for your display and sales to your customers, carefully manufactured Black Hawk equipment, that has undergone the rigid tests that our bows have, each item a gem in its own field—Black Hawk Arrows, Black Hawk Accessories, Black Hawk Aluminum (that has swept the country), Targets, Nocks and Points, Black Hawk Strings, and many other items manufactured by us, also the finest leather goods available, combined with accessories, in short a complete line of archery equipment that will eliminate all your headaches. You can fully stock your shop from one source, with the gratifying knowledge that you have the best for your customers, and best for yourself.



VITAL INFORMATION TO BUYERS

NOTICE—On any drop shipment made from the factory less than \$50.00 list value there will be a service charge of \$2.50 per shipment.

NOTICE—On any shipment with a list price of less than \$20.00 there will be a service charge of \$2.50.

NOTICE—All prices in this book are based on existing tax conditions. Should additional federal and (or) state taxes be levied such taxes will be added to all invoices.

All prices are F.O.B. East McKeesport, Pa.

On orders, net cost from \$250 to \$500, 50% Freight Allowance—Motor Freight.

On orders of \$500 or more net, Full Freight Allowance—Motor Freight.

All freight shipments are shipped Collect.

Freight rate will be based on lowest cost transportation, which is normally motor freight.

When customer requests other methods of shipment, and his orders are within the boundaries of freight allowances, said allowances will be based on lowest cost of transportation—difference in freight costs to be paid by customer.

RETURNS—No returns accepted unless permission has been prior granted by factory. All returns must be **freight prepaid**, if not **prepaid**, no shipment will be accepted at factory. All returns must be in original container, not marred or marked, when returns are acceptable, a 10% charge of value will be debited to your account for re-inventory and service charge.

All C.O.D. Orders—25% Deposit Required.

Any orders on open account must be accompanied by references or a good credit rating with Dunn & Bradstreet or the Credit Bureau.

Please allow us time to check your Credit Rating.

Prices subject to change without notice.

We reserve the right to change specifications of any merchandise listed in this catalog without notice to the customer.

For the TOPS in BOWS by *Black Hawk*

B-100—BLACK HAWK® CHIEF

The ultimate in top quality bows—unequaled for target, unexcelled for field—an excellent hunting bow. Constructed from precision ground hard rock maple laminations, combined with the finest of fiber glass facing and backing. Adhesives are of the epoxy family, formulated specifically for the manufacturing of our bows. Features true center shot, amazing speed and flat trajectory—beautiful riser, made of rare exotic woods, pistol grip, 7" window, full true working recurves.

Guaranteed for two (2) years, first three months unconditional (please read guarantee card attached to every bow carefully and fulfill requirements.)

Bow length 69". String length 64½". Weights, 30# to 60# at 28". Weights over 60#—on special order, add \$5.00 to list on special weights. Available for right or left hand.

Packed 1 bow to carton—approximate shipping weight 2½#.

List Price \$74.95

B-100S—BLACK HAWK® CHIEF SCOUT

Not illustrated—Same bow and specifications and design as the Black Hawk Chief, except that bow length is 66"; String length is 62". Available in weights from 30# to 60#; for additional weight over 60# add \$5.00 to list. Available in right or left hand.

List Price \$74.95

- * PRECISION DESIGNED
- * SKILLFULLY CRAFTED
- * PROPERLY BALANCED
- * PRIME MATERIALS
- * FACTORY GUARANTEED
- * FACTORY TESTED

B-101—BLACK HAWK® HORNET SPECIAL

One of the fastest bows on the market, unexcelled as a hunting bow. Constructed of the finest hard rock maple laminations—precision ground, combined with top quality fiber glass and backing. Adhesives are of the epoxy family formulated specifically for the manufacturing of our bows. Features full working recurves, true center shot, beautiful riser made of combinations of rare exotic woods, pistol grip—7" window.

Guaranteed for two (2) years, first three months unconditional (please read guarantee card attached to bow and fulfill all requirements.)

Bow length 66". String length 62". Weights 30# to 60# at 28". Weights over 60# on special order—add \$5.00 to list price. Available in right or left hand. Packed 1 bow to carton—approximate shipping weight 2½#.

List Price \$64.95



BLACK HAWK BOWS



B-101-S—BLACK HAWK® SHORT HORNET

A bow designed with the bow hunter in mind; extremely compact, for ease in handling in the field; fast and accurate. Constructed using the finest of materials and workmanship. Laminations are made of top hard rock maple, fiberglass (the finest epoxy glass available, used in backing and facing) and assembled with the use of specific formulated epoxy cement.

Features full working recurves, true center shot, beautifully designed handle with pistol-grip riser, 7" window.

Guaranteed for two (2) years, first three months unconditional (please read guarantee card attached to every bow carefully and fulfill requirements.)

Bow length 57". Bow string 53½". Available in weights up to 60# at 28" standard. Weights above 60#, add \$5.00 to list; and available as custom bow.

Packed: 1 bow to carton; approximate shipping weight, 2½#.

Left or right hand bows; please state if left-hand bow is desired.

List Price **\$59.50**

-
- * PRECISION DESIGNED * FACTORY GUARANTEED
 - * SKILLFULLY CRAFTED * PROPERLY BALANCED
 - * PRIME MATERIALS * FACTORY TESTED
-

B-102—BLACK HAWK® WARRIOR

A beautiful all around bow for the discriminating archer. Constructed with a combination of precision ground top quality, hard rock maple lamination, combined with the finest of glass backing and glass facing. Riser made from exotic cherry or maple. Features true center shot, amazing speed and flat trajectory. True working recurves—7" window, pistol grip, a beautiful bow. Guaranteed for two (2) years—three months unconditional.

Bow length 66". String length 62". Weights 30# to 60# at 28". Weights 60# on special order—add \$5.00 to list price.

Packed 1 to a carton—approximate shipping weight 2½#.

Available in right or left hand.

List Price **\$48.00**



BLACK HAWK BOWS



B-103—BLACK HAWK® BEE

A medium price bow. Price does not reflect the beauty, quality and shooting performance. Constructed with a combination of precision ground laminations, combined with beautiful fiber glass facing and backing. Features 7" window, true center shot, riser made of exotic hard wood, beautifully finished, full working recurve. Guaranteed for two (2) years—first 3 months unconditional.

Bow length 66". String length 62". Weights 30# to 60# at 28". Weights over 60# on special order, add \$5.00 to list price. Packed (1) to carton—approximate shipping weight 2½#.

Available in right or left hand.

List Price **\$35.95**

-
- * FACTORY GUARANTEED * FACTORY TESTED
 - * PROPERLY BALANCED * PRECISION DESIGNED
 - * SKILLFULLY CRAFTED * PRIME MATERIALS
-

B-105—BLACK HAWK® YELLOW JACKET

Extremely fast, accurate, deflex limb bow, effective for target, field and hunting. Recommended for bow fishing. Features glass backing and facing, maple laminations, forward grip—7" window, maple riser.

Finest bow of its type on the market.

Guaranteed for two (2) years, first three months unconditional (please read guarantee card attached to every bow carefully and fulfill requirements.)

Bow length 66". String length 62". Weights: 30# to 60# at 28" draw. Weights over 60# on special order—add \$5.00 to list price.

Available in right or left hand. Packed (2) to carton—approximate shipping weight per carton 5#.

List Price **\$24.95**



BLACK HAWK BOWS



B-106—BLACK HAWK® SCORPION

A must for your display shelves. An amazing bow for the money; one of the most rapid movers on the market. Features glass backing and facing, maple laminations, deflexed limbs, maple riser with cut in arrow rest (not plastic arrow rest), 6" window, plastic tape grip. A wonderful bow for women, children, school archery ranges—rugged and beautiful, recommended for bow fishing. Available in right or left hand.

Bow length 60". String length 56". Weight 20# to 50#.

Guaranteed for two (2) years, first three months unconditional (please read guarantee card attached to every bow carefully and fulfill requirements.)

Packed (2) bows to carton—approximate shipping weight 2½#.

List Price **\$19.95**

- * PRECISION DESIGNED
- * SKILLFULLY CRAFTED
- * PRIME MATERIALS
- * FACTORY GUARANTEED
- * PROPERLY BALANCED
- * FACTORY TESTED

B-107—BLACK HAWK® MOSQUITO

This is the only laminated, true working recurve bow on the market priced so amazingly low. Designed for children, ages 6 to 14. Features maple laminations, composition facing and backing, straight handle, cut in arrow rest in riser, nylon bow nocks and dacron string.

A must to complete your line of top quality bows to fit every need and every age. Weights from 15# to 30# at 25" draw. Bow length 54". String length 50". Approximate shipping weight 2½#. Packed (2) bows to carton.

Available in right or left hand.

List Price **\$10.95**

Black Hawk® Archery Sets

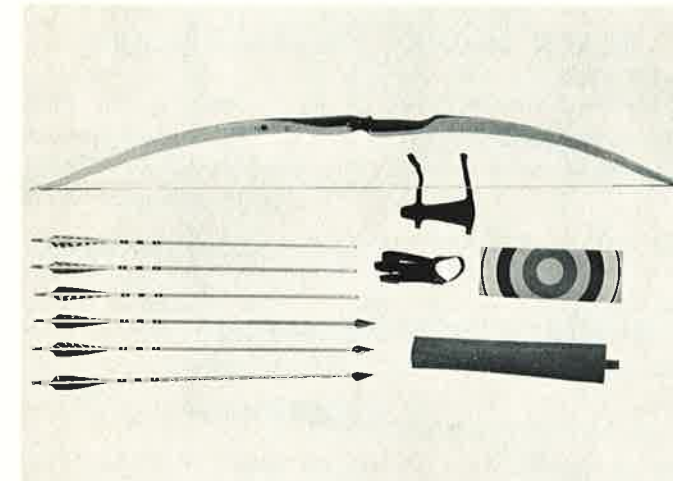

BS-206-H—BLACK HAWK® SCORPION HUNTING SET (Not Illustrated)

A beautiful hunting set, same as the BS-206-T set, except that set consists of Scorpion bow, 3 hunting arrows, 3 field arrows matched for bow weight, one 301 arm guard, one 510-K glove and one 600S quiver, beaver grained, genuine leather.

Approximate shipping weight 3#. List Price **\$31.95**

BS-206-T—BLACK HAWK® SCORPION TARGET SET (Illustrated)

A beautiful archery set for the price-conscious buyer. A perfect set for the lady-archer. Set consists of the beautiful Scorpion bow, one 301 arm guard, 6 target arrows spined to match bow, one 510K glove, and one 660-S beaver grained genuine leather quiver.

Approximate weight in cartin 3#. List Price **\$29.95**

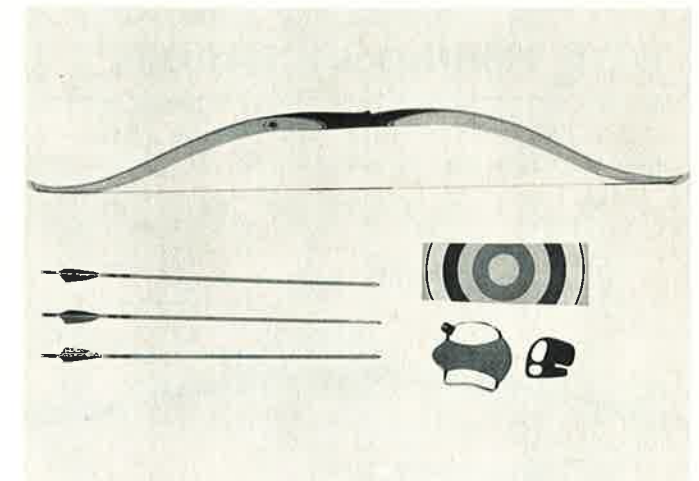

BS-207—BLACK HAWK® MOSQUITO ARCHERY SET

A beautiful complete archery set for children from 6 to 14 years of age, consisting of a weighted mosquito bow, dacron string, 3-port Orford Cedar target arrows, 1 leather tab, 1 leather arm guard, 1 belt quiver and 1 paper target face. Weights 15 to 35 lbs.—packaged in a heavy attractive corrugated carton.

Master carton contains 6 to 12 units.

Approximate shipping weight of 6 unit carton—16 lbs.

Approximate shipping weight of 12 unit carton—31 lbs.

When ordering, please specify weights desired—if not specified then weights will be assorted. List Price **\$14.95** per unit

Complete Black Hawk® Deluxe Sets

BS-200 BLACK HAWK® DELUXE TARGET SET

Set consists of: 1 Black Hawk B-100 Chief, either 69" or 66" as desired; 1/2 dozen Matched Aluminum Arrows; one 701 Bow Case; one 300 Arm Guard; one 520 Glove; one 610 Leather Quiver. List Price **\$100.00**

BS-201-SH—BLACK HAWK® DELUXE HUNTING SET

Set consists of: 1 B-101-S Black Hawk Hunting Bow; 1 Pair of Hush Hush Bow Quivers; one 310 Arm Guard; one 520 Glove; one 700 Bow Case; four Matched #1 Wood Hunting Arrows. List Price **\$74.00**

BS-202—BLACK HAWK® ALL-PURPOSE SET

Set consists of one B-102 Black Hawk Warrior Bow; six #1 Arrows; three Matched Field Arrows; three Matched Hunting Arrows; one 310 Arm Guard; one 520 Glove; one 700 Bow Case; one 600 Side Quiver. List Price **\$65.00**

BS-203—BLACK HAWK® ALL-PURPOSE SET

Set consists of: One B-103 Black Hawk Bee Bow; six Arrows; three Matched Field Arrows; three Matched Hunt Arrows; one 300 Arm Guard; one 510-K Glove; one 700 Bow Case; one 630 L.P. List Price **\$55.50**

BS-203FS—BLACK HAWK® FISH SET

Set consists of: One B-103 Black Hawk Bee Bow; one FDR3 Fish Reel Deluxe and Line; one FA2 Alum Fish Arrow. List Price **\$40.00**

BS-205—BLACK HAWK® STRAIGHT BOW SET

Set contains: One B-205 Black Hawk Yellow Jacket Bow; six Matched Field Arrows; one 700 Bow Case; one 301 Arm Guard; one 510K Glove; one 610 P.C.B. Quiver. List Price **\$39.50**

Black Hawk Archery Sets



BOWS RECOMMENDED FOR USE WITH FISHING ACCESSORIES

BLACK HAWK® YELLOW JACKET



List Price \$24.95

BLACK HAWK® BEE



List Price \$35.95

BLACK HAWK® SCORPION



List Price \$19.95

ARCHERY FISHING ACCESSORIES

For the utmost in thrills and excitement, try archery fishing during the seasons permitted in your area. Fish for all rough fish, and fish permitted by your own state laws. Blackhawk Scorpion, Yellow Jacket and Bee bows make ideal bows to use, combine these with the following famous Blackhawk Bow Fishing Accessories and you have the finest available.

FDR3—A large fishing reel, easily attached to your bow by taping the metal straps of the reel to the bow. Reel is approximately 5" in diameter, made to sight and shoot thru the reel at the fish—almost impossible to miss. Reel is made of tough plastic with built-in clip to hold line prior to shooting. List \$2.95

FRL2—An economical fish reel easily attached to your bow with tape, made of plastic, comes equipped with heavy test fish line. List \$1.75

FA2—Famous Blackhawk solid Aluminum Fish Arrow, equipped with Blackhawk steel removable fish point arrow heavy enough for deep penetration in water without planing. Arrow may bend—is easily straightened—will not break. List \$2.00 each

FA2-G—Blackhawk new glass arrow, equipped with Blackhawk steel Fish point. Durable, practically indestructible. List Price \$2.25 each

FS4—Blackhawk economical bow fish set consists of small plastic fish reel with line, aluminum fish arrow. List \$3.75

FS4-G—Same as FS4 except glass fish arrow instead of Aluminum. List Price \$4.00 each

FP1—Blackhawk Fish Point. Made of the finest steel, head is in three (3) parts—steel ferrule, head and barb. Head screws on to ferrule for easy removal of arrow after shooting fish. Ferrule available to fit shafts from 1/4" to 11/32" head fits on all ferrules. Cadmium plated. List Price \$.50 per point, includes extra barb

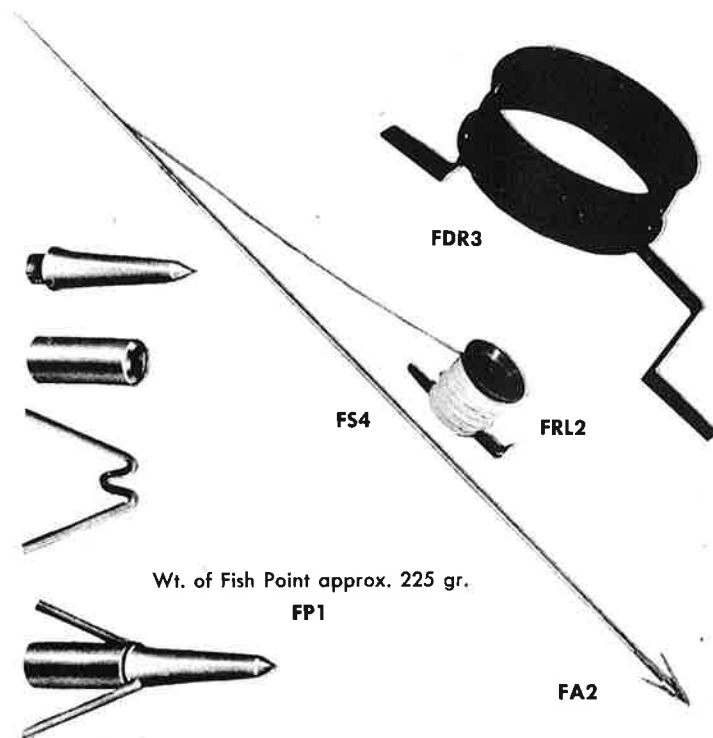

Wt. of Fish Point approx. 225 gr.

FP1

FS4

FDR3

FRL2

FA2

Black Hawk

World's Finest Archery Equipment

ALUMINUM ARROWS

Custom aluminum arrows produced from Alcoa Aluminum stock that is prepared for us by Aluminum Company of America to meet the rigid standards of Alcoa and our specifications, and reprocessed by us to produce the ultimate in top grade Aluminum Arrows.

Our choice of crests and feathers—add \$2.00 to list if custom work is desired. In Aluminum Hunting arrows, your choice of hunting heads shown in our catalog, except the Rocketeer IV, for which add \$1.00 per dozen. Standard Package—1 doz. arrows per carton and 1/2 dozen arrows per cartons.

List Price

- A-1100 S—Shafts without points \$17.00 per doz.
- A-1100 SPA—with points attached \$19.50 per doz.
- A-1100 ST—Shafts with standard taper \$18.00 per doz.
- A-1100 TP—Target points for aluminum arrows \$1.25 per doz.

ARROWS

WHEN ORDERING ARROWS, BE SURE TO SPECIFY WEIGHT OF BOW, ARROW LENGTHS AND TYPE OF HUNTING POINT DESIRED WITH STOCK NUMBER

ALUMINUM ARROW AND ALUMINUM SHAFT CHART

Aluminum arrows or shafts to be ordered by bow weight and arrow length desired. Order by the Code number from the following chart. Par example: If you want 28" arrows for a 40-45 lb. bow, order #1816 @ 28". Hunting arrows should take the shaft for the next advanced weight.

| Bow Weights | 23" | 24" | 25" | 26" | 27" | 28" | 29" | 30" |
|-------------|------|------|------|------|------|------|------|------|
| 18-20 | | | | | 1616 | 1616 | 1716 | |
| 20-25 | | | | 1616 | 1616 | 1716 | 1716 | |
| 25-30 | | | | 1616 | 1616 | 1716 | 1716 | |
| 30-35 | | | 1616 | 1618 | 1716 | 1716 | 1816 | |
| 35-40 | | 1616 | 1618 | 1618 | 1716 | 1718 | 1816 | 1916 |
| 40-45 | | 1618 | 1618 | 1716 | 1718 | 1816 | 1916 | 1916 |
| 45-50 | 1618 | 1618 | 1718 | 1718 | 1816 | 1818 | 1916 | 2016 |
| 50-55 | 1618 | 1718 | 1718 | 1818 | 1818 | 1820 | 1918 | 2018 |
| 55-60 | | 1718 | 1718 | 1818 | 1820 | 1918 | 2018 | 2018 |
| 60-65 | | 1718 | 1818 | 1820 | 1820 | 1920 | 2018 | 2018 |
| 65-70 | | | | | 1920 | 2018 | 2018 | 2018 |
| 70-75 | | | | | | 2020 | 2020 | |

The first two numerals in above shaft sizes indicate outside diameter in 64ths. The second two numerals indicate wall thickness in 1000ths. Examples: No. 1616 is 1/4" diameter x .016 wall; No. 1816 is 9/32" diameter x .016 wall.

FINISHED ALUMINUM ARROWS

- A-900 T—Aluminum Target Arrows List Price \$29.00 per doz. \$15.00 1/2 doz. (Illustrated)
- A-900 T4—Aluminum Target Arrows, 4 Fletch List Price \$30.00 per doz. \$15.50 1/2 doz. (Not Illustrated)
- A-900 F—Aluminum Field Arrows List Price \$30.00 per doz. \$15.50 1/2 doz. (Not Illustrated)
- A-900 F4—Aluminum Field Arrows, 4 Fletch List Price \$31.00 per doz. \$16.00 1/2 doz. (Not Illustrated)
- A-900 H—Aluminum Hunt Arrows List Price \$33.00 per doz. \$17.00 1/2 doz. (Not Illustrated)
- A-900 H4—Aluminum Hunt Arrows, 4 Fletch List Price \$34.00 per doz. \$17.50 1/2 doz. (Not Illustrated)

PORT ORFORD CEDAR ARROWS—All Blackhawk Port Orford Cedar Arrows are made from the finest precision ground, highly polished straight grained Port Orford Cedar shafts available, manufactured by top skilled artisans and finished with our own brilliant lasting finish. (The finest wood arrows available anywhere.)

No. (1) Blackhawk Arrows (26", 27", 28" lengths) Custom grade. Port Orford Cedar, closely matched in weight and spine, beautifully colored and crested. Packed 1 doz. to box. Please specify bow weight and length of arrow. Fletch 5".

- A-910 T—#1 P.O.C. Target Arrows List Price \$13.95 per doz.
 - A-910 F—#1 P.O.C. Field Arrows List Price \$13.95 per doz. (Not Illustrated)
 - A-910 H—#1 P.O.C. Hunt Arrows List Price \$16.95 per doz. (Not Illustrated)
 - A-910 FH—Consists of 6 matched hunting arrows with Rocketeer IV and 6 matched field arrows. List Price \$15.50 per doz. packed 12 arrows to carton (Not Illustrated)
- A MUST FOR EVERY DEALER'S SHELF**

A-910 HR—#1 P.O.C. Hunt Arrows with Rocketeer IV List Price \$17.95 per doz.

(Cedar Arrows continued on page 10)

No. (2) **ARROWS** (Same specifications as No. (1) except 4½" Fletch Simpler Crest. No orders taken on special specified custom work.

A-920 T—#2 P.O.C. Target Arrows

List Price **\$11.95** per doz.

A-920 F—#2 P.O.C. Field Arrows

List Price **\$11.95** per doz. (Not Illustrated)

A-920 HR—#2 P.O.C. Hunt Arrows with Rocketeer IV Points

List Price **\$15.95** per doz. (Not Illustrated)

A-920 H—#2 P.O.C. Hunt Arrows

List Price **\$14.95** per doz. (Not Illustrated)

No. (3) ARROWS. Fully painted and crested. Port Orford Cedar. Not spined or matched. Recommended for bows up to 45 lbs. Packed 1 doz. per carton or 6 doz. rack per carton. 4" Fletch.

A-930 T—#3 P.O.C. Target Arrows

List Price **\$7.95** per doz. (Not Illustrated)

A-930 F—#3 P.O.C. Field Arrows

List Price **\$7.95** per doz.

A-930 R—#3 P.O.C. Either Target or Field

List Price **\$44.00** per 6 doz. carton (Not Illustrated)

SPECIAL ARROWS. Carefully made of finest materials and with same tolerance as #1 except Port Orford Cedar Shafts. are all 30" lengths—no points furnished. The average craftsman can add these details without special tools and have the finest quality arrows at a substantial saving. Arrows come matched in weight and spine. Packed 1 dozen per carton.

A-940—#2 Special Arrow—no points—full length—4" feather

List Price **\$7.70** per doz.

A-945—#2 Special Arrow—no points—full length—5" feather

List Price **\$8.80** per doz. (Not Illustrated)

No. (4) ARROW (Not Illustrated). For beginners and children, or as throw-aways. Fully painted, crested and fletched with 3" feathers. Port Orford Cedar. Furnished with target points only, in standard packs of 6 dozen. Assortment consists of 2 doz. each 26", 27", 28" arrows. These arrows also available in 1 doz. packed cartons. (Not Illustrated) **\$35.70** per rack

A-950—#4 Target Arrow—packed 1 doz. to box (specify length)

List Price **\$6.50** per doz.

No. 970—FLU-FLU (Not Illustrated). The perfect arrow for shooting at flying targets, or birds. The arrow will fly straight for approximately 30 to 40 yards and then parachute to the ground. Equipped with six 5" uncut feathers, 11/32" shaft size, either field points, target points or blunts. Fully dipped, packed one dozen to box, lengths 24", 26", 28". List Price **\$12.00** per doz.



BLACK HAWK VACUUM ARROWS

A carded arrow set, consisting of three colorful rubber, vacuum tipped, birch arrows, mounted on an attractive board covered with clear polyethelene for eye-appeal and self-selling. Wonderful, safe, exciting arrows for the child archer.

List Price per card of

3 Arrows \$0.59

Packed: 24 Cards to Carton

A-950 R—#4 TARGET ARROW—Packed 6 doz. to display box List Price **\$35.70** per ½ doz.



A-960 R—TARGET ARROW—Packed 6 doz. to rack consisting of 2 doz. each 22", 24", 26". 6 doz. rack. List Price **\$19.20** per rack



Black Hawk Glass Shafts and Glass Arrows

The finest glass arrows and shafts available. Made of unidirectional filament wound fiber glass and especially compounded Epoxy resin. Available either in beautiful white or Sandstone color pigment completely impregnated throughout shafts. Made to withstand rough usage, tough-phenomenal strength-straight-extremely light in weight. No sanding required for fletching, use Black Hawk fletching cement.

Shafts come complete with aluminum nock insert and, either target point inserts or tapered inserts for field points or hunting point application. When ordering please specify type of point insert desired. All inserts and points must be glued with Epoxy Cement. Any good quality two component Epoxy that is available at your hardware store will do the job.

The following table was designed and coded for ease in ordering and is predicated on the spine ranges at 28".

| | | |
|---------------|---------------|---------------|
| A20-20 to 24# | D35-35 to 39# | G50-50 to 54# |
| B25-25 to 29# | E40-40 to 44# | H55-55 to 49# |
| C30-30 to 34# | F45-45 to 49# | I60-60 to 64# |
| | | J65-65 to 69# |

When ordering please order per code—example—if shafts only desired at Hunting weight of 50# order G50w/tapered insert, if target weight desired at 36# @ 28" order just D35.

When completed arrow is desired please order by code and specify length, type of point desired (whether target, field or hunting) and whether three fletch or four fletch.

G-700—Shafts only—full length 32½"—with nock inserts and either target point inserts or tapered inserts for field points or hunting points. List **\$13.95** doz.

G-701—Shafts cut to length with nock inserts and target point inserts or tapered inserts installed. List **\$15.20** doz.

G-703—Black Hawk completed glass target arrows—beautiful cresting—three feather fletch. List **\$24.00** doz.

G-703-4—Complete glass target arrow—beautiful cresting—four feather fletch. List **\$25.00** doz.

G-704—Black Hawk completed glass field arrow—fully crested—three fletch. List **\$25.00** doz.

G-705—Black Hawk glass hunting arrow—three blade point List **\$27.00** doz.

G-705RIV—Black Hawk Glass hunting arrow with Rocketeer IV hunting point. List **\$28.00** doz.

Black Hawk's Target Faces & Target Mats

STANDARD 4-COLOR FACES

Sizes 14" through 48"
Official Heavy Tag Paper



| Code | Size | List Price |
|------|------|------------|
| P-48 | 48" | \$1.69 |
| P-36 | 36" | \$.95 |
| P-24 | 24" | \$.50 |
| P-16 | 16" | \$.20 |
| P-12 | 12" | \$.15 |

OFFICIAL INDOOR FLINT

Heavy Tag



| Code | Size | List Price | Set Inc. |
|------|------|------------|----------|
| B-24 | 24" | \$.20 ea. | 4 |
| B-18 | 18" | \$.15 ea. | 6 |
| B-12 | 12" | \$.10 ea. | 8 |
| B-6 | 6" | \$.04 ea. | 18 |

Set of 36-B36—\$3.20

CORRUGATED FLINT

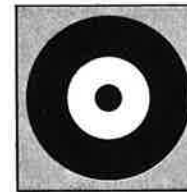

| Code | Size | List Price | No. in Set |
|-------|------|------------|------------|
| CB-24 | 24" | \$.30 ea. | 4 |
| CB-18 | 18" | \$.20 ea. | 6 |
| CB12 | 12" | \$.15 ea. | 8 |
| CB-6 | 6" | \$.08 ea. | 18 |

Set of 36 CB—List \$5.00

OFFICIAL NFAA BLACK HUNTER

Heavy Tag

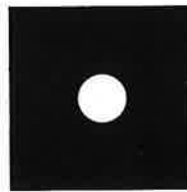

| Code | Sheet Size | Score Area | List Price | Set Inc. |
|-------|------------|------------|------------|----------|
| H-24 | 25" | 24" | \$.45 ea. | 3 |
| H-18 | 25" | 18" | \$.45 ea. | 5 |
| H-122 | 25" | 12" | \$.45 ea. | 1 |
| H-12 | 13" | 12" | \$.15 ea. | 4 |
| H-6 | 7" | 6" | \$.05 ea. | 5 |

Set of 18—List Price \$4.95

OFFICIAL ANIMAL ROUND

Broadhead



| Code | Size | List Price | Set Inc. |
|------|---------|------------|----------|
| OAR1 | 40 x 28 | \$.70 ea. | 3 |
| OAR2 | 28 x 22 | \$.40 ea. | 3 |
| OAR3 | 22 x 14 | \$.30 ea. | 4 |
| OAR4 | 14 x 11 | \$.15 ea. | 8 |

40 x 28 Bear or Moose Set of 18 FACES—\$5.95

28 x 22 Antelope, Mt. Lion or Ram

22 x 14 Raccoon, Goose, Javelina

14 x 11 Pheasant, Prairie Dog, etc.

OFFICIAL FULL COLOR ANIMAL FACES

meets all regulations.



| Code | Size | Animal | List Price |
|-------|------|----------------------|------------|
| CA-24 | 24" | Deer or Mt. Lion | \$.50 |
| CA-18 | 18" | Fox or Turkey | \$.30 |
| CA-12 | 12" | Pheasant or Bobcat | \$.20 |
| CA-6 | 6" | Squirrel or Blue Jay | \$.07 |

Set of 36 FACES—CA-36—\$6.50

Set includes 4 at 24", 6 at 18", 8 at 12", 18 at 6"

BEC—Economy Target Mat—Made of heavy corrugated paper, comes partially assembled, can be assembled by opening the box, pack tightly with rags, paper or straw, then tape box lid shut. An economical target mat that will give many hours of pleasure.

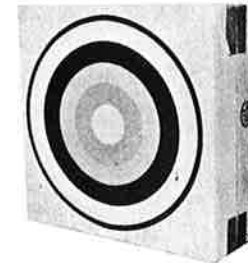

List \$1.00 each

Packed: 15 BEC to Bundle

BEC-F—16" Target Mat—Fully assembled economy Target Mat filled with Black Hawk Chemfoam Arrow Stopper; will stop arrows from bows to 75-lb. weight. Feather-light, easily carried



List \$3.50

Packed: 12 Target Mats to Bundle

B.T.M.—24" Black Hawk's latest in superior Target Mats. A real Arrow Stopper—will stop arrows shot from 80-lb. bows. Feather-light in weight, strong, durable; made of heavy corrugated board, snobute finish, 4-color face, filled with Black Hawk's Chemfoam Arrow Stopper. Size 24" x 24" x 4".



List \$6.00 each

Packed: 12 to Bundle

B.W.S.—Wood Target Stand—Black Hawk's Tripod Wood Stand for easy Target Mounting. Easily assembled.

List \$8.50

Black Hawk

World's Finest Archery Equipment

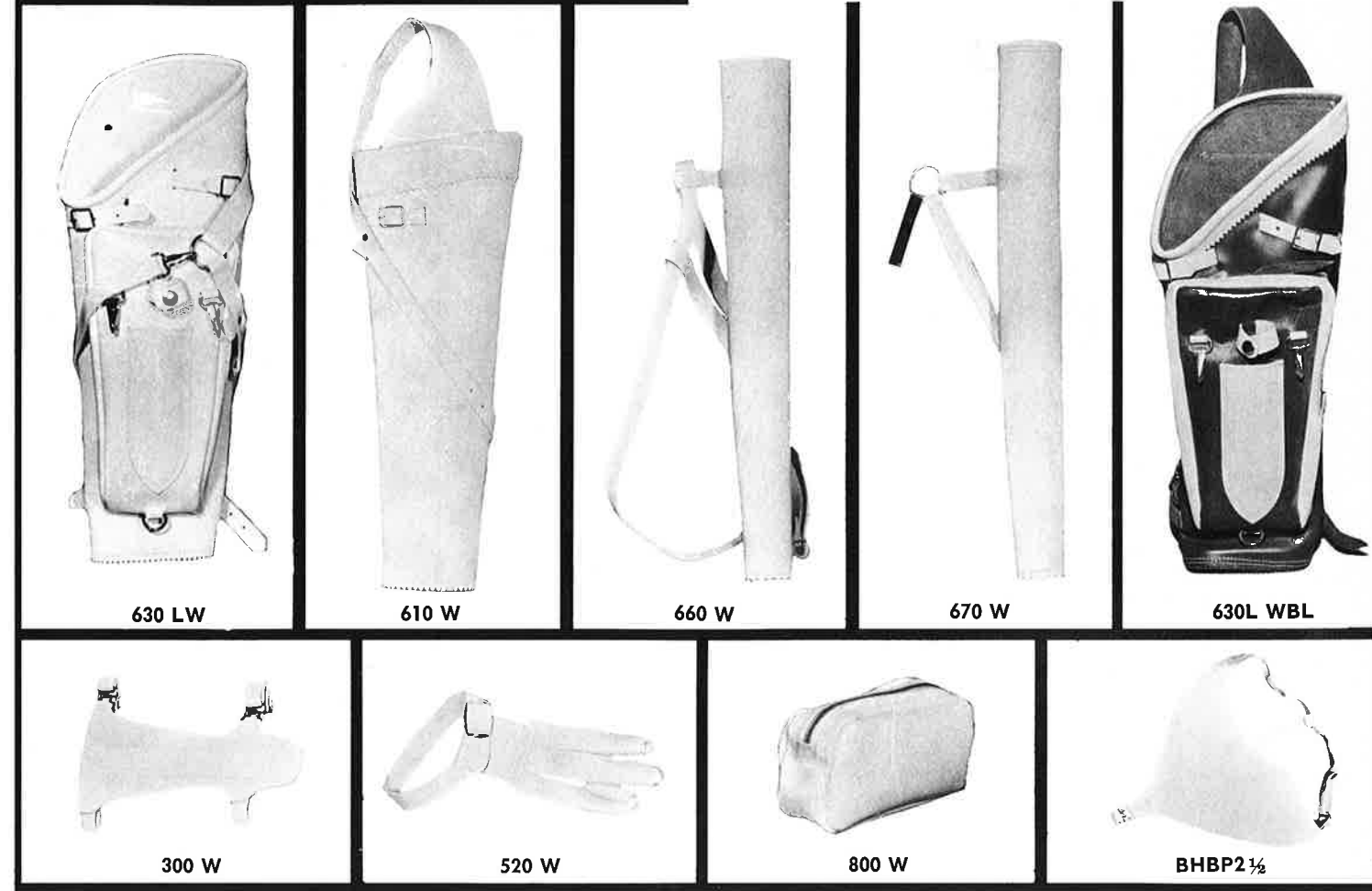

The Black Hawk® line of exquisitely designed luxurious leather accessories. Recommended for the gentler sex. A line of accessories that will compliment any lady archer. Made of top grain selected elk by leather craftsmen. Available in beautiful white, black and white, or in rich black.

630 LW List \$23.95

A beautiful white shoulder quiver separated into three compartments. Will hold 18 arrows—handy large accessory pocket—zippered at top and side so that contents will not spill when opened—file carrier inside pocket to keep file from rusting—snaps on pocket for licenses—knife sheath on pocket—pencil holder on breast strap for ease in marking score.

610 W List \$9.75

An exquisite white, two compartment shoulder quiver.

670 W List \$4.50

Beautiful white side quiver with belt snap.

800 W List \$4.50

An accessories pouch that will fit any belt with top zipper, can be used as purse—a must for all ladies.

630L WBL List \$23.95
Same specifications as 630LW except black and white.

BLACK HAWK® BLOUSE PROTECTOR

BHP2 1/2 List \$2.50

Made of top grained white elk. Used by women archers to keep blouse snug against armpit and breast and prevent string slap on loose blouse.

300 W List \$1.65

A beautiful ladies white arm guard, made of top grade white elk—reinforced with spring steel stay—two elastic arm bands.

520 W List \$2.25

A beautiful white ladies shooting glove. Open end finger with elastic band between glove and arm strap, made of white elk—two sizes only, medium and large.

BLACK HAWK TOP QUALITY QUIVERS

The Quivers are manufactured using the finest, genuine cowhide leather, finished in a smooth, luxurious satin black and tan beaver grain texture, trimmed in dark brown. Secondary strap, in shoulder quivers, buckles to opposite side of quiver, circles waist and snaps to regular shoulder strap, and adjustable for individual comfort, this harness is included on shoulder quivers B630, B630L, B625 and B620. No. B610 and B600 are designed to be used either as shoulder quivers or side quivers, by merely adjusting belts. These Quivers have many fine features such as pencil holders, file holders, knife sheath, snap hooks, and in B630, B630L, B625 and B620 large, easily accessible zippered bags that will carry all necessary items. These Quivers are really luxurious, at extremely low prices; a must for archers at prices that will make them buy.

PLEASE SPECIFY COLOR AND CODE



RIGHT
OR
LEFT
HAND

B630
List \$15.45



RIGHT
OR LEFT
HAND

B610
List \$7.50



BHPQ List \$1.50



WITH
ACCESSORY
POCKET

BHPQP List \$2.95



LADIES
AND
SMALL MEN
RIGHT OR
LEFT HAND

B630L
List \$13.50



Side Quivers with Pocket, made from top genuine cowhide leather. 17" long, with 8" zippered Accessory Pocket. Metal belt loop. Available in black or two-tone brown.

B-605
List \$6.75



BOW CASE

Beautiful canton flannel bow case. Leather trimmed with leather ties. Available in 62", 66", 72".

B701 List \$2.25
Same specifications as above, except wide enough to fit any large handled modern bow. 6" Wide—Lengths: 66" and 72".
B701 List \$2.25



CENTER
BACK

B625
List \$12.45



B660 List \$3.00



B670 List \$3.00



BOW CASE

The Black Hawk No. B702 new tournament bowcase. A deluxe bow case that will fit all tournament bows, made of weatherproof vinyl, flannel lined, with inside pocket for accessories, 36" zipper, center leather handle grip.

B702 List \$9.50



RIGHT OR
LEFT HAND

B620
List \$11.25



B600
List \$4.00



B606
List \$6.25



Black Hawk Ankle Bow Stringer

Black Hawk Ankle Bow Stringer—Easily applied, leather looped, straps to ankle; that makes bracing of any recurve bow simple and guarantees not to twist recurves or injure bow. Easily carried in quiver—quickly applied—longer life to your bow.
BABS List \$1.75



630 L.P.



610 P.C.B.



685



684

BLACK HAWK® VINYL SUPPORTED QUIVERS

The finest of low priced Quivers, made of top quality vinyl supported vulcanized fiber, in rich glossy black, trimmed in beautiful contrasting white, creating a very rich looking durable quiver that any archer would be proud to own, but at a price that any archer can afford. Loads of eye appeal.

630 L.P. Quiver. Same specifications as Blackhawk's deluxe 630L, except made of our new rich vinyl supported material in rich glossy black, cannot be compared at this low, low price. Three compartments to hold your full assortment of arrows.

List \$7.95

610 P.C.B. Quiver. A beautiful economical full sized center back quiver, made of rich black vinyl supported material, two compartments for your convenience, trimmed in genuine leather, double harness, for comfortable nonslip wearing, equipped with full size, zipper fastened, accessory pocket.

List \$6.95

685 Quiver. A beautiful vinyl supported, two compartment shoulder quiver, with large zipper fastened, accessory compartment.

List \$5.95

684 Quiver. An ideal medium sized vinyl supported, two compartment shoulder quiver.

List \$4.25

683 Quiver. Medium sized single compartment belt quiver, made of durable vinyl supported material.

List \$3.50

682 Quiver. Small sized, single compartment quiver, made of vinyl supported material. Ideal for children.

List \$2.75

600-P Quiver. An ideal, rich vinyl supported belt quiver that will hold at least 6 arrows.

List \$1.75

650 Quiver. An ideal child's belt quiver made of vinyl supported material richly trimmed.

List \$1.25

655 Quiver. Small child's belt quiver, durable, good looking, made of vinyl supported material.

List \$1.75



683



682



600-P



650



655

BLACK HAWK LEATHER ACCESSORIES

ARM GUARDS



325—Full protection — wide Cordovan type leather with steel stays—added sewn front length gives full fore arm protection—3 elastic bands. List **\$3.50**



320B—Large, extra width hunting guard with one inch wide steel stay and three leather straps and buckles to fit over large arm area. List **\$3.00**



320—Same as 320B, except having elastic bands instead of leather straps. List **\$2.75**



310—Full length, wide, with one-inch stay for full protection. List **\$2.00**



300—Semi-narrow, tapered design provides coolness, yet ample protection. List **\$1.50**



301—Same as 300, but made of Kip leather, not Cordovan. List **\$1.25**



305—Full length Cordovan arm guard extremely narrow—2 elastic straps. List **\$1.50**



300-S—Extremely short arm guard, 4 1/4" long—2 elastic straps. List **\$1.35**



300-K—Leather guard with Arrabuk lining. Elastic band with hook. List **\$.75**



350—Split grain leather for the kids. With adjustable snap fastener. List **\$.50**

GLOVES AND FINGER TABS

Glove sizes—men—small, medium, large and extra large. Ladies sizes—medium and large only—no left hand needed. Tab sizes—large and small only—left or right hand.



530—Closed-end styled with Cordovan tips. Elastic insert keeps glove back smooth, and finger stalls snug. Relieves wrist-strap tension. List **\$2.25**



520—Open Cordovan tips, elastic insert back. List **\$2.00**



510—Soft fine glove leather and wrist tie. Cordovan open tips. List **\$1.65**



510-K—Leather back with open Cowhide tips. List **\$1.25**



520-S—Single seam glove—same specifications as 520, except fingers have single seam in back. Will not pinch nock. List **\$2.00**



550 Finger Tab—Soft Cowhide finger tab. Available: large and small, right hand or left hand. List **\$.25 each**



1000—Made of very soft suede leather. Available in red or green. List **\$3.45**

Black Hawk

World's Finest Archery Equipment

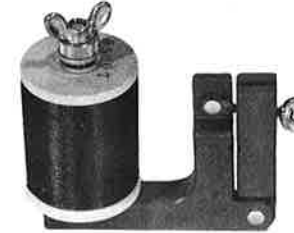

Server.

SS3—Blackhawk Server. Finest server for serving bow strings on the market. Made of tough durable plastic. Easy to use, simple adjustments for positive serving. (Directions with each server.) List Price **\$2.95**

Serving Spools, extra large spools. Available in red, green, rust. List Price **\$.60 per spool**

BHTT4—Famous Blackhawk Tapering Tool. This tool acclaimed by all as the finest tapering tool on the market, designed to fit all points and nocks. Included are four bushings which have tapered sleeves that fit in a tapered hole of the main tool. Bushings are 1/4" 9/32", 5/16" and 11/32" and are slightly oversized to permit clearance of oversized shafts or painted shafts. Blade for cutting is a used injector-type razor blade, available at any drug store. (Directions and descriptive literature with each tool.) Complete tool containing six parts. List Price **\$3.50**

BHB4—Blackhawk Feather Burner. A burner designed for the home craftsman and for home repairs. Comes completely assembled. Completely safe. Does not have transformer. In place of transformer, plug in an electric iron or other appliance in plug shown in base. This will reduce current to the burning wire. Will not work unless appliance is plugged in receptacle. List Price **\$4.95**

BHB1—Blackhawk Bow Sight. Tops in bow sights. Has elevation and windage adjustment set screw. Three different types of apertures. Available in individual sets with directions for use. Each set consists of five pieces. Made of tough plastic. Colors—red, green or yellow. Easily attached to bow with tape. List Price **\$1.50 per set**

Blackhawk Identification Decals—12 decals per sheet. Decals are numbered 1 to 12 inclusive with lines for name and address. An easy device for identifying your arrows, with numbers to identify your shots. Available in five different colors—white, yellow, pink, blue, and green. Very easy to apply. List Price **\$.30 per sheet of 12**

Blackhawk Brush Buttons—For brush proofing bow when stalking in woods and dampening string noise. Fit all bows. Packed in blister bags; packed 12 packs to easel. (See merchandiser section of catalog.) Comes in two sizes. Standard—List Price **\$.60 pair** Super—List Price **\$.70 pair**

G. Q.—Blackhawk Ground Quiver. Tops in ground quivers with many features not found in even more expensive quivers. Made of cadmium-plated steel, spring loop for holding arrows, metal clip for holding bow, cigarette holder and score card holder. List Price **\$3.30**

LRW—Blackhawk Leather Rewrapping for bow handles. Made from genuine soft beautiful tanned leather. Completely skived for ease of application and form fitting of hand. List Price **\$1.00 each**

BHSH—Blackhawk String Holder. Made of genuine leather with elastic band and clip to hold string on to your bow. End slips on bow, elastic band and clip allows string to be held tight without danger of losing. Not illustrated.) List Price **\$.75 each**



Tapering Tool.



Bow Sight.



Brush Buttons



Leather Rewrapping



Identification Decals



Ground Quiver.

World's Finest

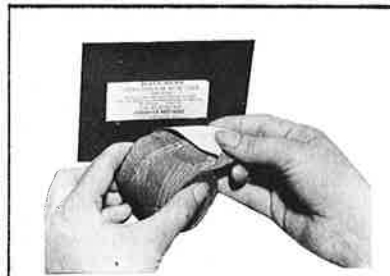

Camouflage Bow Tape.

CATA—Blackhawk Camouflage Bow Tape. A completely camouflage designed bow tape with pressure adhesive backing for ease of application on all bows; easily removed when not in use. Ideal for quick camouflaging of bows during hunting. (Directions with each roll.)

List Price \$1.00 each roll

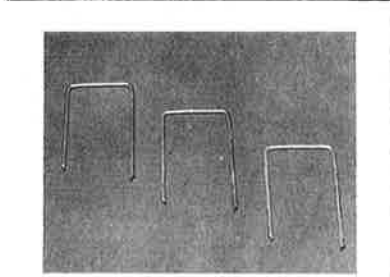

Target Staples.

Blackhawk Tassel—For wiping and cleaning arrows, preserves arrows, keep quiver clean, suspends from quiver. Made of virgin wool yarn. Assorted colors.

List Price \$1.00 each

STAP—Blackhawk Target Staples. Wire staples in fastening target faces to straw mats (four to set).

List Price \$.35 per set

AC6—Blackhawk Arrow Clips. Metal arrow clips with wood screws for display racks and racks for arrows. (Packed 144 to carton)

List Price \$5.70 per carton



Dacron Spools—4 oz.

Dacron Spools—4 oz. Finest dacron available for the manufacturing of bow strings.

D-138—light weight, 4 oz. spool List \$3.75
D-207—heavy weight 4 oz. spool List \$3.30

Blackhawk Fletching Cement — Typ M for metal shafts. Type W for wood shafts. Tops in fletching cement, unexcelled for glueing feathers and nocks to shafts for the making of arrows (12 to carton).

List Price \$4.20 per carton, \$.35 per tube



Bow String Wax

Blackhawk Bow String Wax—Our own formulated wax. Made from pure beeswax and other ingredients. Unexcelled for synthetic and linen bow strings. (12 cakes to carton)

List Price \$.35 per cake, \$4.20 per carton

Blackhawk Ferrule Cement—Tops in hot melt adhesive. Unexcelled for application of points on arrows and for fishing tackle. 12 sticks to carton.

List Price \$4.20 per carton, \$.35 per stick



Powder Pouch

Blackhawk Powder Pouch—Important item for the archer. Snaps on to the belt, contains powder for smoother release.

List \$1.75

Blackhawk Waterproofing (Aerosol)—Spray dispenser waterproofing for arrows, for fisherman's flies. The finest arrow waterproofing available. Easy to use, economical—just press button, direct to feathers and a fine mist positively waterproofs your arrow. Packed 1 doz. cans to carton.

List Price \$1.25 per can, \$14.00 per carton



Tassel



Arrow Clips.



Fletching Cement



Ferrule Cement



Waterproofing (Aerosol)

BLACK HAWK—WORLD'S FINEST

KWENCHERS



A beautiful plastic canteen, made of pliable plastic, dent proof, noiseless, complete with screw cap and belt clip as shown. Easy to carry and a must for every archer. Indispensable in field, target or hunting and fishing trips. Actually three-way canteens—can be filled with liquid, pre-frozen in your freezer, then used as a cooling device to keep other items refrigerated in your picnic or camping chest. Can be filled with hot beverages and will stay warm for hours. Can be used as a hot water bottle. Indeed, a must for every outdoorsman, every household. Available in forest green.

List Price \$1.98 each



HUSH QUIVER

8th YEAR of proven performance

When you flip an arrow out, it falls into place on the arrow rest.

- Holds four arrows on any bow.
- No screws, clamps or tape.
- Weighs only 1 1/4 oz. per pair.
- Holds any shaft diameter from 9/32" to 11/32".
- For right or left handed archers.

List Price \$2.95 pair

New Economy Model JOSEY SITE

An excellent low-priced sight with spring-loaded elevation adjustment complete with set-screw. Slide-bar windage adjustment. Reversible for left or right bows. Slide recessed for tape. Oblong screw hole for squaring adjustment.



No. JS—Josey Site with standard reticules. \$3.75

BLACK HAWK® SLING-SHOT



A beautiful hunting sling-shot. Hits with the power of a rifle. An ideal, inexpensive weapon for hunting small game such as rabbits and squirrels, or to dispose of vermin. Packed and loaded with excitement and thrills, a must for added gameroom thrills. Sling-shot has reservoir in handle for storage of shot. Pellets released by twisting knob at bottom of handle.

Sling-shot Assembly—packed on red card in plastic container, fully assembled and loaded. List \$1.50 each

Rubber Assembly—2 rubbers and pouch assembled. List \$.25 each

Sling-shot Rubbers. List \$.15 pair
\$.10 each

Pellets List \$.15 pkg. 40 shot

NEW SIGHT 'N LEVEL

Here's the Bow Sight archers have waited for... precise... accurate... simple... rugged... feather weight... plus a Level that detects even the slightest amount of cant. Once Sight is zeroed in for any distance, elevation calibrations are correct for any range. **MASTER CORRECTOR**—if bow-string or arrow fletchings are changed, or temperature varies widely, reset Sight for any single distance and the Master Corrector adjusts all distances automatically. **Look at these features:**

- Spring-loaded elevation adjustment with positive lock set-screw.
- Fine threaded windage adjustment with positive lock set-screw.
- Reversible hood for left- or right-handed shooters.
- Simple as a band-aid to attach... merely strip off backing and press on (no screws).

Saunders SIGHT 'N LEVEL has been tested and approved by a board of expert archer consultants.

No. SSL—Complete Sight and Level in individual box. \$9.95
No. SS—Sight only, without Level, in individual box. \$8.98

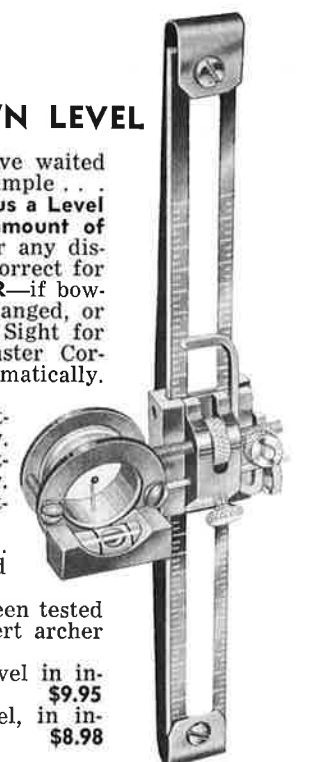

SAUNDER'S LEVEL HOOD

Fits any 3/8" bow sight hood

No. SL—Level only. \$.98



BLACK HAWK ARCHERY ACCESSORIES

RAW MATERIALS, FEATHERS, POINTS, NOCKS, SHAFTS, BOW STRINGS

NOCKS—Made of finest plastic available, designed to eliminate finger pinch. Indexed for ease of nocking correctly. Available in 5 colors—white, yellow, red, green and black.

List Price—
 .45 per doz.
 2.50 per (100)—one color 1 size
 15.00 per (1000) quantities 1000 to 5000—1 size & color per M.
 14.00 per (1000) quantities 5000 to 10,000—1 size & color per M.
 Special prices quoted on request for large users.



Field Parallel Points—Made of finest steel, cadmium plated.
 11/32 I.D.—3/8 O.D.—125 grain
 5/16 I.D.—11/32 O.D.—100 grain
 9/32 I.D.—5/16 O.D.—75 grain
 1/4 I.D.—9/32 O.D.—60 grain
 List Price—
 .75 per doz.
 5.50 per (100) 1 size
 50.00 per (1000) 1 size



Blackhawk points for aluminum arrows—Made of all steel, cadmium plated, knurled for snug fit—no movement.
 List Price—
 1.25 per doz.
 7.00 per (100) 1 size
 60.00 per (1000) 1 size
 Wt. of Point approx. 225 gr.



Target Points—Made of finest steel, cadmium plated.
 11/32 I.D.—3/8 O.D. 60 grain
 5/16 I.D.—11/32 O.D. 45 grain
 9/32 I.D. 5/16 O.D. 30 grain
 1/4 I.D.—9/32 O.D. 30 grain
 List Price—
 .60 per doz.
 4.75 per (100) 1 size
 45.00 per (1000) 1 size

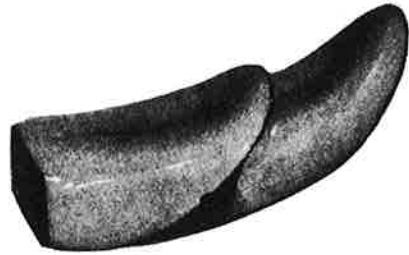

Blackhawk Bow Nock—Made of virgin nylon. For new bows or for repairs.
 Hole size 1/2"x3/16"x1"
 List Price \$1.00 per pair



(FP1) Blackhawk Fish Point—Made of finest steel, head is in three (3) parts — steel ferrule, head and barb. Head screws on to ferrule for easy removal of arrow after shooting fish. Ferrule available to fit shafts from 1/4" to 11/32". Head fits on all ferrules. Cadmium plated.
 List Price—
 \$.50 per point, includes extra barb.

Blackhawk Standard Tapered Field Point—Made of finest steel, cadmium plated.
 11/32 I.D.—3/8 O.D.—
 Approx. 125 grain
 5/16 I.D.—11/32 O.D.—
 Approx. 100 grain
 9/32 I.D.—5/16 O.D.—
 Approx. 75 grain
 1/4 I.D.—9/32 O.D.—
 Approx. 60 grain
 List Price—
 .85 per doz.
 6.00 per (100) 1 size
 57.00 per (1000) 1 size

Port Orford Cedar Arrow Shafts—Select #1 stock—highly finished.
 List Price—
 3.00 per doz.
 22.00 per 100
 Shafts matched for spine.
 Shafts 30" length, colored—3 coats of paint. \$3.50 per doz.
 Shafts with nocks attached—3 coats of paint \$3.50 per doz.
 3 coats of paint. \$4.00 per doz.
 Our choice of color on nocks, colors available for shafts—red, white, yellow and green.

Feathers—Top quality turkey feathers for arrows.
 List Price—
 Grey-barred feathers—
 .90 per doz.—5.50 per (100)
 Dyed Barred feathers—
 1.00 per doz.—7.00 per (100)
 Natural white feathers—
 1.45 per doz.—7.50 per (100)
 Dyed White feathers—
 1.60 per doz.—9.00 per (100)
 Packed in dozen lots or 100 lots—specify wing and color.
 Colors: red, white, green blue, orange and yellow.

Dacron Strings—From 46" to 72"—Double loop, 72" also single loop in increments of 1/2" length. List \$1.35
 Childrens Hemp Strings—4'-0", 5'-0" and 6'-0". List \$3.35
 Woven Dacron Strings—50" only to 40#. List \$1.00



Black Hawk Standard Tapered Bunt—Made of finest steel, cadmium plated.
 11/32 I.D.—3/8 O.D.—
 Approx. 125 grain
 5/16 I.D.—11/32 O.D.—
 Approx. 100 grain
 9/32 I.D.—5/16 O.D.—
 Approx. 75 grain
 1/4 I.D.—9/32 O.D.—
 List Price—
 .85 per doz.
 6.00 per (100) 1 size
 57.00 per (1000) 1 size



FLU-FLY
 MAKE YOUR ORDINARY ARROWS FLU-FLY'S IN MINUTES

3 for \$1.00
 ... and use
Flu-Fly's for Fishing Arrow Fletching!
 Resembling a badminton bird flu-fly slips onto an ordinary arrow shaft and slides up to the feathers. Head snugs shaft. Cone is temperature compensated poly-vinyl—always stays soft. Convenient. Saves cost of flu-fly's.
No. FF—Display box of 12 (3 for \$1 seller) \$4.00



Stops Small Game Cold... Minimizes Arrow Damage!
BLUDGEON

BLUNT ARROWHEAD for Rabbits, Squirrels, Birds and other small game

A Saunders exclusive—a killing head that minimizes arrow shaft breakage. On hitting rock or tree, point "gives" and glances off, leaving shaft undamaged. Made of temperature compensated rubbery plastic... won't get brittle in the coldest weather. Tremendous impact of 6-pointed, 7/8" head kills small game instantly by shock. Fits 5/16" or 11/32" shaft. Bright red color makes hunting arrows easier to find.
No. NB10—Bag of 10 Bludgeons. \$1.98

CUT OFF HERE

Use this convenient Order Form (over)

Use this convenient Order Form (over)

HUNTING POINTS



High Precision — 3-blade, one-piece, welded hunting point. Available in 2 sizes: 5/16" @ 100 grain; 11/32" @ 125 grain. List **\$3.75** per doz.



Bodkin—3-blade. Available in 2 sizes; 5/16"; @ 100 grain; 11/32" @ 125 grain. List **\$3.75** per doz.



MA3—3-blade point. Available in 5/16" @ 100 grain; 11/32" @ 115 grain. List **\$3.75** per doz.



CB2—2-blade. Available in 1/4", 9/32", 11/32". List **\$3.00** per doz.



2-Blade Arrowmate. Blade 3" long, razor edged. Edges curved for deeper cutting action. Spring steel—tough plastic ferrule. Sizes 5/16" and 11/32". List **\$3.75** per doz.



3-Blade Arrowmate. Razor sharp—powerful penetration—non-curl point—micro molded ferrule. A powerful, rugged, beautiful point. Sizes 5/16" and 11/32". List **\$4.95** per doz.



4-Blade Arrowmate. Main blade 3" long, razor sharp edges—tough plastic ferrules. Spring steel—four cutting edges. Sizes 5/16" and 11/32". List **\$4.50** per doz.



Rubber Suction Cup Vacuum Points. For rebuilding old arrows into safe children's arrows or for new children's arrows. List **\$3.35** per doz.

BLACKHAWK FEATHER REST. Protect your bow—increase your score—use Blackhawk feather rest—easily applied—pressure sensitive back-pull and press into position. List **\$0.50**



INDEX

| | Page | | Page |
|---|------|--|--------|
| Vital Information | 2 | Target Faces and Target Mats | 12 |
| Bows—Chief, Chief Scout, Hornet Special | 3 | Women's Leather Quivers and Accessories | 13 |
| Bows—Short Hornet, Warrior | 4 | Men's Quivers and Accessories | 14 |
| Bows—Bee, Yellow Jacket | 5 | Children's Quivers and Accessories | 15 |
| Bows—Scorpion, Mosquito | 6 | Armguards, Gloves | 16 |
| Archery Sets | 7 | Archery Accessories | 17, 18 |
| Bow Fishing and Accessories | 8 | Kwenchers, Slingshots, Bow Quivers, Sights | 19 |
| Aluminum Arrows | 9 | Bow Strings, Points, Nocks, Feathers | 20 |
| Top Grade P.O.C. Arrows | 9 | Order Forms | 21, 22 |
| Wood Arrows and Rack Arrows | 10 | Merchandise, Rocketeer Hunting Point | 23 |
| Glass Arrows | 11 | Hunting Points, Feather Rests | 24 |