

Important notes for this presentation:

At the end of the presentation are four slides (#'s 63-66) explaining how to use simple math to calculate the speed of the cars, given a few parameters, like the motor speed, wheel diameter, and gear ratio.

The star and circle symbols are hyperlinks to the appropriate slides, Use the blue star (slide 50) to go to the animation, then the red star to return to slide 50.

Complete clicking on slide 50, then, when finished, click the green circle to go to slide 52.



“HERE COMES THE SUN”

A STUDY OF ENERGY, ELECTRICITY AND *PHOTOVOLTAICS/SOLAR CELLS*



Institute Of Electrical And Electronic Engineers, Phoenix Section

Teacher In Service Program / Engineers In The Classroom (TISP/EIC)

“Helping Students Transfer What Is Learned In The Classroom To The World Beyond”

Research Sources

This presentation includes material from the following web sites:

HowStuffWorks: “How Solar Cells Work,”

<http://http://science.howstuffworks.com/environmental/energy/solar-cell.htm>

Explain that stuff! “Solar Cells”

<http://www.explainthatstuff.com/solarcells.html>

Wikipedia, http://en.wikipedia.org/wiki/Solar_cell

Tennessee Valley Authority, Coal-Fired Power Plant,

<http://www.tva.gov/power/coalart.htm>

The Electricity Book,

http://www.bgfl.org/bgfl/custom/resources_ftp/client_ftp/ks2/science/electricity_book1/index.htm

Our Sponsors

- The AZ Science Lab is supported through very generous donations from corporations, non-profit organizations, and individual donations.
- Our sponsors include:



Workshop Objectives

- Learn what an engineer does
- Discuss the Sun as a great energy source
- Investigate solar cells and their uses
- Learn a bit about electricity
- Engineer and build a solar car
- Have fun while learning!!!

The Solar Model Car You Will Build

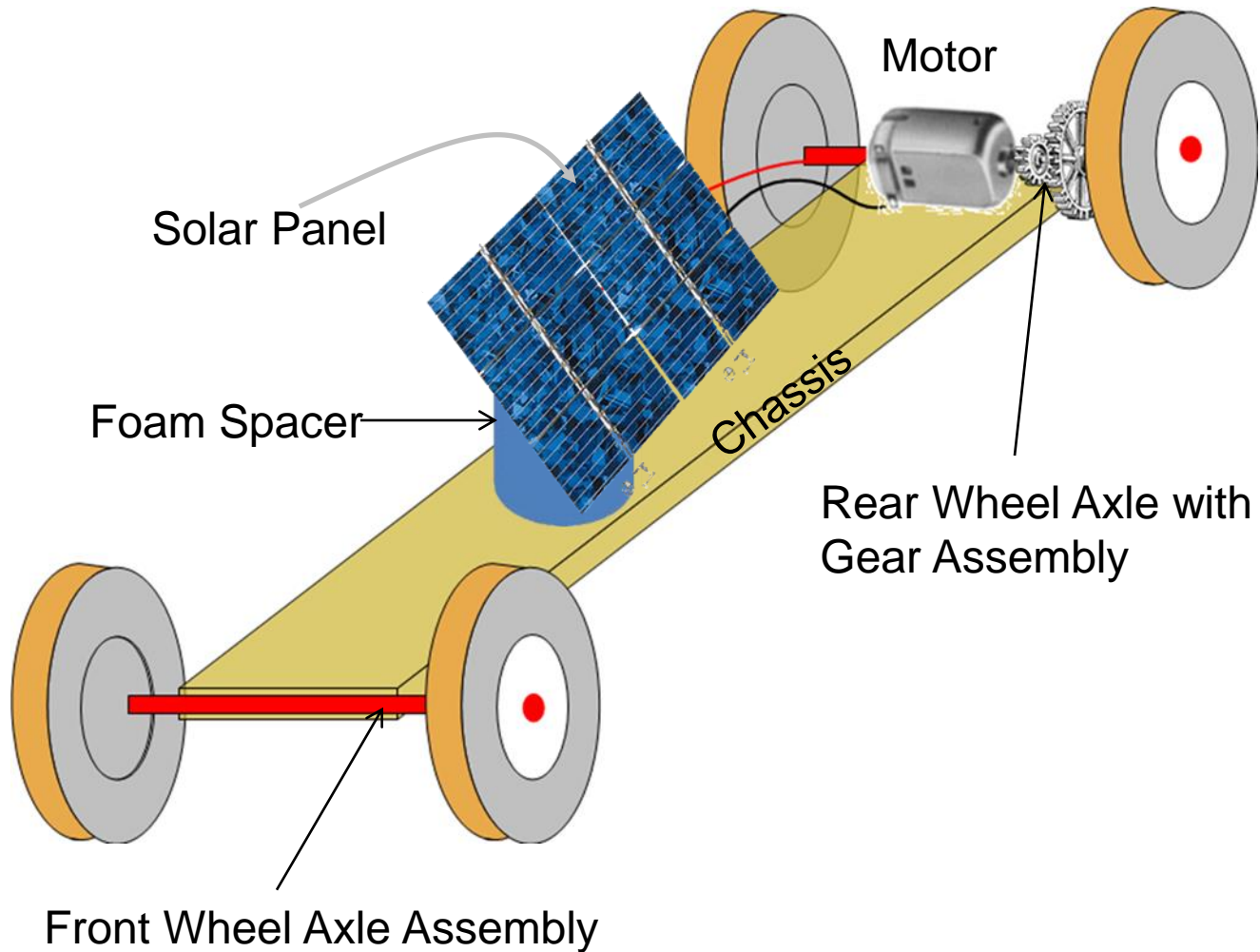



ENERGY

What is it?

Energy is the ability to do **work.**

Can you name some common forms of energy?

TYPES OF ENERGY

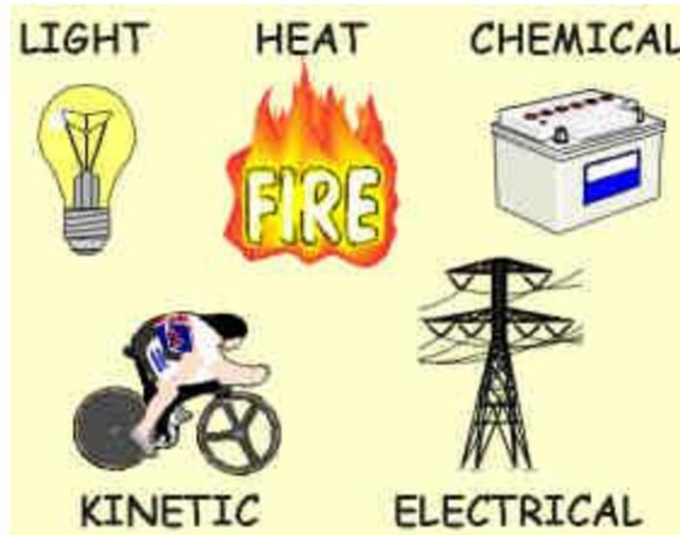



Properties of Energy

The Law of the Conservation of Energy

- ***Energy can be neither created nor destroyed, but can change form.***

Energy forms can be converted –

- Chemical to mechanical: car engine
- Potential (gravity) to kinetic: roller coaster
- Chemical to light/heat: burn a candle

What is the only* source
of energy on earth?

* Except nuclear



The Sun

**Our energy source –
past, present, and future!**



What Is The Sun?

The **Sun** is the **STAR** at the center of our Solar System

The Sun has a diameter of about 1,392,000 kilometers (865,000 mi).

By itself accounts for about 99.86% of the Solar System's **mass**

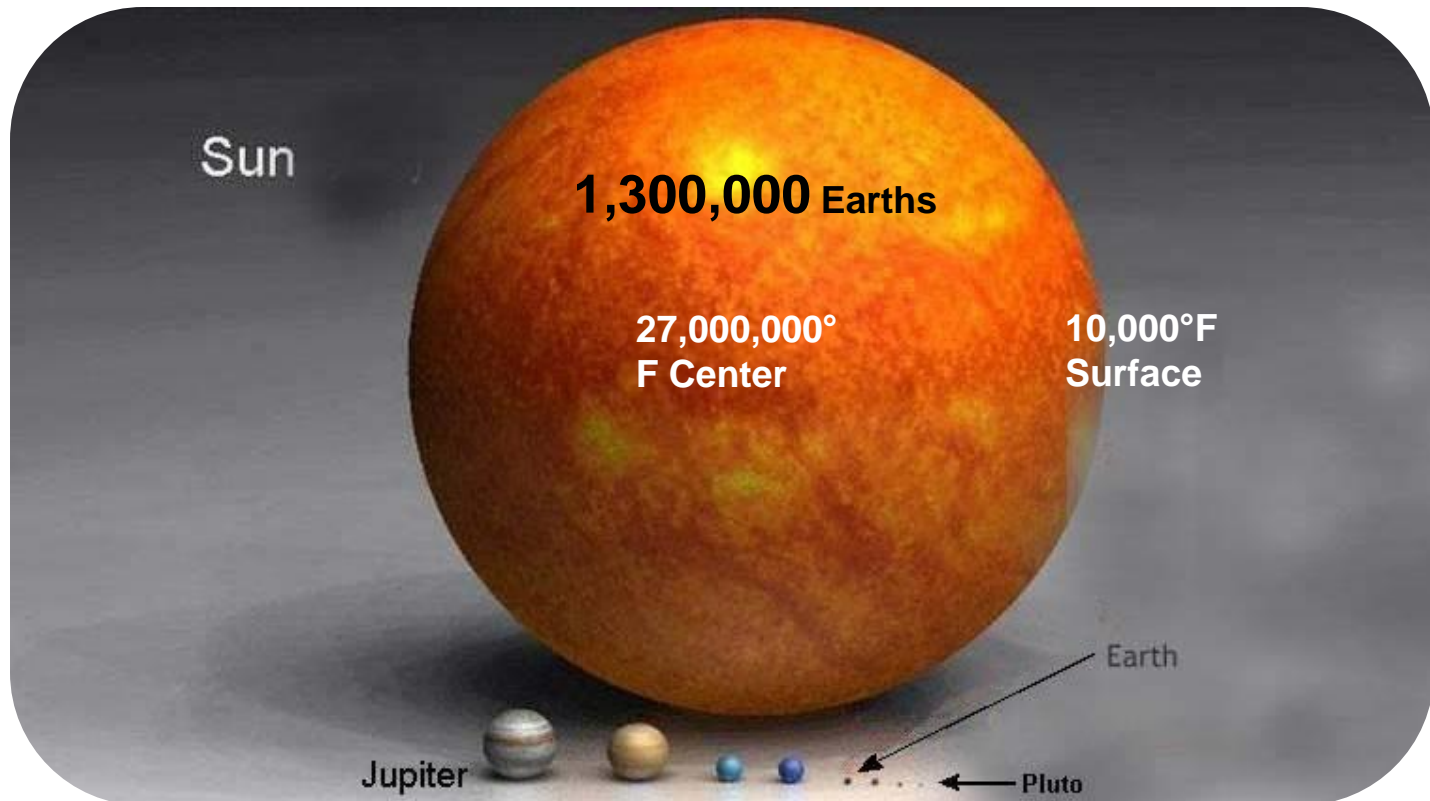

Coal, peat, oil and gas are all major sources of energy for us...where did the energy needed to form these fuels come from? You guessed - it came from the Sun!



Solar Energy From 400 Million Years Ago

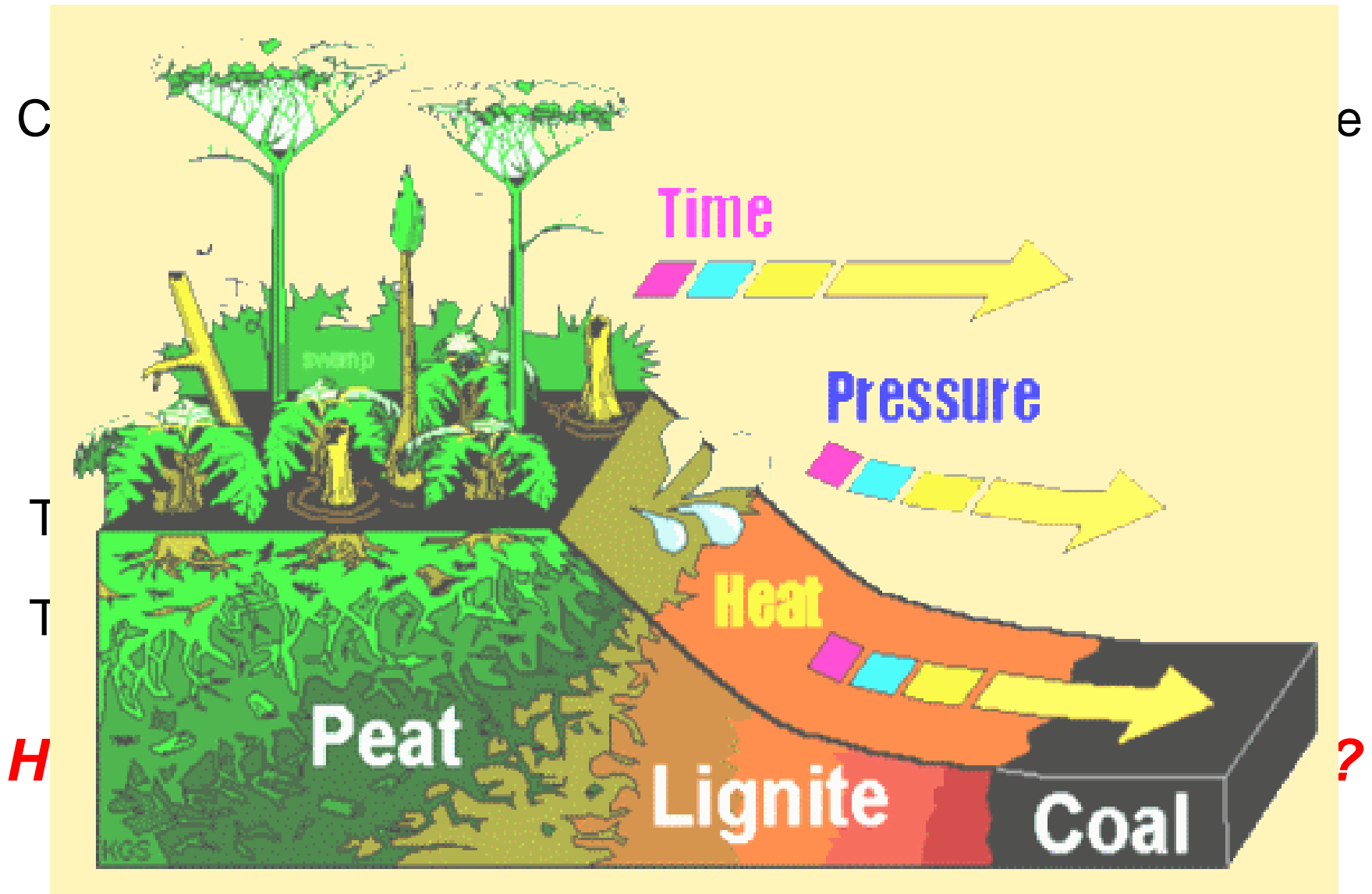

Forms of Energy

Chemical



Wind



ELECTRICITY

Water



Solar



Electricity: How Do We Make It?

- It is a conversion from other forms of energy:
 - Chemical energy into electricity:
batteries
 - Mechanical energy into electricity:
electric generators
 - Light energy into electricity:
solar panels (photovoltaic effect)



Electricity: How Do We Make It?

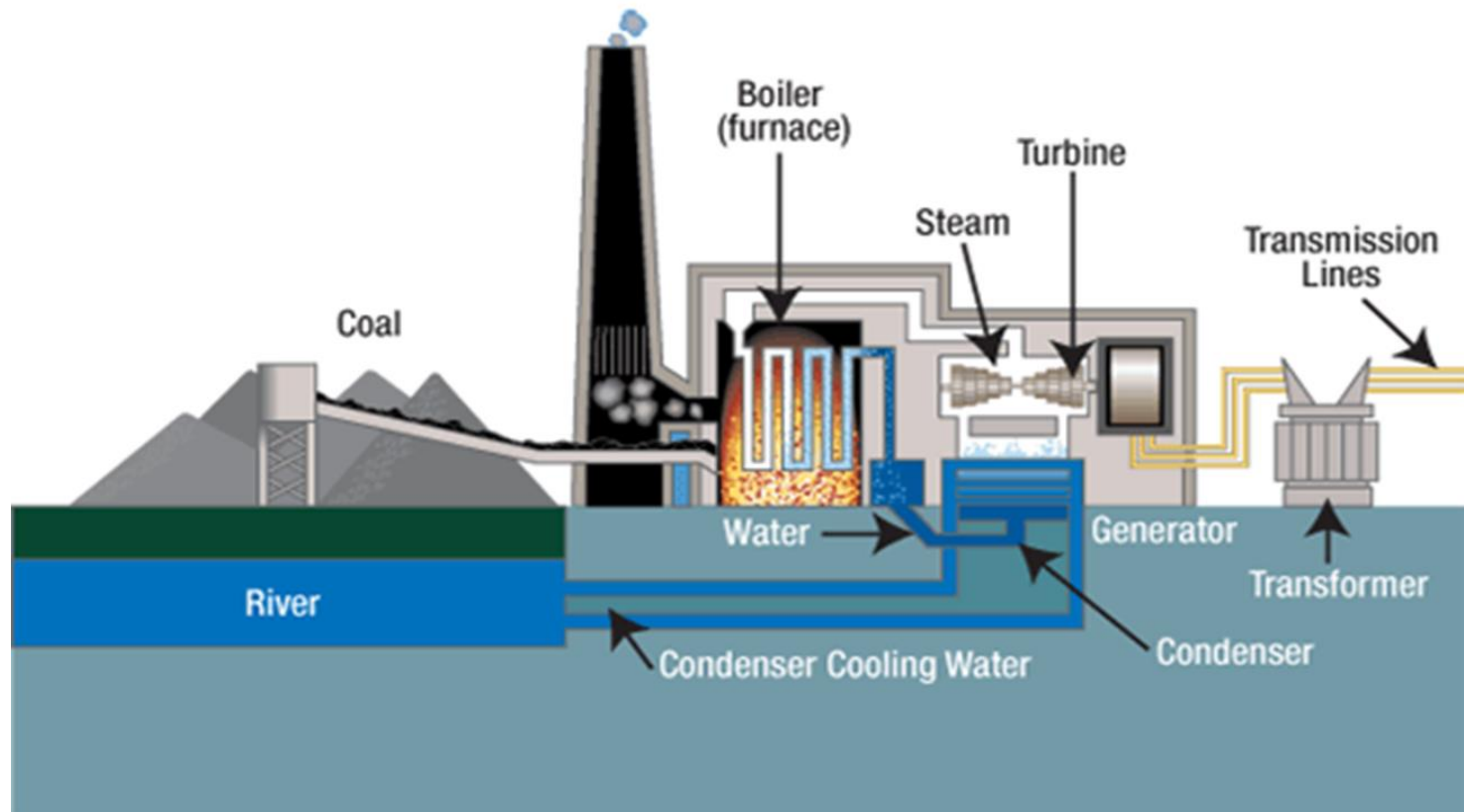

It is a conversion from other forms of energy –

- Chemical energy into heat energy (burn coal, oil, natural gas)
- Heat energy into mechanical energy (turn turbine)
- Mechanical energy into electricity (turn electric generator)

A CLEANER WAY TO PRODUCE ELECTRICITY

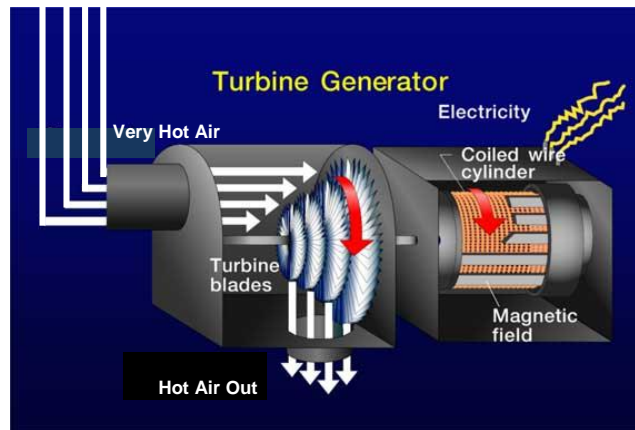
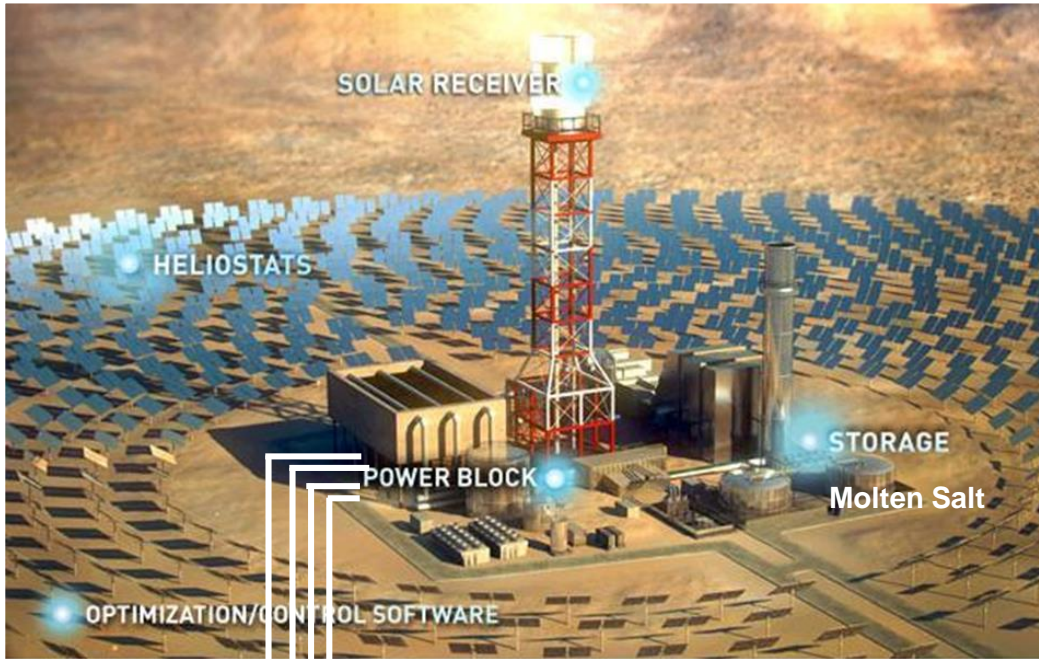

AC OUT



A SIMPLE WAY TO PRODUCE ELECTRICITY



No Turbines/Generators!

The Problem with Electricity

Electricity is a form of energy that is very hard to store, but we can convert it to chemical energy in a battery, and then re-convert it back to electricity!

*Energy can be neither created nor destroyed, **but can change form.***

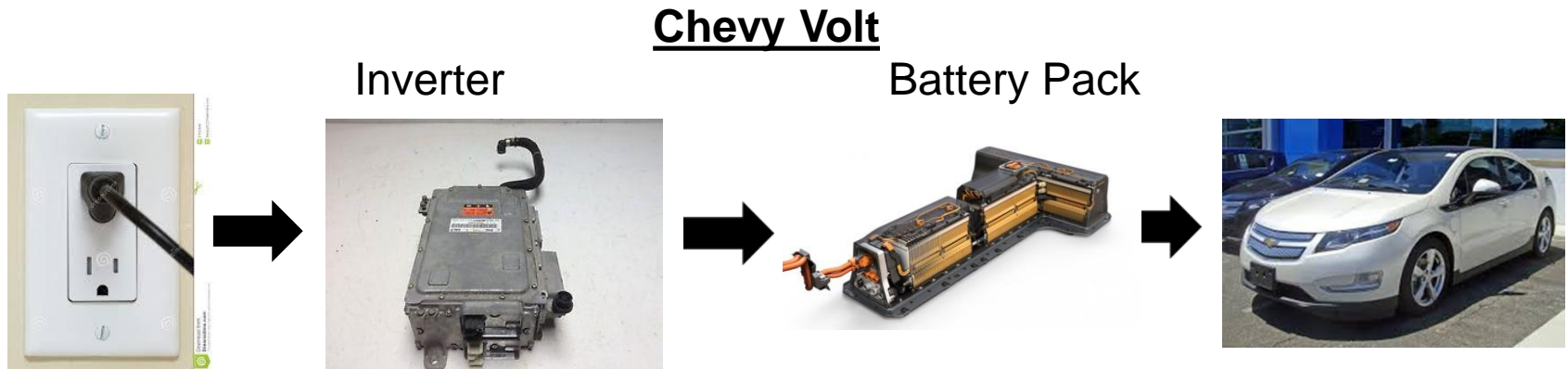

Electric Cars

Chevrolet Volt



Nissan Leaf



Tesla Model S



Solar Power and Houses



Residential Solar System

Let's Look at a Home Solar System!



What Is Electricity And What Are It's Properties?

Two Forms:

1. Static Electricity



2. Current Electricity

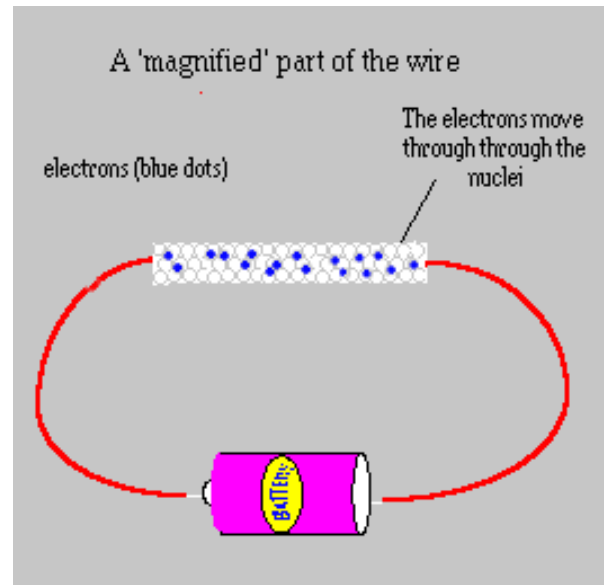



What Is Electricity And What Are It's Properties?

Electricity is the flow of *electrons*

The movement of free electrons forms an *electric current*

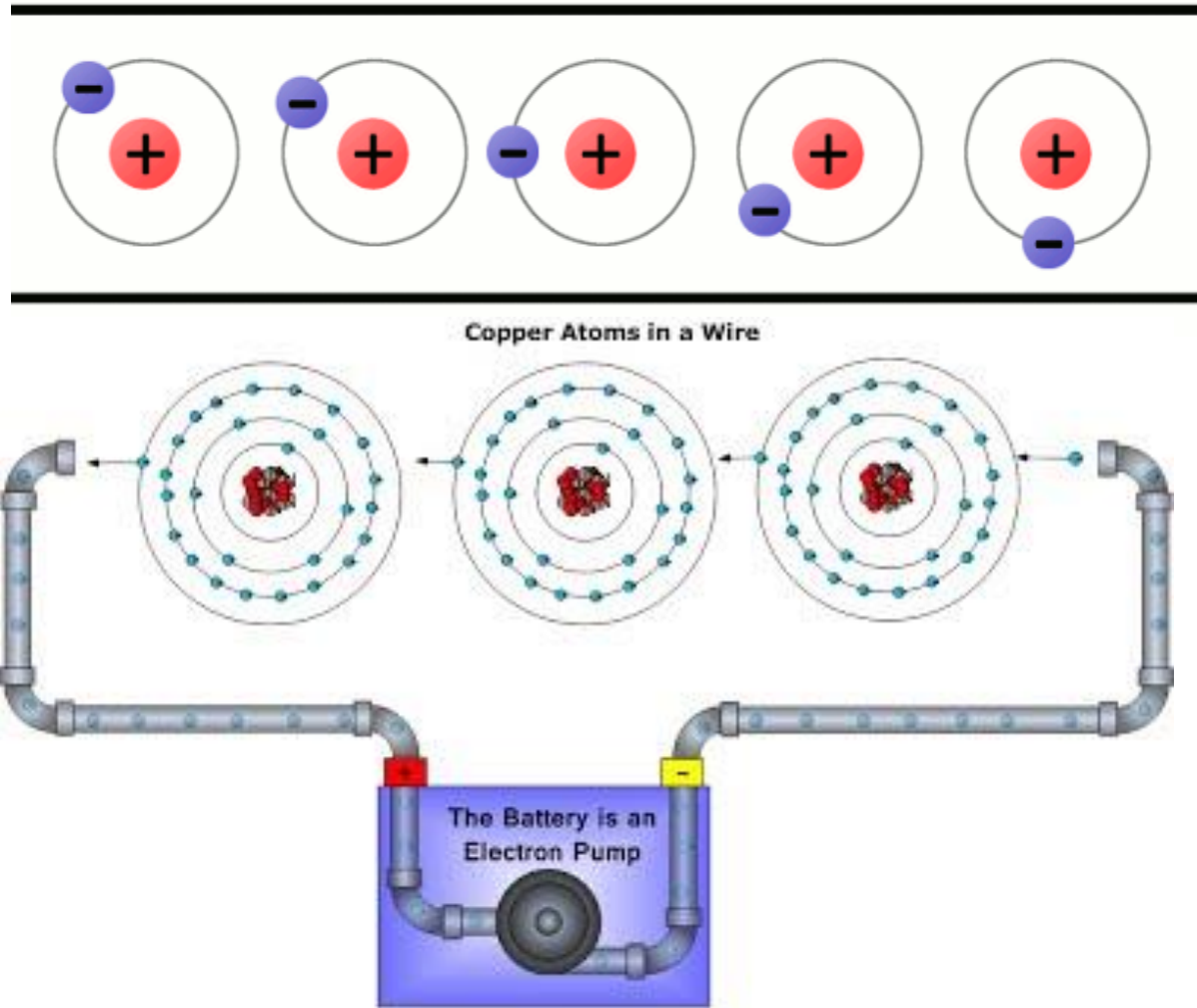
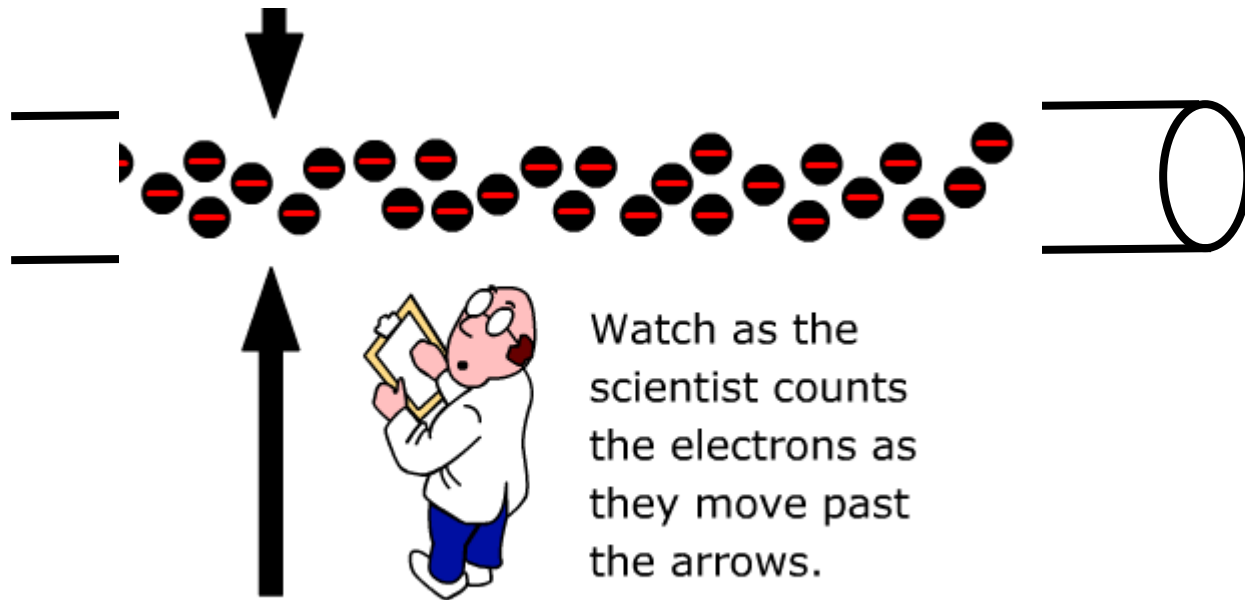

Figure 3

An *Electric Circuit* is a path through which electricity flows



How do we measure electricity?



Billions and billions per second

Characteristics of electric flow:

Amperage – quantity (amount) of electricity flowing

Voltage – pressure (push force) of the electricity

Watts – Power of the electricity: $W = A * V$

We measure electricity using a calibrated meter

- An electric multimeter (voltmeter, ammeter):





Electrical Nature of Matter

Materials that permit the motion of free electrons are called **Conductors**.

Materials that oppose the motion of electrons are called **Insulators**

Conductors are said to have **low resistance** while **insulators** have high **resistance**

CONDUCTORS

Silver
Copper
Gold
Aluminum
Brass
Zinc
Iron

INSULATORS

Dry Air
Glass
Mica
Rubber
Asbestos
Bakelite
PVC
Teflon
Plastics

Non Connected Electrical Circuit

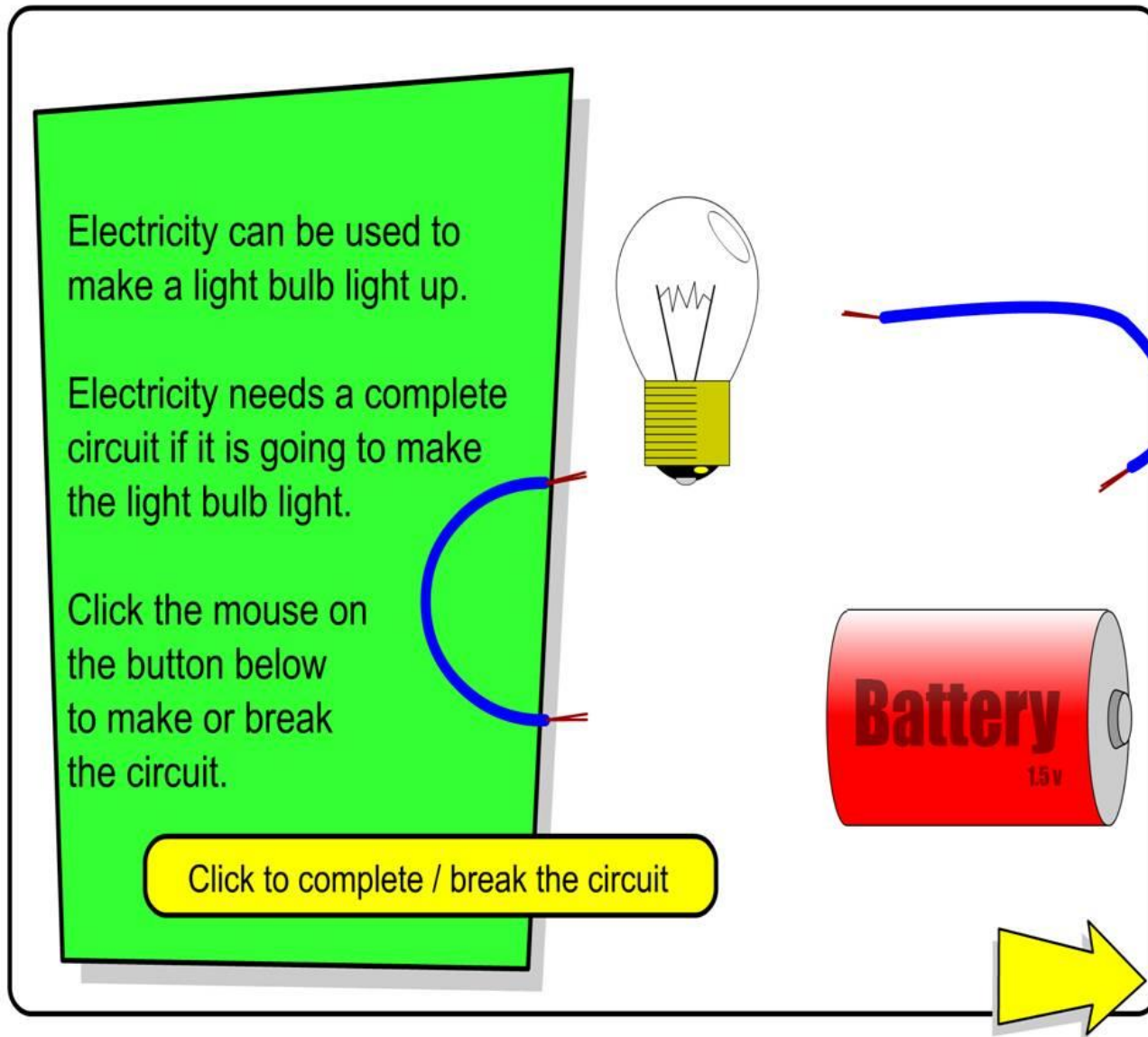

Connected Electrical Circuit

Electricity can be used to make a light bulb light up.

Electricity needs a complete circuit if it is going to make the light bulb light.

Click the mouse on the button below to make or break the circuit.

Click to complete / break the circuit

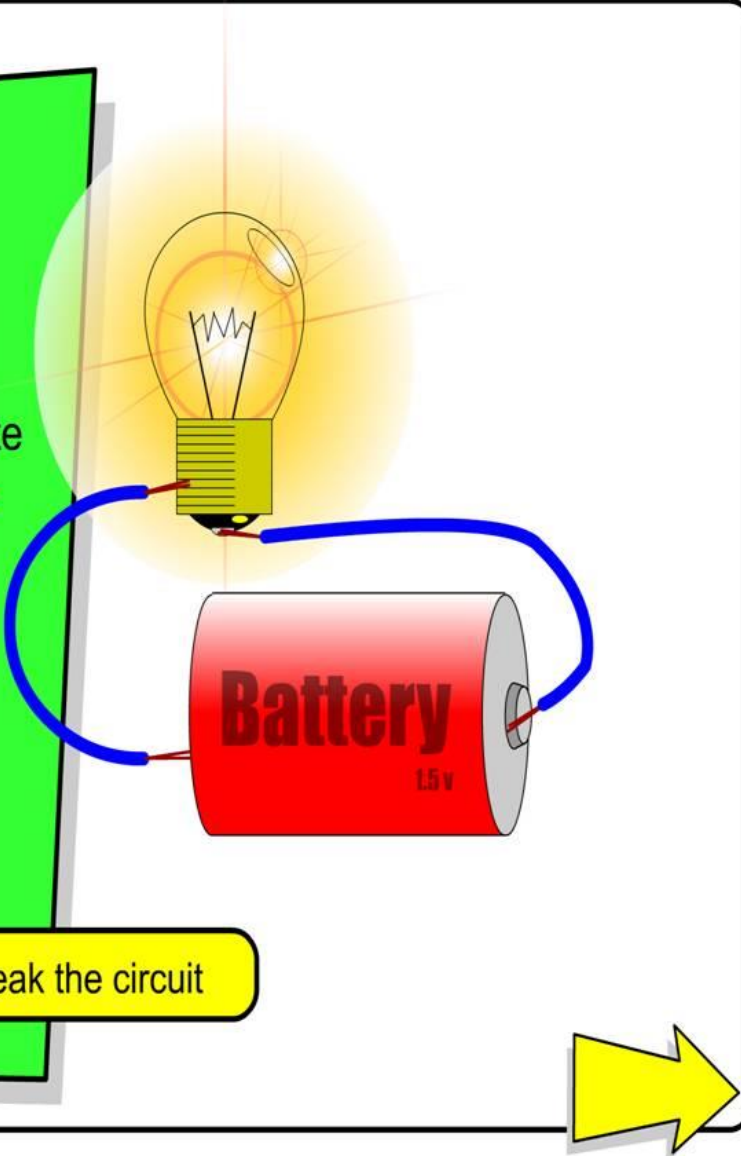

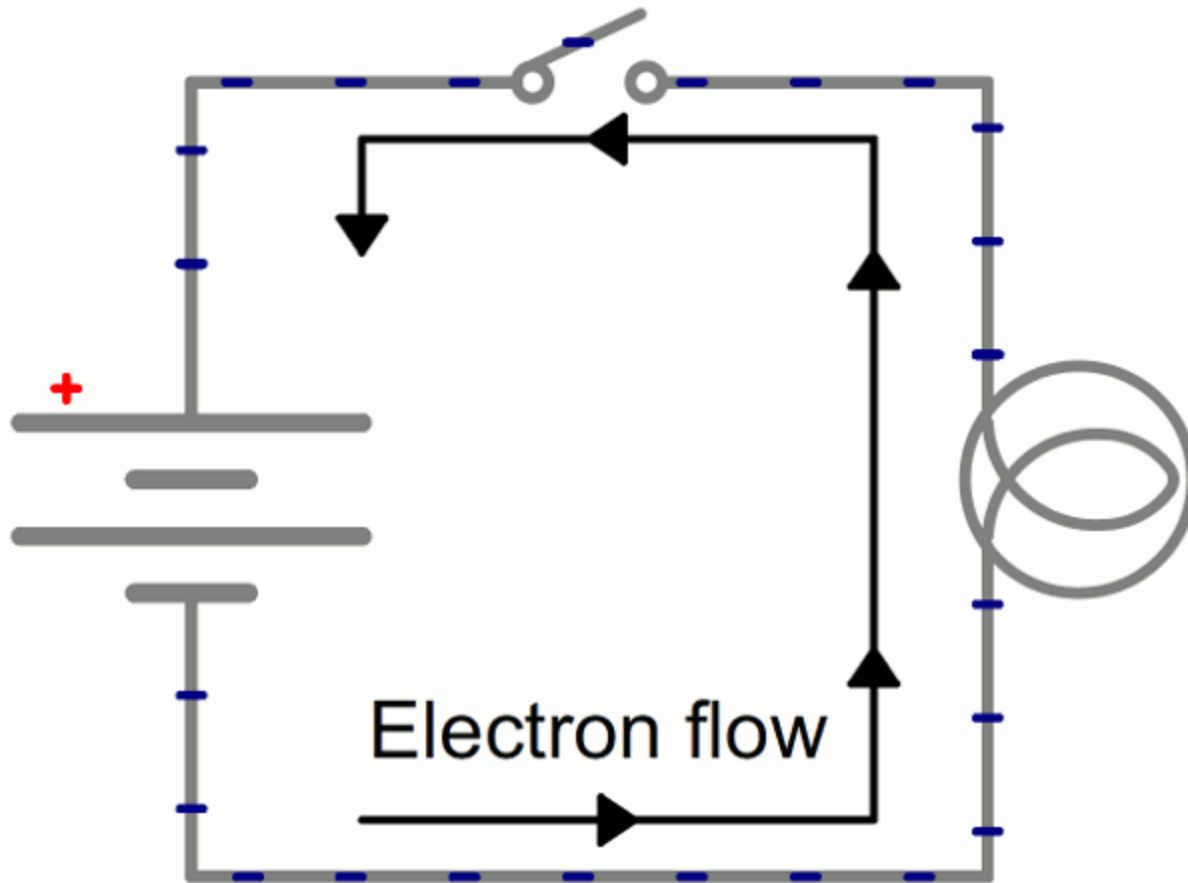

How to connect circuits

Connecting *Loads (resistors)*

Series Circuit

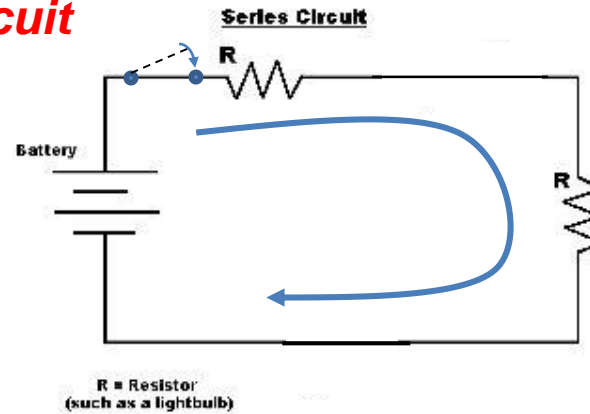
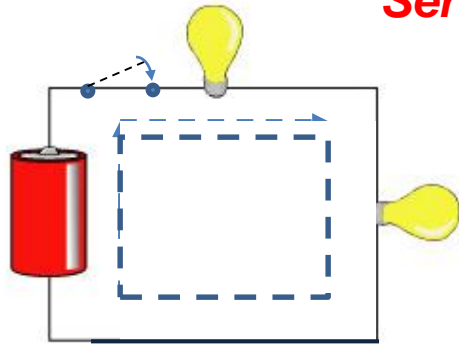

How to connect circuits

Connecting *Loads (resistors)*

Parallel Circuit

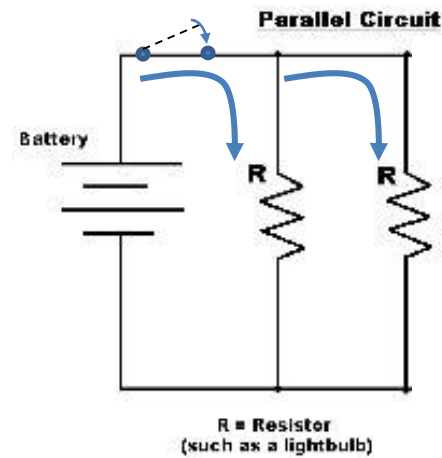
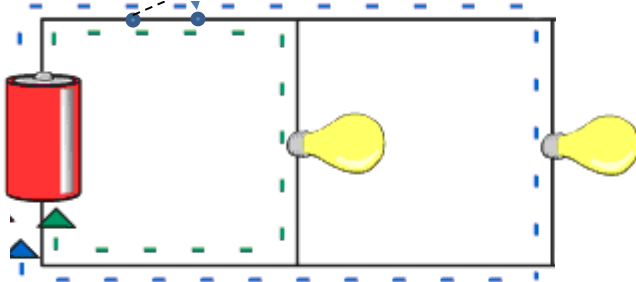



How to connect circuits

Connecting *Loads (resistors)*

Series Circuit

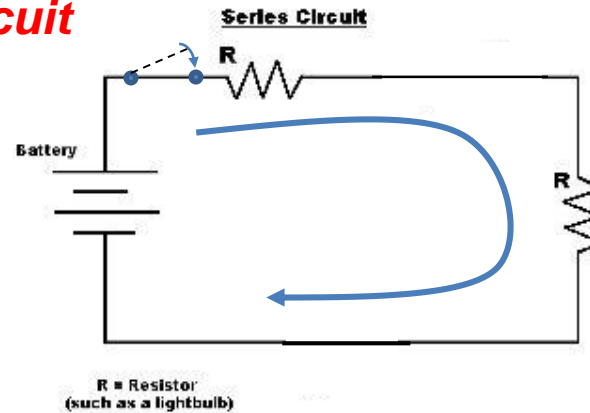
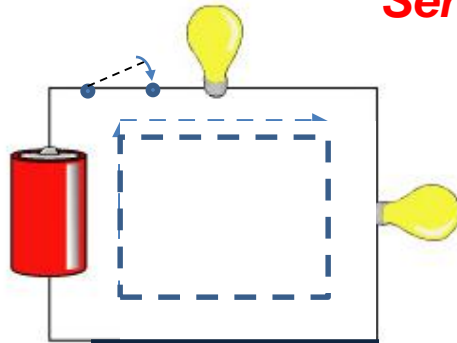

Parallel Circuit

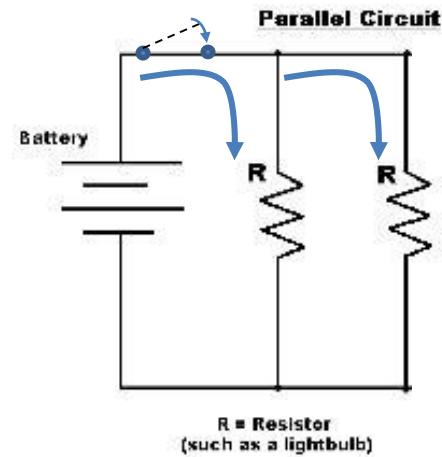
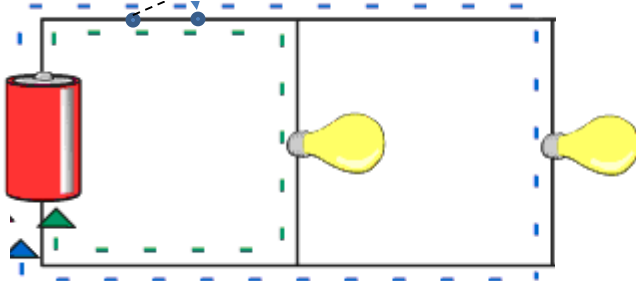

Circuits

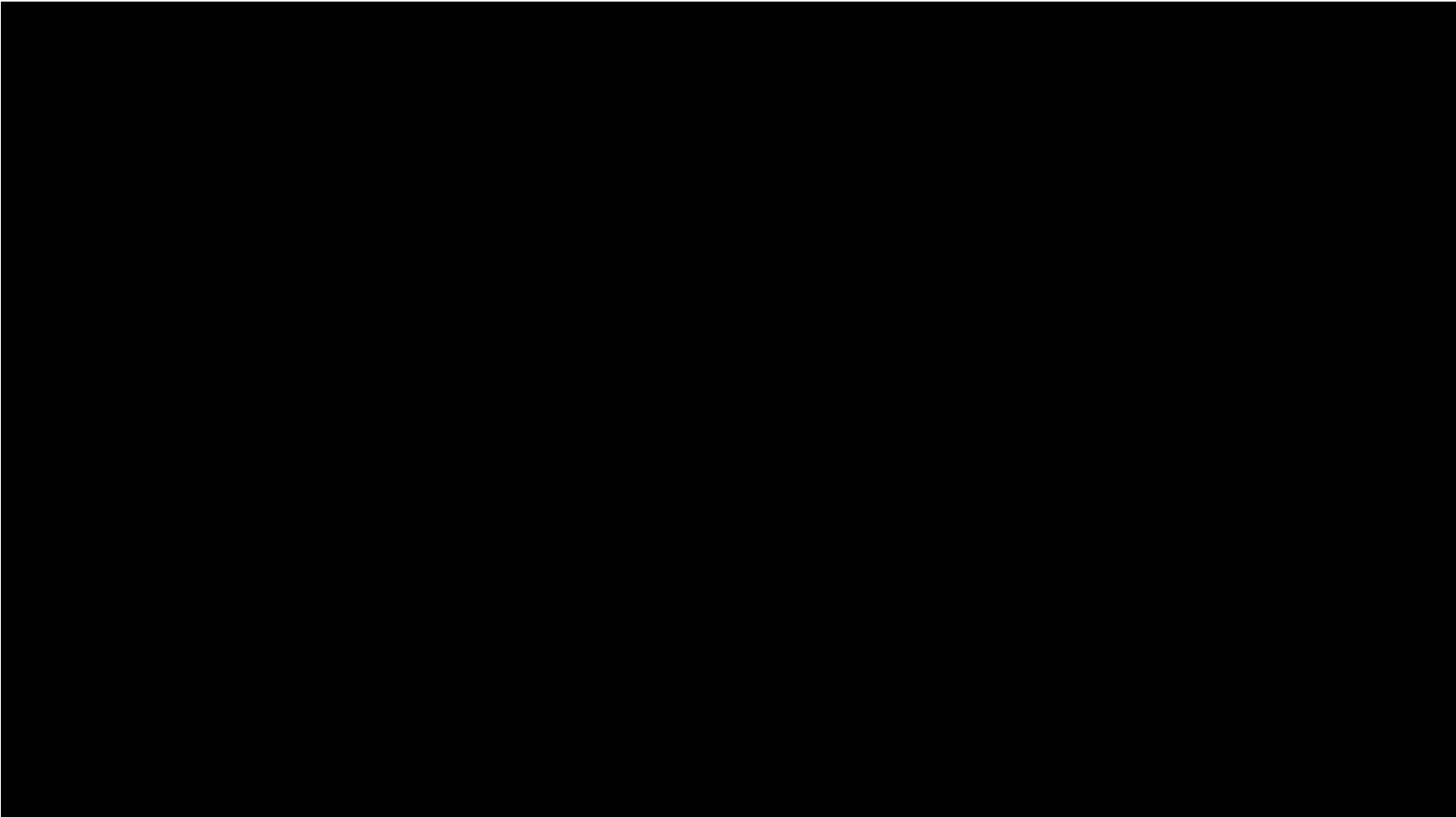

How to connect circuits

Connecting *Sources* (batteries)

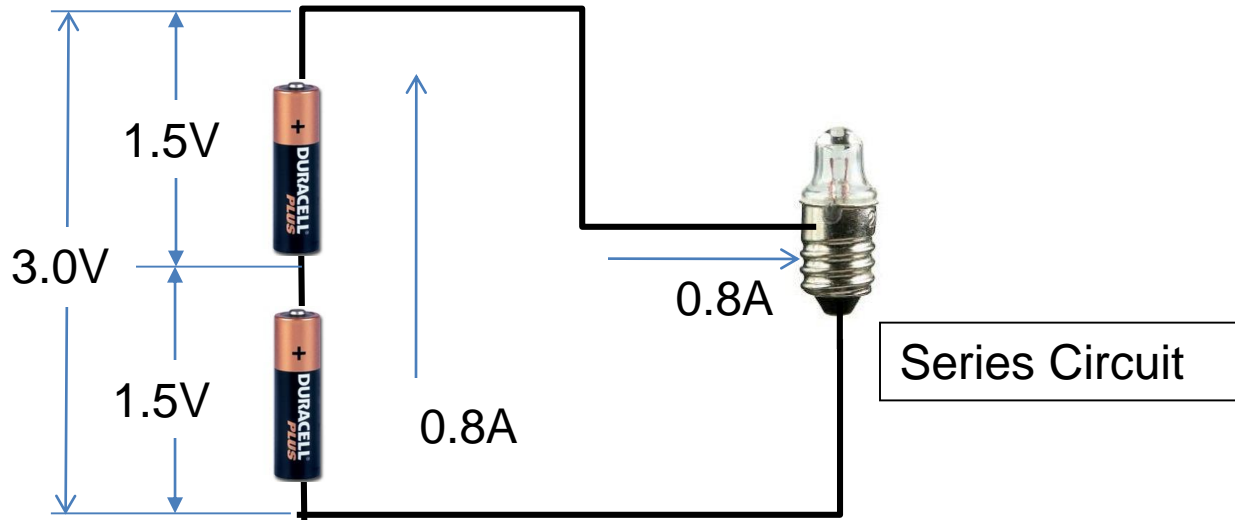

Power = Voltage × Current

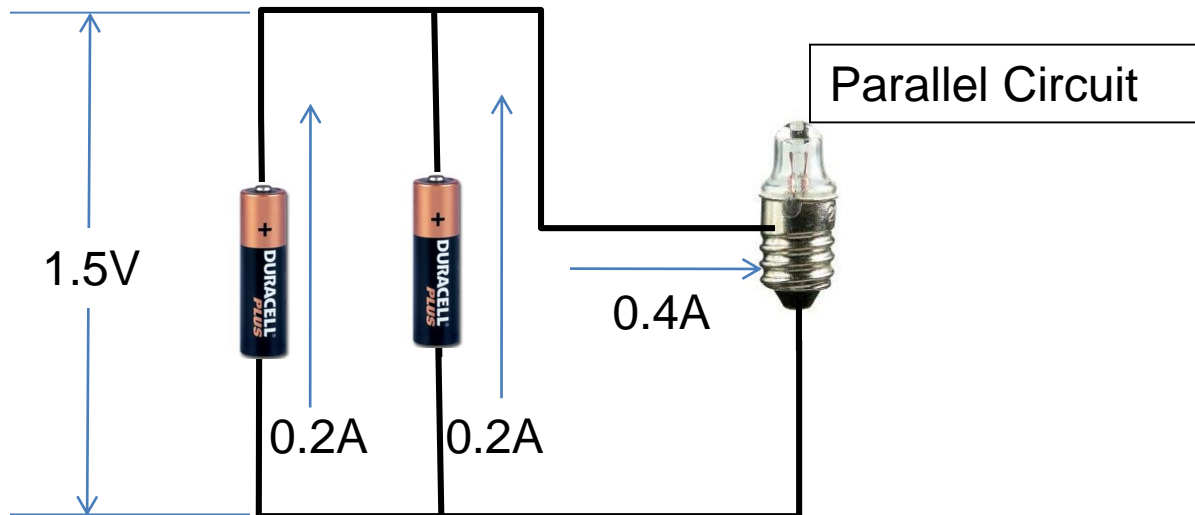



Applying the Series/Parallel Concept to the Solar Car

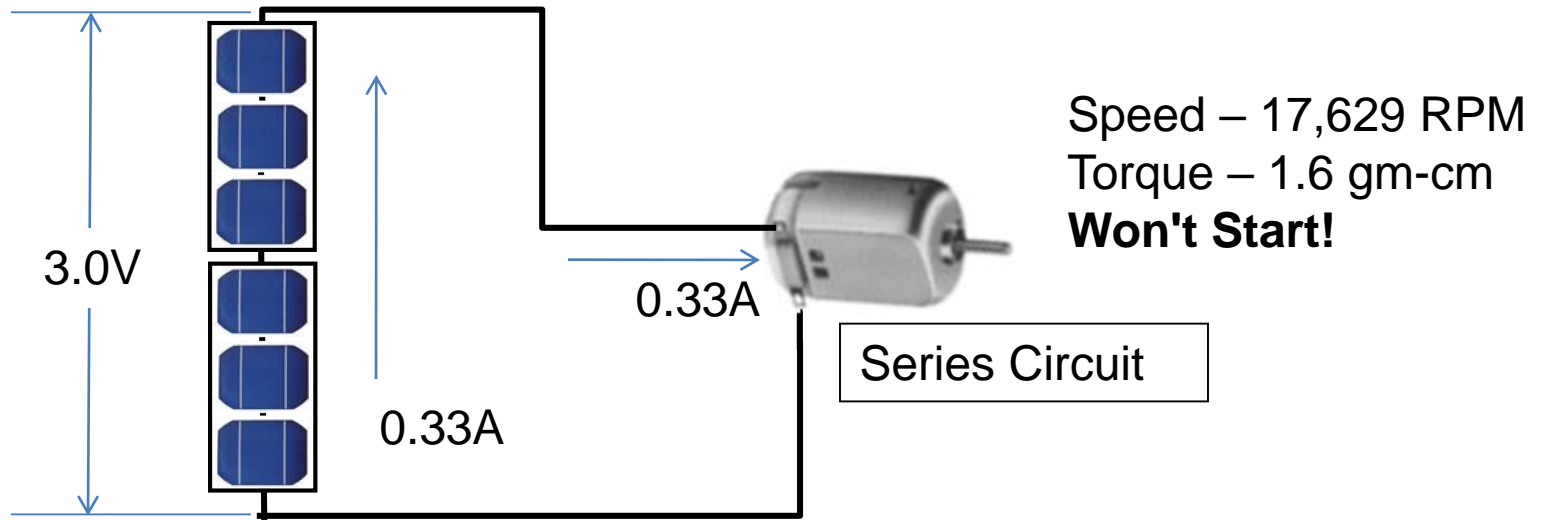

Power = Voltage × Current

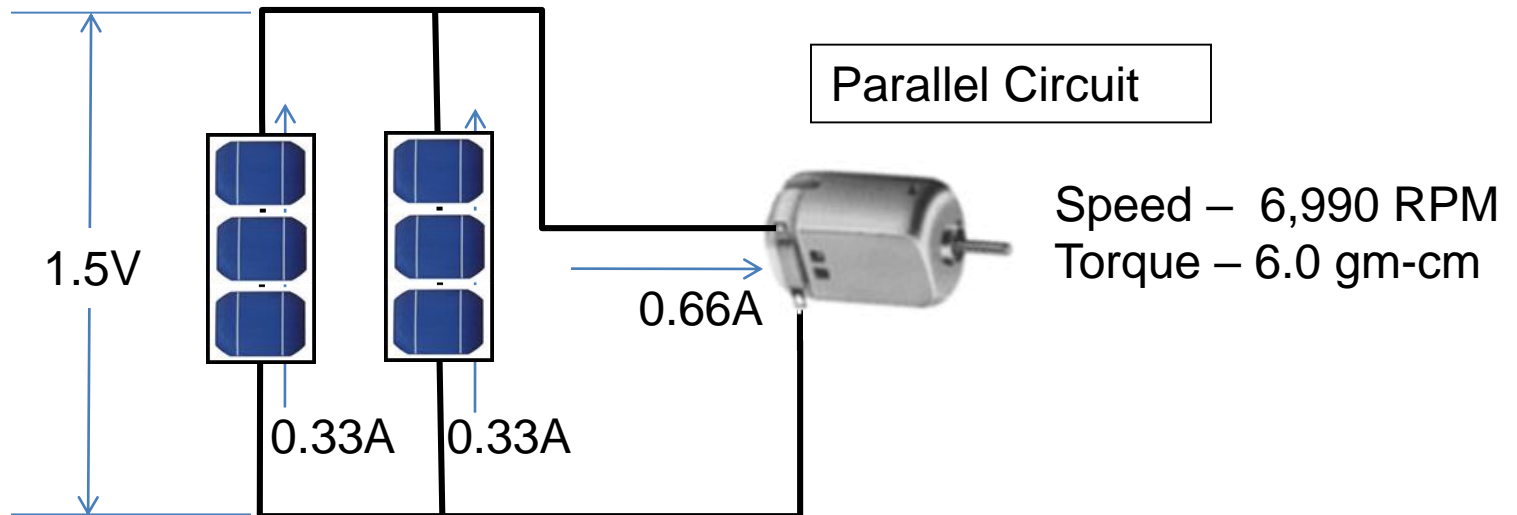

Creating and Connecting Circuits

Using a Breadboard

Name:

Circuits Worksheet

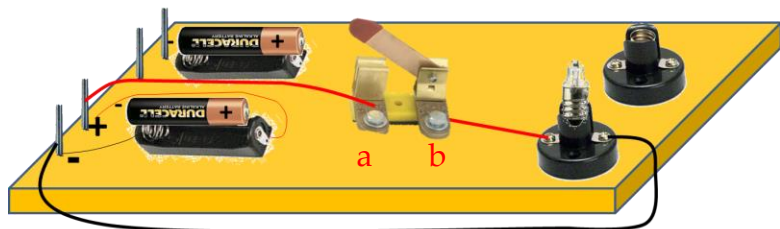

1 Battery,
1 light bulb

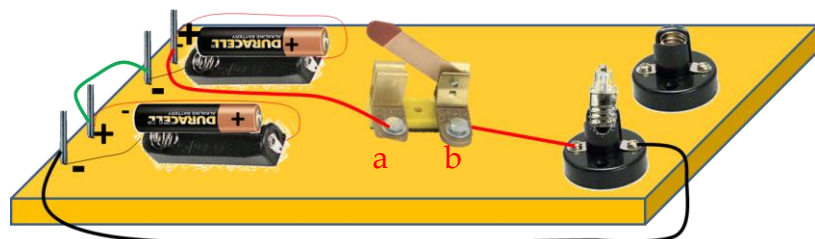
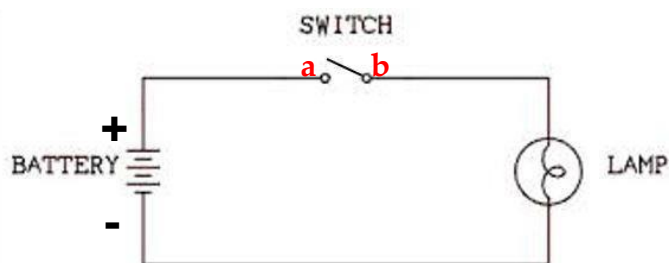

2 Batteries
in series,
1 light bulb

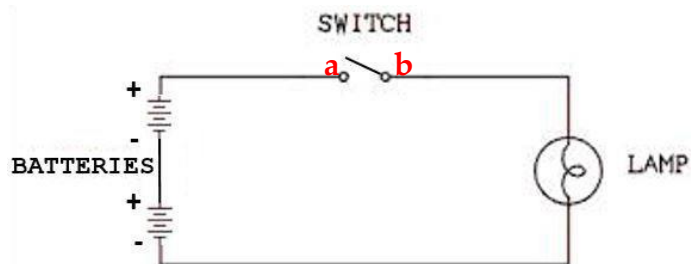

1 Battery, 1 Lightbulb

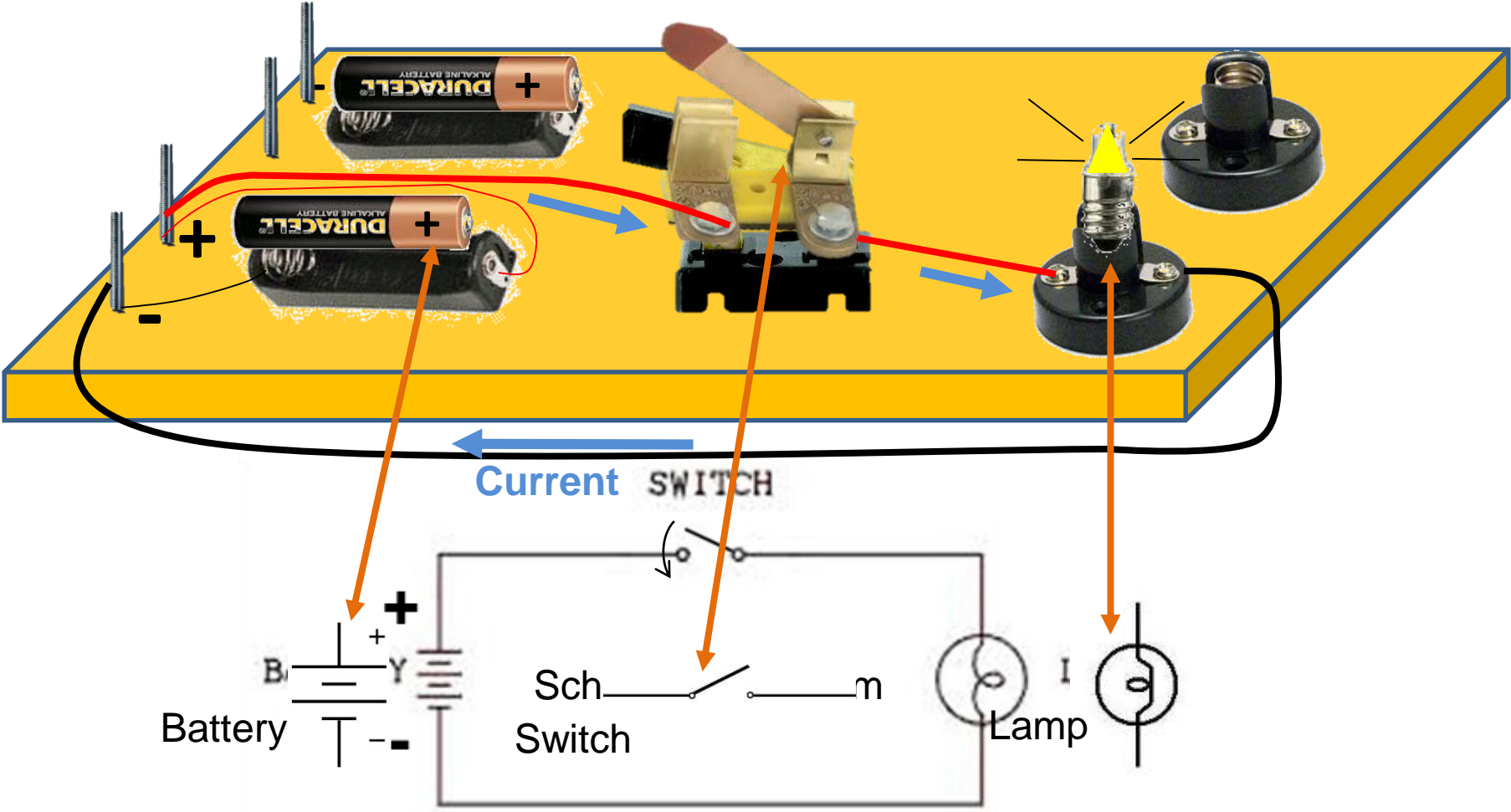

2 Batteries, 1 Lightbulb

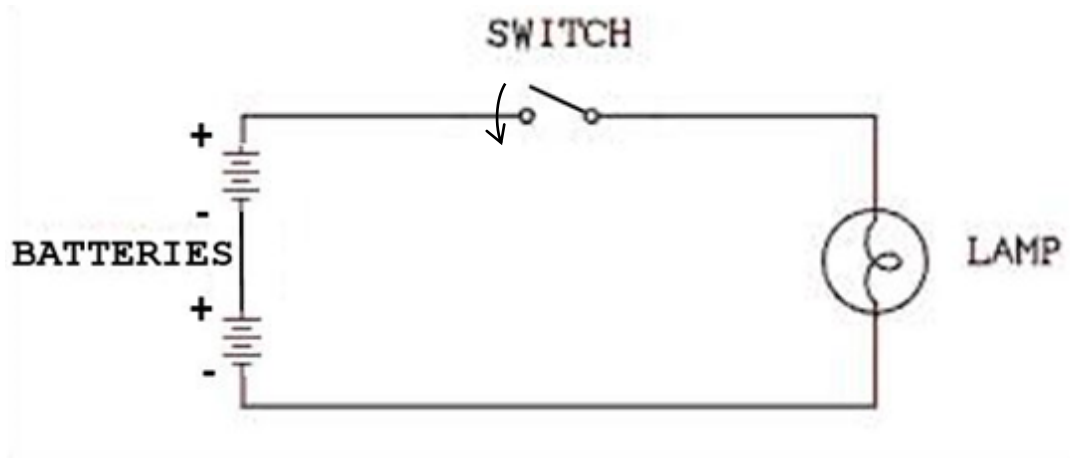
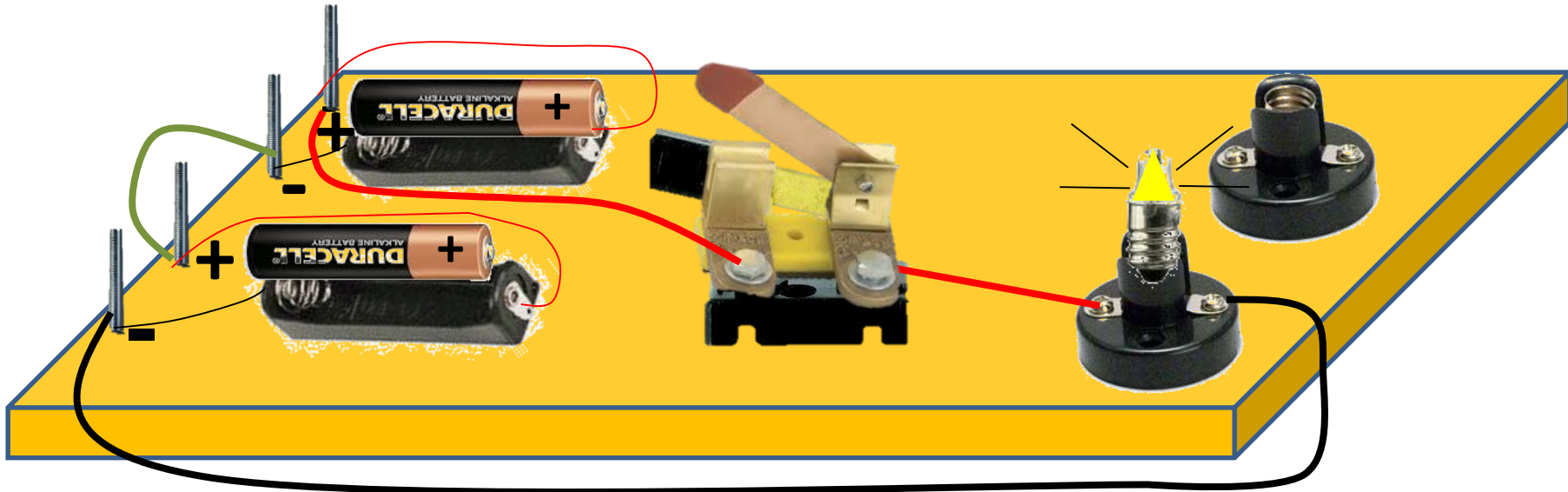

Types of Electricity

Alternating Current - AC



Direct Current - DC

Batteries



Dry Cells



Wet Cells



Solar Cells

Direct Current Sources

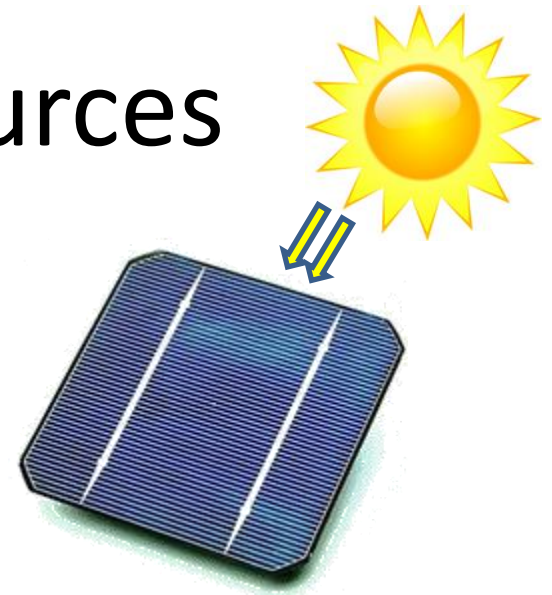
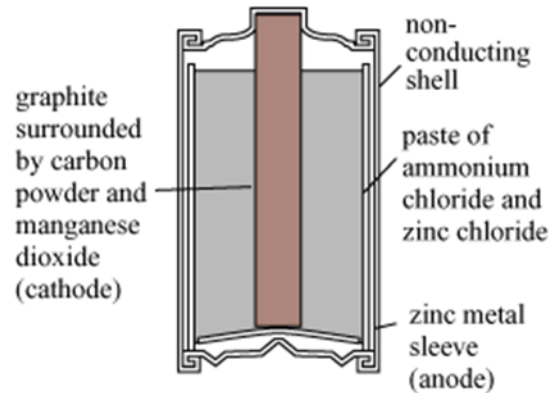

Batteries produce Direct Current (DC)

Batteries produce electricity from a chemical reaction.

Solar Cells produce electricity directly from light!



What Is A Solar Cell?



It converts the energy of sunlight directly into electricity
A Solar Cell is also known as a Photovoltaic (PV) Cell

“**Photovoltaic**” – combination of 2 Greek words
Photo \equiv Light
Voltaic \equiv Electric or Voltage

How Do Solar Cells Work?

1. When sunlight shines on the cell, **photons** (light particles) bombard the upper surface.
2. The **photons** carry their energy down through the cell.
3. The photons give up their energy to **electrons** in the lower, **p-type** layer.
4. The **electrons** use this energy to jump across the barrier into the upper, **n-type** layer and escape out into the circuit.
5. Flowing around the circuit, the electrons make the lamp light up.

Two layers of “doped” silicon material sandwiched together:

Other elements are added to silicon so that:

- N-type material has excess of electrons
- P-type material has “holes”, deficient in electrons.

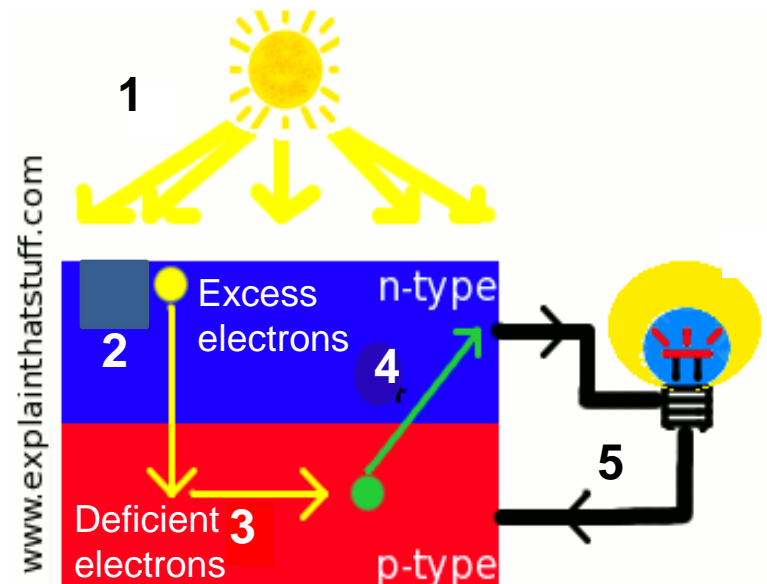

Discoverer of the Photoelectric Principle

Albert Einstein explained the *photoelectric* effect in 1905 for which he received the Nobel prize in Physics in 1921

He was 26 years old!

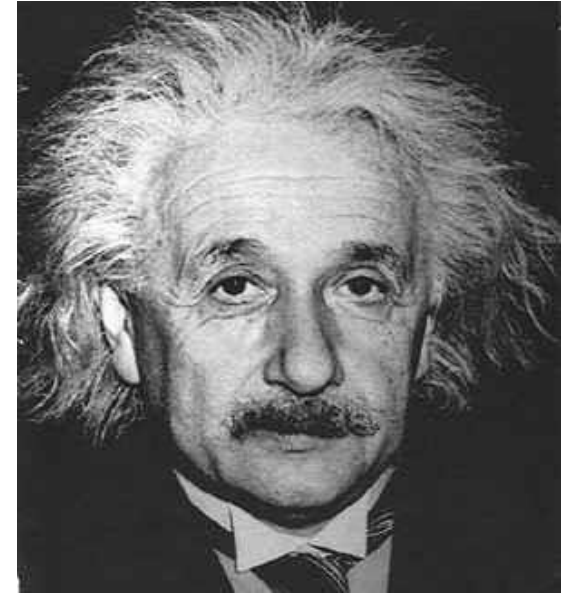

Albert Einstein
1879-1955

Powering the International Space Station

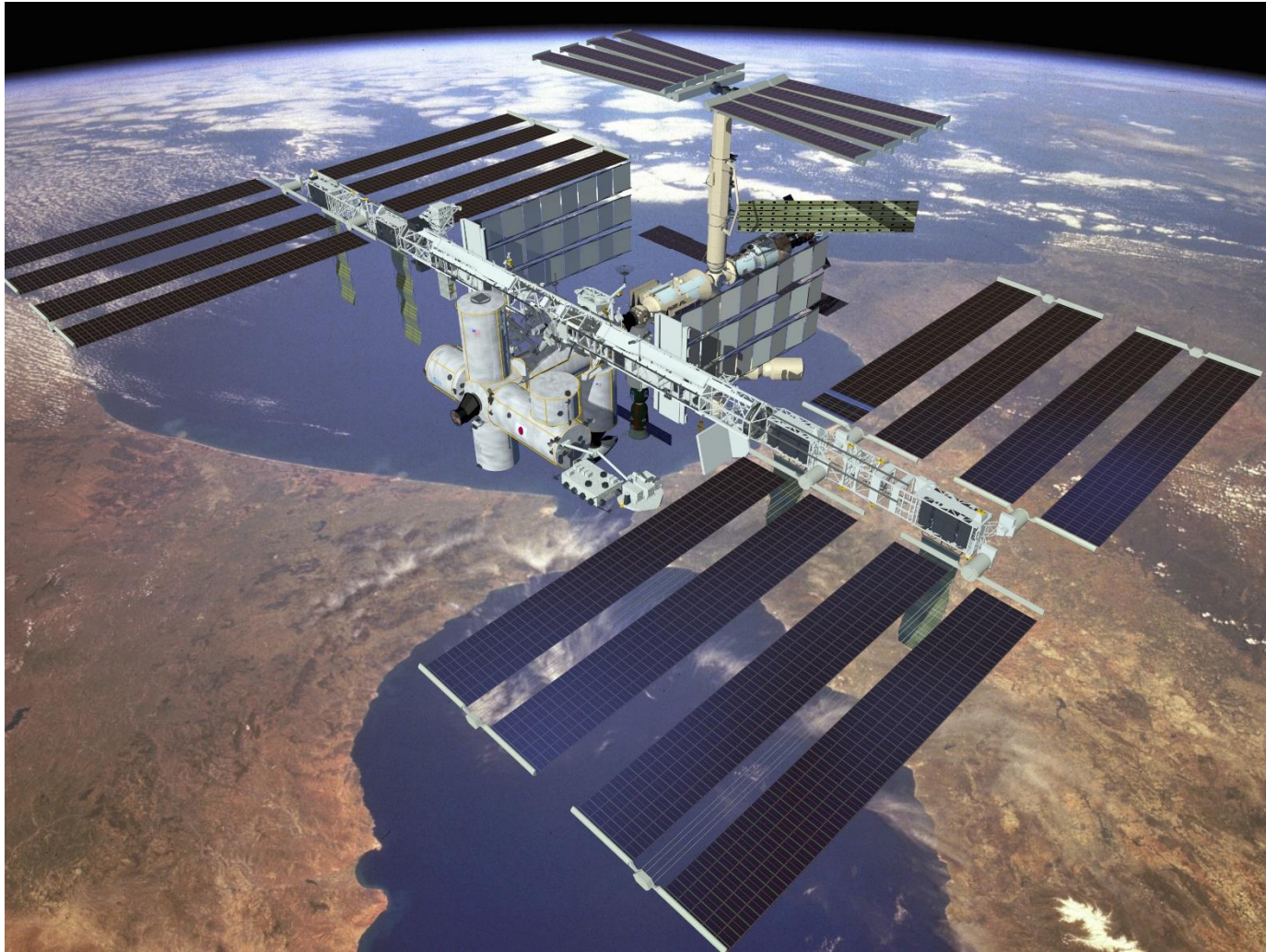

Solar Powered Airplane!



Solar Powered Cars

- A **solar car** is an electric car powered by **solar panels**
- Solar vehicles are primarily demonstration vehicles.



Engineering Our Solar Car

- Design Criteria: 5 mph within .5 sec from standing start
- Engineering Design:
 1. Weight of car -> Force required -> Torque required
 2. Motor RPM/Torque -> Gear ratio -> RPM/Torque at axle
 3. RPM of the axle - > Wheel size -> Speed (velocity) of car
 4. Motor -> Electric power required - > Voltage & Current
 5. Voltage & Current - > Number of Solar Panels -> Weight
 6. Back to #1

Let's Build The Chassis

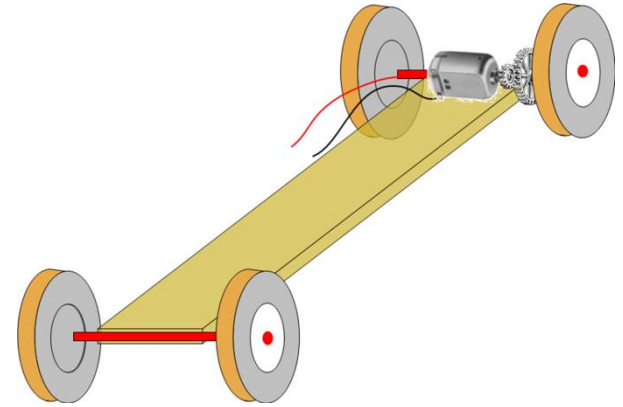

Use foam board or corrugated plastic for the chassis.

Cut the straw length a little wider than the chassis, but slightly less than the axle length..

Assemble the wheels and gears on the axles with the axles through straws, but leave a little slack between the wheels.

Make sure the axles are parallel.

Tape the straws firmly to the chassis; **Taping the straws to the ends of the chassis is the best way to get parallel wheels.**

Clip the motor to the chassis on top of the chassis, NOT underneath the chassis (it will rub on the ground otherwise) and align the gears so they mesh, but not too tightly.

Let's Add the Solar Power

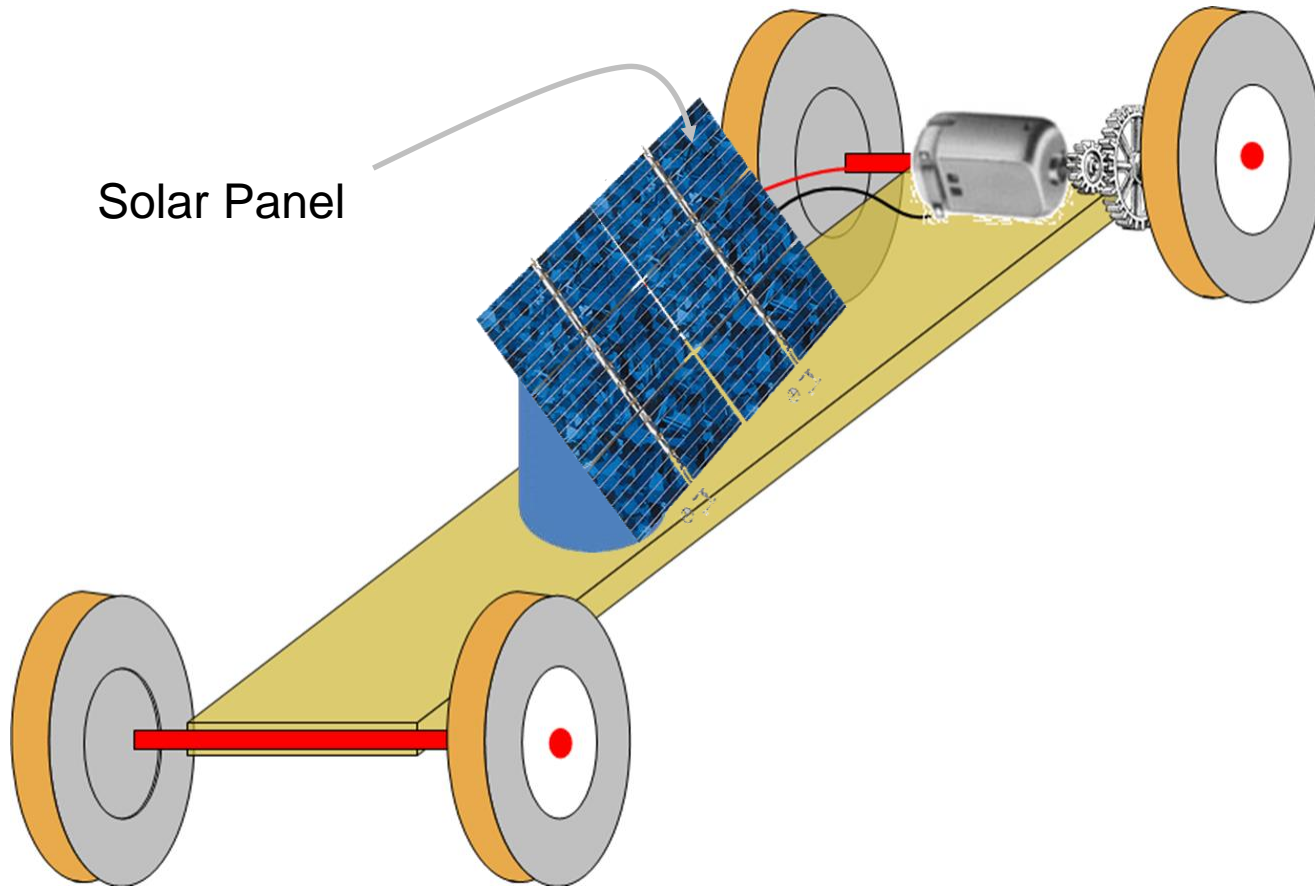

1. Handle the solar panels gently; they are fragile! DON'T bend or cut them!
2. Keep the car as light weight as possible
3. Reverse the wires if the car runs backwards

Let's Race!

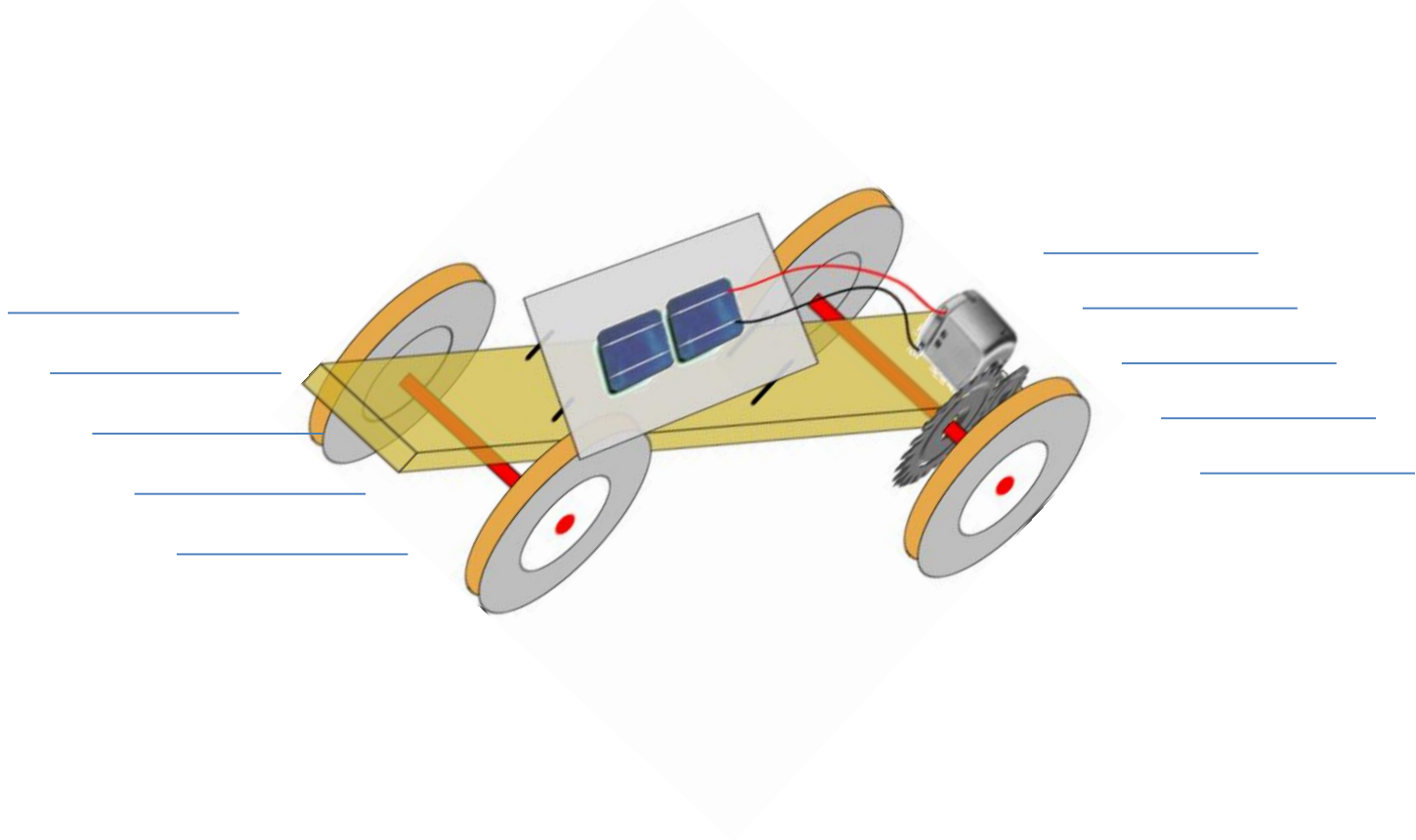

What did we learn today?

- We explored the science, engineering, and technology of Electricity and Solar Energy
- All of the energy on earth comes from the sun*
- How solar cells work
- Electricity is the flow of electrons
- Series and Parallel circuits
- Use math to design machines

*(except nuclear)

Careers in STEM

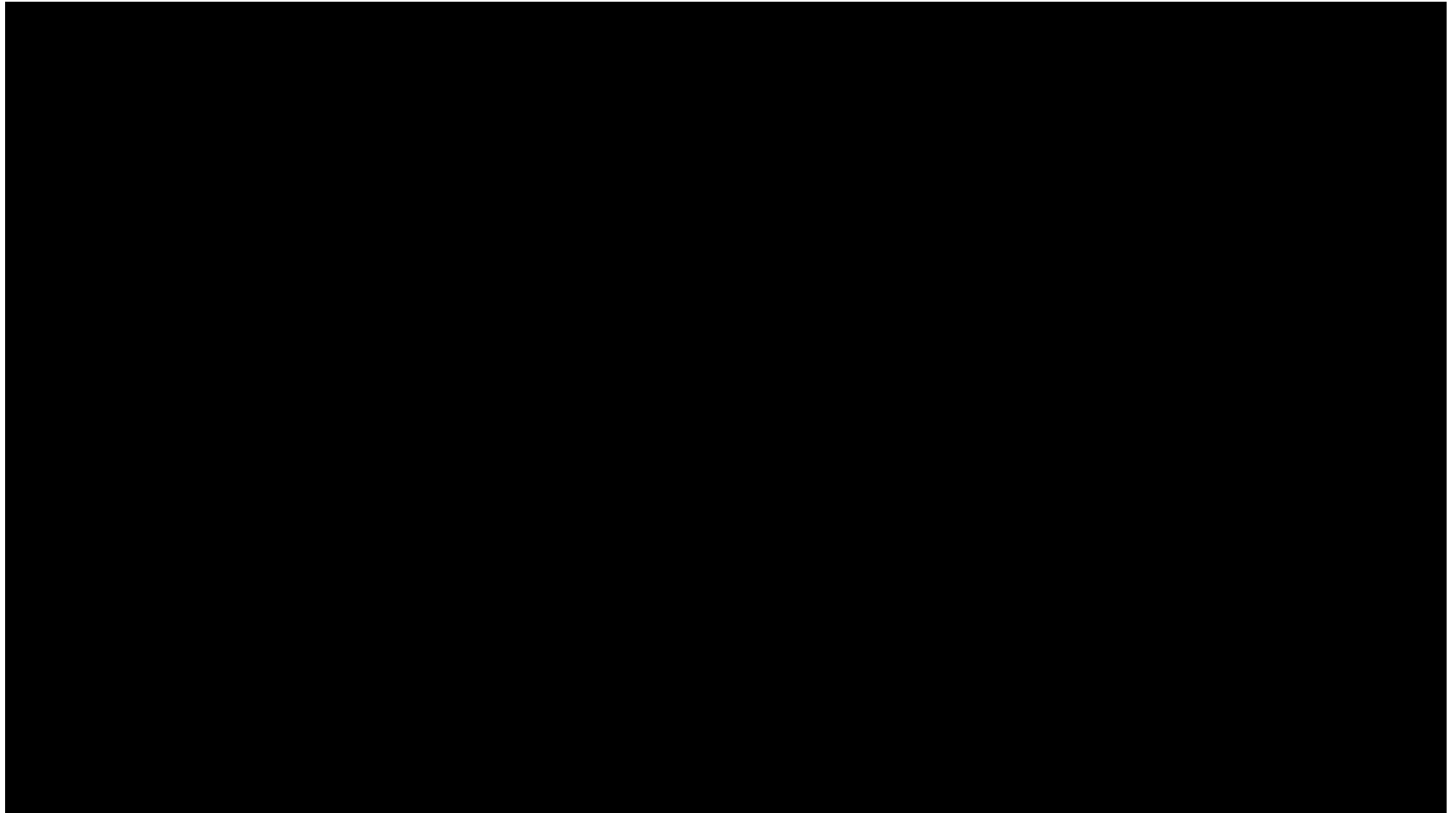

Careers in Science and Engineering

- You must find your passion
- Financially and socially rewarding
- Continuous learning and training (education)
- Maybe even be another Albert Einstein!

Have Fun Today?

Check out our website: www.azsciencelab.org
click on the “For Students” tab!

Thanks for coming and exploring with us
the world of electricity and solar energy!

APPENDIX

Does the speed of the car depend on the size of the wheels?

Calculate the speed of a solar car with 1 inch diameter wheels, and a 4:1 gear ratio, using a 1.5 volt Mabuchi motor.

Problem: Calculate the speed of a solar car with 1 inch diameter wheels, and a 4:1 gear ratio, using a 1.5 volt Mabuchi motor.

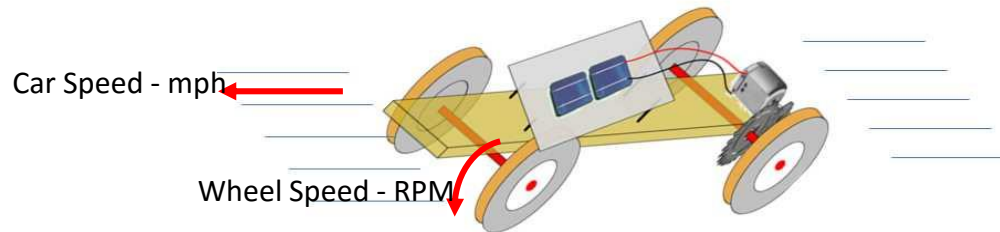

Mabuchi motor Specifications

MODEL	VOLTAGE		NO LOAD			AT MAXIMUM EFFICIENCY				STALL			
	OPERATING RANGE	NOMINAL	SPEED r/min	CURRENT A	SPEED r/min	CURRENT A	TORQUE mN·m	TORQUE g·cm	OUTPUT W	TORQUE mN·m	TORQUE g·cm	CURRENT A	
FA-130RA	2270	1.5 - 3.0	1.5	9100	0.20	6990	0.66	0.59	6.0	0.43	2.55	26	2.20
	18100	1.5 - 3.0	3	12300	0.15	9710	0.56	0.74	7.6	0.76	3.53	36	2.10

Calculate the speed of a solar car with 1 inch diameter wheels, and a 4:1 gear ratio, using a 1.5 volt Mabuchi motor.

From the spec sheet, Motor speed = 6990 RPM, so **Wheel speed** = $6990/4 = 1747$ RPM

Now, for 1 inch dia. Wheels, circumference = $\pi \times 1'' = \pi$ inches

Look at this diagram 

So, we see that 1 revolution of a 1" wheel travels 3.14"

Therefore, 1747rev/min travels $1747 \times 3.14'' = 5487$ inches/min

Now all we have to do is convert inches/min to miles/hours

5487 inches/min $\times 60$ min./1 hour = $329,229$ inches/hour

$329,229$ in/hr $\times 1$ foot/12 in. $\times 1$ mile/5,280 feet = 5.19 miles/hour

Our car will travel at approximately 5.2 mph!



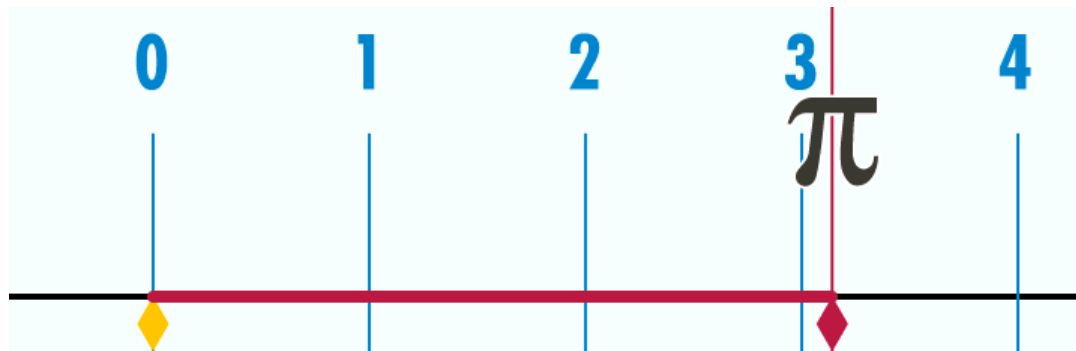

Does the speed of the car depend on the size of the wheels?

*Calculate the speed of a solar car with 1 inch diameter wheels,
and a 4:1 gear ratio, using a 1.5 volt Mabuchi motor.*



Does the speed of the car depend on the size of the wheels?

Calculate the speed of a solar car with 1 inch diameter wheels, and a 4:1 gear ratio, using a 1.5 volt Mabuchi motor.

Motor Speed - 6990 RPM, Wheel Speed - $6990/4 = 1747$ RPM

CIRCUMFERENCE (C) of 1" DIAMETER wheel = $\pi \times 1" = 3.14"$
So 1 REVOLUTION = 3.14"

$1747 \text{ REV/MIN} \times 3.14 \text{ IN} = 5487 \text{ IN/MIN}$

Now $5487 \frac{\text{IN}}{\text{MIN}} \times \frac{60 \text{ MIN}}{1 \text{ hr}} = 329,229 \frac{\text{IN}}{\text{hr}}$

So $329,229 \frac{\text{in}}{\text{hr}} \times \frac{1 \cancel{\text{ft}}}{12 \text{ in}} \times \frac{1 \text{ mile}}{5280 \cancel{\text{ft}}} = 5.19 \frac{\text{miles}}{\text{hr}}$ or
5.2 mph