

STAKE OUT			
A-C	6'8-1/2"	B-C	9'2-5/8"
A-D	11'8"	B-D	6'
A-E	12'11-1/8"	B-E	5'7-1/4"
A-F	17'3"	B-F	18'4-5/8"
A-G	24'-1/2"	B-G	18'4-5/8"

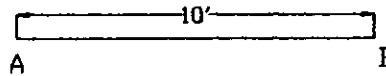

24 BAKER ST. P.O. BOX 100, HASTINGS ON KOL-1YO
 705-696-2385, 1-800-465-3433, FAX: 705-696-1922

14'X26' NORLANDER R.H.

QTY.	LENGTH	RADIUS	TYPE
1	8'0"	7'0"	PLAIN
1	8'0"	7'0"	RETURN
2	6'0"	7'0"	PLAIN
1	8'0"	5'6"	RETURN
1	8'0"	5'6"	PLAIN
1	2'0"	2'0"	REVERSE
1	8'0"	NA	SKIMMER
1	7'0"	NA	PLAIN
1	6'0"	NA	PLAIN
10	-	NA	A-FRAME
1	-	NA	N&B PKG
			S.A.: 285.58 sq.ft
			PER: 67'0"
1426NORL			DATE: 15-11-00

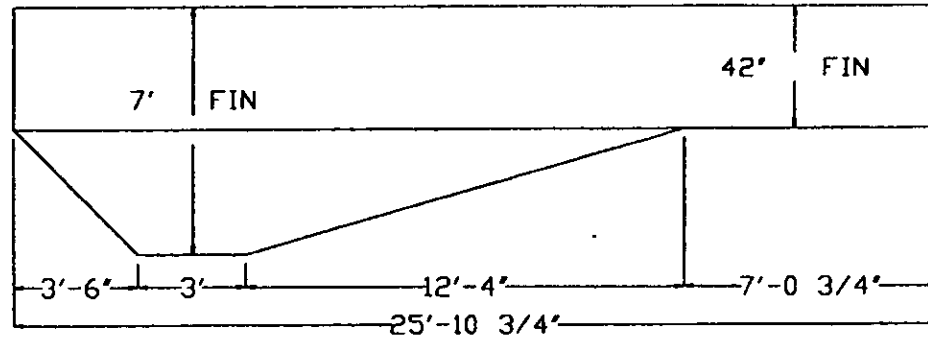

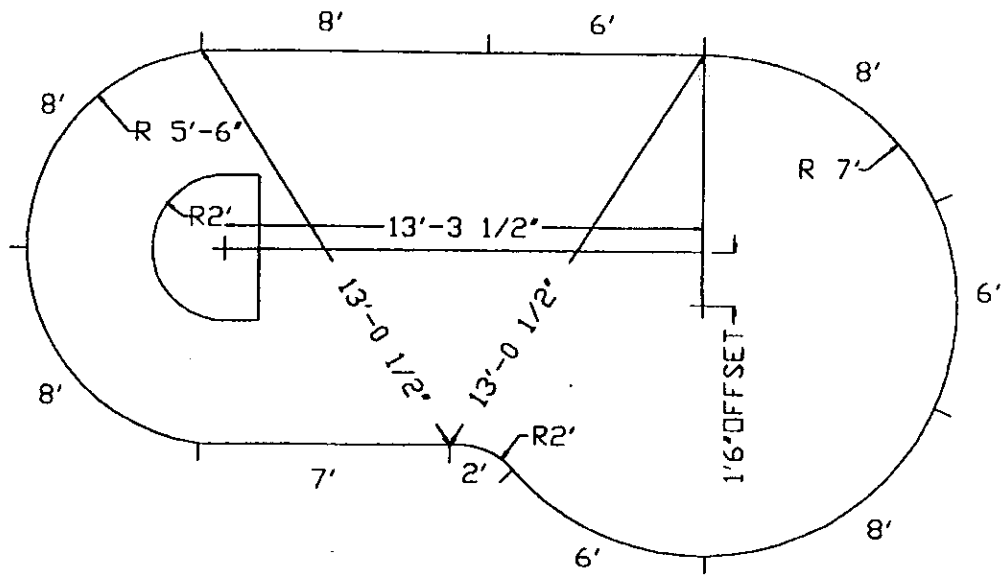
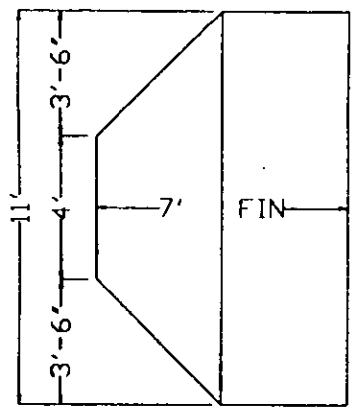

24 BAKER ST., P.O. BOX 100, HASTINGS ON KOL-1Y0
 705-696-2385, 1-800-465-3433, FAX: 705-696-1922

14'X26' NORLANDER R.H.

QTY.	LENGTH	RADIUS	TYPE
1	8'0"	7'0"	PLAIN
1	8'0"	7'0"	RETURN
2	6'0"	7'0"	PLAIN
1	8'0"	5'6"	RETURN
1	8'0"	5'6"	PLAIN
1	2'0"	2'0"	REVERSE
1	8'0"	NA	SKIMMER
1	7'0"	NA	PLAIN
1	6'0"	NA	PLAIN
10	-	NA	A-FRAME
1	-	NA	N&B PKG
			S.A. 285.58 sq.ft
			PER: 67'0"
1426NORL			DATE: 15-11-00

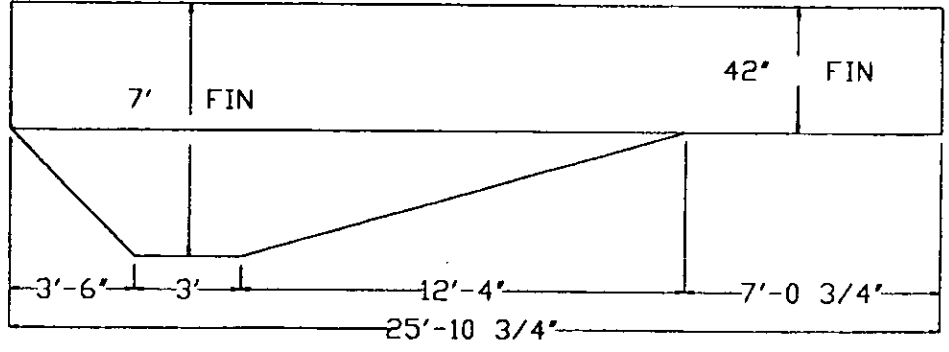

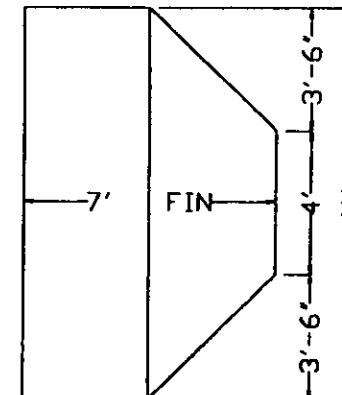
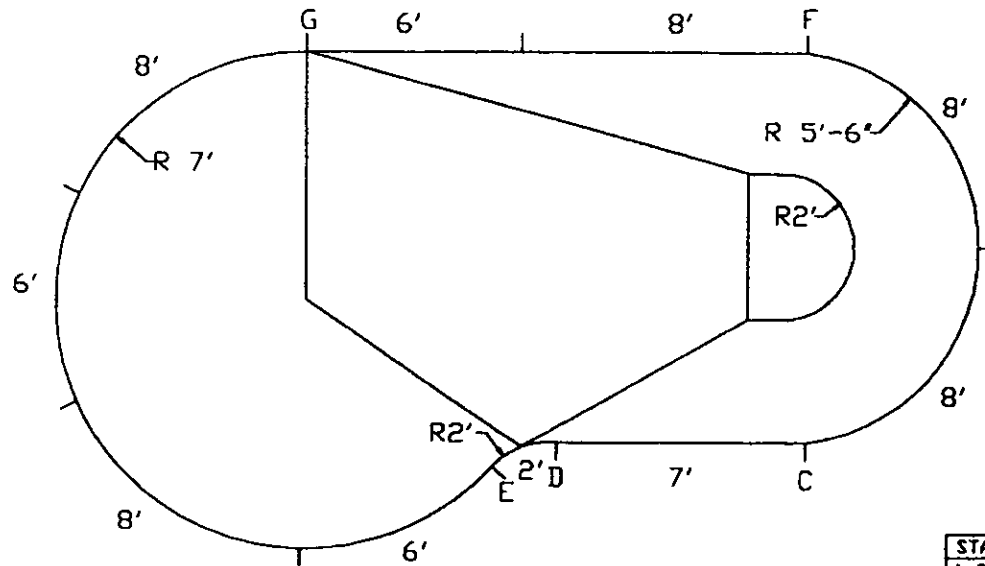

STAKE OUT			
A-C	6'8-1/2"	B-C	9'2-5/8"
A-D	11'8"	B-D	6'
A-E	12'11-1/8"	B-E	5'7-1/4"
A-F	17'3"	B-F	18'4-5/8"
A-G	24'-1/2"	B-G	18'4-5/8"

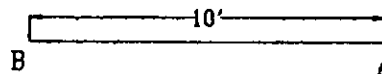

24 BAKER ST. P.O. BOX 100, HASTINGS DNKOL-1Y0
 705-696-2385, 1-800-465-3433, FAX: 705-696-1922

14'X26' NORLANDER L.H.

QTY.	LENGTH	RADIUS	TYPE
1	8'0"	7'0"	PLAIN
1	8'0"	7'0"	RETURN
2	6'0"	7'0"	PLAIN
1	8'0"	5'6"	RETURN
1	8'0"	5'6"	PLAIN
1	2'0"	2'0"	REVERSE
1	8'0"	NA	SKIMMER
1	7'0"	NA	PLAIN
1	6'0"	NA	PLAIN

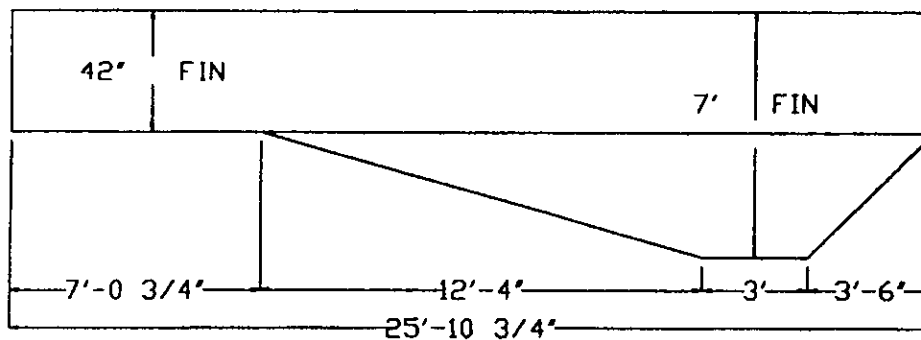

10	-	NA	A-FRAME
1	-	NA	N&B PKG
			SA: 285.58 sq.Ft
			PER: 67'0"
1426NDRL			DATE: 15-11-00

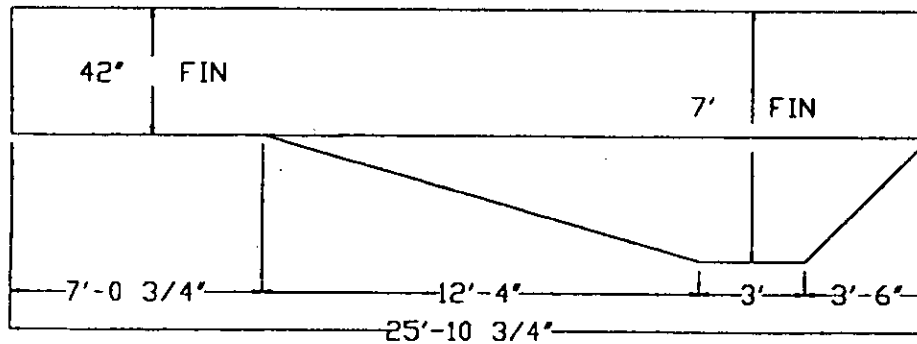
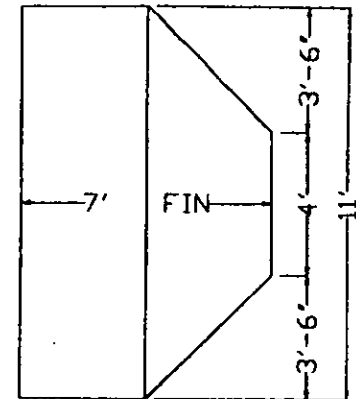
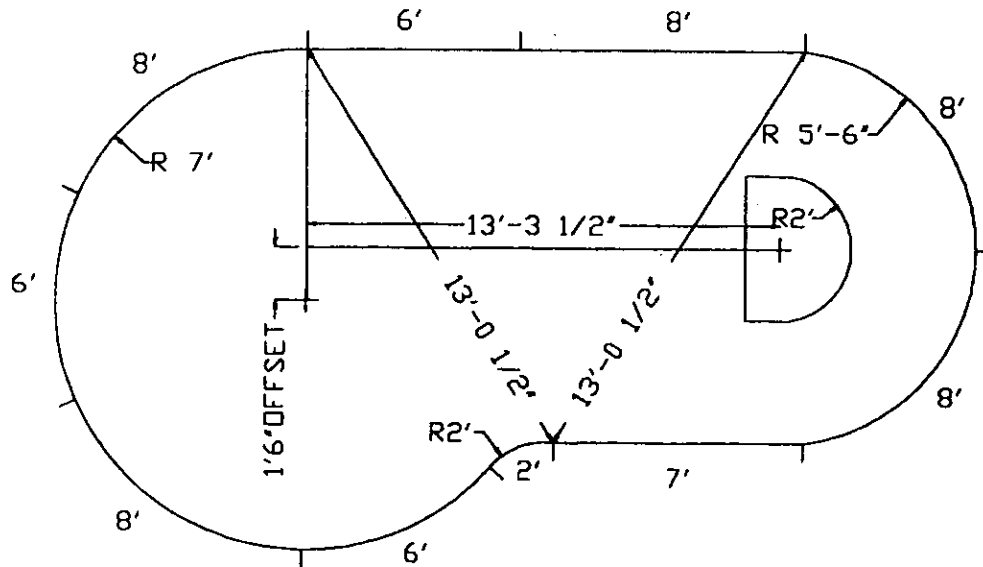

24 BAKER ST., P.O. BOX 100, HASTINGS ON KOL-1Y0
705-696-2385, 1-800-465-3433, FAX 705-696-1922

14'X26' NORLANDER L.H.

QTY.	LENGTH	RADIUS	TYPE
1	8'0"	7'0"	PLAIN
1	8'0"	7'0"	RETURN
2	6'0"	7'0"	PLAIN
1	8'0"	5'6"	RETURN
1	8'0"	5'6"	PLAIN
1	2'0"	2'0"	REVERSE
1	8'0"	NA	SKIMMER
1	7'0"	NA	PLAIN
1	6'0"	NA	PLAIN

10	-	NA	A-FRAME
1	-	NA	N&B PKG
			S.A. 285.58 sq.ft
			PER: 67'0"
1426NORL			DATE: 15-11-00

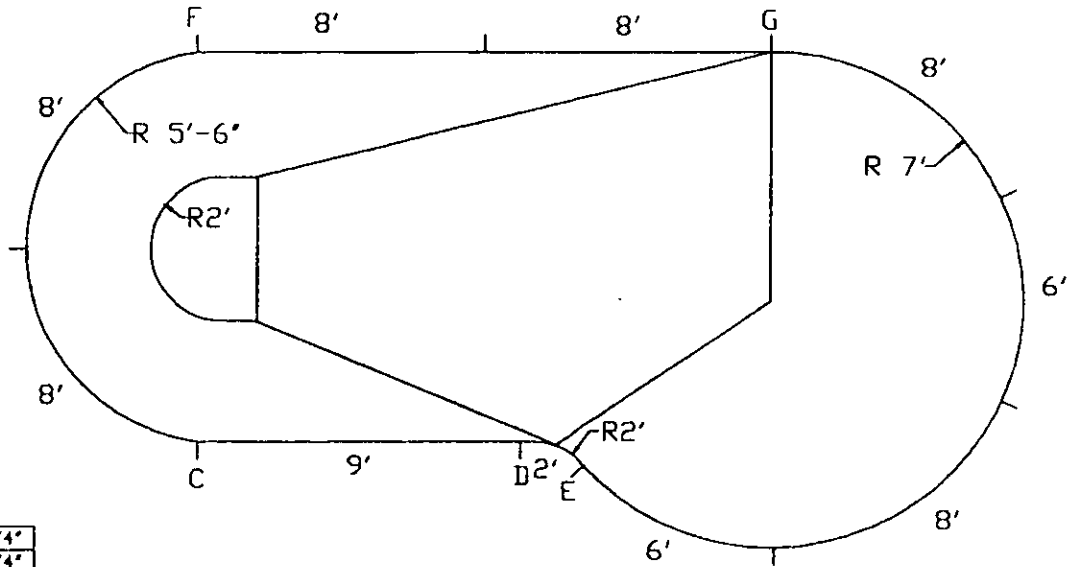
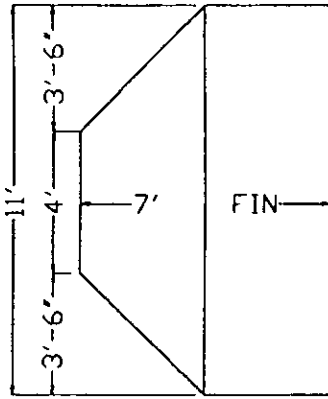

STAKE OUT			
A-C	6'8-1/4"	B-C	9'2-3/4"
A-D	13'4-3/4"	B-D	6'3-3/4"
A-E	14'9-3/4"	B-E	6'7"
A-F	17'3"	B-F	18'4-5/8"
A-G	26'	B-G	19'2-3/4"

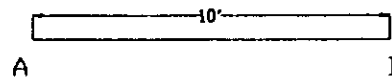

24 BAKER ST, P.O. BOX 100, HASTINGS DN, KOL-1Y0
 705-696-2385, 1-800-465-3433, FAX: 705-696-1922

14'X28' NORLANDER R.H.

QTY.	LENGTH	RADIUS	TYPE
1	8'0"	7'0"	PLAIN
1	8'0"	7'0"	RETURN
2	6'0"	7'0"	PLAIN
1	8'0"	5'6"	RETURN
1	8'0"	5'6"	PLAIN
1	2'0"	2'0"	REVERSE
1	9'0"	NA	PLAIN
1	8'0"	NA	SKINMER
1	8'0"	NA	PLAIN
10	-	NA	A-FRAME
1	-	NA	N&B PKG
			S.A.: 306.38 sq.ft
			PER: 71'
1428NORL			DATE: 15-11-00

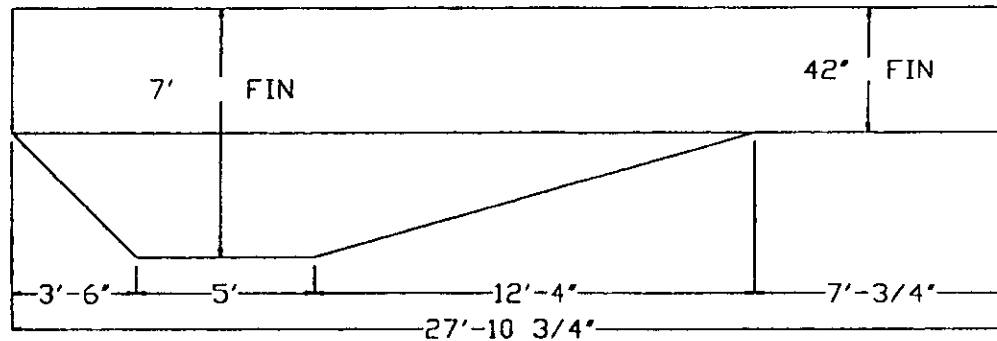

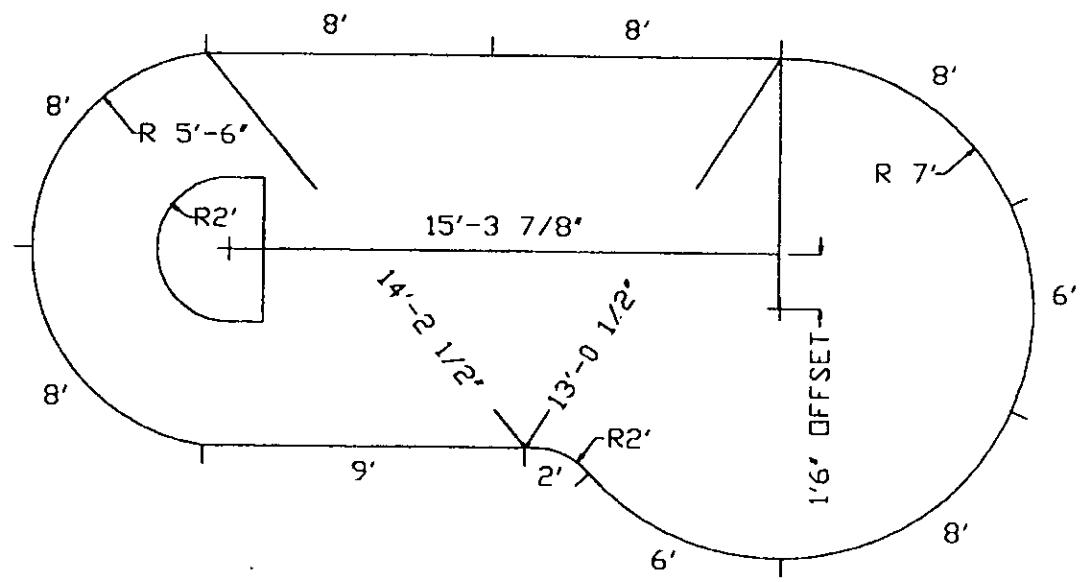
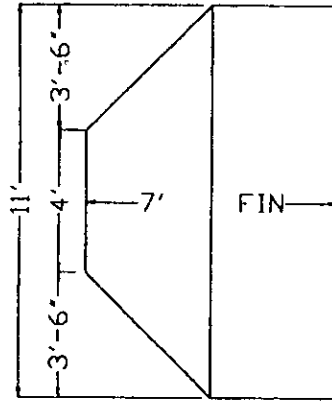

24 BAKER ST., P.O. BOX 100, HASTINGS ON KOL-1Y0
 705-696-2385, 1-800-465-3433, FAX: 705-696-1922

14'X28' NORLANDER R.H.

QTY.	LENGTH	RADIUS	TYPE
1	8'0"	7'0"	PLAIN
1	8'0"	7'0"	RETURN
2	6'0"	7'0"	PLAIN
1	8'0"	5'6"	RETURN
1	8'0"	5'6"	PLAIN
1	2'0"	2'0"	REVERSE
1	9'0"	NA	PLAIN
1	8'0"	NA	SKIMMER
1	8'0"	NA	PLAIN
10	-	NA	A-FRAME
1	-	NA	N&B PKG
			S.A. 306.38 sq.ft
			PER 71'
1428NDRL			DATE: 15-11-00

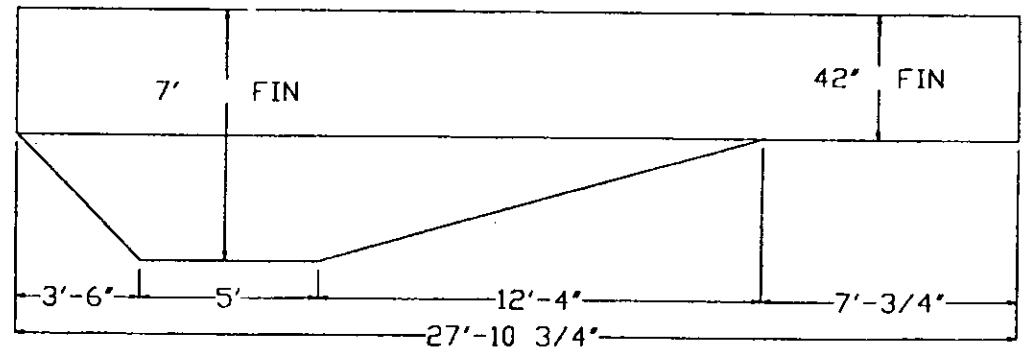

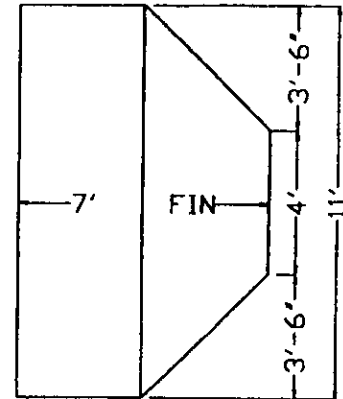
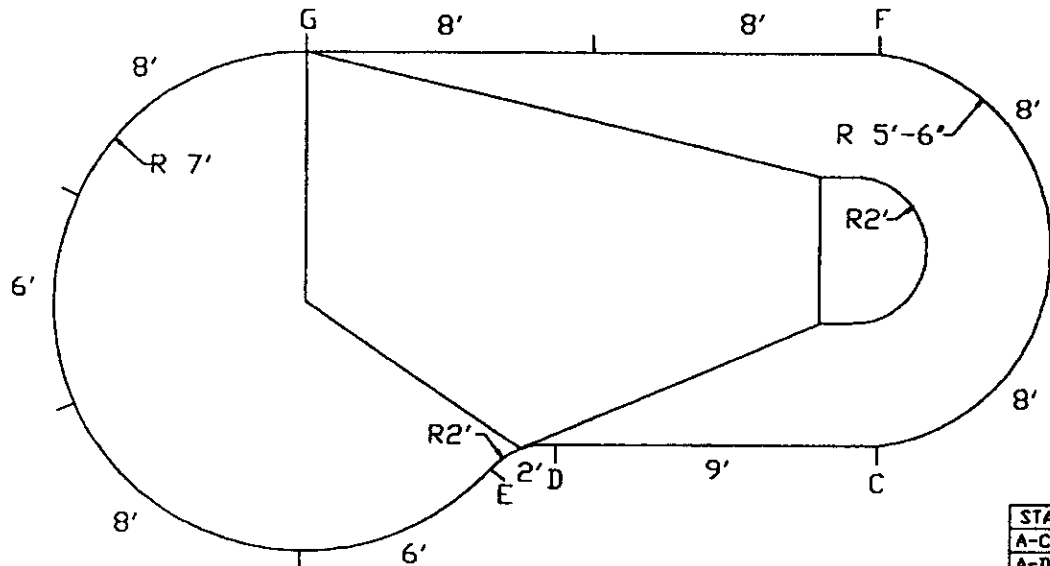

STAKE OUT			
A-C	6'8-1/4'	B-C	9'2-3/4'
A-D	13'4-3/4'	B-D	6'3-3/4'
A-E	14'9-3/4'	B-E	6'7"
A-F	17'3"	B-F	18'4-5/8"
A-G	26'	B-G	19'2-3/4'

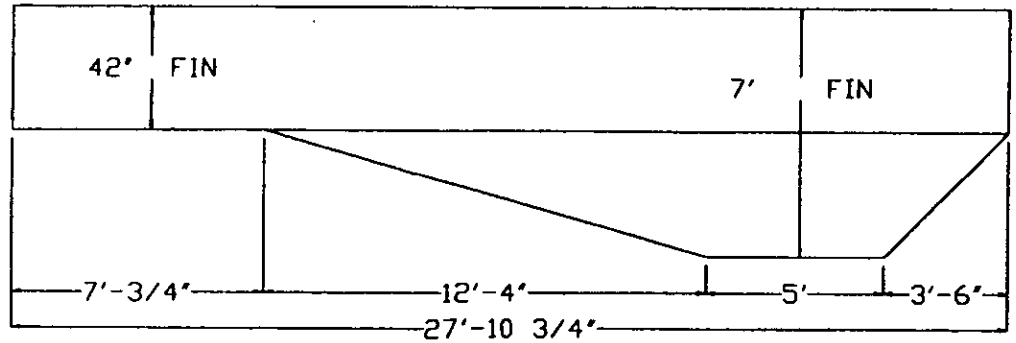
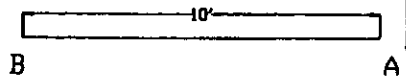

24 BAKER ST. P.O. BOX 100, HASTINGS ON KOL - 1Y0
 705-696-2383, 1-800-465-3433, FAX: 705-696-1922

14'X28' NORLANDER L.H.

QTY.	LENGTH	RADIUS	TYPE
1	8'0"	7'0"	PLAIN
1	8'0"	7'0"	RETURN
2	6'0"	7'0"	PLAIN
1	8'0"	5'6"	RETURN
1	8'0"	5'6"	PLAIN
1	2'0"	2'0"	REVERSE
1	9'0"	NA	PLAIN
1	8'0"	NA	SKIMMER
1	8'0"	NA	PLAIN
10	-	NA	A-FRAME
1	-	NA	N&B PKG
			S.A. 306.38 sq.ft
			PER 7'
1428NDRL			DATE: 15-11-00

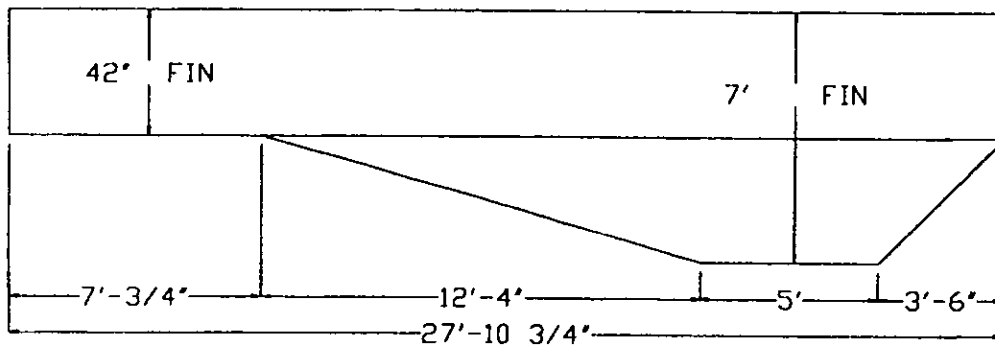
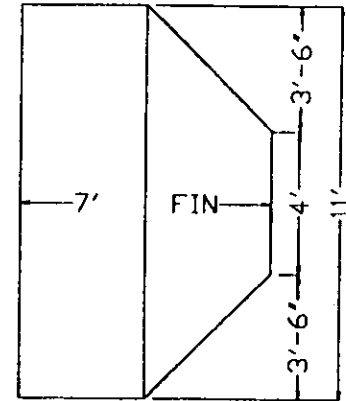
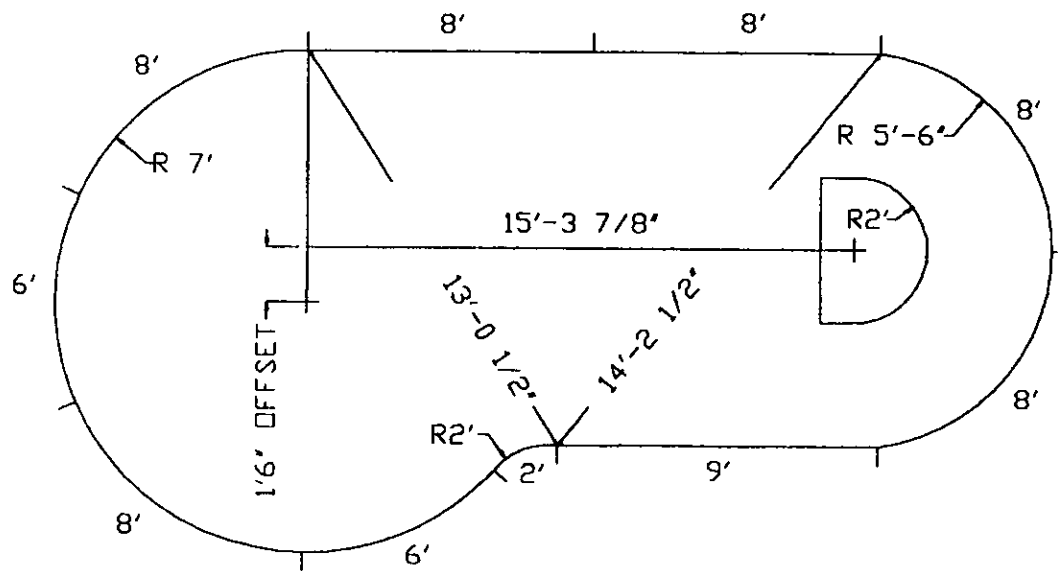

24 BAKER ST. P.O. BOX 100, HASTINGS ON KOL - 1Y0
705-696-2385, 1-800-465-3433, FAX: 705-696-1922

14'X28' NORLANDER L.H.

QTY.	LENGTH	RADIUS	TYPE
1	8'0"	7'0"	PLAIN
1	8'0"	7'0"	RETURN
2	6'0"	7'0"	PLAIN
1	8'0"	5'6"	RETURN
1	8'0"	5'6"	PLAIN
1	2'0"	2'0"	REVERSE
1	9'0"	NA	PLAIN
1	8'0"	NA	SKIMMER
1	8'0"	NA	PLAIN
10	-	NA	A-FRAME
1	-	NA	N&B PKG
			S.A. 306.38 sq.ft
			PER 71'
1428NDRL			DATE: 15-11-00

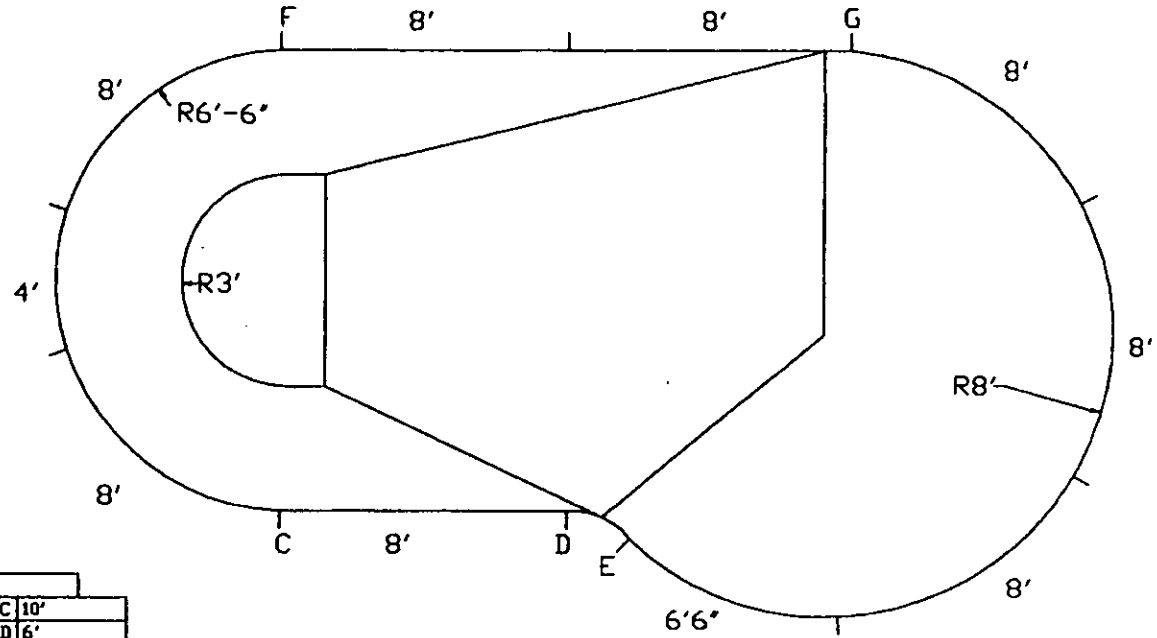
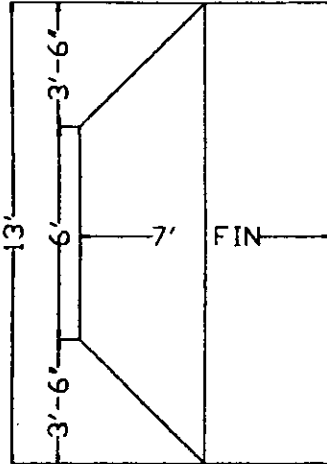

STAKE OUT			
A-C	6'3-7/8"	B-C	10'
A-D	11'8"	B-D	6'
A-E	12'10-1/2"	B-E	5'6-3/8"
A-F	19'1-1/4"	B-F	20'7-3/8"
A-G	26'2"	B-G	20'7-3/8"
A-H		B-H	

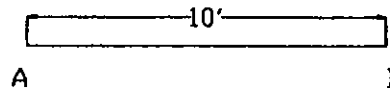

24 BAKER ST. P.O. BOX 100, HASTINGS ON KOL-1Y0
 705-696-2383, 1-800-465-3433 FAX: 705-696-1922

16'X30' NORLANDER R.H.

QTY.	LENGTH	RADIUS	TYPE
2	8'0"	8'0"	PLAIN
1	8'0"	8'0"	RETURN
1	6'6"	8'0"	PLAIN
1	8'0"	6'6"	PLAIN
1	8'0"	6'6"	RETURN
1	4'0"	6'6"	PLAIN
1	2'0"	2'0"	REVERSE
1	8'0"	NA	SKIMMER
2	8'0"	NA	PLAIN

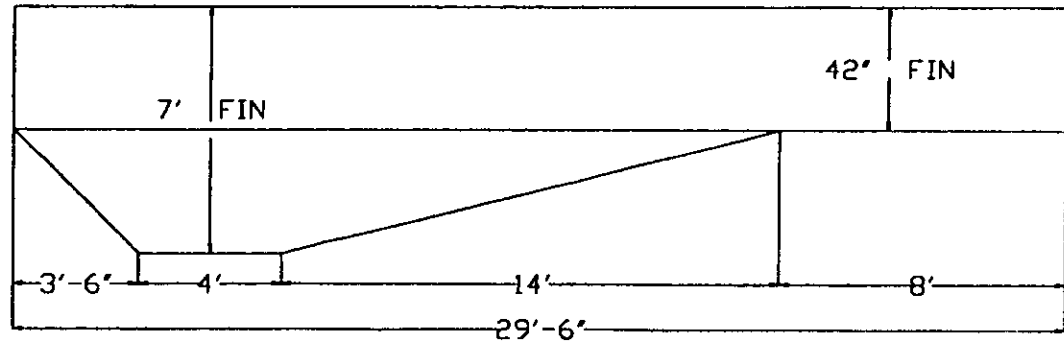

11	-	NA	A-FRAME
1	-	NA	N&B PKG
			S.A: 375 sq.ft
			PER: 76'6"
1630NORL			DATE 03-13-03

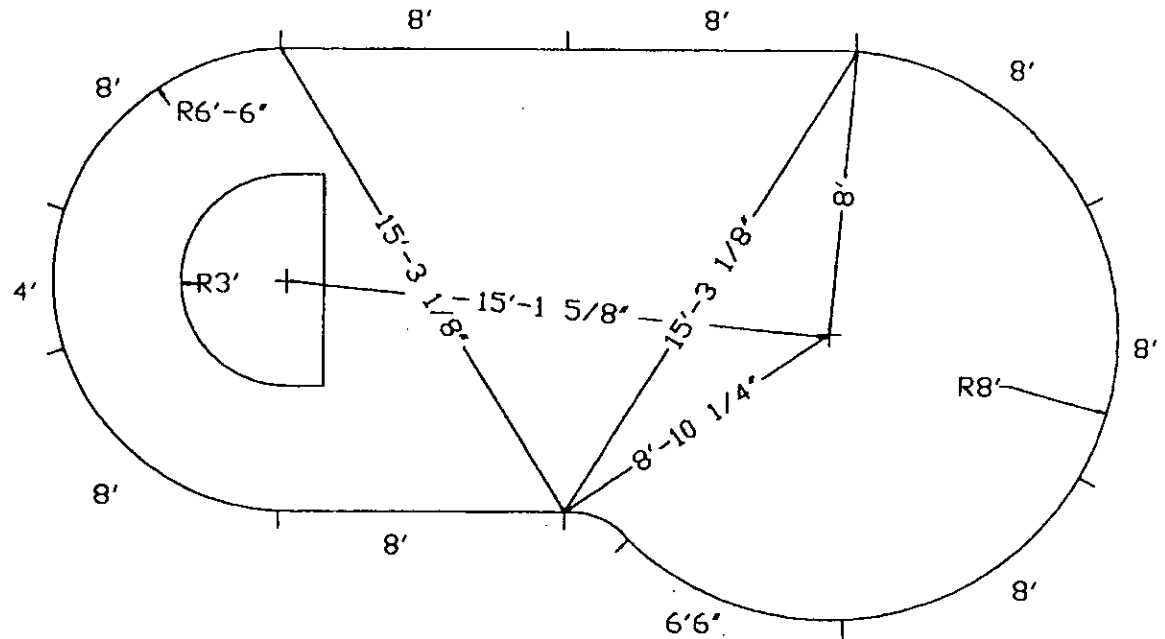
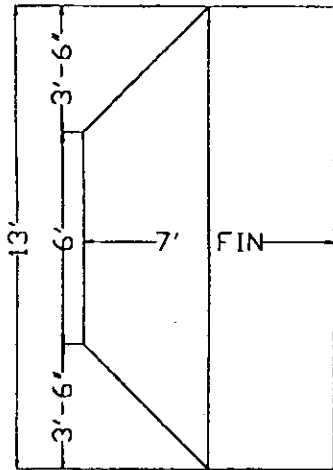

24 BAKER ST, P.O. BOX 100, HASTINGS ON KOL - 1Y0
 705-696-2385, 1-800-465-3433, FAX 705-696-1922

16'X30' NORLANDER R.H.

QTY.	LENGTH	RADIUS	TYPE
2	8'0"	8'0"	PLAIN
1	8'0"	8'0"	RETURN
1	6'6"	8'0"	PLAIN
1	8'0"	6'6"	PLAIN
1	8'0"	6'6"	RETURN
1	4'0"	6'6"	PLAIN
1	2'0"	2'0"	REVERSE
1	8'0"	NA	SKIMMER
2	8'0"	NA	PLAIN

11	-	NA	A-FRAME
1	-	NA	N&B PKG
			S.A.: 375 sq.ft
			PER: 76'6"
1630NDRL			DATE 03-13-03

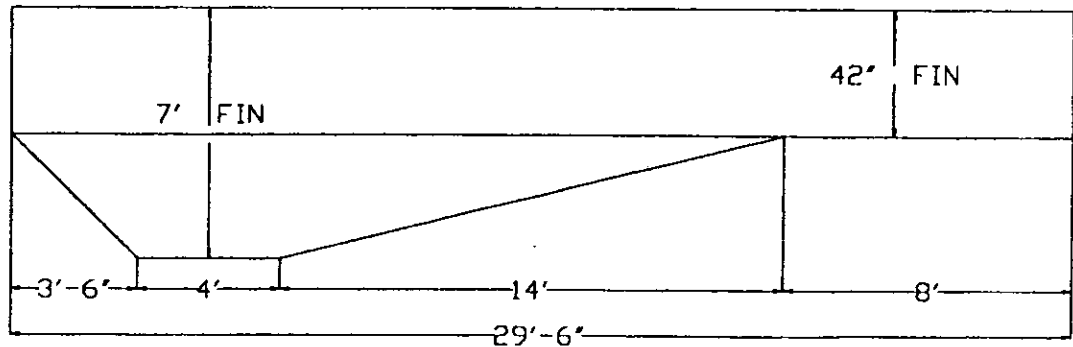

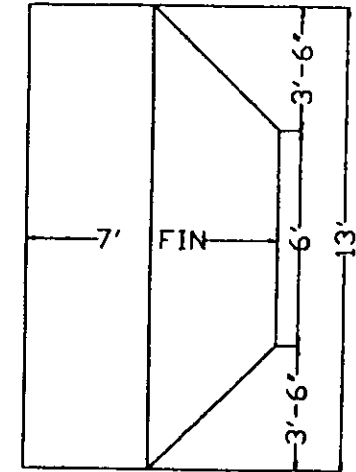
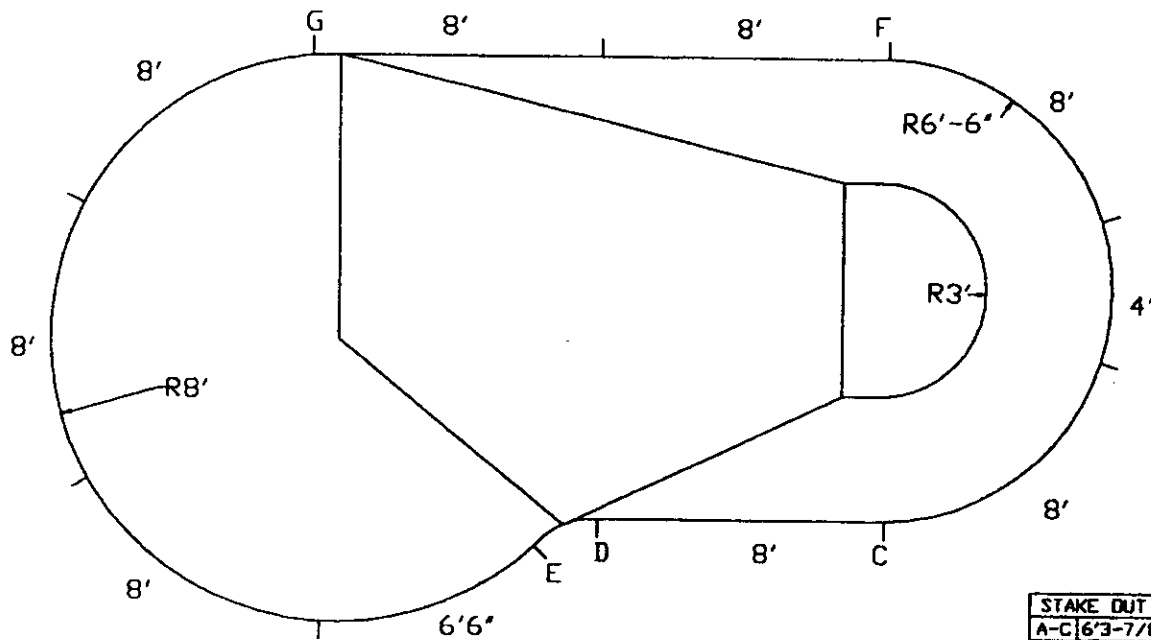

STAKE OUT			
A-C	6'3-7/8"	B-C	10'
A-D	11'8"	B-D	6'
A-E	12'10-1/2"	B-E	5'6-3/8"
A-F	19'1-1/4"	B-F	20'7-3/8"
A-G	26'2"	B-G	20'7-3/8"
A-H		B-H	

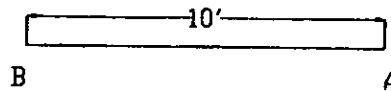

24 BAKER ST. P.O. BOX 100, HASTINGS ON KOL-1YO
 705-696-2385, 1-800-465-3433, FAX 705-696-1922

16'X30' NORLANDER L.H.

QTY.	LENGTH	RADIUS	TYPE
2	8'0"	8'0"	PLAIN
1	8'0"	8'0"	RETURN
1	6'6"	8'0"	PLAIN
1	8'0"	6'6"	PLAIN
1	8'0"	6'6"	RETURN
1	4'0"	6'6"	PLAIN
1	2'0"	2'0"	REVERSE
1	8'0"	NA	SKIMMER
2	8'0"	NA	PLAIN
11	-	NA	A-FRAME
1	-	NA	N&B PKG
			S.A. 375 sq.ft
			PER: 76'6"
1630NORL			DATE: 03-13-03

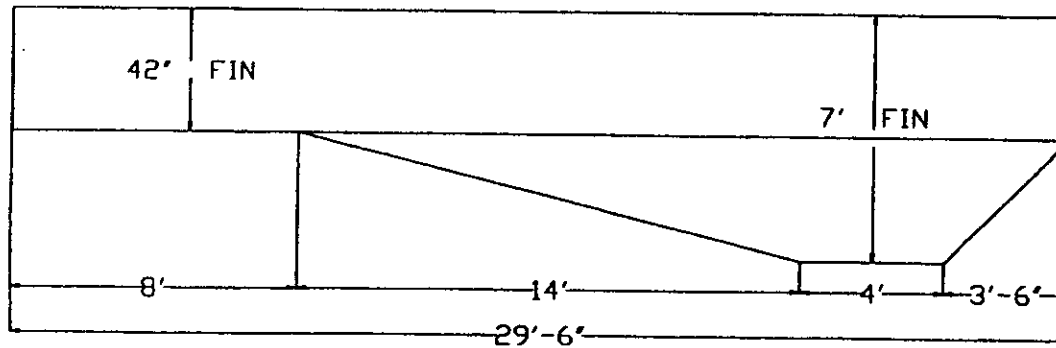

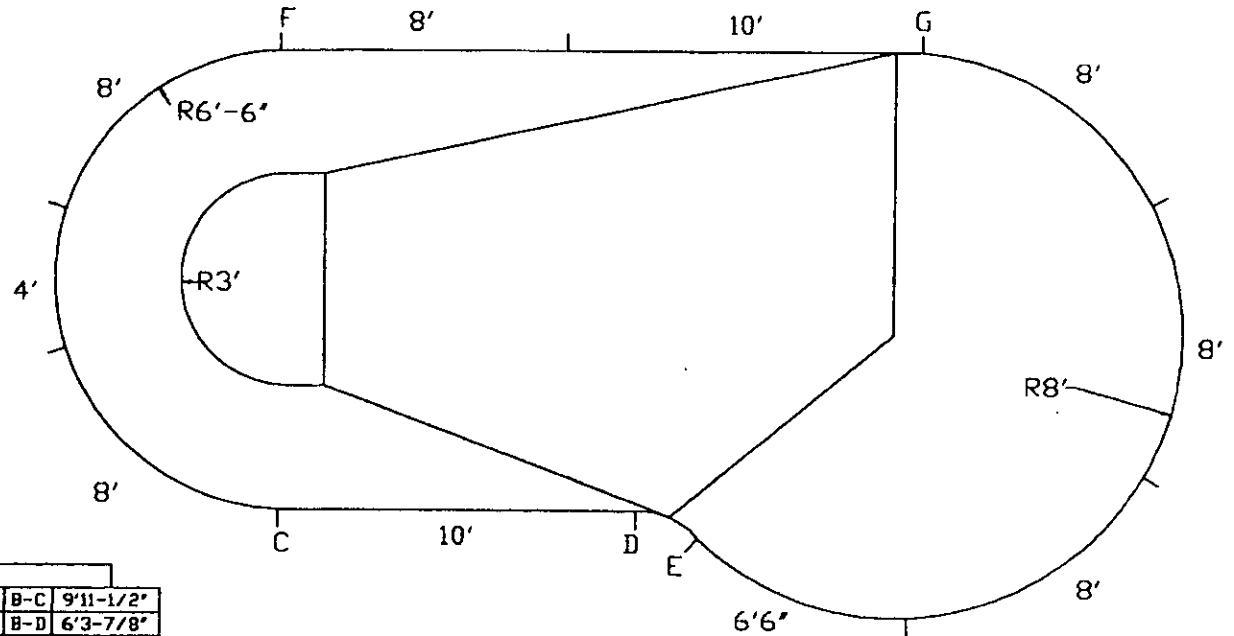
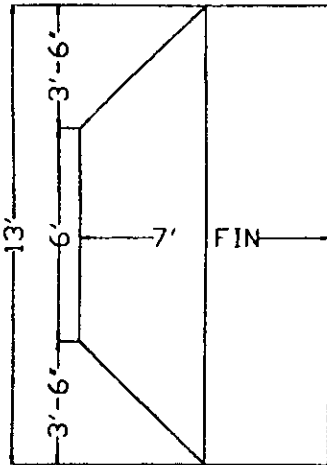

STAKE OUT			
A-C	6'4-1/4"	B-C	9'11-1/2"
A-D	13'5"	B-D	6'3-7/8"
A-E	14'8-1/2"	B-E	6'5"
A-F	19'1-1/4"	B-F	20'7-3/8"
A-G	27'7"	B-G	21'5-1/4"

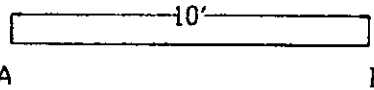

24 BAKER ST., P.O. BOX 100, HASTINGS ON KOL - 1Y0
 705-696-2385, 1-800-465-3433, FAX: 705-696-1922

16'X32' NORLANDER R.H.

QTY.	LENGTH	RADIUS	TYPE
2	8'0"	8'0"	PLAIN
1	8'0"	8'0"	RETURN
1	6'6"	8'0"	PLAIN
1	8'0"	6'6"	PLAIN
1	8'0"	6'6"	RETURN
1	4'0"	6'6"	PLAIN
1	2'0"	2'0"	REVERSE
2	10'0"	NA	PLAIN
1	8'0"	NA	SKIMMER
11	-	NA	A-FRAME
1	-	NA	N&B PKG
			S.A.: 401 sq.ft
			PER: 80'6"
1632NORL			DATE: 15-11-00

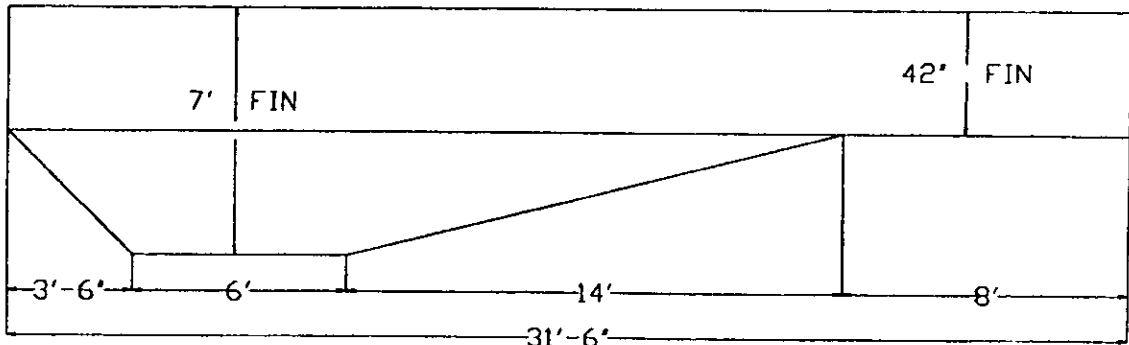

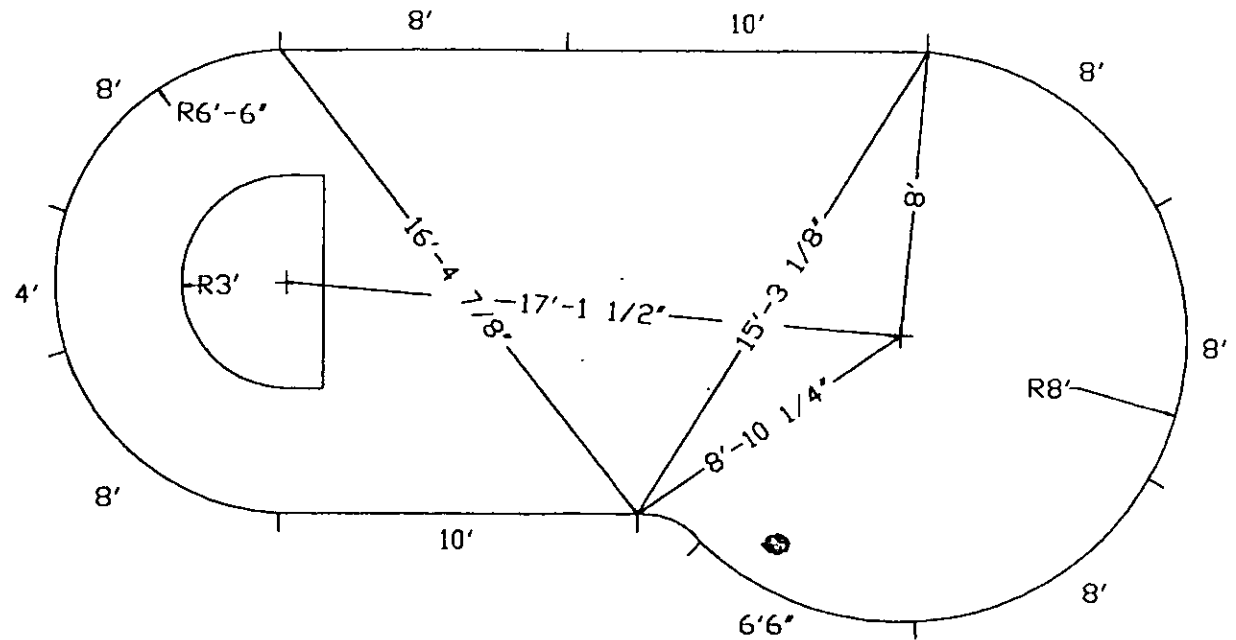
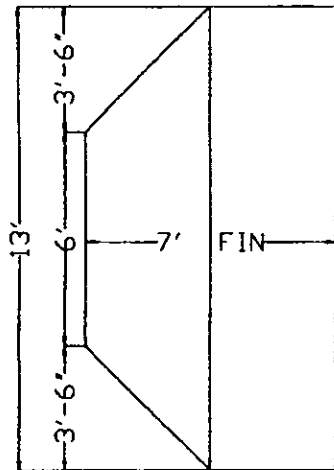

24 BAKER ST., P.O. BOX 100, HASTINGS DN, KOL-1Y0
 705-696-2385, 1-800-465-3433, FAX: 705-696-1922

16'X32' NORLANDER R.H.

QTY.	LENGTH	RADIUS	TYPE
2	8'0"	8'0"	PLAIN
1	8'0"	8'0"	RETURN
1	6'6"	8'0"	PLAIN
1	8'0"	6'6"	PLAIN
1	8'0"	6'6"	RETURN
1	4'0"	6'6"	PLAIN
1	2'0"	2'0"	REVERSE
2	10'0"	NA	PLAIN
1	8'0"	NA	SKIMMER
11	-	NA	A-FRAME
1	-	NA	N&B PKG
			S.A. 401 sq.ft
			PER: 80'6"
1632NDRL			DATE: 15-11-00

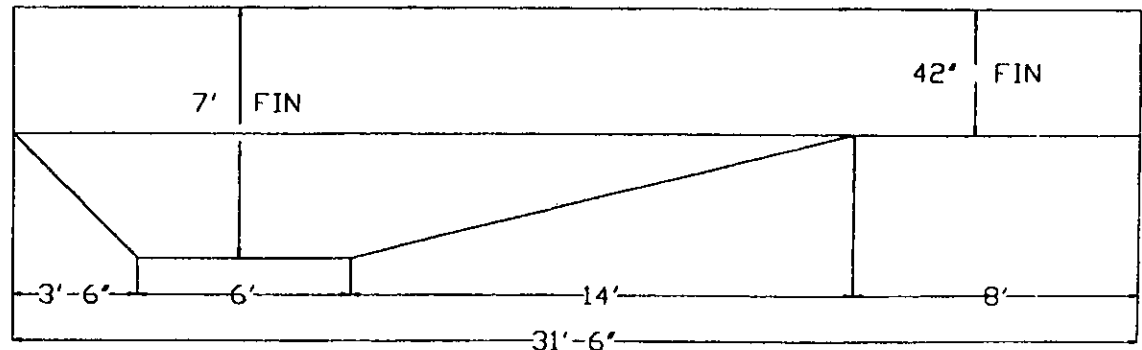

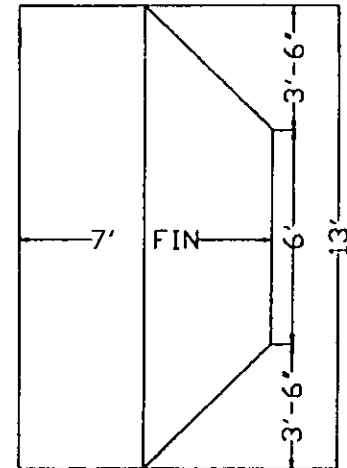
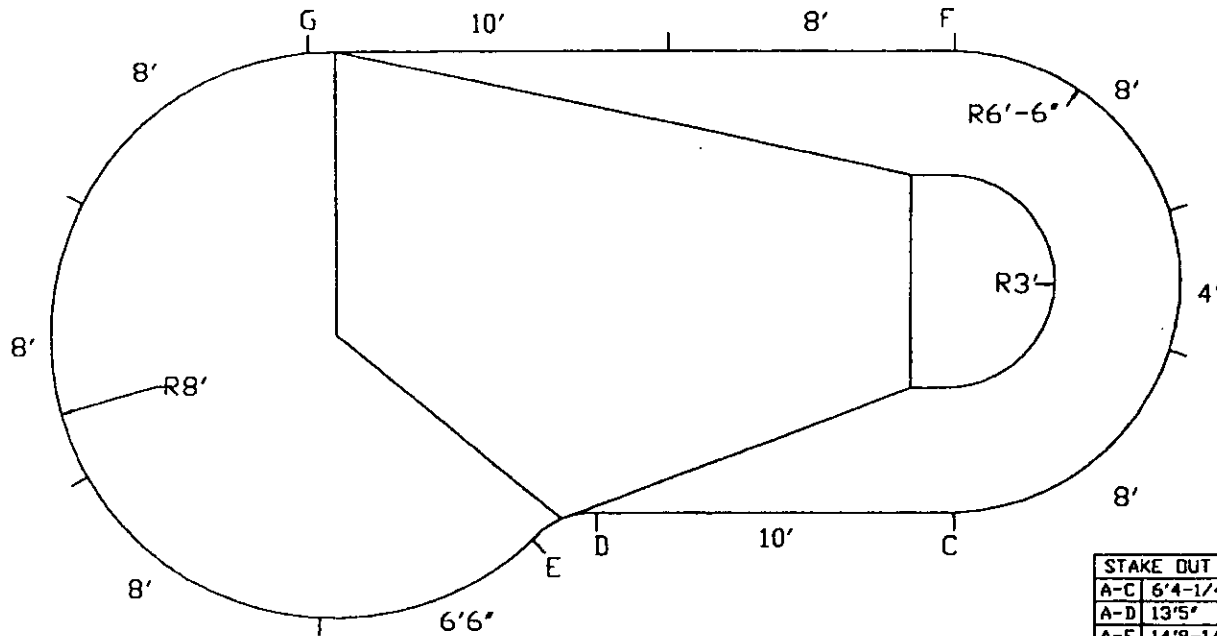

STAKE OUT			
A-C	6'4-1/4"	B-C	9'11-1/2"
A-D	13'5"	B-D	6'3-7/8"
A-E	14'8-1/2"	B-E	6'5"
A-F	19'1-1/4"	B-F	20'7-3/8"
A-G	27'7"	B-G	21'5-1/4"

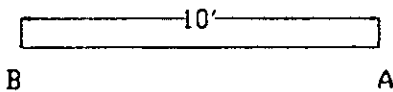

24 BAKER ST., P.O. BOX 100, HASTINGS DNKOL-1YO
 705-696-2385, 1-800-465-3433, FAX: 705-696-1922

16'X32' NORLANDER L.H.

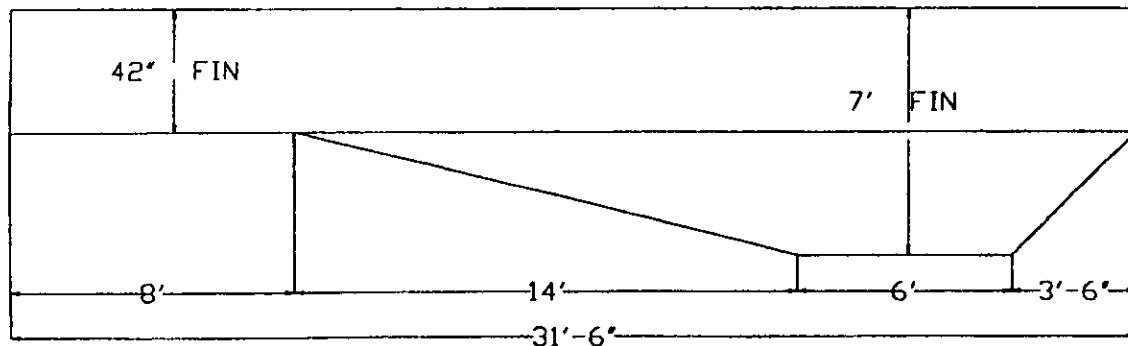

QTY.	LENGTH	RADIUS	TYPE
2	8'0"	8'0"	PLAIN
1	8'0"	8'0"	RETURN
1	6'6"	8'0"	PLAIN
1	8'0"	6'6"	PLAIN
1	8'0"	6'6"	RETURN
1	4'0"	6'6"	PLAIN
1	2'0"	2'0"	REVERSE
2	10'0"	NA	PLAIN
1	8'0"	NA	SKIMMER
11	-	NA	A-FRAME
1	-	NA	N&B PKG
			S.A. 401 sq.Ft
			PER: 80'6"

1632NDRL DATE: 15-11-00

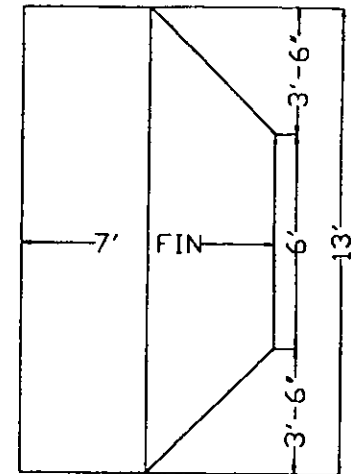
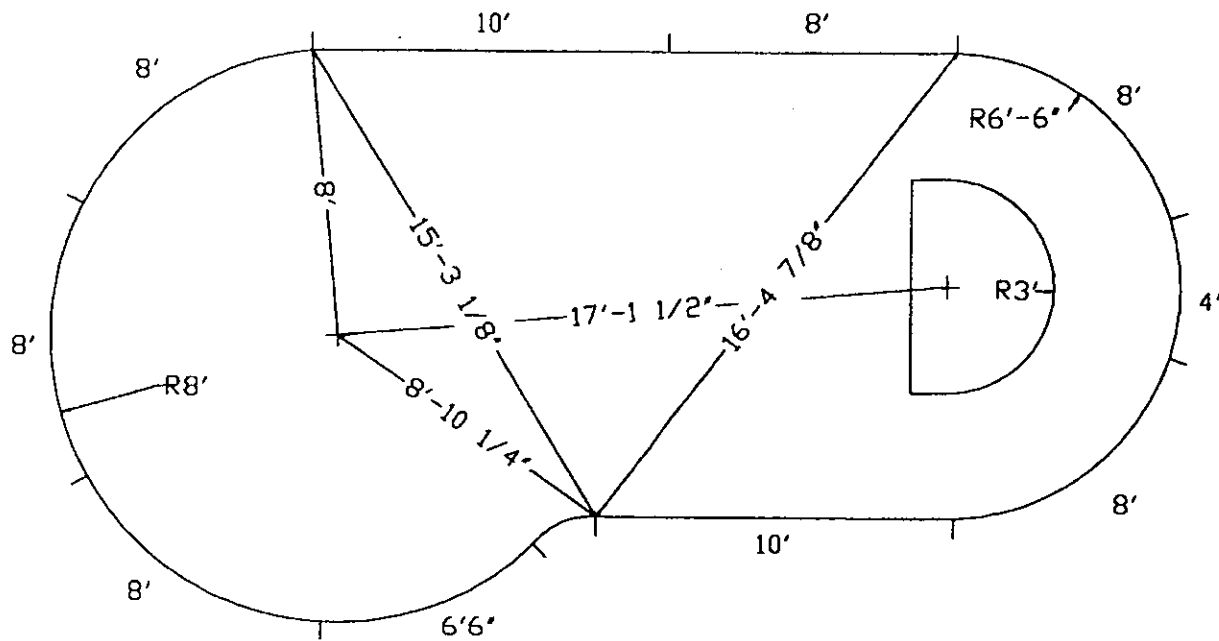

24 BAKER ST., P.O. BOX 100, HASTINGS ON KOL - 1Y0
705-696-2385, 1-800-465-3433, FAX: 705-696-1922

16'X32' NORLANDER L.H.

QTY.	LENGTH	RADIUS	TYPE
2	8'0"	8'0"	PLAIN
1	8'0"	8'0"	RETURN
1	6'6"	8'0"	PLAIN
1	8'0"	6'6"	PLAIN
1	8'0"	6'6"	RETURN
1	4'0"	6'6"	PLAIN
1	2'0"	2'0"	REVERSE
2	10'0"	NA	PLAIN
1	8'0"	NA	SKIMMER

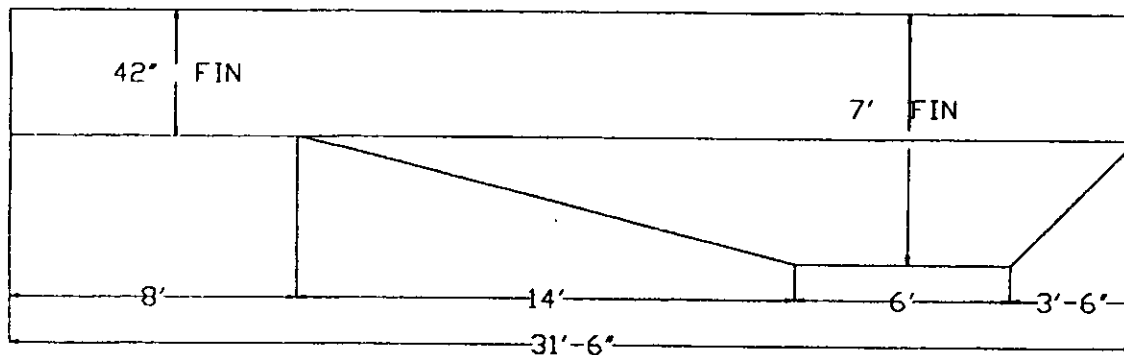

11	-	NA	A-FRAME
1	-	NA	N&B PKG
			SA: 401 sq.ft
			PER: 80'6"
1632NDRL			DATE: 15-11-00

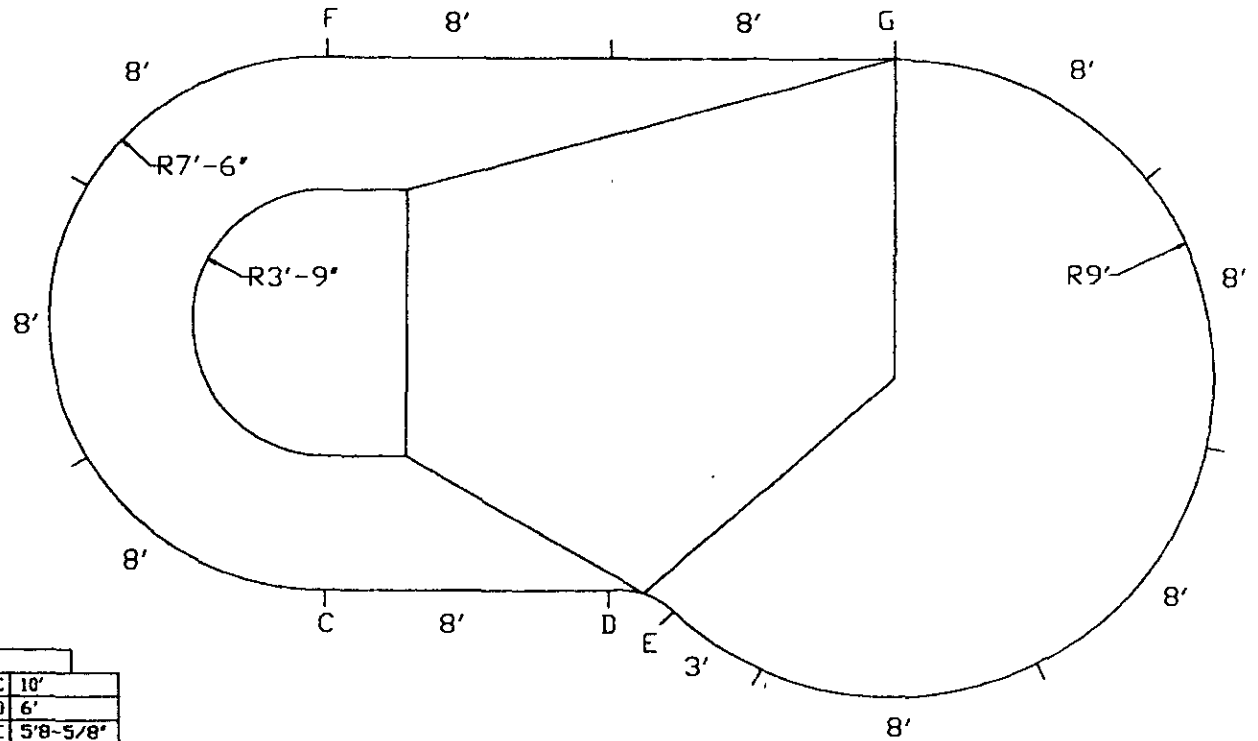
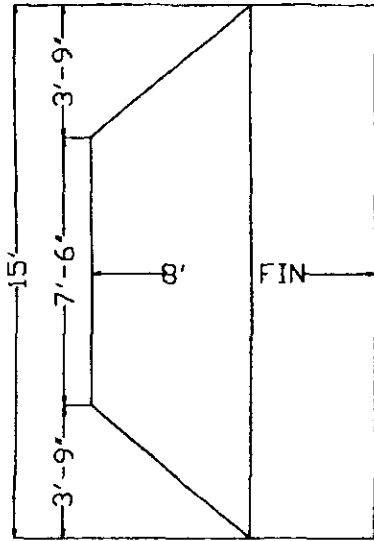

STAKE OUT			
A-C	6'-3-7/8"	B-C	10"
A-D	11'8"	B-D	6'
A-E	13'	B-E	5'-8-5/8"
A-F	21'1"	B-F	22'-5-3/4"
A-G	27'-7/8"	B-G	22'-5-3/4"

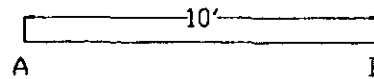

24 BAKER ST. P.O. BOX 100, HASTINGS ON KOL-1Y0
 705-696-2385, 1-800-465-3433, FAX: 705-696-1922

18'X33' NORLANDER R.H.

QTY.	LENGTH	RADIUS	TYPE
3	8'0"	9'0"	PLAIN
1	8'0"	9'0"	RETURN
1	3'0"	9'0"	PLAIN
2	8'0"	7'6"	PLAIN
1	8'0"	7'6"	RETURN
1	2'0"	2'0"	REVERSE
1	8'0"	NA	SKIMMER
2	8'0"	NA	PLAIN
12	-	NA	A-FRAME
1	-	NA	N&B PKG
			S.A.: 472.7 sq.ft
			PER: 85'
1833NORL			DATE: 15-11-00

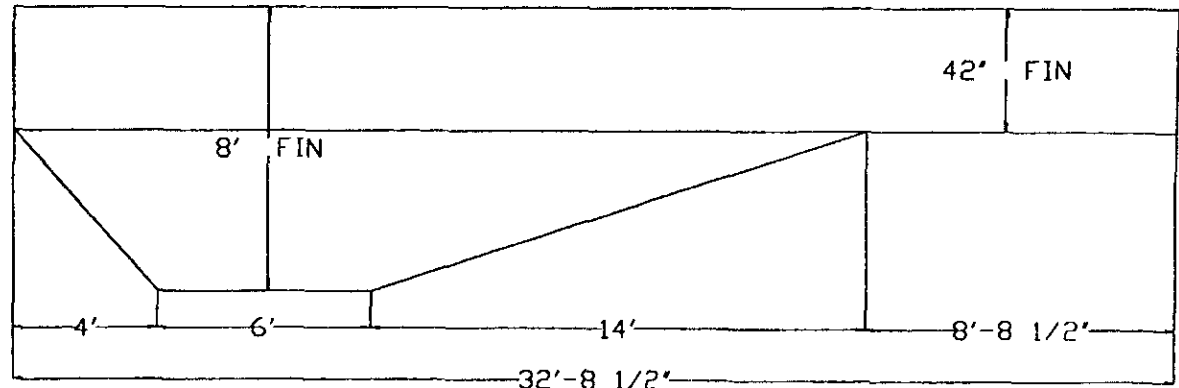

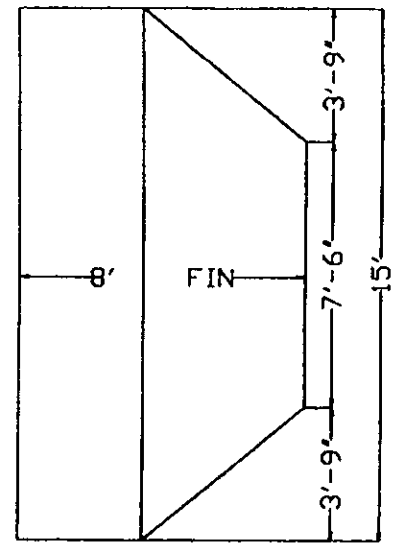
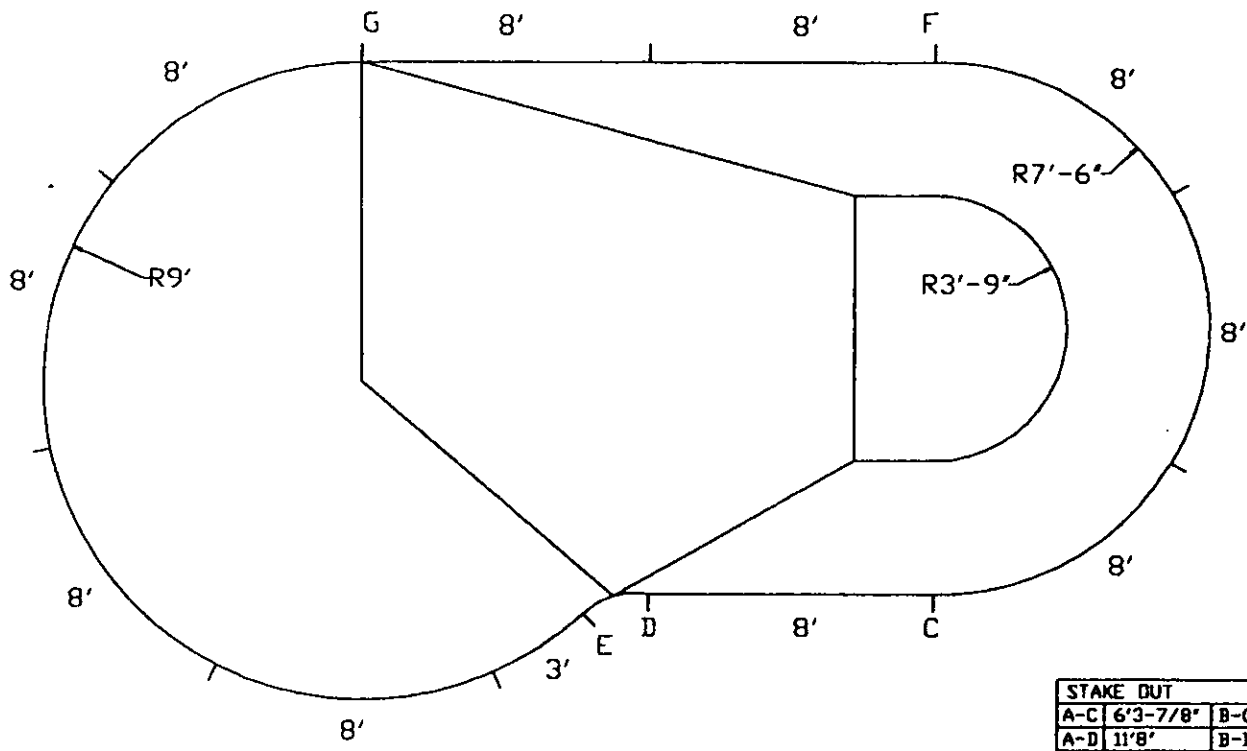

STAKE OUT			
A-C	6'3-7/8"	B-C	10'
A-D	11'8"	B-D	6'
A-E	13'	B-E	5'8-5/8"
A-F	21'1"	B-F	22'5-3/4"
A-G	27'7-7/8"	B-G	22'5-3/4"

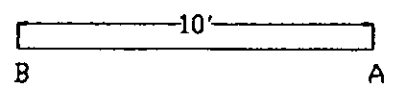

24 BAKER ST. P.O. BOX 100, HASTINGS DN, KOL-1Y0
 705-696-2385, 1-800-465-3433, FAX: 705-696-1922

18'x33' NORLANDER L.H.

QTY.	LENGTH	RADIUS	TYPE
3	8'0"	9'0"	PLAIN
1	8'0"	9'0"	RETURN
1	3'0"	9'0"	PLAIN
2	8'0"	7'6"	PLAIN
1	8'0"	7'6"	RETURN
1	2'0"	2'0"	REVERSE
1	8'0"	NA	SKIMMER
2	8'0"	NA	PLAIN

12	-	NA	A-FRAME
1	-	NA	N&B PKG
			S.A.: 472.7 sq. ft
			PER: 85'
1833NDRL			DATE: 15-11-00

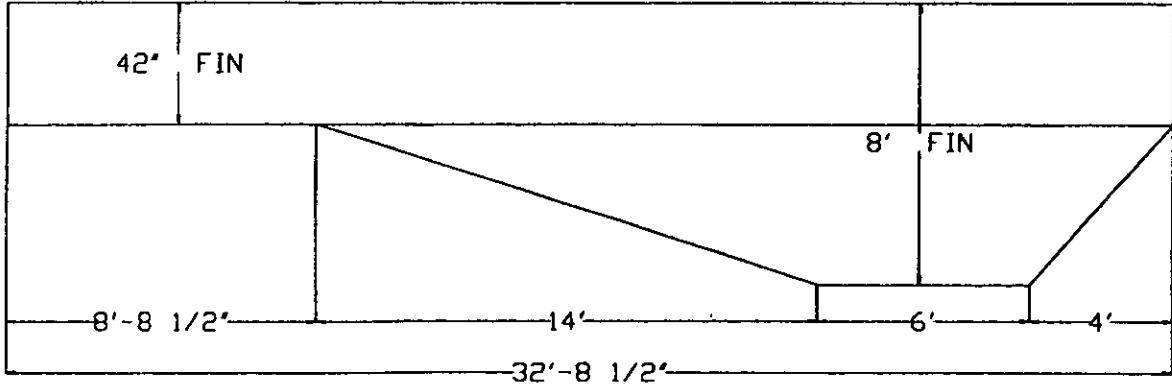

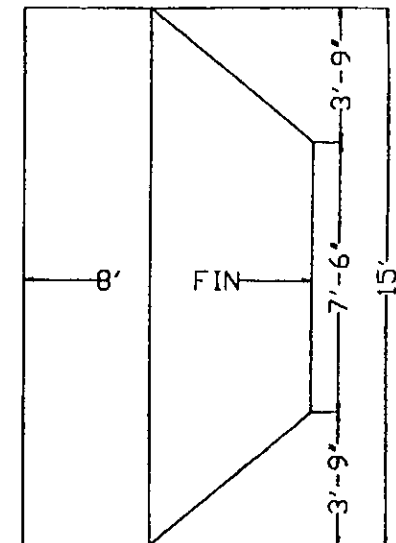
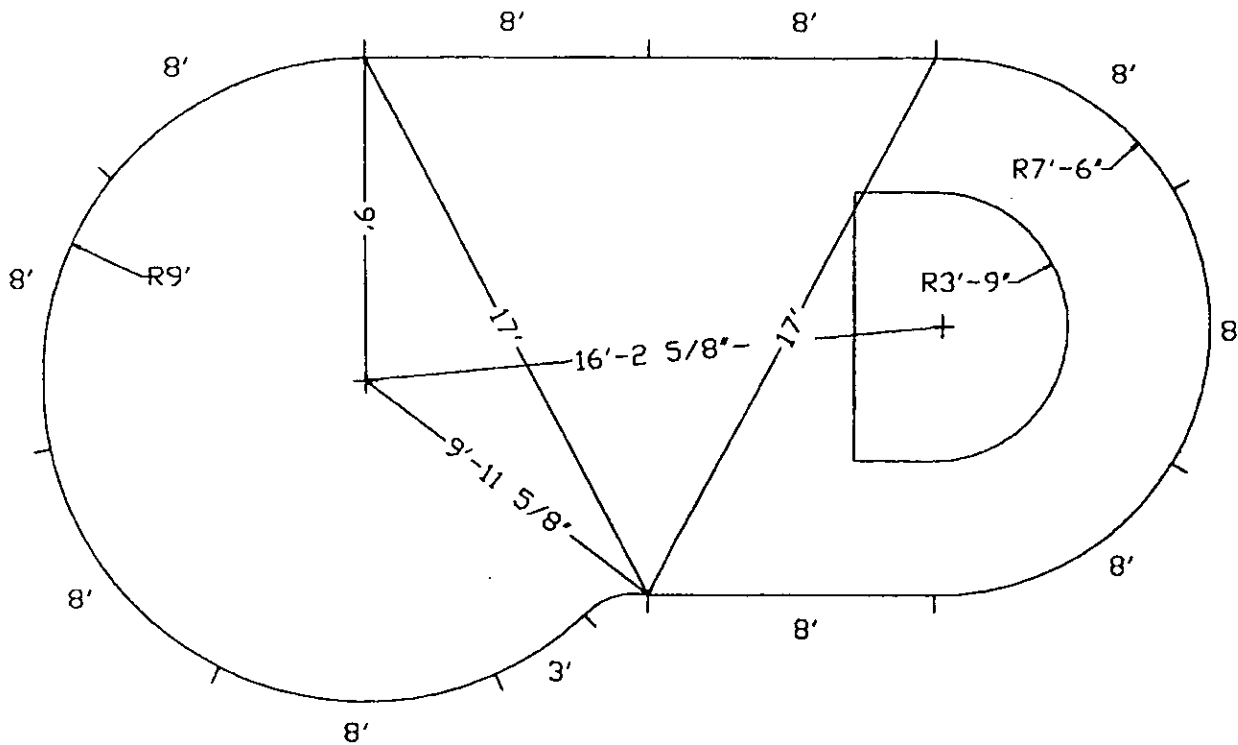

24 BAKER ST., P.O. BOX 100, HASTINGS ON KOL-1YO
705-696-2385, 1-800-465-3433, FAX 705-696-1922

18'x33' NORLANDER L.H.

QTY.	LENGTH	RADIUS	TYPE
3	8'0"	9'0"	PLAIN
1	8'0"	9'0"	RETURN
1	3'0"	9'0"	PLAIN
2	8'0"	7'6"	PLAIN
1	8'0"	7'6"	RETURN
1	2'0"	2'0"	REVERSE
1	8'0"	NA	SKIMMER
2	8'0"	NA	PLAIN

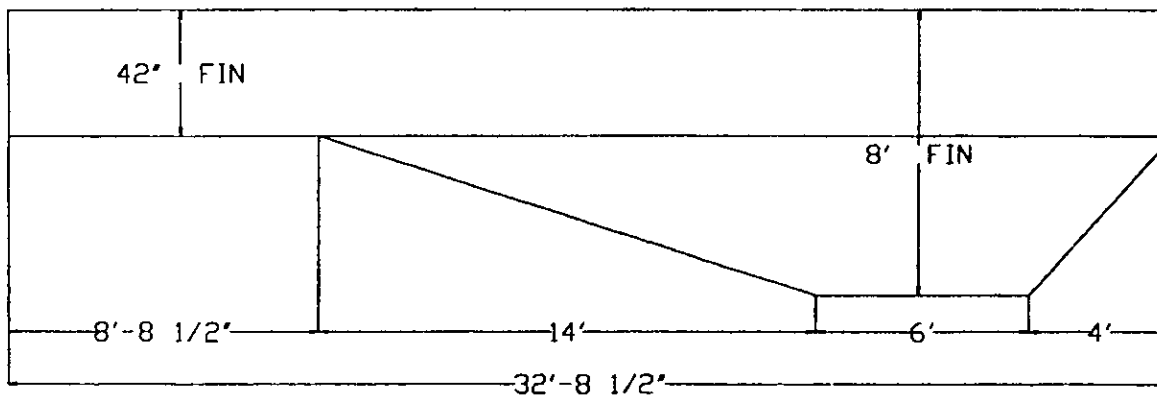

12	-	NA	A-FRAME
1	-	NA	N&B PKG
			S.A. 472.7sq.ft
			PER. 85'
1833NORL			DATE: 15-11-00

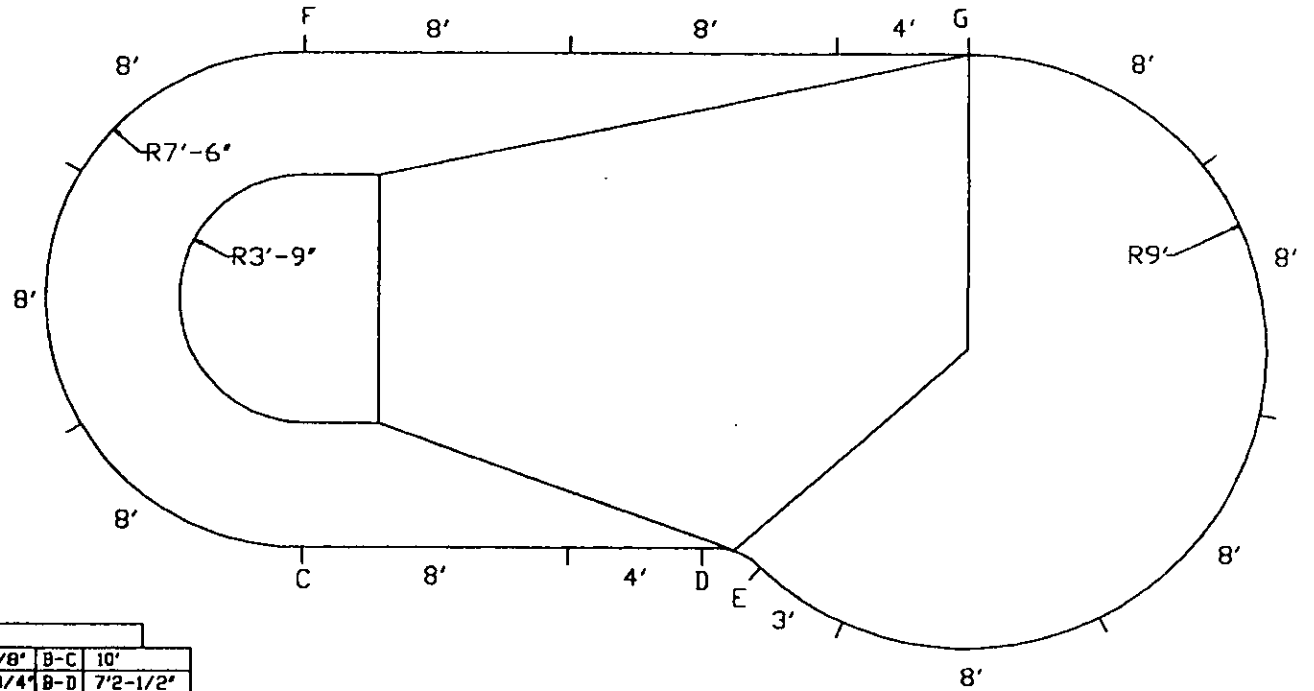
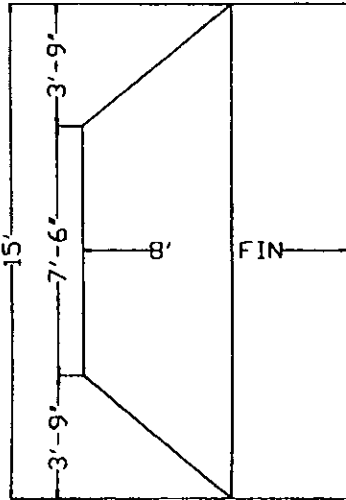

STAKE OUT			
A-C	6'3-7/8"	B-C	10'
A-D	15'2-3/4"	B-D	7'2-1/2"
A-E	16'8-3/4"	B-E	7'11-1/2"
A-F	21'1"	B-F	22'5-3/4"
A-G	30'5"	B-G	24'2-1/4"

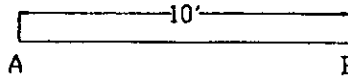

24 BAKER ST., P.O. BOX 100, HASTINGS ON KOL. - 1Y0
 705-696-2385, 1-800-465-3433, FAX: 705-696-1922

18'X37' NORLANDER R.H.

QTY.	LENGTH	RADIUS	TYPE
3	8'0"	9'0"	PLAIN
1	8'0"	9'0"	RETURN
1	3'0"	9'0"	PLAIN
2	8'0"	7'6"	PLAIN
1	8'0"	7'6"	RETURN
1	2'0"	2'0"	REVERSE
1	8'0"	NA	SKIMMER
2	8'0"	NA	PLAIN
2	4'0"	NA	PLAIN

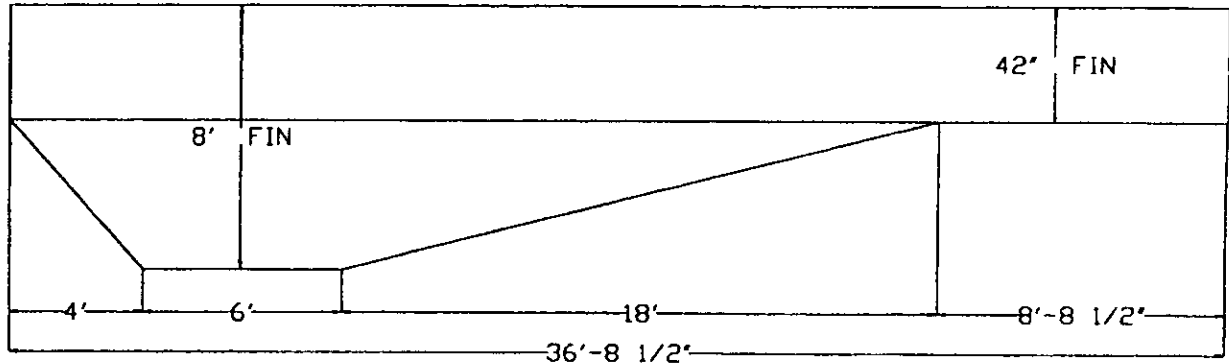

14	-	NA	A-FRAME
1	-	NA	N&B PKG
			S.A.: 532.7 sq.ft
			PER: 93'
1837NDRL			DATE: 15-11-00

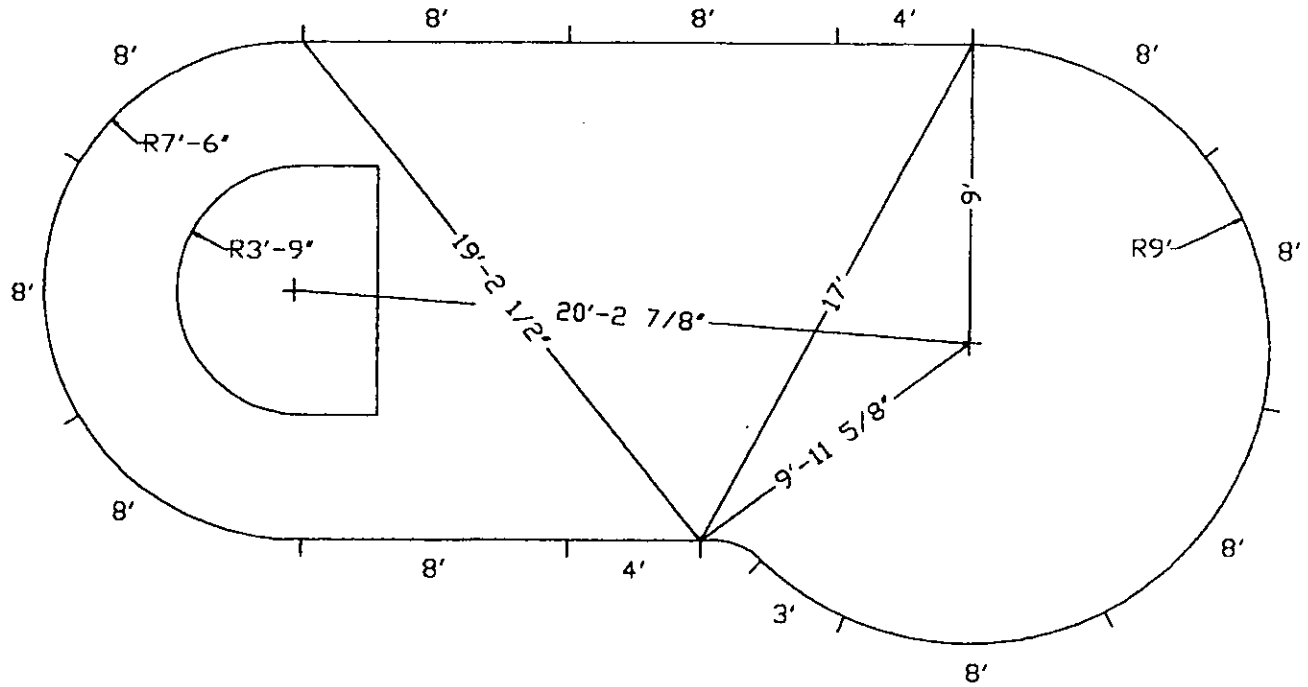
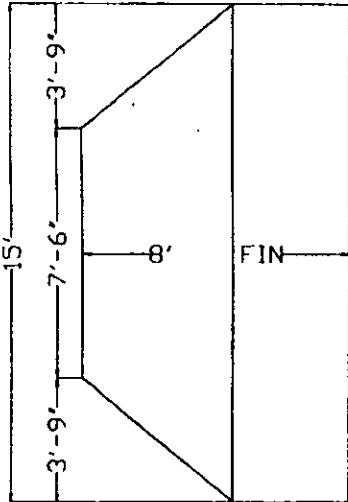

24 BAKER ST, P.O. BOX 100, HASTINGS ON KOL - IYO
 705-696-2385, 1-800-465-3433, FAX: 705-696-1922

18'X37' NORLANDER R.H.

QTY.	LENGTH	RADIUS	TYPE
3	8'0"	9'0"	PLAIN
1	8'0"	9'0"	RETURN
1	3'0"	9'0"	PLAIN
2	8'0"	7'6"	PLAIN
1	8'0"	7'6"	RETURN
1	2'0"	2'0"	REVERSE
1	8'0"	NA	SKIMMER
2	8'0"	NA	PLAIN
2	4'0"	NA	PLAIN
14	-	NA	A-FRAME
1	-	NA	N&B PKG
			S.A. 532.7 sq.ft
			PER: 93'
1837NORL			DATE: 15-11-00

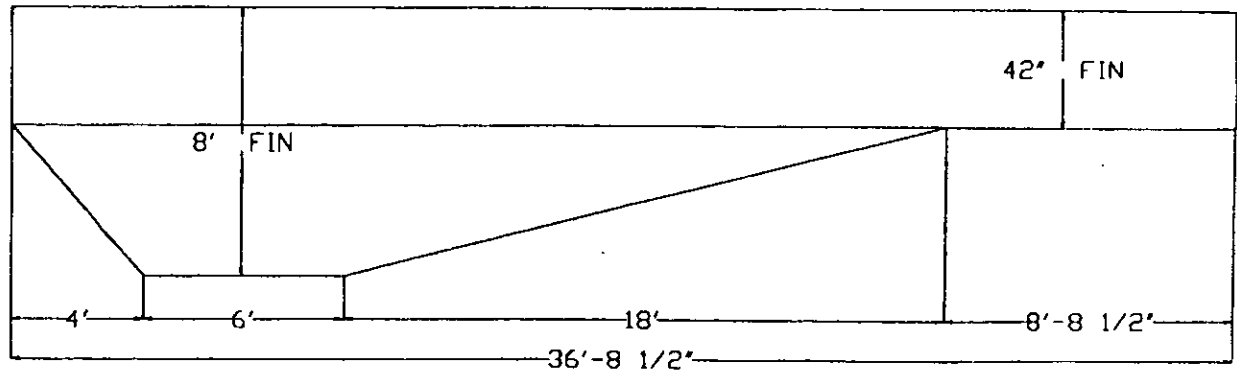

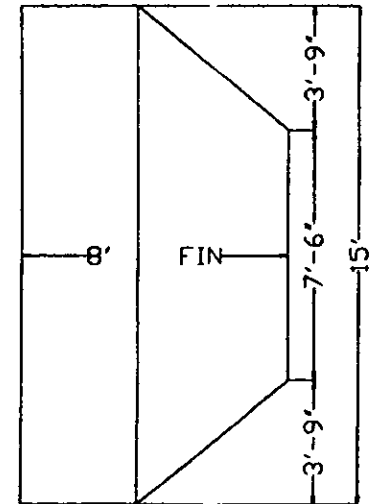
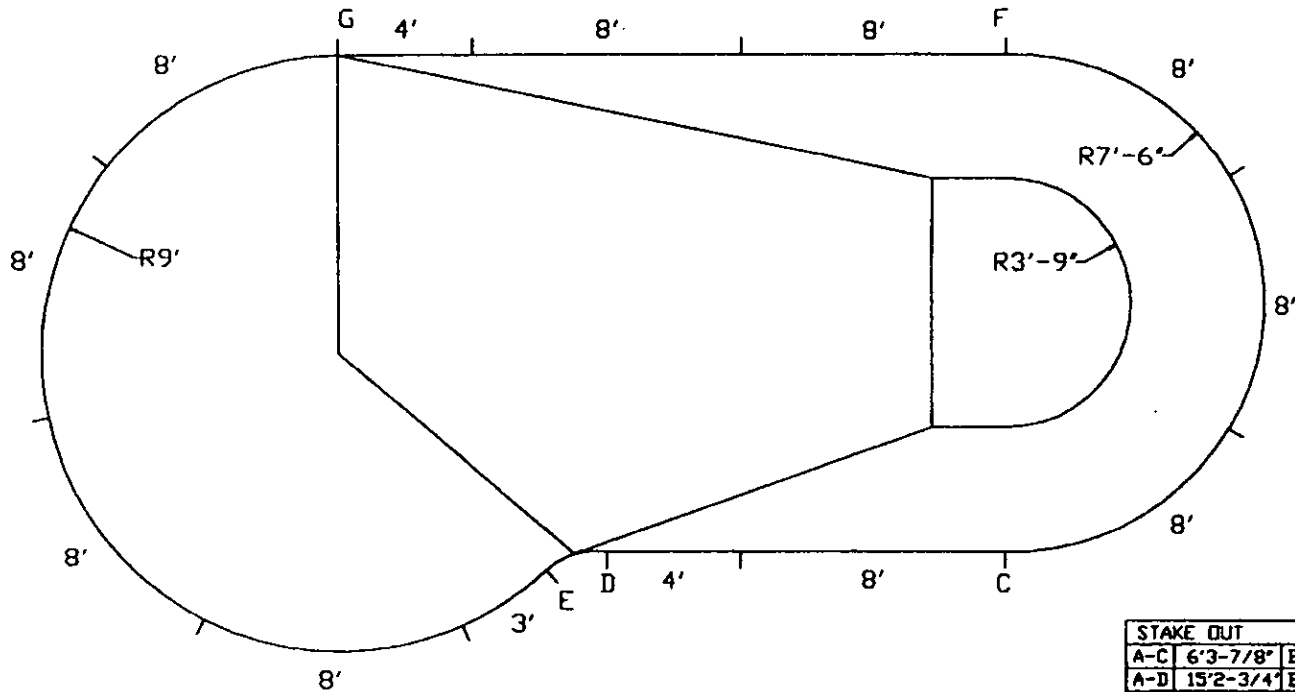

STAKE OUT			
A-C	6'3-7/8"	B-C	10'
A-D	15'2-3/4"	B-D	7'2-1/2"
A-E	16'8-3/4"	B-E	7'11-1/2"
A-F	21'1"	B-F	22'5-3/4"
A-G	30'5"	B-G	24'2-1/4"

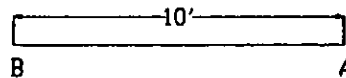

24 BAKER ST. P.O. BOX 100, HASTINGS ON KOL-1Y0
705-696-2385, 1-800-465-3433, FAX 705-696-1922

18'X37' NORLANDER L.H.

QTY.	LENGTH	RADIUS	TYPE
3	8'0"	9'0"	PLAIN
1	8'0"	9'0"	RETURN
1	3'0"	9'0"	PLAIN
2	8'0"	7'6"	PLAIN
1	8'0"	7'6"	RETURN
1	2'0"	2'0"	REVERSE
1	8'0"	NA	SKIMMER
2	8'0"	NA	PLAIN
2	4'0"	NA	PLAIN

14	-	NA	A-FRAME
1	-	NA	N&B PKG
			SA: 532.7 sq.ft
			PER: 93'
1837NORL			DATE: 15-11-00

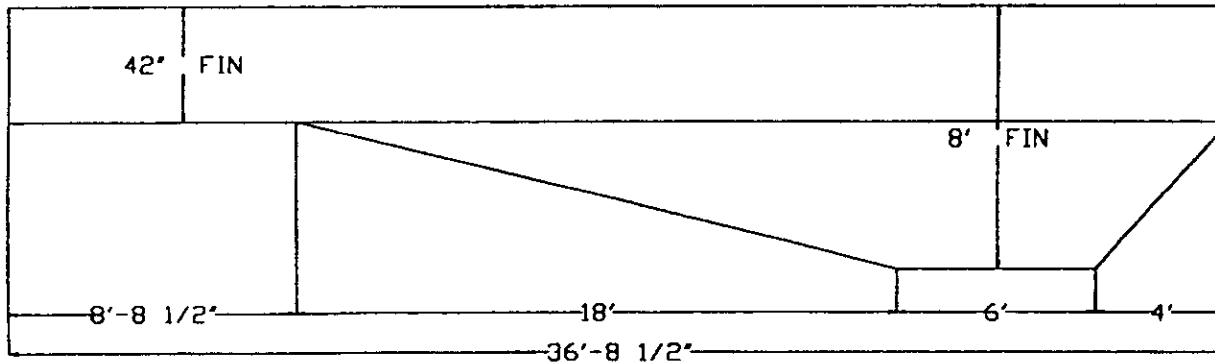

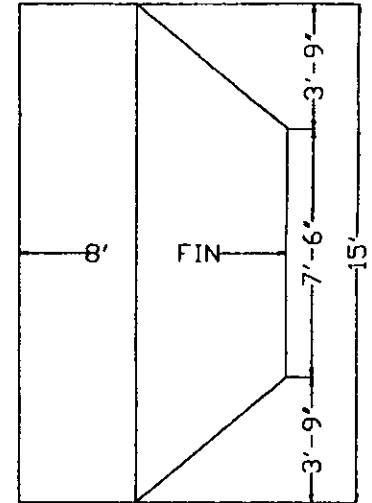
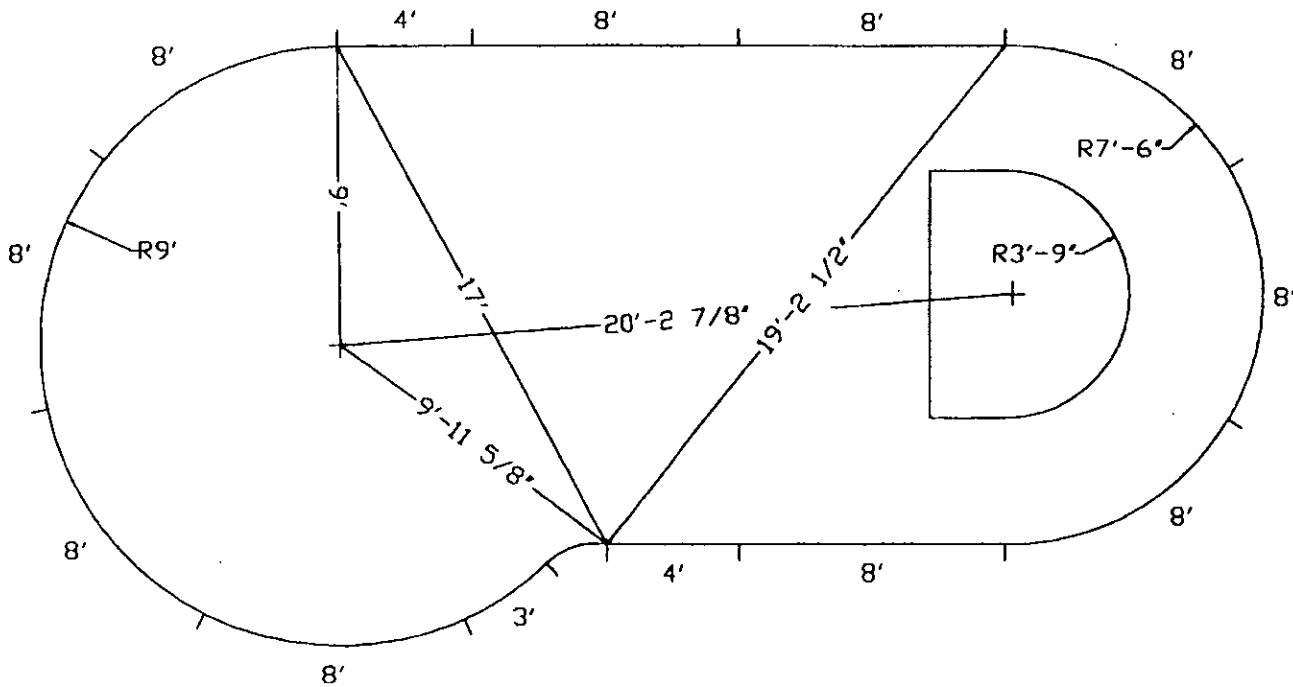

24 BAKER ST., P.O. BOX 100, HASTINGS ON KOL. 1Y0
705-696-2385, 1-800-465-3433, FAX: 705-696-1922

18'X37' NORLANDER L.H.

QTY.	LENGTH	RADIUS	TYPE
3	8'0"	9'0"	PLAIN
1	8'0"	9'0"	RETURN
1	3'0"	9'0"	PLAIN
2	8'0"	7'6"	PLAIN
1	8'0"	7'6"	RETURN
1	2'0"	2'0"	REVERSE
1	8'0"	NA	SKIMMER
2	8'0"	NA	PLAIN
2	4'0"	NA	PLAIN

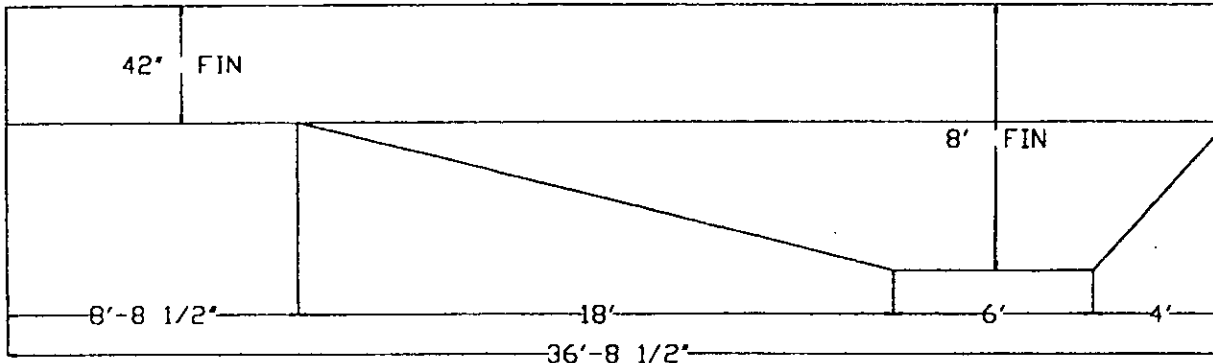

14	-	NA	A-FRAME
1	-	NA	N&B PKG
			S.A. 532.7 sq.ft
			PER. 93'
1837NORL			DATE: 15-11-00

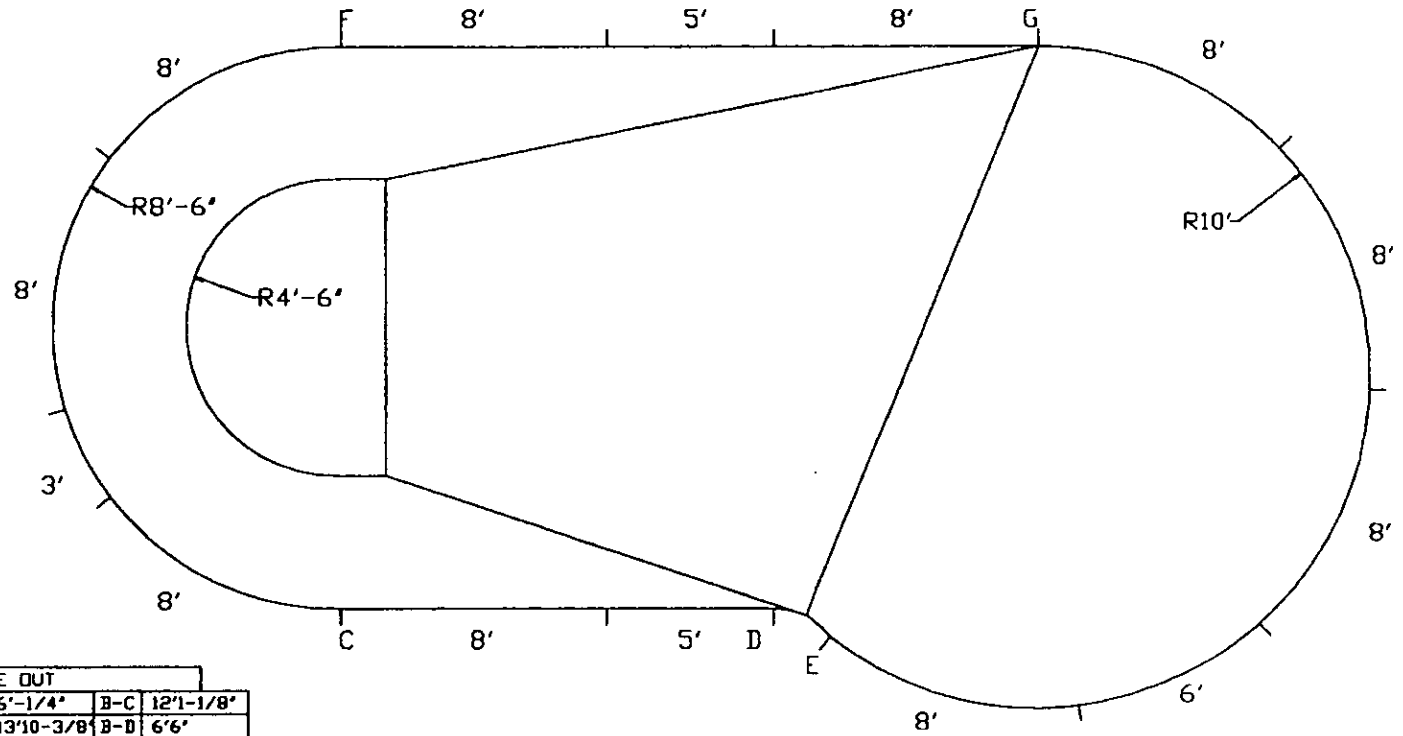
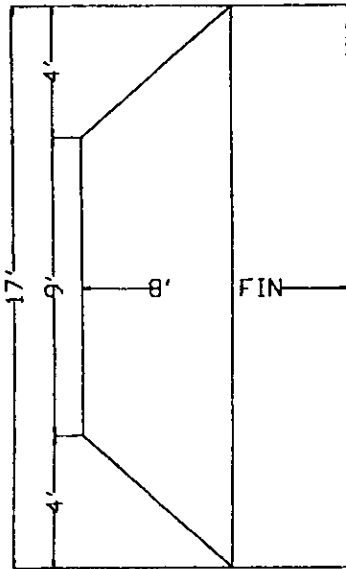

STAKE OUT			
A-C	6'-1/4"	B-C	12'-1/8"
A-D	13'-10-3/8"	B-D	6'6"
A-E	15'-3/8"	B-E	6'-3/4"
A-F	23'	B-F	25'-3-3/8"
A-G	30'-9-3/4"	B-G	25'-3-3/8"

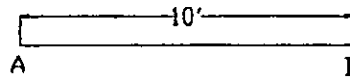

24 BAKER ST. P.O. BOX 100 HASTINGS DN. KOL-110
 705-696-2385, 1-800-465-3433, FAX: 705-696-1922

20'X40' NORLANDER R.H.

QTY.	LENGTH	RADIUS	TYPE
3	8'0"	10'0"	PLAIN
1	8'0"	10'0"	RETURN
1	6'0"	10'0"	PLAIN
2	8'0"	8'6"	PLAIN
1	8'0"	8'6"	RETURN
1	3'0"	8'6"	PLAIN
1	2'0"	2'0"	REVERSE
1	8'0"	NA	SKIMMER
2	8'0"	NA	PLAIN
2	5'0"	NA	PLAIN
15	-	NA	A-FRAME
1	-	NA	N&B PKG
			S.A. 643.22sq.ft
			PER: 101'
2040NORL	DATE: 15-11-00		

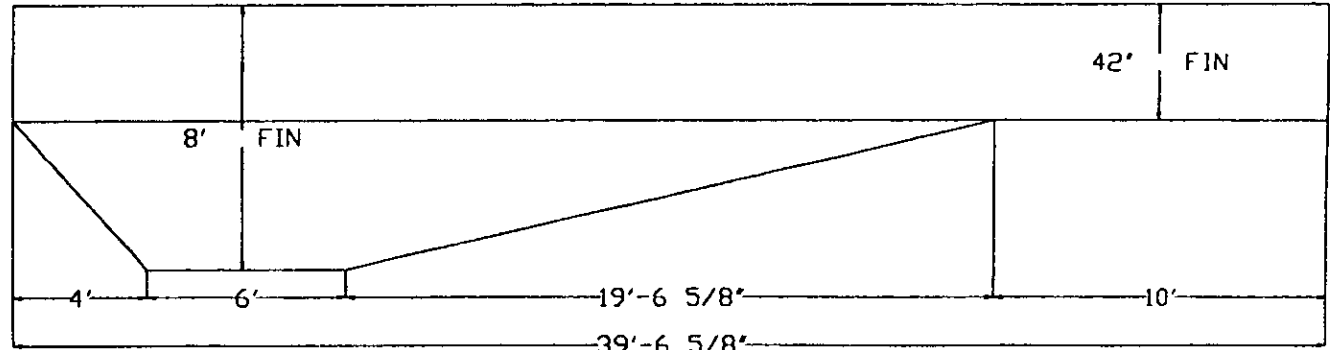

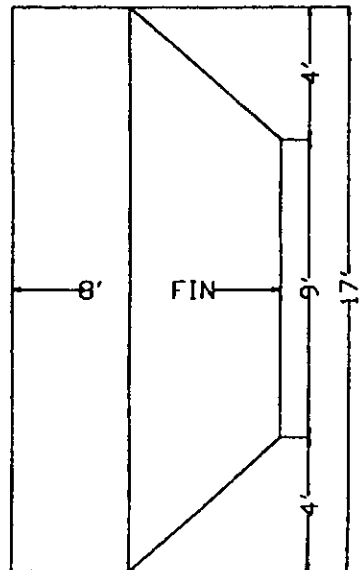
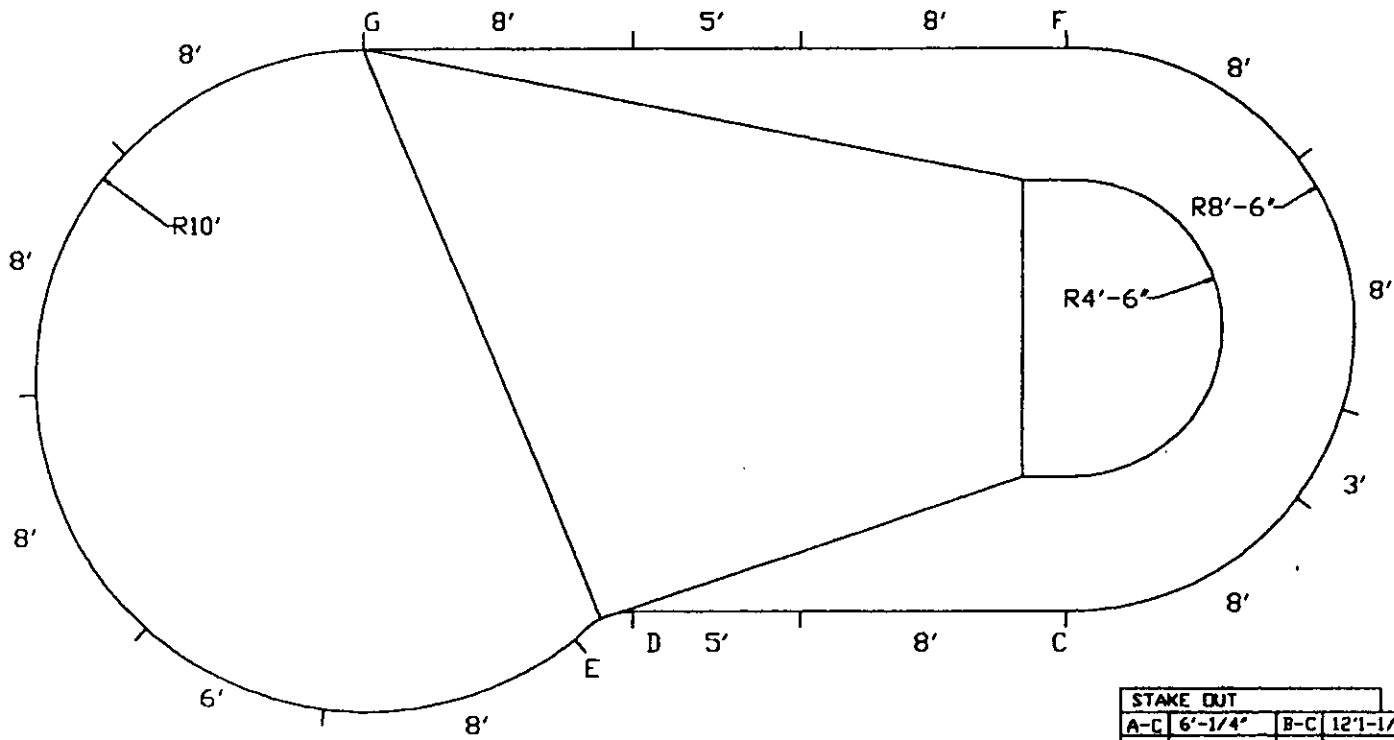

STAKE OUT			
A-C	6'-1/4"	B-C	12'-1-1/8"
A-D	13'-10-3/8"	B-D	6'6"
A-E	15'-1-3/8"	B-E	6'-7-3/4"
A-F	23'	B-F	25'-3-3/8"
A-G	30'-9-3/4"	B-G	25'-3-3/8"

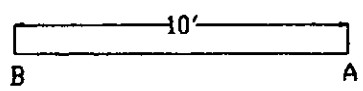

24 BAKER ST. P.O. BOX 100, HASTINGS ON KOL - 1Y0
 705-696-2385, 1-800-465-3433, FAX: 705-696-1922

20'X40' NORLANDER L.H.

QTY.	LENGTH	RADIUS	TYPE
3	8'0"	10'0"	PLAIN
1	8'0"	10'0"	RETURN
1	6'0"	10'0"	PLAIN
2	8'0"	8'6"	PLAIN
1	8'0"	8'6"	RETURN
1	3'0"	8'6"	PLAIN
1	2'0"	2'0"	REVERSE
1	8'0"	NA	SKIMMER
2	8'0"	NA	PLAIN
2	5'0"	NA	PLAIN
15	-	NA	A-FRAME
1	-	NA	N&B PKG
			S.A. 643.22sq.ft
			PER: 101'
2040NORL			DATE: 15-11-00

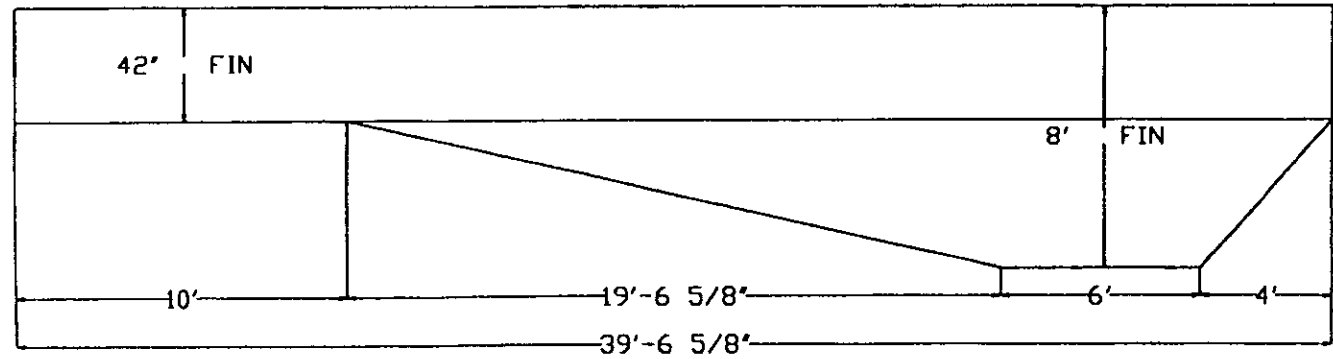

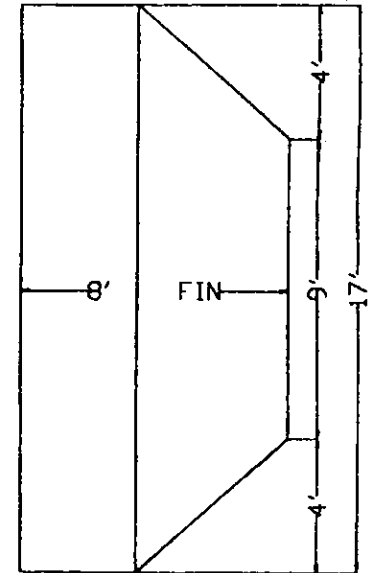
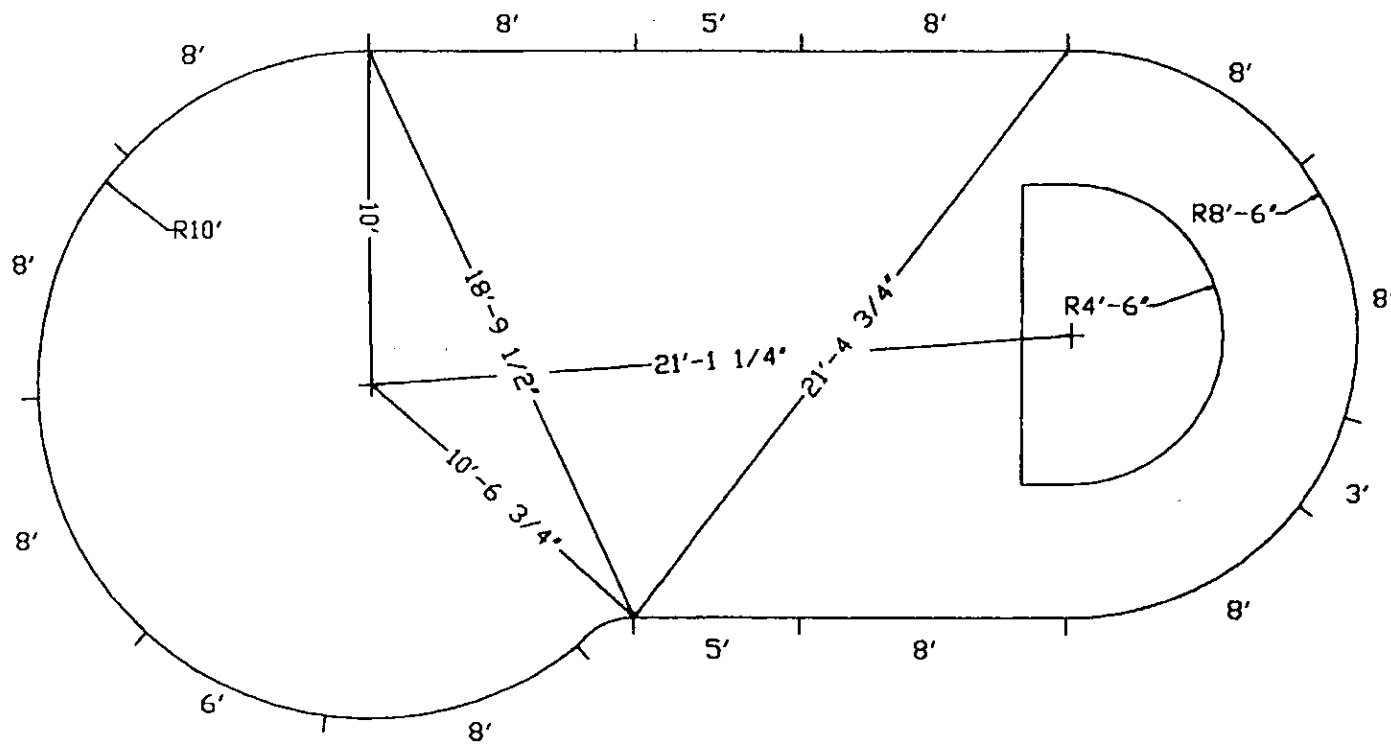

24 BAKER ST. P.O. BOX 100, HASTINGS ON KOL - 110
 705-696-2385, 1-800-465-3433, FAX: 705-696-1922

20'X40' NORLANDER L.H.

QTY.	LENGTH	RADIUS	TYPE
3	8'0"	10'0"	PLAIN
1	8'0"	10'0"	RETURN
1	6'0"	10'0"	PLAIN
2	8'0"	8'6"	PLAIN
1	8'0"	8'6"	RETURN
1	3'0"	8'6"	PLAIN
1	2'0"	2'0"	REVERSE
1	8'0"	NA	SKIMMER
2	8'0"	NA	PLAIN
2	5'0"	NA	PLAIN
15	-	NA	A-FRAME
1	-	NA	N&B PKG
			S.A.: 643.22sq.ft
			PER: 101'
2040NORL			DATE: 15-11-00

