

METRIC

HEX HEAD CAP SCREWS

Regular Pitch - Grade 8.8

- Zinc plated to protect against rust and corrosion.
- Heat treated alloy steel.
- Tensile strength 113,000 PSI min. to 142,000 PSI max.

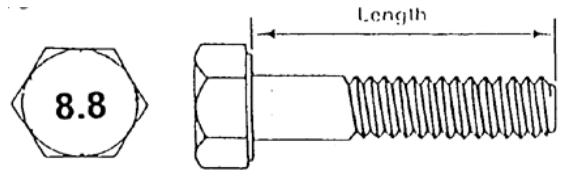

4 MM DIAMETER (7MM WRENCH)			
J&B #	SIZE	PITCH	QTY
25028	4 x 8	.70	50
5000	4 x 12	.70	50
5002	4 x 16	.70	50
5004	4 x 20	.70	50
25030	4 x 25	.70	50
25034	4 x 30	.70	50

5 MM DIAMETER (8MM WRENCH)			
J&B #	SIZE	PITCH	QTY
5006	5 x 10	.80	50
5007	5 x 12	.80	50
25029	5 x 16	.80	50
5008	5 x 20	.80	50
5010	5 x 25	.80	50
5012	5 x 30	.80	50
5014	5 x 35	.80	50
5016	5 x 40	.80	50
5018	5 x 45	.80	50
5020	5 x 50	.80	50
5270	5 x 55	.80	50
5021	5 x 60	.80	50

6 MM DIAMETER (10MM WRENCH)			
J&B #	SIZE	PITCH	QTY
5022	6 x 10	1.00	50
5023	6 x 12	1.00	50
5024	6 x 16	1.00	50
5026	6 x 20	1.00	50
5028	6 x 25	1.00	50
5030	6 x 30	1.00	50
5032	6 x 35	1.00	50
5034	6 x 40	1.00	50
5036	6 x 45	1.00	50
5038	6 x 50	1.00	50
5271	6 x 55	1.00	25
5040	6 x 60	1.00	25
5272	6 x 65	1.00	25
5042	6 x 70	1.00	25

7 MM DIAMETER (11MM WRENCH)			
J&B #	SIZE	PITCH	QTY
25031	7 x 16	1.00	50
5044	7 x 20	1.00	50
25032	7 x 25	1.00	50
5048	7 x 30	1.00	50
25033	7 x 35	1.00	50

METRIC

HEX HEAD CAP SCREWS

Regular Pitch - Grade 8.8

- Zinc plated to protect against rust and corrosion.
- Heat treated alloy steel.
- Tensile strength 113,000 PSI min. to 142,000 PSI max.

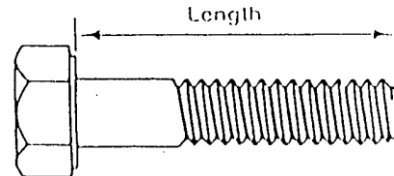

8 MM DIAMETER (13MM WRENCH)			
J&B #	SIZE	PITCH	QTY
5052	8 x 12	1.25	50
25035	8 x 16	1.25	50
5054	8 x 20	1.25	50
5056	8 x 25	1.25	50
5058	8 x 30	1.25	50
5060	8 x 35	1.25	50
5062	8 x 40	1.25	50
5064	8 x 45	1.25	50
5066	8 x 50	1.25	50
5068	8 x 60	1.25	25
5072	8 x 75	1.25	25
25036	8 x 100	1.25	25
25037	8 x 130	1.25	25

10 MM DIAMETER (17MM WRENCH)			
J&B #	SIZE	PITCH	QTY
25038	10 x 16	1.50	50
5076	10 x 20	1.50	50
25039	10 x 25	1.50	50
5078	10 x 30	1.50	25
25040	10 x 35	1.50	25
5080	10 x 40	1.50	25
25041	10 x 45	1.50	25
5082	10 x 50	1.50	25
5084	10 x 60	1.50	25
5086	10 x 70	1.50	25
25102	10 x 75	1.50	25
38449	10 x 80	1.50	25
38450	10 x 100	1.50	25
25042	10 x 110	1.50	25
25043	10 x 120	1.50	25
25099	10 x 130	1.50	25
25100	10 x 150	1.50	25

12 MM DIAMETER (19MM WRENCH)			
J&B #	SIZE	PITCH	QTY
38452	12 x 25	1.75	25
5094	12 x 30	1.75	25
25044	12 x 35	1.75	25
5096	12 x 40	1.75	25
25045	12 x 45	1.75	25
5098	12 x 50	1.75	25
5100	12 x 60	1.75	25
5102	12 x 70	1.75	25
38451	12 x 80	1.75	25
25046	12 x 100	1.75	25

14 MM DIAMETER (22MM WRENCH)			
J&B #	SIZE	PITCH	QTY
39300	14 x 25	2.00	25
39302	14 x 30	2.00	25
39304	14 x 40	2.00	25
39306	14 x 50	2.00	25
39308	14 x 60	2.00	25

16 MM DIAMETER (24MM WRENCH)			
J&B #	SIZE	PITCH	QTY
25047	16 x 30	2.00	25
25084	16 x 40	2.00	25
5134	16 x 50	2.00	25
5138	16 x 60	2.00	25
5146	16 x 80	2.00	25

18 MM DIAMETER (27MM WRENCH)			
J&B #	SIZE	PITCH	QTY
25085	18 x 40	2.50	25
25086	18 x 50	2.50	25



METRIC

HEX HEAD CAP SCREWS

Fine Thread - Grade 8.8

- Heat treated alloy steel.
- Tensile strength 113,000 PSI min. to 142,000 PSI max.

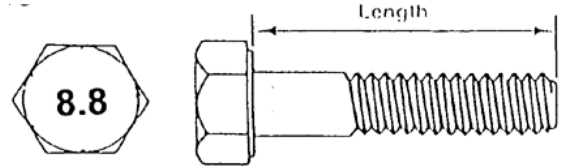

8 MM DIAMETER (13MM WRENCH)			
J&B #	SIZE	PITCH	QTY
5201	8 x 10	1.00	50
5203	8 x 20	1.00	50
5205	8 x 25	1.00	50
5207	8 x 30	1.00	50
5864	8 x 35	1.00	50
5211	8 x 40	1.00	50
5213	8 x 50	1.00	50

10 MM DIAMETER (17MM WRENCH)			
J&B #	SIZE	PITCH	QTY
5215	10 x 20	1.00	50
5219	10 x 30	1.00	25
5856	10 x 40	1.00	25
5223	10 x 50	1.00	25
5227	10 x 25	1.25	25
5229	10 x 30	1.25	25
5231	10 x 35	1.25	25
5233	10 x 40	1.25	25
5235	10 x 50	1.25	25
5237	10 x 60	1.25	25

12 MM DIAMETER (19MM WRENCH)			
J&B #	SIZE	PITCH	QTY
5239	12 x 25	1.25	25
5860	12 x 30	1.25	25
5241	12 x 35	1.25	25
5862	12 x 40	1.25	25
5243	12 x 50	1.25	25
5244	12 x 60	1.25	25
5247	12 x 30	1.50	25
5249	12 x 35	1.50	25
5251	12 x 40	1.50	25
5253	12 x 50	1.50	25
5255	12 x 60	1.50	25
5259	12 x 75	1.50	20
5261	12 x 90	1.50	15

14 MM DIAMETER (22MM WRENCH)			
J&B #	SIZE	PITCH	QTY
5265	14 x 40	1.50	10
5266	14 x 50	1.50	10
5267	14 x 60	1.50	10
5269	14 x 75	1.50	10

16 MM DIAMETER (24MM WRENCH)			
J&B #	SIZE	PITCH	QTY
39316	16 x 60	1.50	10
39319	16 x 75	1.50	10

METRIC

JIS HEX HEAD CAP SCREWS

Fine Thread - Grade 8.8

- Zinc plated, Grade 8.8.
- 17mm wrench size.



12 MM DIAMETER (17MM WRENCH)			
J&B #	SIZE	PITCH	QTY
4214	12 x 20	1.25	10
4215	12 x 25	1.25	10
4216	12 x 30	1.25	10
4217	12 x 35	1.25	10
4219	12 x 40	1.25	10
4221	12 x 50	1.25	10
4223	12 x 60	1.25	10
4225	12 x 70	1.25	10
4227	12 x 80	1.25	10
4229	12 x 90	1.25	10
4231	12 x 100	1.25	10

12 MM JIS HEX NUT			
J&B #	SIZE	WAF	QTY
4210	12-1.25	17mm	25

METRIC

HEX HEAD CAP SCREWS

Regular Pitch - Grade 10.9

- Zinc plated to protect against rust and corrosion.
- Heat treated alloy steel.
- Comparable to SAE Grade 8. 150,000 PSI Tensile Strength.

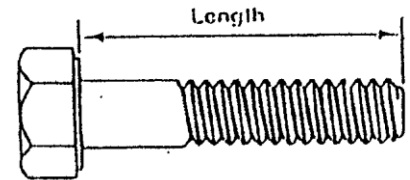

6 MM DIAMETER (10MM WRENCH)			
J&B #	SIZE	PITCH	QTY
53078	6 x 12	1.00	100
53205	6 x 16	1.00	100
53207	6 x 20	1.00	100
53208	6 x 25	1.00	100
53209	6 x 30	1.00	100
53210	6 x 35	1.00	100
53211	6 x 40	1.00	100
53212	6 x 45	1.00	50
53213	6 x 50	1.00	50
60200	6 x 55	1.00	50
53088	6 x 60	1.00	50
60201	6 x 65	1.00	50
36430	6 x 70	1.00	50
53089	6 x 80	1.00	50
60202	6 x 100	1.00	25

8 MM DIAMETER (13MM WRENCH)			
J&B #	SIZE	PITCH	QTY
53222	8 x 16	1.25	100
53223	8 x 20	1.25	100
53224	8 x 25	1.25	100
53225	8 x 30	1.25	50
53226	8 x 35	1.25	50
53227	8 x 40	1.25	50
53228	8 x 45	1.25	50
53229	8 x 50	1.25	50
53072	8 x 55	1.25	50
53230	8 x 60	1.25	50
53073	8 x 65	1.25	50
53231	8 x 70	1.25	50
53232	8 x 80	1.25	25
53233	8 x 90	1.25	25
53234	8 x 100	1.25	25
36432	8 x 120	1.25	25

10 MM DIAMETER (17MM WRENCH)			
J&B #	SIZE	PITCH	QTY
53241	10 x 16	1.50	50
53242	10 x 20	1.50	50
53243	10 x 25	1.50	50
53244	10 x 30	1.50	50
53245	10 x 35	1.50	50
53246	10 x 40	1.50	50
53247	10 x 45	1.50	50
53248	10 x 50	1.50	50
53249	10 x 55	1.50	25
53250	10 x 60	1.50	25
53251	10 x 65	1.50	25
53252	10 x 70	1.50	25
53253	10 x 75	1.50	25
53254	10 x 80	1.50	25
53255	10 x 90	1.50	25
53256	10 x 100	1.50	25
53257	10 x 120	1.50	25
36434	10 x 150	1.50	10

12 MM DIAMETER (19MM WRENCH)			
J&B #	SIZE	PITCH	QTY
53263	12 x 20	1.75	50
53264	12 x 25	1.75	50
53265	12 x 30	1.75	25
53266	12 x 35	1.75	25
53267	12 x 40	1.75	25
53268	12 x 45	1.75	25
53269	12 x 50	1.75	25
53270	12 x 55	1.75	25
53271	12 x 60	1.75	25
53272	12 x 65	1.75	25
53273	12 x 70	1.75	25
53069	12 x 75	1.75	20
53274	12 x 80	1.75	20
53275	12 x 90	1.75	15
53276	12 x 100	1.75	15
53277	12 x 110	1.75	10
53278	12 x 120	1.75	10
36436	12 x 150	1.75	10

METRIC

HEX HEAD CAP SCREWS

Regular Pitch - Grade 10.9

- Zinc plated to protect against rust and corrosion.
- Heat treated alloy steel.
- Comparable to SAE Grade 8. 150,000 PSI Tensile strength.

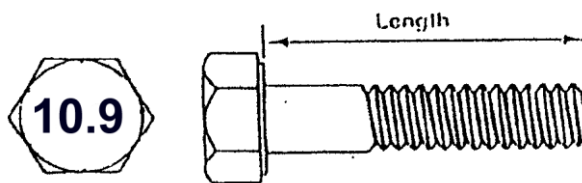

14 MM DIAMETER (22MM WRENCH)			
J&B #	SIZE	PITCH	QTY
53093	14 x 25	2.00	25
53282	14 x 30	2.00	25
53284	14 x 35	2.00	25
53286	14 x 40	2.00	25
60203	14 x 45	2.00	25
*53288	14 x 50	2.00	25
53289	14 x 55	2.00	20
53290	14 x 60	2.00	20
53079	14 x 70	2.00	15
53083	14 x 80	2.00	15
53087	14 x 90	2.00	10
53295	14 x 100	2.00	10
53117	14 x 120	2.00	10
60204	14 x 150	2.00	10

* plain finish.

18 MM DIAMETER (27MM WRENCH)			
J&B #	SIZE	PITCH	QTY
*53101	18 x 40	2.50	10
*53103	18 x 50	2.50	10
*53106	18 x 60	2.50	10
*53107	18 x 80	2.50	10
*36438	18 x 100	2.50	10
*60208	18 x 120	2.50	10
*60209	18 x 150	2.50	10

* 18 mm are plain finish.

22 MM DIAMETER (34MM WRENCH)			
J&B #	SIZE	PITCH	QTY
*57063	22 x 60	2.50	10
*57064	22 x 80	2.50	10
*57067	22 x 100	2.50	10
*57069	22 x 120	2.50	10
*60210	22 x 150	2.50	10

* 22 mm are plain finish.

16 MM DIAMETER (24MM WRENCH)			
J&B #	SIZE	PITCH	QTY
53307	16 x 30	2.00	20
53109	16 x 35	2.00	20
53308	16 x 40	2.00	20
60205	16 x 45	2.00	15
53309	16 x 50	2.00	15
60206	16 x 55	2.00	15
53310	16 x 60	2.00	15
60207	16 x 65	2.00	10
53311	16 x 70	2.00	10
53312	16 x 75	2.00	10
53313	16 x 80	2.00	10
53314	16 x 90	2.00	10
53315	16 x 100	2.00	10
53316	16 x 110	2.00	10
53317	16 x 120	2.00	10
53318	16 x 130	2.00	10
53319	16 x 140	2.00	10
53320	16 x 150	2.00	10

20 MM DIAMETER (30MM WRENCH)			
J&B #	SIZE	PITCH	QTY
53344	20 x 30	2.50	10
53346	20 x 40	2.50	10
53321	20 x 50	2.50	10
53322	20 x 60	2.50	10
53300	20 x 70	2.50	10
53350	20 x 80	2.50	10
53302	20 x 90	2.50	10
53303	20 x 100	2.50	10
53330	20 x 120	2.50	10
53354	20 x 150	2.50	10

24 MM DIAMETER (36MM WRENCH)			
J&B #	SIZE	PITCH	QTY
53336	24 x 60	3.00	10
53338	24 x 80	3.00	10
53339	24 x 100	3.00	10
53340	24 x 120	3.00	10
60211	24 x 150	3.00	10

METRIC

HEX HEAD CAP SCREWS – ISO 4017

Regular Pitch - Grade 10.9

- Bolts made with smaller width across the flats measurements (wrench sizes).
- Zinc yellow to protect against rust and corrosion.
- Heat treated alloy steel.
- Comparable to SAE Grade 8. 150,000 PSI Tensile Strength.

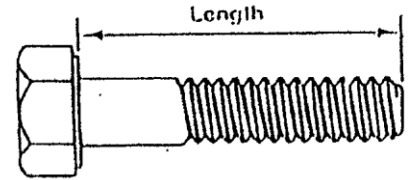

10 MM DIAMETER (16MM WRENCH)			
J&B #	SIZE	PITCH	QTY
36400	10 x 20	1.50	50
36401	10 x 25	1.50	50
36402	10 x 30	1.50	25
36403	10 x 35	1.50	25
36404	10 x 40	1.50	25
36405	10 x 45	1.50	25
36406	10 x 50	1.50	25

12 MM DIAMETER (18MM WRENCH)			
J&B #	SIZE	PITCH	QTY
36410	12 x 20	1.75	25
36411	12 x 25	1.75	25
36412	12 x 30	1.75	25
36413	12 x 35	1.75	25
36414	12 x 40	1.75	25
36415	12 x 45	1.75	25
36416	12 x 50	1.75	25

FINISHED HEX NUTS – DIN 4032

Grade 10.9 Zinc Plated

- Nuts made with smaller width across the flats measurements (wrench sizes).
- For use with property class 10.9, 9.8 and 8.8 bolts, screws and studs.

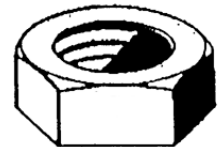

COARSE THREAD				
J&B #	SIZE	PITCH	WAF	QTY
36420	10MM	1.50	16MM	50
36421	12MM	1.75	18MM	50

METRIC

HEX FLANGE CAP SCREWS

Grade 10.9

- Heavy truck, tractor and trailer fastening system that cuts assembly, maintenance and repair costs.
- The flange bolts and flange nuts form a 150,000 p.s.i. tensile strength equivalent to G-8.
- Fastening system reduces the need for costly hole preparations such as deburring & countersinking.



FLANGE BOLTS ZINC PLATED			
J&B #	SIZE	WAF	QTY
21600	M8 x 16 x 1.25	13MM	25
21601	M8 x 20 x 1.25	13MM	25
21602	M8 x 25 x 1.25	13MM	25
21603	M8 x 30 x 1.25	13MM	25
21604	M8 x 35 x 1.25	13MM	25
21605	M8 x 40 x 1.25	13MM	10
21606	M8 x 45 x 1.25	13MM	10
21607	M8 x 50 x 1.25	13MM	10
21609	M8 x 60 x 1.25	13MM	10
21611	M8 x 70 x 1.25	13MM	10
21613	M8 x 80 x 1.25	13MM	10

FLANGE BOLTS PLAIN			
J&B #	SIZE	WAF	QTY
38867	M12 x 25 x 1.75	16MM	25
38868	M12 x 30 x 1.75	16MM	25
38869	M12 x 35 x 1.75	16MM	25
38870	M12 x 40 x 1.75	16MM	25
38889	M12 x 45 x 1.75	16MM	25
38871	M12 x 50 x 1.75	16MM	25
38872	M12 x 60 x 1.75	16MM	25
38904	M12 x 70 x 1.75	16MM	25
38877	M12 x 80 x 1.75	16MM	25
41639	M12 x 100 x 1.75	16MM	25

FLANGE BOLTS PLAIN			
J&B #	SIZE	WAF	QTY
38852	M10 x 20 x 1.50	15MM	25
38853	M10 x 25 x 1.50	15MM	25
38854	M10 x 30 x 1.50	15MM	25
38856	M10 x 35 x 1.50	15MM	25
38857	M10 x 40 x 1.50	15MM	25
38858	M10 x 45 x 1.50	15MM	25
38859	M10 x 50 x 1.50	15MM	25
38861	M10 x 60 x 1.50	15MM	25
41566	M10 x 70 x 1.50	15MM	25
38863	M10 x 80 x 1.50	15MM	25
41638	M10 x 100 x 1.50	15MM	25

FLANGE NUTS ZINC PLATED			
J&B #	SIZE	WAF	QTY
10012	M8 x 1.25	13MM	50
38851	M10 x 1.50	15MM	25
10014	M12 x 1.75	18MM	25

METRIC

HEX FLANGE CAP SCREWS Grade 10.9 – JIS Head Zinc Plated

- Heavy truck, tractor and trailer fastening system that cuts assembly, maintenance and repair costs.
- The flange bolts and flange nuts form a 150,000 p.s.i. tensile strength equivalent to G-8.
- Fastening system reduces the need for costly hole preparations such as deburring & countersinking.



FLANGE BOLTS ZINC			
J&B #	SIZE	WAF	QTY
*42399	M6-1.00 x 10	10mm	25
42400	M6-1.00 x 12	10mm	25
42401	M6-1.00 x 16	10mm	25
42402	M6-1.00 x 20	10mm	25
42403	M6-1.00 x 25	10mm	25
42404	M6-1.00 x 30	10mm	25
42405	M6-1.00 x 35	10mm	25
42406	M6-1.00 x 40	10mm	25
42407	M6-1.00 x 45	10mm	25
*42408	M6-1.00 x 50	10mm	25
*41682	M6-1.00 x 60	10mm	25

* Black Finish

FLANGE BOLTS ZINC			
J&B #	SIZE	WAF	QTY
42430	M10-1.25 x 16	14mm	25
42431	M10-1.25 x 20	14mm	25
42432	M10-1.25 x 25	14mm	25
42433	M10-1.25 x 30	14mm	25
42434	M10-1.25 x 35	14mm	20
42435	M10-1.25 x 40	14mm	15
42436	M10-1.25 x 45	14mm	15
42437	M10-1.25 x 50	14mm	15
42439	M10-1.25 x 60	14mm	10
42441	M10-1.25 x 70	14mm	10
45501	M10-1.25 x 80	14mm	10
45502	M10-1.25 x 90	14mm	10
45503	M10-1.25 x 100	14mm	10

FLANGE BOLTS ZINC			
J&B #	SIZE	WAF	QTY
42412	M8-1.25 x 12	12mm	25
42413	M8-1.25 x 16	12mm	25
42414	M8-1.25 x 20	12mm	25
42415	M8-1.25 x 25	12mm	25
42416	M8-1.25 x 30	12mm	25
42417	M8-1.25 x 35	12mm	25
42418	M8-1.25 x 40	12mm	25
42419	M8-1.25 x 45	12mm	20
42420	M8-1.25 x 50	12mm	20
42422	M8-1.25 x 60	12mm	15

FLANGE BOLTS ZINC			
J&B #	SIZE	WAF	QTY
45504	M12-1.25 x 20	17mm	25
45505	M12-1.25 x 25	17mm	25
45506	M12-1.25 x 30	17mm	20
45507	M12-1.25 x 35	17mm	15
45508	M12-1.25 x 40	17mm	10
45509	M12-1.25 x 45	17mm	10
45510	M12-1.25 x 50	17mm	10
45511	M12-1.25 x 55	17mm	10
41656	M12-1.25 x 60	17mm	10
41657	M12-1.25 x 70	17mm	10
41658	M12-1.25 x 80	17mm	10
41659	M12-1.25 x 90	17mm	10
41660	M12-1.25 x 100	17mm	10

FLANGE NUTS ZINC			
J&B #	SIZE	WAF	QTY
42446	M6-1.00	10mm	100
42447	M8-1.25	12mm	50
42448	M10-1.25	14mm	50
45514	M12-1.25	17mm	50

METRIC

ALLOY SOCKET HEAD CAP SCREWS

Regular Pitch - Class 12.9

- Cold-forged alloy steel increases strength.
- Hex is clean, deep and sharp to allow greater tightening torques.
- Exceeds Grade 8 and has a minimum tensile strength of 176,900 psi.

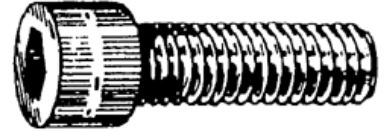

4 MM DIAMETER			
J&B #	SIZE	PITCH	QTY
25055	4 x 10	.70	50
45533	4 x 12	.70	50
45534	4 x 16	.70	50
25056	4 x 20	.70	50
45535	4 x 25	.70	50
25057	4 x 30	.70	50

5 MM DIAMETER			
J&B #	SIZE	PITCH	QTY
25058	5 x 10	.80	50
45536	5 x 12	.80	50
38406	5 x 16	.80	50
25059	5 x 20	.80	50
45541	5 x 25	.80	50
25060	5 x 30	.80	50
25093	5 x 40	.80	50
25094	5 x 50	.80	50
25095	5 x 60	.80	50
45537	5 x 70	.80	50

6 MM DIAMETER			
J&B #	SIZE	PITCH	QTY
25061	6 x 10	1.00	50
45538	6 x 12	1.00	50
38390	6 x 16	1.00	50
25062	6 x 20	1.00	50
38391	6 x 25	1.00	50
25063	6 x 30	1.00	50
25064	6 x 35	1.00	50
45539	6 x 40	1.00	50
25065	6 x 45	1.00	50
25066	6 x 50	1.00	50
25067	6 x 55	1.00	50
25068	6 x 60	1.00	50
25069	6 x 70	1.00	25
38405	6 x 80	1.00	25
25070	6 x 90	1.00	25
25071	6 x 110	1.00	25

8 MM DIAMETER			
J&B #	SIZE	PITCH	QTY
38388	8 x 12	1.25	50
38389	8 x 16	1.25	50
25072	8 x 20	1.25	50
38392	8 x 25	1.25	50
25073	8 x 30	1.25	50
38396	8 x 35	1.25	50
25074	8 x 40	1.25	50
38394	8 x 45	1.25	50
25075	8 x 50	1.25	50
38397	8 x 55	1.25	50
38393	8 x 60	1.25	50
25076	8 x 65	1.25	25
38407	8 x 70	1.25	25
38395	8 x 80	1.25	25

METRIC

ALLOY SOCKET HEAD CAP SCREWS

Regular Pitch - Class 12.9

- Cold-forged alloy steel increases strength.
- Hex is clean, deep and sharp to allow greater tightening torques.
- Exceeds Grade 8 and has a minimum tensile strength of 176,900 psi.

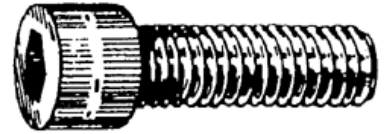

10 MM DIAMETER			
J&B #	SIZE	PITCH	QTY
25088	10 x 20	1.50	25
45540	10 x 25	1.50	25
25077	10 x 30	1.50	25
38398	10 x 35	1.50	25
25078	10 x 40	1.50	25
38399	10 x 45	1.50	25
25079	10 x 50	1.50	25
38402	10 x 55	1.50	25
25080	10 x 60	1.50	25
45542	10 x 80	1.50	25
57073	10 x 100	1.50	25
57074	10 x 120	1.50	25

12 MM DIAMETER			
J&B #	SIZE	PITCH	QTY
45543	12 x 20	1.75	25
38410	12 x 25	1.75	25
25090	12 x 30	1.75	25
38411	12 x 35	1.75	25
45544	12 x 40	1.75	25
38412	12 x 45	1.75	25
25081	12 x 50	1.75	25
38413	12 x 55	1.75	25
25096	12 x 60	1.75	25
38118	12 x 70	1.75	25
45546	12 x 80	1.75	25
57076	12 x 100	1.75	25
57077	12 x 120	1.75	25

14 MM DIAMETER			
J&B #	SIZE	PITCH	QTY
38120	14 x 50	2.00	25
57079	14 x 60	2.00	25
57080	14 x 80	2.00	25

16 MM DIAMETER			
J&B #	SIZE	PITCH	QTY
45560	16 x 30	2.00	25
45561	16 x 40	2.00	25
45562	16 x 50	2.00	25
45563	16 x 60	2.00	25
45565	16 x 80	2.00	25
57082	16 x 100	2.00	25
57083	16 x 120	2.00	25

18 MM DIAMETER			
J&B #	SIZE	PITCH	QTY
57085	18 x 60	2.50	25
57087	18 x 80	2.50	25
57089	18 x 100	2.50	25

20 MM DIAMETER			
J&B #	SIZE	PITCH	QTY
25082	20 x 60	2.50	25
25083	20 x 100	2.50	25

METRIC

FLAT HEAD SOCKET CAP SCREWS

Regular Pitch – Class 12.9

- Alloy steel heat treated
- Threads are close fitting to resist loosening under vibration.
- Centered and trimmed socket and head for better seating and better balanced wrenching.
- 180,000 PSI tensile strength thru 1/2", 170,000 PSI tensile strength over 1/2".

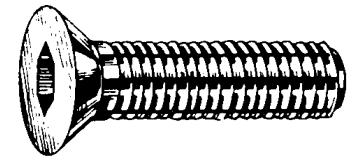

3 MM DIAMETER			
J&B #	SIZE	PITCH	QTY
39342	3 x 6	.50	100

4 MM DIAMETER			
J&B #	SIZE	PITCH	QTY
39344	4 x 6	.70	100
39345	4 x 10	.70	100
39346	4 x 12	.70	100

5 MM DIAMETER			
J&B #	SIZE	PITCH	QTY
39362	5 x 8	.80	100
39363	5 x 12	.80	100
39364	5 x 16	.80	100

6 MM DIAMETER			
J&B #	SIZE	PITCH	QTY
39367	6 x 8	1.00	100
39368	6 x 12	1.00	100
39369	6 x 16	1.00	100
39370	6 x 20	1.00	100
39371	6 x 25	1.00	100

8 MM DIAMETER			
J&B #	SIZE	PITCH	QTY
39374	8 x 20	1.25	50
39375	8 x 25	1.25	50
39376	8 x 30	1.25	50
39377	8 x 35	1.25	50
39378	8 x 40	1.25	50

10 MM DIAMETER			
J&B #	SIZE	PITCH	QTY
39392	10 x 20	1.50	50
39393	10 x 25	1.50	50
39394	10 x 30	1.50	50
39395	10 x 40	1.50	50
39396	10 x 50	1.50	50

12 MM DIAMETER			
J&B #	SIZE	PITCH	QTY
39324	12 x 20	1.75	25
39325	12 x 25	1.75	25
39326	12 x 30	1.75	25
39327	12 x 40	1.75	25
39328	12 x 50	1.75	25

METRIC

ALLOY SOCKET SET SCREWS

Cup Point
Din 916 – Grade 12.9



- Precision rolled threads for greater holding power & accurate size.
- Greater resistance to snapping, stretching and shearing.
- Strong, full finished deep socket allows full wrenching leverage.

3MM DIAMETER		
J&B #	SIZE	QTY
87010	3mm - .50 x 6	100
87011	3mm - .50 x 8	100

4MM DIAMETER		
J&B #	SIZE	QTY
87012	4mm - .70 x 6	100
36936	4mm - .70 x 8	100
87013	4mm - .70 x 10	100

5MM DIAMETER		
J&B #	SIZE	QTY
36940	5mm - .80 x 8	100
36941	5mm - .80 x 10	100
87014	5mm - .80 x 12	100
36943	5mm - .80 x 16	100

6MM DIAMETER		
J&B #	SIZE	QTY
36946	6mm x 1.00 x 8	100
36947	6mm x 1.00 x 10	100
87015	6mm x 1.00 x 12	100
36949	6mm x 1.00 x 16	100

8MM DIAMETER		
J&B #	SIZE	QTY
87016	8mm x 1.25 x 8	50
36952	8mm x 1.25 x 10	50
36954	8mm x 1.25 x 16	50
36955	8mm x 1.25 x 20	50
36956	8mm x 1.25 x 25	50

10MM DIAMETER		
J&B #	SIZE	QTY
87017	10mm x 1.50 x 12	50
36960	10mm x 1.50 x 16	50
36961	10mm x 1.50 x 20	50
36963	10mm x 1.50 x 30	25

METRIC

FINISHED HEX NUTS

Zinc Plated

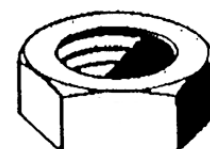

- Most used general purpose nut.

COARSE THREAD			
J&B #	SIZE	PITCH	QTY
87050	2MM	.40	100
87051	2.5MM	.45	100
5600	3MM	.50	50
87052	3.5MM	.60	100
5602	4MM	.70	100
5604	5MM	.80	100
5606	6MM	1.00	100
5608	7MM	1.00	50
5610	8MM	1.25	50
5612	10MM	1.50	50
5614	12MM	1.75	25
5616	14MM	2.00	25
5618	16MM	2.00	10
5617	18MM	2.50	10
5619	20MM	2.50	10
5620	22MM	2.50	10
5621	24MM	3.00	10

FINE THREAD			
J&B #	SIZE	PITCH	QTY
5701	8MM	1.00	50
5703	10MM	1.00	50
5705	10MM	1.25	50
5707	12MM	1.25	50
5709	12MM	1.50	50
5711	14MM	1.50	25
39314	16MM	1.50	20
* 38447	18MM	1.50	10
* 38448	20MM	1.50	10

* PLAIN FINISH

FINISHED HEX NUTS

Grade 10.9 Zinc Plated

- For use with property class 10.9, 9.8 and 8.8 bolts, screws and studs.



COARSE THREAD			
J&B #	SIZE	PITCH	QTY
53108	6MM	1.00	100
53110	8MM	1.25	100
53111	10MM	1.50	100
53112	12MM	1.75	50
53113	14MM	2.00	50
53114	16MM	2.00	25
53074	18MM	2.50	25
53116	20MM	2.50	25
60055	22MM	2.50	25
53332	24MM	3.00	25

METRIC

NYLON INSERT LOCK NUTS

Zinc Plated

- Vibration and shock-proof - provides 100% lock up to 250° F.
- Fully re-usable....leak-proof seal against water, grease, corrosion.
- Won't damage bolt threads.

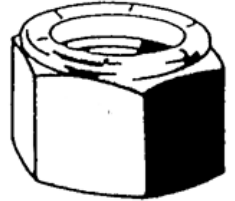

J&B #	SIZE	PITCH	QTY
41866	4MM	.70	50
41873	5MM	.80	50
5622	6MM	1.00	50
42198	7MM	1.00	50
42192	8MM	1.00	50
5624	8MM	1.25	50
42193	10MM	1.00	25
41837	10MM	1.25	25
5626	10MM	1.50	25
42194	12MM	1.25	25
42195	12MM	1.50	25
5628	12MM	1.75	25
42196	14MM	1.50	25
41862	14MM	2.00	25
42197	16MM	1.50	25
41863	16MM	2.00	25
53075	18MM	2.50	10
5855	20MM	1.50	10
41864	20MM	2.50	10

NYLON INSERT LOCK NUTS

10.9

Zinc Plated

Zinc Plated COARSE THREAD			
J&B #	SIZE	PITCH	QTY
21590	6MM	1.00	50
21591	8MM	1.25	50
21592	10MM	1.50	25
21593	12MM	1.75	25
21595	16MM	2.00	25

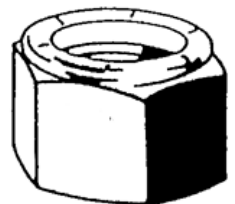

METRIC

STOVER LOCKNUTS

Zinc Plated

COARSE THREAD			
J&B #	SIZE	PITCH	QTY
41831	6MM	1.00	50
41832	8MM	1.25	50
41833	10MM	1.50	25
41834	12MM	1.75	25
41835	14MM	2.00	25
41836	16MM	2.00	10
53076	18MM	2.50	10
41838	20MM	2.50	10
39320	22MM	2.50	10
39321	24MM	3.00	10

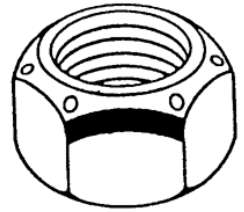

- Din 980: Class 8

ROD COUPLING NUTS

- Fully threaded nuts used with threaded rod, leveling feet, spacing and jig fixtures.
- Also known as extension nuts and can be used to join two or more studs for a desired length.
- Plated finish protects against rust and corrosion.

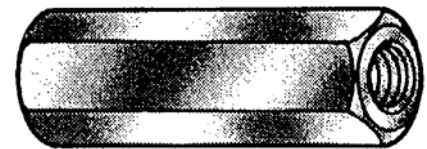

J&B #	SIZE	QTY
45611	6MM-1.00	25
45612	8MM-1.25	25
45613	10MM-1.50	25
45614	12MM-1.75	10

WING NUTS

- Plated finish protects against rust and corrosion.
- Permit rapid assembly and disassembly by hand.
- Make fine adjustments in the field.



J&B #	SIZE	QTY
46080	6MM-1.00	25
46081	8MM-1.25	25
46082	10MM-1.50	25

METRIC

FLANGE NUTS

Grade 10.9 Zinc Plated

- Nuts have a smooth finish on the bottom (no serrations).

J&B#	SIZE	PITCH	WAF	FLANGE O.D.	QTY
^45736	4MM	0.70	7	11	50
45737	5MM	0.80	8	11.5	50
10010	6MM	1.00	10	14	50
10012	8MM	1.25	13	17	50
38851	10MM	1.50	15	20	25
*10013	12MM	1.25	18	25	25
10014	12MM	1.75	18	25	25
*10016	14MM	2.00	20	29	25
10017	16MM	2.00	22	33	10
10018	20MM	2.50	30	42	10



^45736 is Black zinc

*10013 & 10016 are Grade 8.8

FLANGE NUTS

Grade 10.9 Zinc Plated JIS Head

- Nuts have a smooth finish on the bottom (no serrations).

J&B#	SIZE	PITCH	WAF	FLANGE O.D.	QTY
42446	6MM	1.00	10	13	100
42447	8MM	1.25	12	17	50
42448	10MM	1.25	14	19	50
45514	12MM	1.25	17	25	50



FLANGE NUTS

Phosphate

- Nuts have a smooth finish on the bottom (no serrations).

J&B#	SIZE	PITCH	WAF	FLANGE O.D.	QTY
42060	8MM	1.25	13	17	25
45804	10MM	1.50	15	21	25
45582	12MM	1.75	18	25	25



SPIN LOCK NUTS WITH SERRATIONS

Zinc Plated Case Hardened

J&B#	SIZE	PITCH	WAF	FLANGE O.D.	QTY
45738	6MM	1.00	10	14	50
40932	8MM	1.25	12	17	50
45852	10MM	1.25	14	19	25



METRIC

FLAT WASHERS

Zinc Plated

J&B #	SIZE	QTY
87060	2MM	100
87061	2.5MM	100
41867	3MM	100
87062	3.5MM	100
5820	4MM	100
5822	5MM	100
5824	6MM	100
5826	7MM	100
5828	8MM	100
5830	10MM	100
5832	12MM	50
5834	14MM	50
5836	16MM	50
5838	18MM	50
5840	20MM	50
60065	22MM	25



- Burr-free - uniform thickness.

FLAT WASHERS

10.9 Zinc Plated

J&B #	SIZE	QTY
53128	6MM	100
53130	8MM	100
53131	10MM	100
53132	12MM	50
53133	14MM	50
53134	16MM	25
53077	18MM	25
53136	20MM	25
53333	24MM	25



- For use with 12.9, 10.9, 9.8 and 8.8 property class fasteners.

HIGH COLLAR LOCK WASHERS

(Used with Hex Socket Cap Screws)

- Springs back to normal position without loss of locking power.

J&B #	SIZE	QTY
25140	5MM	100
25141	6MM	100
25142	8MM	50
25143	10MM	50
25144	12MM	50



METRIC

FENDER WASHERS Zinc Plated

- Specifically designed for application where a larger bearing is required.
- Smooth surface; free from burrs.
- **Uniform** thickness.

J&B #	I. D.	O. D.	QTY
46766	4	12	100
46768	5	15	100
46770	6	20	100
46773	8	24	50
46777	10	30	50

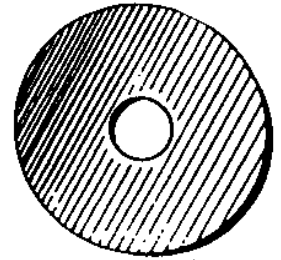

HELICAL SPRING LOCK WASHERS Zinc Plated

- Add strength and insure against equipment breakdown; non-linking, positive locking.
- For use with 12.9, 10.9 and 8.8 fasteners.

J&B #	SIZE	QTY
87055	2MM	100
87056	2.5MM	100
41869	3MM	100
5800	4MM	100
87057	3.5MM	100
5802	5MM	100
5804	6MM	100
5806	7MM	100
5808	8MM	100
5810	10MM	100
5812	12MM	100
5814	14MM	100
5816	16MM	50
5818	18MM	50
5819	20MM	50
60068	22MM	25
25023	24MM	25



SPRING WASHERS Plain Finish

J&B #	SIZE	QTY
5842	4MM	100
5844	5MM	100
5846	6MM	100
5848	7MM	100
5850	8MM	100
5852	10MM	100
5854	12MM	100



METRIC

MACHINE SCREWS

Phillips Pan Head
Zinc Plated

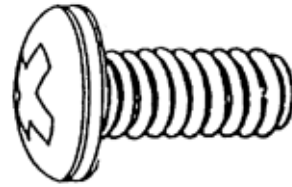

- Plated finish protects against rust and corrosion.
- Fully threaded and free from burrs.

2 MM DIAMETER		
J&B #	SIZE	QTY
87030	2mm - .40 x 4	100
87031	2mm - .40 x 6	100
87032	2mm - .40 x 8	100
87033	2mm - .40 x 10	100

2.5 MM DIAMETER		
J&B #	SIZE	QTY
87036	2.5mm - .45 x 4	100
87037	2.5mm - .45 x 6	100
87038	2.5mm - .45 x 8	100
87039	2.5mm - .45 x 10	100

3 MM DIAMETER		
J&B #	SIZE	QTY
36900	3mm - .50 x 6	100
36901	3mm - .50 x 8	100
36902	3mm - .50 x 10	100
36903	3mm - .50 x 12	100
36904	3mm - .50 x 16	100
36905	3mm - .50 x 20	100

3.5 MM DIAMETER		
J&B #	SIZE	QTY
87042	3.5mm - .60 x 6	100
87043	3.5mm - .60 x 8	100
87044	3.5mm - .60 x 10	100
87045	3.5mm - .60 x 12	100
87046	3.5mm - .60 x 16	100
87047	3.5mm - .60 x 20	100

4 MM DIAMETER		
J&B #	SIZE	QTY
36908	4mm - .70 x 6	100
36909	4mm - .70 x 8	100
36910	4mm - .70 x 10	100
36911	4mm - .70 x 12	100
36912	4mm - .70 x 16	100
36913	4mm - .70 x 20	100
36914	4mm - .70 x 25	100

5 MM DIAMETER		
J&B #	SIZE	QTY
36915	5mm - .80 x 8	100
36916	5mm - .80 x 10	100
36917	5mm - .80 x 12	100
36918	5mm - .80 x 16	100
36919	5mm - .80 x 20	100
36920	5mm - .80 x 25	100

6 MM DIAMETER		
J&B #	SIZE	QTY
36923	6mm - 1.00 x 8	100
36924	6mm - 1.00 x 10	100
36925	6mm - 1.00 x 12	100
36926	6mm - 1.00 x 16	100
11120	6mm - 1.00 x 20	100
36928	6mm - 1.00 x 25	100
36929	6mm - 1.00 x 30	100

METRIC

HEX KEYS

- Heat treated alloy steel - key is tough and ductile clear through.
- Accurately sized to ensure full wall contact.
- Square cut and engages the socket full depth for better tightening of screw.



J&B #	SIZE	FOR USE WITH:			QTY
		SOCKET HEAD CAP SCREWS	FLAT HEAD SOCKET CAP SCREWS	SOCKET HEAD SET SCREWS	
11190	3MM	M4	M5	M6	EA
11191	4MM	M5	M6	M8	EA
11192	5MM	M6	M8	M10	EA
11193	6MM	M8	M10	M12	EA
11194	8MM	M10	M12	M16	EA
11195	10MM	M12	M16	M20	EA
11196	12MM	M14	M20	M24	EA
11197	14MM	M16	M24		EA
11198	17MM	M20			EA

BALL HEX KEY SET

- 9 KEYS; 1.5MM thru 10MM.

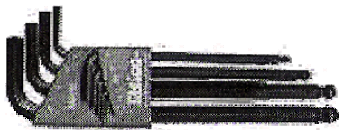

J&B #	QTY
R28704	EA

FOLD-UP KEY SET

- 8 KEYS; 1.5MM thru 8MM.

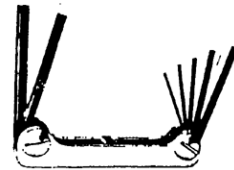

J&B #	QTY
11200	EA

MINIATURE METRIC SLIDE CALIPER

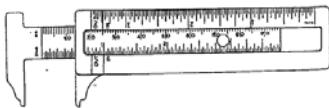

J&B #	QTY
11202	EA

METRIC THREAD PITCH GAUGE

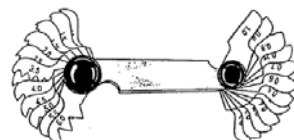

J&B #	QTY
11201	EA

STUDS

CYLINDER HEAD AND MANIFOLD STUDS

- DIN 939 * Regular pitch.
- Mild Steel 5.8. * Plain Finsih

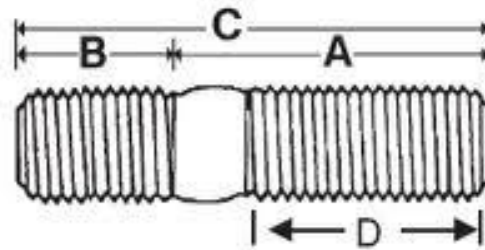

J&B #	A DIAMETER & LENTGH	B DIAMETER & LENGTH	C OVERALL LENGTH	D LENGTH	QTY
4060	6mm-1.00 x 20mm	6mm-1.00 x 7.5mm	27.5mm	18mm	10
4061	6mm-1.00 x 25mm	6mm-1.00 x 7.5mm	32.5mm	18mm	10
4062	8mm-1.25 x 20mm	8mm-1.25 x 10mm	30.0mm	16mm	10
4063	8mm-1.25 x 25mm	8mm-1.25 x 10mm	35.0mm	22mm	10
4064	8mm-1.25 x 30mm	8mm-1.25 x 10mm	40.0mm	22mm	10
4065	8mm-1.25 x 35mm	8mm-1.25 x 10mm	45.0mm	22mm	10
4066	8mm-1.25 x 40mm	8mm-1.25 x 10mm	50.0mm	22mm	10
4067	8mm-1.25 x 55mm	8mm-1.25 x 10mm	65.0mm	22mm	10
4068	10mm-1.50 x 30mm	10mm-1.50 x 9mm	42.0mm	18mm	10
4069	10mm-1.50 x 35mm	10mm-1.50 x 12mm	47.0mm	26mm	10
4070	10mm-1.50 x 40mm	10mm-1.50 x 12mm	52.0mm	26mm	10
4072	10mm-1.50 x 60mm	10mm-1.50 x 12mm	72.0mm	26mm	5
4073	12mm-1.75 x 30mm	12mm-1.75 x 15mm	45.0mm	25mm	5

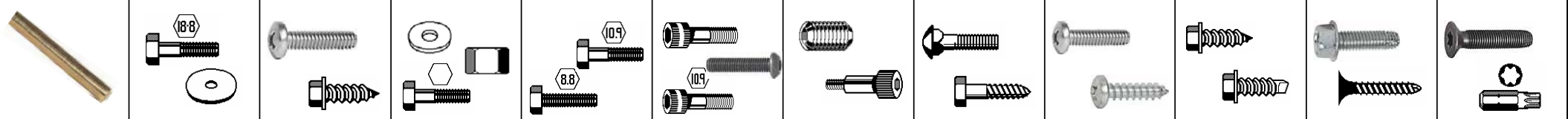

























J&B Fleet - Industrial Supply

22428 Harrisburg-Westville Rd. Alliance, Ohio 44601 Phone: (330) 821-6342 Fax: (330) 821-0411

www.jbfleet.com

PART # 2028

METRIC HEX CAP – COARSE 8.8

<p>5614 ¹</p>  <p>M12 X 1.75 PITCH HEX NUT</p> <p>20</p>	<p>5812 ²</p>  <p>M12 LOCK WASHER</p> <p>20</p>	<p>5094 ³</p>  <p>M12 -1.75 X 30</p> <p>5</p>	<p>5096 ⁴</p>  <p>M12 - 1.75 X 40</p> <p>5</p>	<p>5098 ⁵</p>  <p>M12-1.75 X 50</p> <p>5</p>	<p>5100 ⁶</p>  <p>M12 - 1.75 X 60</p> <p>3</p>
<p>5612 ⁷</p>  <p>M10 X 1.50 PITCH HEX NUT</p> <p>20</p>	<p>5810 ⁸</p>  <p>M10 LOCK WASHER</p> <p>20</p>	<p>5076 ⁹</p>  <p>M10 - 1.50 X 20</p> <p>10</p>	<p>5078 ¹⁰</p>  <p>M10 - 1.50 X 30</p> <p>10</p>	<p>5080 ¹¹</p>  <p>M10 - 1.50 X 40</p> <p>5</p>	<p>5082 ¹²</p>  <p>M10 - 1.50 X 50</p> <p>3</p>
<p>5610 ¹³</p>  <p>M8 X 1.25 PITCH HEX NUT</p> <p>25</p>	<p>5808 ¹⁴</p>  <p>M8 LOCK WASHER</p> <p>25</p>	<p>5054 ¹⁵</p>  <p>M8 - 1.25 X 20</p> <p>15</p>	<p>5056 ¹⁶</p>  <p>M8 - 1.25 X 25</p> <p>10</p>	<p>5058 ¹⁷</p>  <p>M8 - 1.25 X 30</p> <p>5</p>	<p>5062 ¹⁸</p>  <p>M8 - 1.25 X 40</p> <p>5</p>
<p>5606 ¹⁹</p>  <p>M6 X 1.00 PITCH HEX NUT</p> <p>50</p>	<p>5804 ²⁰</p>  <p>M6 LOCK WASHER</p> <p>50</p>	<p>5022 ²¹</p>  <p>M6 - 1.00 X 10</p> <p>25</p>	<p>5026 ²²</p>  <p>M6 - 1.00 X 20</p> <p>20</p>	<p>5028 ²³</p>  <p>M6 - 1.00 X 25</p> <p>15</p>	<p>5030 ²⁴</p>  <p>M6 - 1.00 X 30</p> <p>10</p>

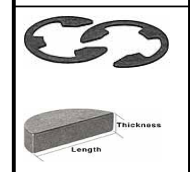
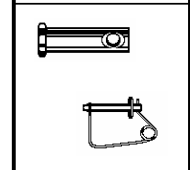
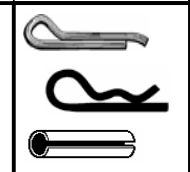
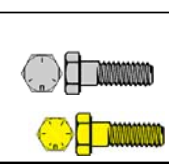
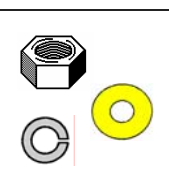
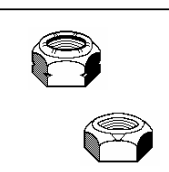
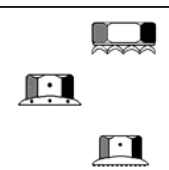
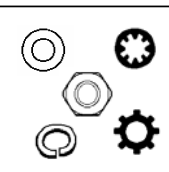

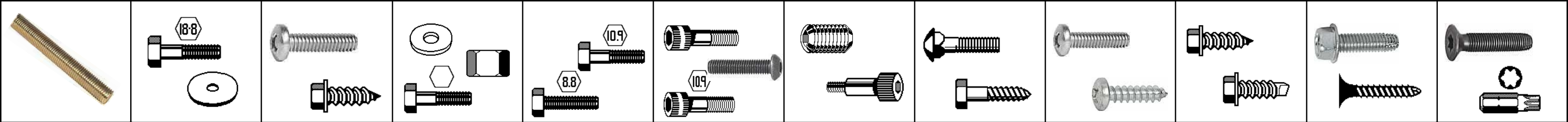

















J&B Fleet - Industrial Supply

www.jbfleet.com

22428 Harrisburg-Westville Rd. Alliance, Ohio 44601 Phone: (330) 821-6342 Fax: (330) 821-0411

PART# 2831

STAINLESS METRIC HEX HEAD CAP SCREWS

 45756 ¹ 6MM-1.00 HEX NUT 10	 45768 ² 6-1.00 X 20 10	 45769 ³ 6-1.00 X 25 10	 45770 ⁴ 6-1.00 X 30 10	 45772 ⁵ 6-1.00 X 40 10	 45774 ⁶ 6-1.00 X 50 10
 45757 ⁷ 8MM-1.25 HEX NUT 10	 45777 ⁸ 8-1.25 X 20 10	 45778 ⁹ 8-1.25 X 25 10	 45779 ¹⁰ 8-1.25 X 30 10	 45781 ¹¹ 8-1.25 X 40 10	 45783 ¹² 8-1.25 X 50 5
 45758 ¹³ 10MM-1.50 HEX NUT 10	 45786 ¹⁴ 10-1.50 X 20 10	 45787 ¹⁵ 10-1.50 X 25 10	 45788 ¹⁶ 10-1.50 X 30 5	 45790 ¹⁷ 10-1.50 X 40 5	 45792 ¹⁸ 10-1.50 X 50 5
 45760 ¹⁹ 6MM FLAT WASHERS 25	 45761 ²⁰ 8MM FLAT WASHERS 25	 45762 ²¹ 10MM FLAT WASHERS 25	 45764 ²² 6MM LOCK WASHERS 25	 45765 ²³ 8MM LOCK WASHERS 25	 45766 ²⁴ 10MM LOCK WASHERS 25

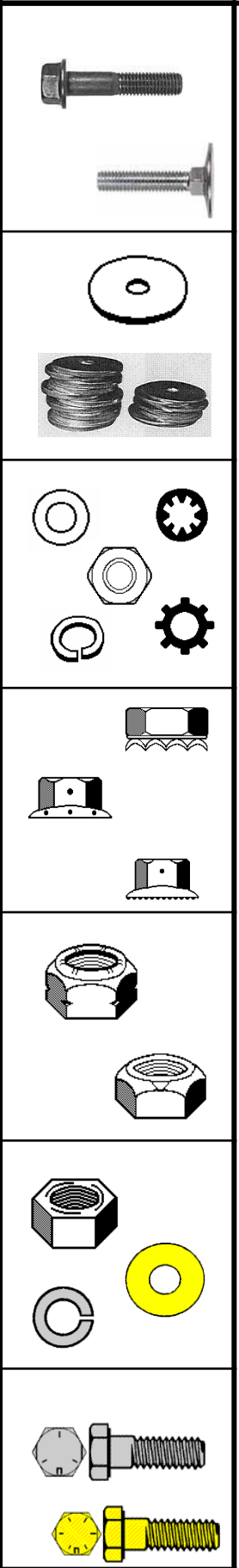

METRIC ASSORTMENTS

2180 METRIC 8.8 CAP SCREWS



5606 6-1.00 NUT 100		5610 8-1.25 NUT 50	5612 10-1.50 NUT 50	5614 12-1.75 NUT 25	5616 14-2.00 NUT 10	5618 16-2.00 NUT 10	
5824 6 MM FLAT 100		5828 8 MM FLAT 100	5830 10 MM FLAT 50	5832 12 MM FLAT 50	5834 14 MM FLAT 10	5836 16 MM FLAT 10	
5804 6 MM LOCK 100		5808 8 MM LOCK 100	5810 10 MM LOCK 50	5812 12 MM LOCK 50	5814 14 MM LOCK 10	5816 16 MM LOCK 10	
5026 6 x 20 1.00 P 25	5028 6 x 25 1.00 P 25	5030 6 x 30 1.00 P 10	5032 6 x 35 1.00 P 10	5034 8 x 40 1.00 P 10	5038 6 x 50 1.00 P 10	5040 6 x 60 1.00 P 10	
	5054 8 x 20 1.25 P 25	5056 8 x 25 1.25 P 25	5058 8 x 30 1.25 P 10	5060 8 x 35 1.25 P 10	5062 8 x 40 1.25 P 10	5066 8 x 50 1.25 P 10	5068 8 x 60 1.25 P 10
5072 8 x 75 1.25 P 5		5076 10 x 20 1.50 P 25	25039 10 x 25 1.50 P 10	5078 10 x 30 1.50 P 10	25040 10 x 35 1.50 P 10	5080 10 x 40 1.50 P 10	
5082 10 x 50 1.50 P 10	5084 10 x 60 1.50 P 10		38449 10 x 80 1.50 P 5	38450 10 x 100 1.50 P 3	5094 12 x 30 1.75 P 10		5096 12 x 40 1.75 P 10
5098 12 x 50 1.75 P 10	5100 12 x 60 1.75 P 10		38451 12 x 80 1.75 P 5	25046 12 x 100 1.75 P 3	39302 14 x 30 2.00 P 10	39304 14 x 40 2.00 P 5	39306 14 x 50 2.00 P 5
39308 14 x 60 2.00 P 5	25047 16 x 30 2.00 P 5	25084 16 x 40 2.00 P 5		5138 16 x 60 2.00 P 3	5146 16 x 80 2.00 P 3		

6MM THRU 16MM
1272 PIECES

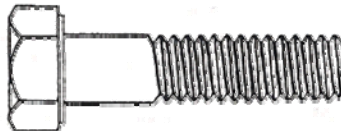

TENSILE STRENGTH:
113,000 PSI MIN. TO
142,000 PSI MAX.



METRIC ASSORTMENTS

2182 METRIC 8.8 CAP SCREWS



5606 6-1.00 NUT 100	5824 6 MM FLAT 100	5804 6 MM LOCK 100	5026 6 x 20 1.00 P 25	5028 6 x 25 1.00 P 20	5030 6 x 30 1.00 P 10	5034 6 x 40 1.00 P 10	5038 6 x 50 1.00 P 10
5610 8-1.25 NUT 50	5828 8 MM FLAT 100	5808 8 MM LOCK 100	5054 8 x 20 1.25 P 25	5056 8 x 25 1.25 P 20	5058 8 x 30 1.25 P 10	5062 8 x 40 1.25 P 10	5066 8 x 50 1.25 P 10
5612 10-1.50 NUT 50	5830 10 MM FLAT 50	5810 10 MM LOCK 50	5076 10 x 20 1.50 P 25	5078 10 x 30 1.50 P 10	5080 10 x 40 1.50 P 10	5082 10 x 50 1.50 P 10	5084 10 x 60 1.50 P 10
5614 12-1.75 NUT 25	5832 12 MM FLAT 50	5812 12 MM LOCK 50	5094 12 x 30 1.75 P 10	5096 12 x 40 1.75 P 10	5098 12 x 50 1.75 P 10	5100 12 x 60 1.75 P 10	
5616 14-2.00 NUT 10	5834 14 MM FLAT 10	5814 14 MM LOCK 10	39302 14 x 30 2.00 P 10	39304 14 x 40 2.00 P 5	39306 14 x 50 2.00 P 5	39308 14 x 60 2.00 P 5	

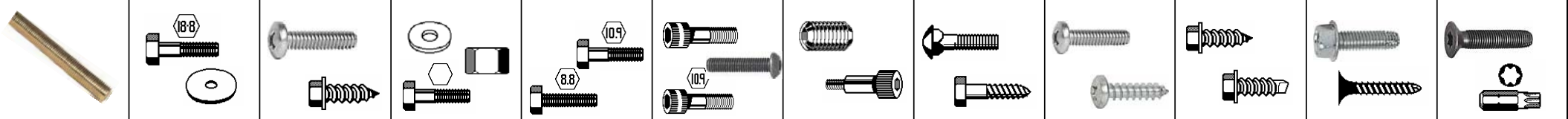

























J&B Fleet - Industrial Supply

22428 Harrisburg-Westville Rd. Alliance, Ohio 44601 Phone: (330) 821-6342 Fax: (330) 821-0411

www.jbfleet.com

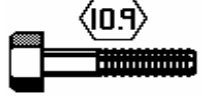
PART # 2216

10.9 METRIC HEX CAP / COARSE

 53112 ¹ M12 - 1.75 <small>20</small>	 53132 ² M12 WASHER <small>20</small>	 53265 ³ M12 - 1.75 X 30 <small>5</small>	 53267 ⁴ M12 - 1.75 X 40 <small>5</small>	 53269 ⁵ M12 - 1.75 X 50 <small>5</small>	 53271 ⁶ M12 - 1.75 X 60 <small>3</small>
 53111 ⁷ M10 - 1.50 <small>20</small>	 53131 ⁸ M10 WASHER <small>20</small>	 53243 ⁹ M10 - 1.50 X 25 <small>10</small>	 53244 ¹⁰ M10 - 1.50 X 30 <small>10</small>	 53246 ¹¹ M10 - 1.50 X 40 <small>5</small>	 53248 ¹² M10 - 1.50 X 50 <small>5</small>
 53110 ¹³ M8 - 1.25 <small>20</small>	 53130 ¹⁴ M8 WASHER <small>20</small>	 53223 ¹⁵ M8 -1.25 X 20 <small>10</small>	 53224 ¹⁶ M8 -1.25 X 25 <small>10</small>	 53225 ¹⁷ M8 -1.25 X 30 <small>10</small>	 53227 ¹⁸ M8 -1.25 X 40 <small>10</small>
 53108 ¹⁹ M6 - 1.00 <small>20</small>	 53128 ²⁰ M6 WASHER <small>20</small>	 53207 ²¹ M6 -1.00 X 20 <small>10</small>	 53208 ²² M6 -1.00 X 25 <small>10</small>	 53209 ²³ M6 -1.00 X 30 <small>10</small>	 53211 ²⁴ M6 -1.00 X 40 <small>10</small>

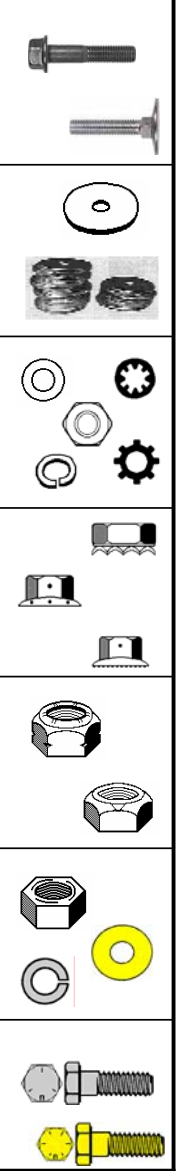















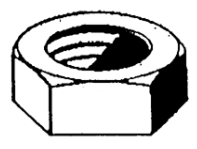

J&B Fleet - Industrial Supply

22428 Harrisburg-Westville Rd. Alliance, Ohio 44601 Phone: (330) 821-6342 Fax: (330) 821-0411

www.jbfleet.com

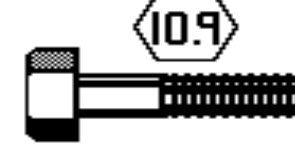
PART # 2880

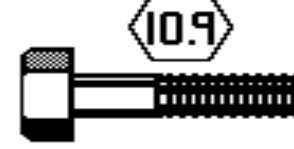
HEX HEAD CAP SCREW ISO 4017 10.9

<p>36414 1</p>  <p>12-1.75 X 40</p> <p>5</p>	<p>36415 2</p>  <p>12-1.75 X 45</p> <p>5</p>	<p>36416 3</p>  <p>12-1.75 X 50</p> <p>5</p>	<p>36421 4</p>  <p>12-1.75 HEX NUT</p> <p>20</p>
<p>36410 5</p>  <p>12-1.75 X 20</p> <p>10</p>	<p>36411 6</p>  <p>12-1.75 X 25</p> <p>10</p>	<p>36412 7</p>  <p>12-1.75 X 30</p> <p>10</p>	<p>36413 8</p>  <p>12-1.75 X 35</p> <p>5</p>
<p>36404 9</p>  <p>10-1.50 X 40</p> <p>5</p>	<p>36405 10</p>  <p>10-1.50 X 45</p> <p>5</p>	<p>36406 11</p>  <p>10-1.50 X 50</p> <p>5</p>	<p>36420 12</p>  <p>10-1.50 HEX NUT</p> <p>20</p>
<p>36400 13</p>  <p>10-1.50 X 20</p> <p>10</p>	<p>36401 14</p>  <p>10-1.50 X 25</p> <p>10</p>	<p>36402 15</p>  <p>10-1.50 X 30</p> <p>10</p>	<p>36403 16</p>  <p>10-1.50 X 35</p> <p>5</p>



PART# 2241

**HEX HEAD CAP
SCREW**

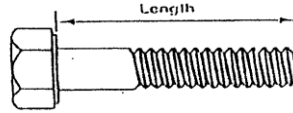

1135 PIECES

53108 6-1.00 Nut 100	53128 6MM Flat Washers 100	5804 6 MM Lock Washers 100	53207 6 x 20 1.00 Pitch 25	53208 6 x 25 1.00 Pitch 20	53209 6 x 30 1.00 Pitch 10	53211 6 x 40 1.00 Pitch 10	53213 6 x 50 1.00 Pitch 10
53110 8-1.25 Nut 50	53130 8MM Flat Washers 100	5808 8MM Lock Washers 100	53223 8 x 20 1.25 Pitch 25	53224 8 x 25 1.25 Pitch 20	53225 8 x 30 1.25 Pitch 10	53227 8 x 40 1.25 Pitch 10	53229 8 x 50 1.25 Pitch 10
53111 10-1.50 Nut 50	53131 10MM Flat Washers 50	5810 10MM Lock Washers 50	53242 10 x 20 1.50 Pitch 25	53244 10 x 30 1.50 Pitch 10	53246 10 x 40 1.50 Pitch 10	53248 10 x 50 1.50 Pitch 10	53250 10 x 60 1.50 Pitch 10
53112 12-1.75 Nut 25	53132 12MM Flat Washers 50	5812 12MM Lock Washers 50	53265 12 x 30 1.75 Pitch 10	53267 12 x 40 1.75 Pitch 10	53269 12 x 50 1.75 Pitch 10	53271 12 x 60 1.75 Pitch 10	
53113 14-2.00 Nut 10	53133 14 MM Flat Washers 10	5814 14MM Lock Washers 10	53282 14 x 30 2.00 Pitch 10	53286 14 x 40 2.00 Pitch 5	53288 14 x 50 2.00 Pitch 5	53290 14 x 60 2.00 Pitch 5	

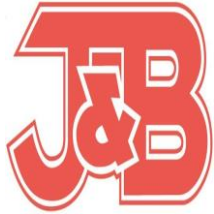
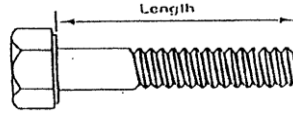
PART# 2242**HEX HEAD CAP
SCREW****1233 PIECES**

53108 6-1.00 Nuts 100	53110 8-1.25 Nuts 50	53111 10-1.50 Nuts 50	53112 12-1.75 Nuts 25	53113 14-2.00 Nuts 10	53114 16-2.00 Nuts 10		
53128 6MM Flat Washer 100	53130 8MM Flat Washer 100	53131 10MM Flat Washer 50	53132 12MM Flat Washer 50	53133 14MM Flat Washer 10	53134 16MM Flat Washer 10		
5804 6MM Lock Washer 100	5808 8MM Lock Washer 100	5810 10MM Lock Washer 50	5812 12MM Lock Washer 50	5814 14MM Lock Washer 10	5816 16MM Lock Washer 10		
53207 6 x 20 1.00 Pitch 20	53208 6 x 25 1.00 Pitch 20	53209 6 x 30 1.00 Pitch 20	53210 6 x 35 1.00 Pitch 10	53211 6 x 40 1.00 Pitch 10	53213 6 x 50 1.00 Pitch 10		53223 8 x 20 1.25 Pitch 20
53224 8 x 25 1.25 Pitch 10	53225 8 x 30 1.25 Pitch 10	53226 8 x 35 1.25 Pitch 10	53227 8 x 40 1.25 Pitch 10	53229 8 x 50 1.25 Pitch 10	53230 8 x 60 1.25 Pitch 10	53231 8 x 70 1.25 Pitch 5	
53242 10 X 20 1.50 Pitch 10	53243 10 X 25 1.50 Pitch 10	53244 10 X 30 1.50 Pitch 10	53245 10 X 35 1.50 Pitch 10	53246 10 X 40 1.50 Pitch 10	53248 10 X 50 1.50 Pitch 10	53250 10 X 60 1.50 Pitch 10	53252 10 X 70 1.50 Pitch 5
53254 10 X 80 1.50 Pitch 5		53256 10 X 100 1.50 Pitch 5	53265 12 x 30 1.75 Pitch 10	53267 12 x 40 1.75 Pitch 10	53269 12 x 50 1.75 Pitch 10	53271 12 x 60 1.75 Pitch 5	53273 12 x 70 1.75 Pitch 5
53274 12 x 80 1.75 Pitch 3		53276 12 x 100 1.75 Pitch 3	53282 14 x 30 2.00 Pitch 5	53286 14 x 40 2.00 Pitch 5	53288 14 x 50 2.00 Pitch 5	53290 14 x 60 2.00 Pitch 5	
53295 14 x 100 2.00 Pitch 3	53308 16 x 40 2.00 Pitch 5	53309 16 x 50 2.00 Pitch 5	53310 16 x 60 2.00 Pitch 3		53313 16 x 80 2.00 Pitch 3	53315 16 x 100 2.00 Pitch 3	

2242 – Assortment with one 72-hole bin**2242P** - Assortment with two 40-hole ZZNS40 bins**2242D** - Assortment with two 40-hole 38176 bins

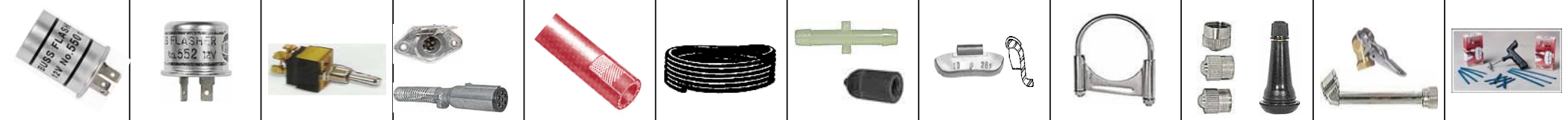













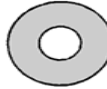





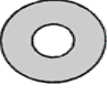





J&B Fleet - Industrial Supply

22428 Harrisburg-Westville Rd. Alliance, Ohio 44601 Phone: (330) 821-6342 Fax: (330) 821-0411

www.jbfleet.com

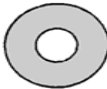
PART # 2050

METRIC HEX CAP SCREW – FINE 8.8

<p>5701 ¹</p>  <p>HEX NUT M8 X 1.00 PITCH</p> <p>50</p>	<p>5808 ²</p>  <p>M8 LOCKWASHER</p> <p>50</p>	<p>5828 ³</p>  <p>M8 FLATWASHER</p> <p>50</p>	<p>5203 ⁴</p>  <p>M8 X 1.00 X 20</p> <p>25</p>	<p>5207 ⁵</p>  <p>M8 X 1.00 X 30</p> <p>20</p>	<p>5211 ⁶</p>  <p>M8 X 1.00 X 40</p> <p>15</p>
<p>5703 ⁷</p>  <p>HEX NUT M10 X 1.00 PITCH</p> <p>35</p>	<p>5810 ⁸</p>  <p>M10 LOCKWASHER</p> <p>35</p>	<p>5830 ⁹</p>  <p>M10 FLATWASHER</p> <p>35</p>	<p>5215 ¹⁰</p>  <p>M10 X 1.00 X 20</p> <p>20</p>	<p>5219 ¹¹</p>  <p>M10 X 1.00 X 30</p> <p>15</p>	<p>5213 ¹²</p>  <p>M8 X 1.00 X 50</p> <p>10</p>
<p>5705 ¹³</p>  <p>HEX NUT M10 X 1.25 PITCH</p> <p>35</p>	<p>5227 ¹⁴</p>  <p>M10 X 1.25 X 25</p> <p>10</p>	<p>5229 ¹⁵</p>  <p>M10 X 1.25 X 30</p> <p>10</p>	<p>5233 ¹⁶</p>  <p>M10 X 1.25 X 40</p> <p>5</p>	<p>5235 ¹⁷</p>  <p>M10 X 1.25 X 50</p> <p>5</p>	<p>5223 ¹⁸</p>  <p>M10 X 1.00 X 50</p> <p>5</p>
<p>5709 ¹⁹</p>  <p>HEX NUT M12 X 1.50 PITCH</p> <p>20</p>	<p>5812 ²⁰</p>  <p>M12 LOCKWASHER</p> <p>20</p>	<p>5832 ²¹</p>  <p>M12 FLATWASHER</p> <p>20</p>	<p>5251 ²²</p>  <p>M12 X 1.50 X 40</p> <p>5</p>	<p>5253 ²³</p>  <p>M12 X 1.50 X 50</p> <p>5</p>	<p>5255 ²⁴</p>  <p>M12 X 1.50 X 60</p> <p>5</p>



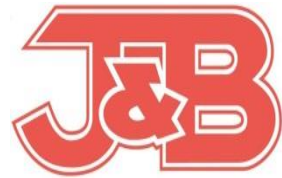













PART #2257

J&B Fleet - Industrial Supply

22428 Harrisburg-Westville Rd. Alliance, Ohio 44601 Phone: (330) 821-6342 Fax: (330) 821-0411

www.jbfleet.com

JIS HEX HEAD CAP SCREWS

 4214 12 -1.25 X 20	 4219 12 -1.25 X 40	 4227 12 -1.25 X 80
 4215 12 -1.25 X 25	 4221 12 -1.25 X 50	 4229 12 -1.25 X 90
 4216 12 -1.25 X 30	 4223 12 -1.25 X 60	 4231 12 -1.25 X 100
 4217 12 -1.25 X 35	 4225 12 -1.25 X 70	 4210 12 -1.25 X WAF 17MM NUT



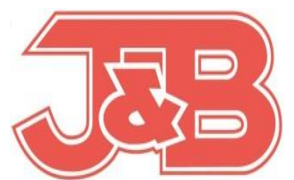























PART # 2210

J&B Fleet - Industrial Supply

22428 Harrisburg-Westville Rd. Alliance, Ohio 44601 Phone: (330) 821-6342 Fax: (330) 821-0411

www.jbfleet.com

10.9 JIS METRIC FLANGE BOLTS

<p>42446 1</p>  <p>M6 - 1.00</p> <p>20</p>	<p>42399 2</p>  <p>M6 - 1.00 X 10</p> <p>10</p>	<p>42400 3</p>  <p>M6 - 1.00 X 12</p> <p>10</p>	<p>42401 4</p>  <p>M6 - 1.00 X 16</p> <p>10</p>	<p>42402 5</p>  <p>M6 - 1.00 X 20</p> <p>10</p>	<p>42403 6</p>  <p>M6 - 1.00 X 25</p> <p>10</p>
<p>42404 7</p>  <p>M6 - 1.00 X 30</p> <p>10</p>	<p>42405 8</p>  <p>M6 - 1.00 X 35</p> <p>10</p>	<p>42406 9</p>  <p>M6 - 1.00 X 40</p> <p>10</p>	<p>42407 10</p>  <p>M6 - 1.00 X 45</p> <p>10</p>	<p>42408 11</p>  <p>M6 - 1.00 X 50</p> <p>10</p>	<p>42412 14</p>  <p>M8 - 1.25 X 12</p> <p>10</p>
<p>42447 13</p>  <p>M8 - 1.25</p> <p>20</p>	<p>42413 15</p>  <p>M8 - 1.25 X 16</p> <p>10</p>	<p>42414 16</p>  <p>M8 - 1.25 X 20</p> <p>10</p>	<p>42415 17</p>  <p>M8 - 1.25 X 25</p> <p>10</p>	<p>42416 18</p>  <p>M8 - 1.25 X 30</p> <p>10</p>	
<p>42417 19</p>  <p>M8 - 1.25 X 35</p> <p>10</p>	<p>42418 20</p>  <p>M8 - 1.25 X 40</p> <p>10</p>	<p>42419 21</p>  <p>M8 - 1.25 X 45</p> <p>10</p>	<p>42420 22</p>  <p>M8 - 1.25 X 50</p> <p>10</p>	<p>42422 23</p>  <p>M8 - 1.25 X 60</p> <p>10</p>	<p>42409 12</p>  <p>M6 - 1.00 X 25</p> <p>10</p>



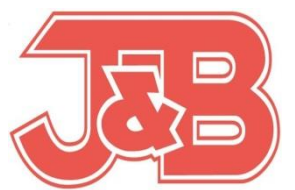
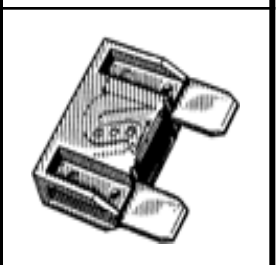
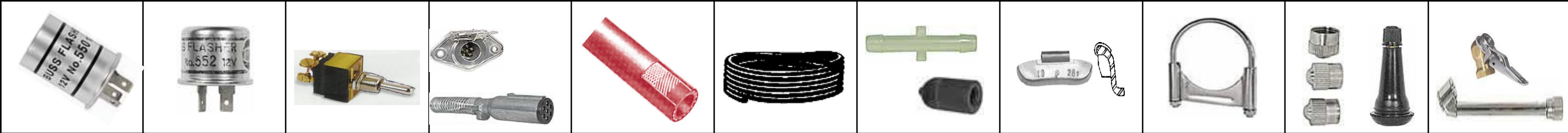















PART # 2214

J&B Fleet - Industrial Supply

22428 Harrisburg-Westville Rd. Alliance, Ohio 44601 Phone: (330) 821-6342 Fax: (330) 821-0411

www.jbfleet.com

10.9 JIS METRIC FLANGE BOLTS

<p>20</p> <p>42448</p>  <p>M10 - 1.25</p>	<p>10</p> <p>42430</p>  <p>M10 - 1.25 X 16</p>	<p>10</p> <p>42431</p>  <p>M10 - 1.25 X 20</p>	<p>10</p> <p>42432</p>  <p>M10 - 1.25 X 25</p>
<p>10</p> <p>42433</p>  <p>M10 - 1.25 X 30</p>	<p>10</p> <p>42434</p>  <p>M10 - 1.25 X 35</p>	<p>10</p> <p>42435</p>  <p>M10 - 1.25 X 40</p>	<p>10</p> <p>42436</p>  <p>M10 - 1.25 X 45</p>
<p>10</p> <p>42437</p>  <p>M10 - 1.25 X 50</p>	<p>10</p> <p>42439</p>  <p>M10 - 1.25 X 60</p>	<p>10</p> <p>42441</p>  <p>M10 - 1.25 X 70</p>	<p>5</p> <p>45501</p>  <p>M10 - 1.25 X 80</p>
<p>5</p> <p>45502</p>  <p>M10 - 1.25 X 90</p>	<p>5</p> <p>45503</p>  <p>M10 - 1.25 X 100</p>		















J&B Fleet - Industrial Supply

www.jbfleet.com

22428 Harrisburg-Westville Rd. Alliance, Ohio 44601 Phone: (330) 821-6342 Fax: (330) 821-0411

PART # 2215

10.9 FLANGE BOLTS

 38851 M10 – 1.50 20	 38852 M10 – 1.50 X 20 10	 38853 M10 – 1.50 X 25 10
 38854 M10 – 1.50 X 30 10	 38856 M10 – 1.50 X 35 10	 38857 M10 – 1.50 X 40 10
 38858 M10 – 1.50 X 45 10	 38859 M10 – 1.50 X 50 10	 38861 M10 – 1.50 X 60 5
 38863 M10 – 1.50 X 80 5		













J&B Fleet - Industrial Supply

www.jbfleet.com

22428 Harrisburg-Westville Rd. Alliance, Ohio 44601 Phone: (330) 821-6342 Fax: (330) 821-0411

PART# 2830

10.9 METRIC FLANGE BOLTS

 10014 1 M12 - 1.75 20	 38867 2 M12 - 1.75 X 25 10	 38868 3 M12 - 1.75 X 30 10
 38869 4 M12 - 1.75 X 35 10	 38870 5 M12 - 1.75 X 40 10	 38871 6 M12 - 1.75 X 50 10
 38872 7 M12 - 1.75 X 60 10	 38877 8 M12 - 1.75 X 80 10	9 12
10	11	12



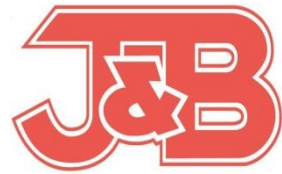









J&B Fleet - Industrial Supply

www.jbfleet.com

22428 Harrisburg-Westville Rd. Alliance, Ohio 44601 Phone: (330) 821-6342 Fax: (330) 821-0411

PART # 2842

10.9 JIS METRIC FLANGE BOLTS

 45514 M12 - 1.25 20	 45504 M12 - 1.25 X 20 10	 45505 M12 - 1.25 X 25 10
 45506 M12 - 1.25 X 30 10	 45507 M12 - 1.25 X 35 10	 45508 M12 - 1.25 X 40 10
 45509 M12 - 1.25 X 45 10	 45510 M12 - 1.25 X 50 10	 45511 M12-1.25 X 55 5
<p>10</p>	<p>11</p>	<p>12</p>

























J&B Fleet - Industrial Supply

22428 Harrisburg-Westville Rd. Alliance, Ohio 44601 Phone: (330) 821-6342 Fax: (330) 821-0411

www.jbfleet.com

PART # 2184

METRIC SOCKET HEAD CAP SCREWS

<p>25055 ¹</p>  <p>4 x 10MM x .70 P</p> <p>25</p>	<p>25056 ²</p>  <p>4 x 20MM x .70 P</p> <p>20</p>	<p>25057 ³</p>  <p>4 x 30MM x .70 P</p> <p>10</p>	<p>25058 ⁴</p>  <p>5 x 10MM x .80 P</p> <p>25</p>	<p>25059 ⁵</p>  <p>5 x 20MM x .80 P</p> <p>20</p>	<p>25060 ⁶</p>  <p>5 x 30MM x .80 P</p> <p>10</p>
<p>25061 ⁷</p>  <p>6 x 10MM x 1.00P</p> <p>25</p>	<p>25062 ⁸</p>  <p>6 x 20MM x 1.00P</p> <p>20</p>	<p>38391 ⁹</p>  <p>6 x 25MM x 1.00P</p> <p>10</p>	<p>25063 ¹⁰</p>  <p>6 x 30MM x 1.00P</p> <p>10</p>	<p>¹¹</p>	<p>25066 ¹²</p>  <p>6 x 50MM x 1.00P</p> <p>5</p>
<p>¹³</p>	<p>25072 ¹⁴</p>  <p>8 x 20MM x 1.25P</p> <p>10</p>	<p>38392 ¹⁵</p>  <p>8 x 25MM x 1.25P</p> <p>10</p>	<p>25073 ¹⁶</p>  <p>8 x 30MM x 1.25P</p> <p>10</p>	<p>25074 ¹⁷</p>  <p>8 x 40MM x 1.25P</p> <p>5</p>	<p>25075 ¹⁸</p>  <p>8 x 50MM x 1.25P</p> <p>5</p>
<p>¹⁹</p>	<p>25088 ²⁰</p>  <p>10 x 20MM x 1.50P</p> <p>10</p>	<p>25077 ²¹</p>  <p>10 x 30MM x 1.50P</p> <p>5</p>	<p>25078 ²²</p>  <p>10 x 40MM x 1.50P</p> <p>5</p>	<p>25079 ²³</p>  <p>10 x 50MM x 1.50P</p> <p>3</p>	<p>²⁴</p>



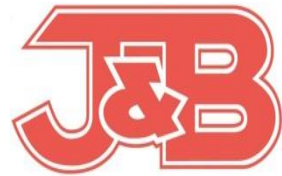







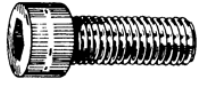
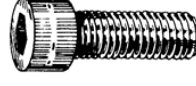
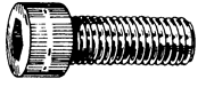
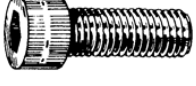
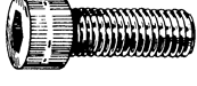

J&B Fleet - Industrial Supply

www.jbfleet.com

22428 Harrisburg-Westville Rd. Alliance, Ohio 44601 Phone: (330) 821-6342 Fax: (330) 821-0411

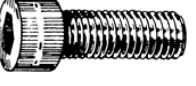
PART # 2286

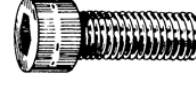
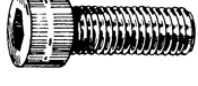
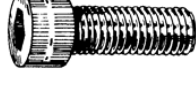
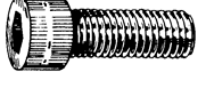
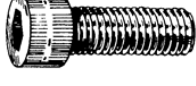
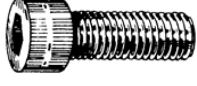
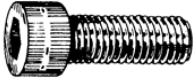
METRIC STAINLESS SOCKET CAPS

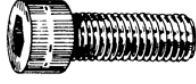
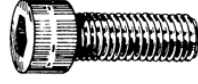
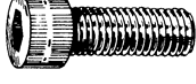
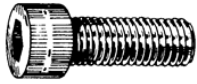
 4237 ¹ 5-.80 X 10 10	 4239 ² 5-.80 X 16 10	 4240 ³ 5-.80 X 20 10	 4241 ⁴ 5-.80 X 25 10	 4242 ⁵ 5-.80 X 30 10	 4244 ⁶ 5-.80 X 40 10
 4246 ⁷ 5-.80 X 50 10	 4150 ⁸ 6-1.00 X 10 10	 4151 ⁹ 6-1.00 X 16 10	 4152 ¹⁰ 6-1.00 X 20 10	 4153 ¹¹ 6-1.00 X 25 10	 4154 ¹² 6-1.00 X 30 10
 4156 ¹³ 6-1.00 X 40 10	 4157 ¹⁴ 6-1.00 X 50 10	 4160 ¹⁵ 8-1.25 X 20 10	 4161 ¹⁶ 8-1.25 X 25 10	 4162 ¹⁷ 8-1.25 X 30 10	 4164 ¹⁸ 8-1.25 X 40 5
 4166 ¹⁹ 8-1.25 X 50 5	 4170 ²⁰ 10-1.50 X 20 5	 4171 ²¹ 10-1.50 X 25 5	 4172 ²² 10-1.50 X 30 5	 4174 ²³ 10-1.50 X 40 5	 4176 ²⁴ 10-1.50 X 50 5

















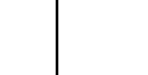

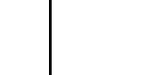









J&B Fleet - Industrial Supply

22428 Harrisburg-Westville Rd. Alliance, Ohio 44601 Phone: (330) 821-6342 Fax: (330) 821-0411

www.jbfleet.com

PART # 2223

METRIC SET SCREWS

 87010 ¹ 3MM- .50 X 6 20	 87011 ² 3MM - .50 X 8 20	 87012 ³ 4MM - .70 X 6 20	 36936 ⁴ 4MM X .70 X 8 20	 87013 ⁵ 4MM - .70 X 10 20	 7	 8	
 36940 ⁹ 5MM - .80 X 8 20	 36941 ¹⁰ 5MM - .80 X 10 20	 87014 ¹¹ 5MM - .80 X 12 20	 36943 ¹² 5MM - .80 X 16 20	 36946 ¹³ 6MM -1.00 X 8 15	 36947 ¹⁴ 6MM -1.00 X 10 15	 87015 ¹⁵ 6MM -1.00 X 12 15	
 36949 ¹⁷ 6MM -1.00 X 16 15	 87016 ¹⁸ 8MM -1.25 X 8 10	 36952 ¹⁹ 8MM -1.25 X 10 10	 36954 ²⁰ 8MM -1.25 X 16 10	 36955 ²¹ 8MM -1.25 X 20 10	 36956 ²² 8MM -1.25 X 25 5	 24	
 87017 ²⁵ 10MM -1.50 X 12 5	 36960 ²⁶ 10MM -1.50 X 16 5	 36961 ²⁷ 10MM -1.50 X 20 5	 36963 ²⁸ 10MM -1.50 X 30 5	29	30	31	32



LET US HELP YOU MAKE THE CONNECTION

PART # 3027



METRIC SET SCREWS



J & B FLEET-INDUSTRIAL SUPPLY
PHONE: 330-821-6342

87010 3MM - .50 X 6 10	87011 3MM - .50 X 8 10	87012 4MM - .70 X 6 10	36936 4MM - .70 X 8 10	87013 4MM - .70 X 10 10	36940 5MM - .80 X 8 10
36941 5MM - .80 X 10 10	87014 5MM - .80 X 12 10	36943 5MM - .80 X 16 10	36946 6MM - 1.00 X 8 5	36947 6MM - 1.00 X 10 5	87015 6MM - 1.00 X 12 5
36949 6MM - 1.00 X 16 5	87016 8MM - 1.25 X 8 5	36952 8MM - 1.25 X 10 5	36954 8MM - 1.25 X 16 5	87017 10MM - 1.50 X 12 5	36960 10MM - 1.50 X 16 5















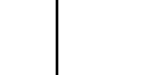











J&B Fleet - Industrial Supply

22428 Harrisburg-Westville Rd. Alliance, Ohio 44601 Phone: (330) 821-6342 Fax: (330) 821-0411

www.jbfleet.com

PART # 2223

METRIC SET SCREWS

 87010 ¹ 3MM- .50 X 6 20	 87011 ² 3MM - .50 X 8 20	 87012 ³ 4MM - .70 X 6 20	 36936 ⁴ 4MM X .70 X 8 20	 87013 ⁵ 4MM - .70 X 10 20	 7	 8
 36940 ⁹ 5MM - .80 X 8 20	 36941 ¹⁰ 5MM - .80 X 10 20	 87014 ¹¹ 5MM - .80 X 12 20	 36943 ¹² 5MM - .80 X 16 20	 36946 ¹³ 6MM -1.00 X 8 15	 36947 ¹⁴ 6MM -1.00 X 10 15	 87015 ¹⁵ 6MM -1.00 X 12 15
 36949 ¹⁷ 6MM -1.00 X 16 15	 18	 87016 ¹⁹ 8MM -1.25 X 8 10	 36952 ²⁰ 8MM -1.25 X 10 10	 36954 ²¹ 8MM -1.25 X 16 10	 36955 ²² 8MM -1.25 X 20 10	 36956 ²³ 8MM -1.25 X 25 5
 87017 ²⁵ 10MM -1.50 X 12 5	 36960 ²⁶ 10MM -1.50 X 16 5	 36961 ²⁷ 10MM -1.50 X 20 5	 36963 ²⁸ 10MM -1.50 X 30 5	29	30	31
32						

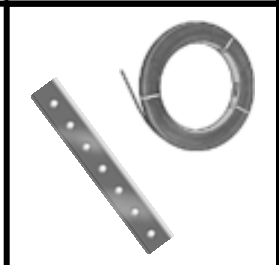

LET US HELP YOU MAKE THE CONNECTION

PART # 3027



METRIC SET SCREWS



J & B FLEET-INDUSTRIAL SUPPLY
PHONE: 330-821-6342

87010 3MM - .50 X 6 10	87011 3MM - .50 X 8 10	87012 4MM - .70 X 6 10	36936 4MM - .70 X 8 10	87013 4MM - .70 X 10 10	36940 5MM - .80 X 8 10
36941 5MM - .80 X 10 10	87014 5MM - .80 X 12 10	36943 5MM - .80 X 16 10	36946 6MM- 1.00 X 8 5	36947 6MM - 1.00 X 10 5	87015 6MM - 1.00 X 12 5
36949 6MM - 1.00 X 16 5	87016 8MM - 1.25 X 8 5	36952 8MM - 1.25 X 10 5	36954 8MM - 1.25 X 16 5	87017 10MM - 1.50 X 12 5	36960 10MM - 1.50 X 16 5



































J&B Fleet - Industrial Supply

22428 Harrisburg-Westville Rd. Alliance, Ohio 44601 Phone: (330) 821-6342 Fax: (330) 821-0411

www.jbfleet.com

PART # 2230

METRIC PHILLIPS PAN HEAD MACHINE SCREWS

 36900 ¹ M3 - .50 X 6 25	 36902 ² M3 - .50 X 10 25	 36903 ³ M3 - .50 X 12 25	 36904 ⁴ M3 - .50 X 16 25	 36908 ⁵ M4 - .70 X 6 25	 36909 ⁶ M4 - .70 X 8 25	 36910 ⁷ M4 - .70 X 10 25	 36911 ⁸ M4 - .70 X 12 25
 36912 ⁹ M4 - .70 X 16 10	 36913 ¹⁰ M4 - .70 X 20 10	 36916 ¹¹ M5 - .80 X 10 10	 36918 ¹² M5 - .80 X 16 10	 36919 ¹³ M5 - .80 X 20 10	 36920 ¹⁴ M5 - .80 X 25 10	 36924 ¹⁵ M6 -1.00 X 10 10	 36925 ¹⁶ M6 -1.00 X 12 10
 36926 ¹⁷ M6 -1.00 X 16 10	 11120 ¹⁸ M6 -1.00 X 20 10	 36928 ¹⁹ M6 -1.00 X 25 10	 36929 ²⁰ M6 -1.00 X 30 10	 5600 ²¹ M3 X .50 HEX NUT 50	 5602 ²² M4 X .70 HEX NUT 50	 5604 ²³ M5 X .80 HEX NUT 50	 5606 ²⁴ M6 X 1.00 HEX NUT 50
 41869 ²⁵ 3M HELICAL SPRING LOCK WASHER 100	 5800 ²⁶ 4M HELICAL SPRING LOCK WASHER 100	 5802 ²⁷ 5M HELICAL SPRING LOCK WASHER 100	 5804 ²⁸ 6M HELICAL SPRING LOCK WASHER 50	 41867 ²⁹ 3M FLAT WASHERS 100	 5820 ³⁰ 4M FLAT WASHERS 100	 5822 ³¹ 5M FLAT WASHERS 100	 5824 ³² 6M FLAT WASHERS 50



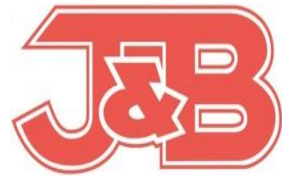











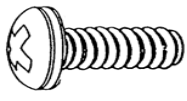
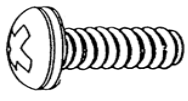
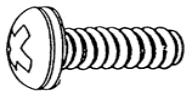
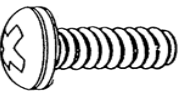
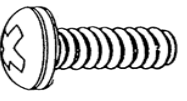
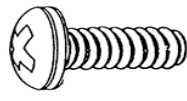
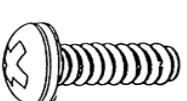
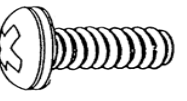
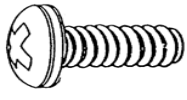
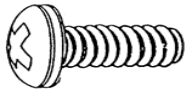
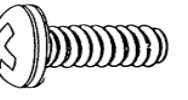
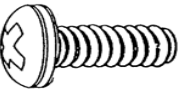
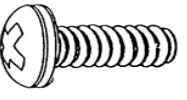
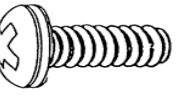
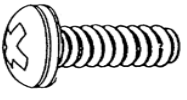
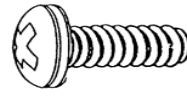
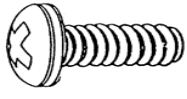
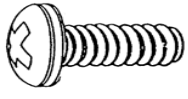
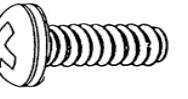
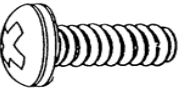

PART # 2296

J&B Fleet - Industrial Supply

22428 Harrisburg-Westville Rd. Alliance, Ohio 44601 Phone: (330) 821-6342 Fax: (330) 821-0411

www.jbfleet.com

METRIC STAINLESS MACHINE SCREWS

 57140 ¹ M3 - .50 X 6 25	 57142 ² M3 - .50 X 10 25	 57143 ³ M3 - .50 X 12 25	 57144 ⁴ M3 - .50 X 16 25	 57150 ⁵ M4 - .70 X 6 25	 57151 ⁶ M4 - .70 X 8 25	 57152 ⁷ M4 - .70 X 10 25	 57153 ⁸ M4 - .70 X 12 25
 57154 ⁹ M4 - .70 X 16 10	 57155 ¹⁰ M4 - .70 X 20 10	 57161 ¹¹ M5 - .80 X 10 10	 57163 ¹² M5 - .80 X 16 10	 57164 ¹³ M5 - .80 X 20 10	 57165 ¹⁴ M5 - .80 X 25 10	 57171 ¹⁵ M6 -1.00 X 10 10	 57172 ¹⁶ M6 -1.00 X 12 10
 57173 ¹⁷ M6 -1.00 X 16 10	 57174 ¹⁸ M6 -1.00 X 20 10	 57175 ¹⁹ M6 -1.00 X 25 10	 57176 ²⁰ M6 -1.00 X 30 10	 45715 ²¹ M3 X .50 HEX NUT 50	 45724 ²² M4 X .70 HEX NUT 50	 45751 ²³ M5 X .80 HEX NUT 50	 45756 ²⁴ M6 X 1.00 HEX NUT 50
 45717 ²⁵ 3M HELICAL SPRING LOCK WASHER 100	 45726 ²⁶ 4M HELICAL SPRING LOCK WASHER 100	 45745 ²⁷ 5M HELICAL SPRING LOCK WASHER 100	 45764 ²⁸ 6M HELICAL SPRING LOCK WASHER 50	 45716 ²⁹ 3M FLAT WASHERS 100	 45725 ³⁰ 4M FLAT WASHERS 100	 45747 ³¹ 5M FLAT WASHERS 100	 45760 ³² 6M FLAT WASHERS 50

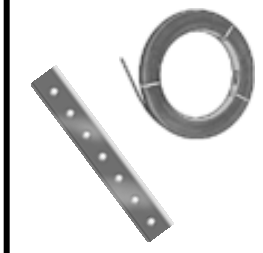

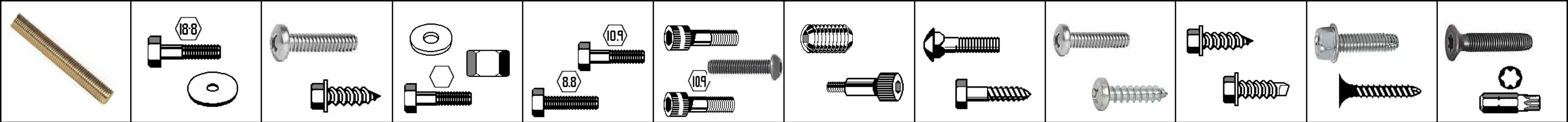

J&B Fleet - Industrial Supply

22428 Harrisburg-Westville Rd. Alliance, Ohio 44601 Phone: (330) 821-6342 Fax: (330) 821-0411

www.jbfleet.com

PART# 2278

METRIC STUDS

<p>4060 1</p> <p>A) 6MM-1.00 x 20MM B) 7.5MM C) 27.5MM D) 18MM</p> <p>5</p>	<p>4061 2</p> <p>A) 6MM-1.00 x 25MM B) 7.5MM C) 32.5MM D) 18MM</p> <p>5</p>	<p>3</p>	<p>4</p>	<p>5</p>	<p>6</p>
<p>4062 7</p> <p>A) 8MM-1.25 x 20MM B) 10MM C) 30.0MM D) 16MM</p> <p>5</p>	<p>4063 8</p> <p>A) 8MM-1.25 x 25MM B) 10MM C) 35.0MM D) 22MM</p> <p>5</p>	<p>4064 9</p> <p>A) 8MM-1.25 x 30MM B) 10MM C) 40.0MM D) 22MM</p> <p>5</p>	<p>4065 10</p> <p>A) 8MM-1.25 x 35MM B) 10MM C) 45.0MM D) 22MM</p> <p>5</p>	<p>4066 11</p> <p>A) 8MM-1.25 x 40MM B) 10MM C) 50.0MM D) 22MM</p> <p>5</p>	<p>4067 12</p> <p>A) 8MM-1.25 x 55MM B) 10MM C) 65.0MM D) 22MM</p> <p>2</p>
<p>4068 13</p> <p>A) 10MM-1.50 x 30MM B) 9MM C) 42.0MM D) 18MM</p> <p>5</p>	<p>4069 14</p> <p>A) 10MM-1.50 x 35MM B) 12MM C) 47.0MM D) 26MM</p> <p>5</p>	<p>4070 15</p> <p>A) 10MM-1.50 x 40MM B) 12MM C) 52.0MM D) 26MM</p> <p>5</p>	<p>4071 16</p> <p>A) 10MM-1.50 x 50MM B) 12MM C) 62.0MM D) 26MM</p> <p>5</p>	<p>4072 17</p> <p>A) 10MM-1.50 x 60MM B) 12MM C) 72.0MM D) 26MM</p> <p>2</p>	<p>4073 18</p> <p>A) 12MM-1.75 x 30MM B) 15MM C) 45.0MM D) 25MM</p> <p>2</p>
<p>19</p>	<p>20</p>	<p>21</p>	<p>22</p>	<p>23</p>	<p>24</p>

