



AMERICAN ARCHERY CO.

INDEX PAGE

ARCHERY SETS15

ARROWS

- Aluminum 6
- Fish13
- Glass 7
- Target6, 7, 11, 12
- Hunting6, 7, 11
- Field 6, 7, 11, 12
- Flu-Flu12
- Target 6, 7, 11, 12

BOOKS22

BOOMERANGS15

BOWS

- Barracuda 5
- Cheetah Supreme 2
- Cheetah Special 4
- Cheetah Standard 4
- Deluxe AMARCO 3
- Flash 5
- Shark 5
- Special AMARCO 3

CLOTHING23

FLETCHING 8, 9, 10

- Die Cut20
- Feathers20, 21
- Plastic Vanes20

GAME CALLS23

GLASS BOWS14

HANDWARMERS22

LEATHERS GOODS

- Arm Guards16, 17
- Bow Cases20
- Bow Quivers22
- Finger Tabs17
- Ground Quivers20
- Shooting Gloves17
- String Holders22

RAW MATERIALS

- Cements21
- Nocks21
- Points 6, 7, 11, 12
- Shafts 6, 7, 21
- Feathers 20, 21

SHOOTING AIDS

- Arrow Holders20
- Arrow Rests20
- Bowsights19
- Bow Slings17
- Brush Buttons20
- Glove Powder22
- Nocking Points20
- Stabilizers19
- String Silencer22
- String Wax20
- Tip Protectors20

SLING SHOTS15

STRINGS

- Dacron22
- Hemp22
- String Servers22
- Thread19

TARGETS18

- Stands18
- Target Mats18
- Score Cards18

TOOLS

- Arrow Clips21
- Feather Trimmers21
- Fletching Jigs21
- Sharpeners22
- Tapering Tools21

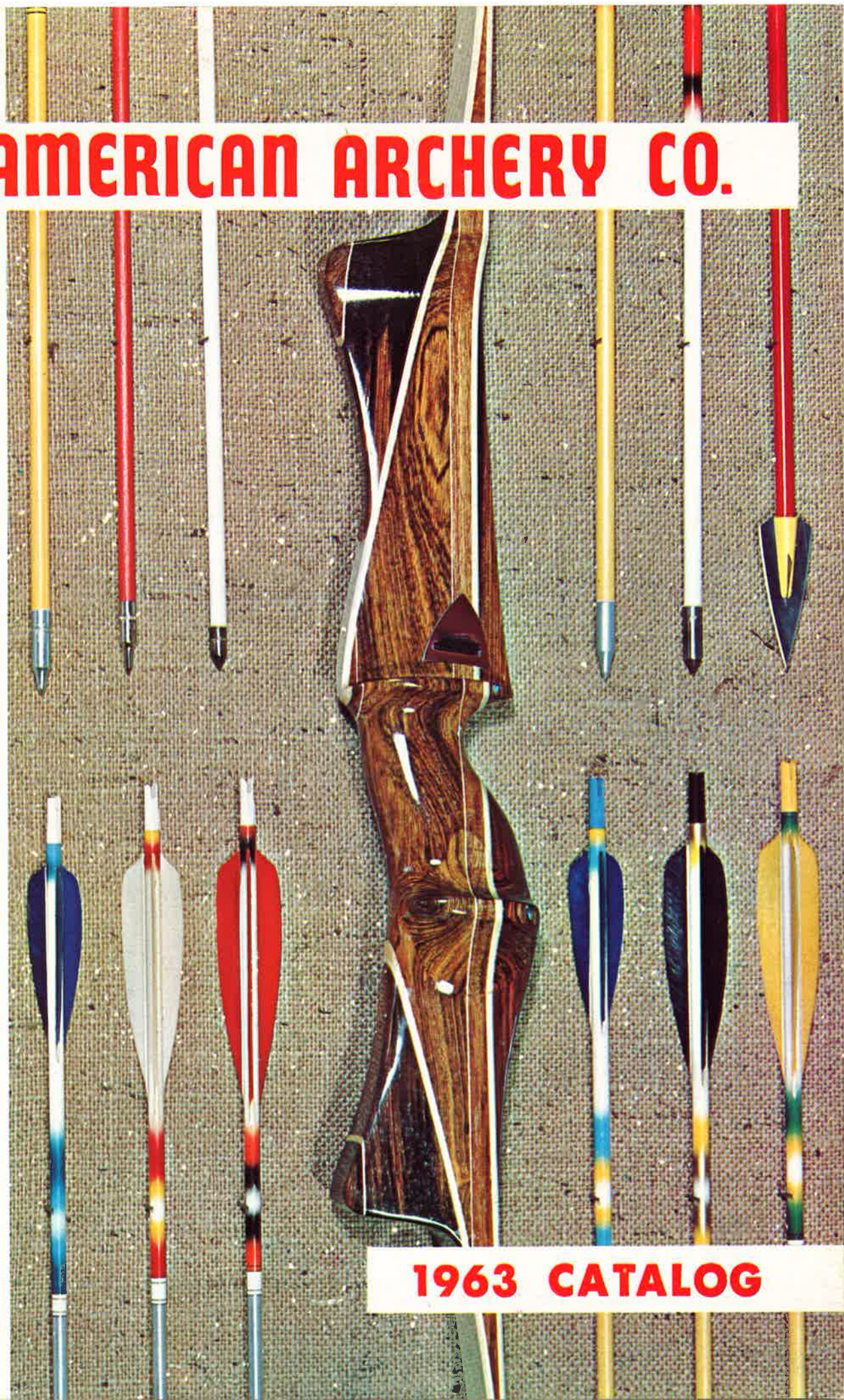

1963 CATALOG



SUPREME

This masterpiece of the bowyer's art stands alone in the field of fine bows. It simply cannot be compared with any others.

Tournament-wise champions choose this bow for its "built-in" stabilized design. The automatic palm and thumb rest assures precise and accurate control of every shot! The beautiful imported hardwoods impart weight and reduce torque to almost nothing.

Made in three lengths-

- 66" CS125.00
- 68" CS125.00
- 69" CS125.00



- BALANCE
- BEAUTY
- STABILITY
- ACCURACY
- SMOOTHNESS
- POWER
- SPEED

Compare any American bow with others for the outstanding qualities that every particular archer demands — and you'll come up with just one answer. There are no other bows made that are so full of "BUILT-IN" VALUES!



BOB PENDER

1962 NAA Professional Target Champion adjusts his sight on the Deluxe Model 1963 AMARCO.



"DELUXE" AMARCO

Has that extra "something" that makes it the favorite bow of many champion archers. Take a look at the beautiful contoured handle that positions your bow hand exactly the same every time!

Made in 4 lengths -

- 64" AD95.00
- 66" AD95.00
- 68" AD95.00
- 69" AD95.00

SPECIAL AMARCO

Those who like the standard type grip will find this model ideally suited. All the meticulous craftsmanship that American bows are famous for - makes this bow "on Target" every time.

Made in 4 lengths -

- 64" AS84.50
- 66" AS84.50
- 68" AS84.50
- 69" AS84.50



....AMERICAN ARCHERY COMPANY



....AMERICAN ARCHERY COMPANY

Cheetah

HUNTER'S SPECIALS

PROVEN BY PERFORMANCE

In your hands - on the hunt - from the bush - from the tree - from the boat - standing - kneeling - sitting - here are the bows that deliver maximum power for every shot! Here are the bows where you can see the difference in fine craftsmanship. Here are the bows where you can feel the difference. When it counts most - why settle for less than the best. Choose a Cheetah Special in any of the four lengths.

- 57" C69.50
- 60" C69.50
- 64" C69.50
- 66" C69.50

STANDARD CHEETAH

Here is our famous original Cheetah all dolled-up in the most handsome hardwoods and finest appointments. No other bow in this price range has so much "built-in" value.

- 64" CH55.00

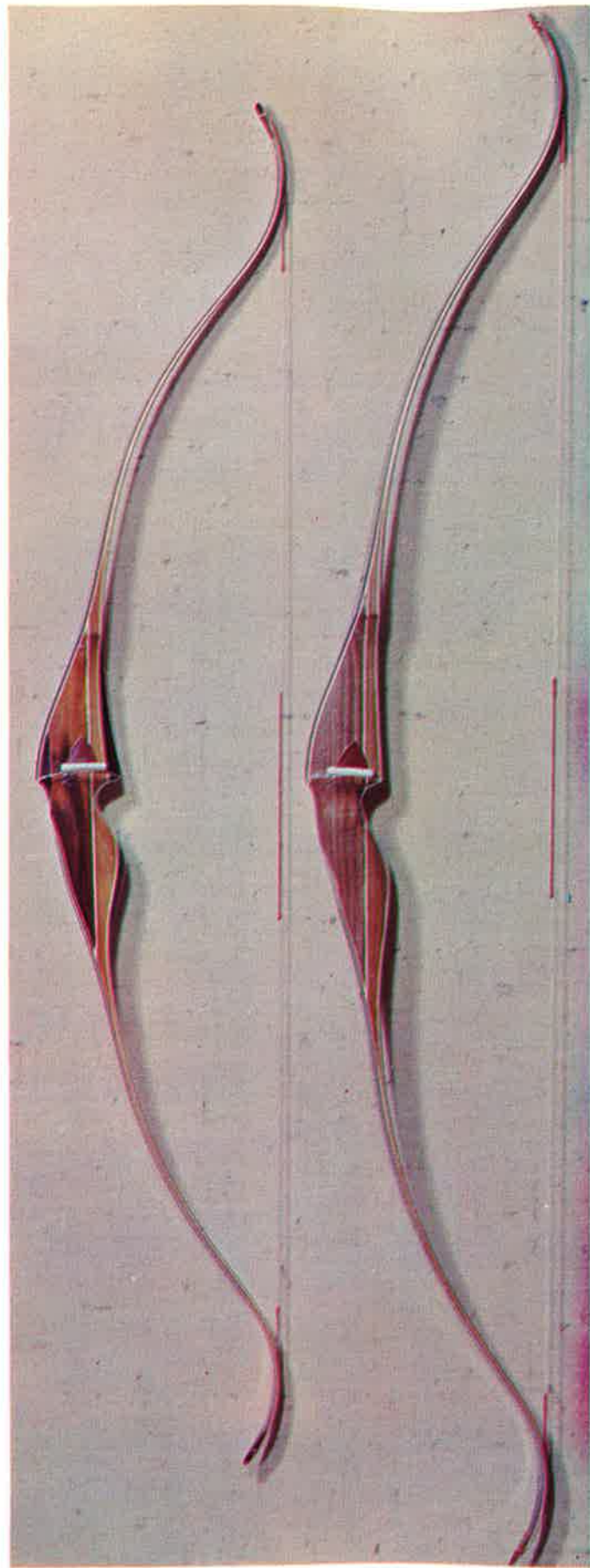

Barracuda

Accent on quality at lower prices! Made especially for the bowhunter who wants dependable performance in a bow that shoots and looks like one costing much more. Short, fast and stable - it meets with instant approval.

- 57"49.50

Shark

Made with the same high grade materials as our finest bows - the Shark has a wide variety of use - short enough for good hunting - long enough for smooth shooting - it speaks value in a language every archer can understand and appreciate.

- 62"44.00

FLASH (not shown)

For the archer where economy comes first.

- Flash 62" 25 to 40 lbs.....37.50
- Flash 61" 20 to 35 lbs.....24.95

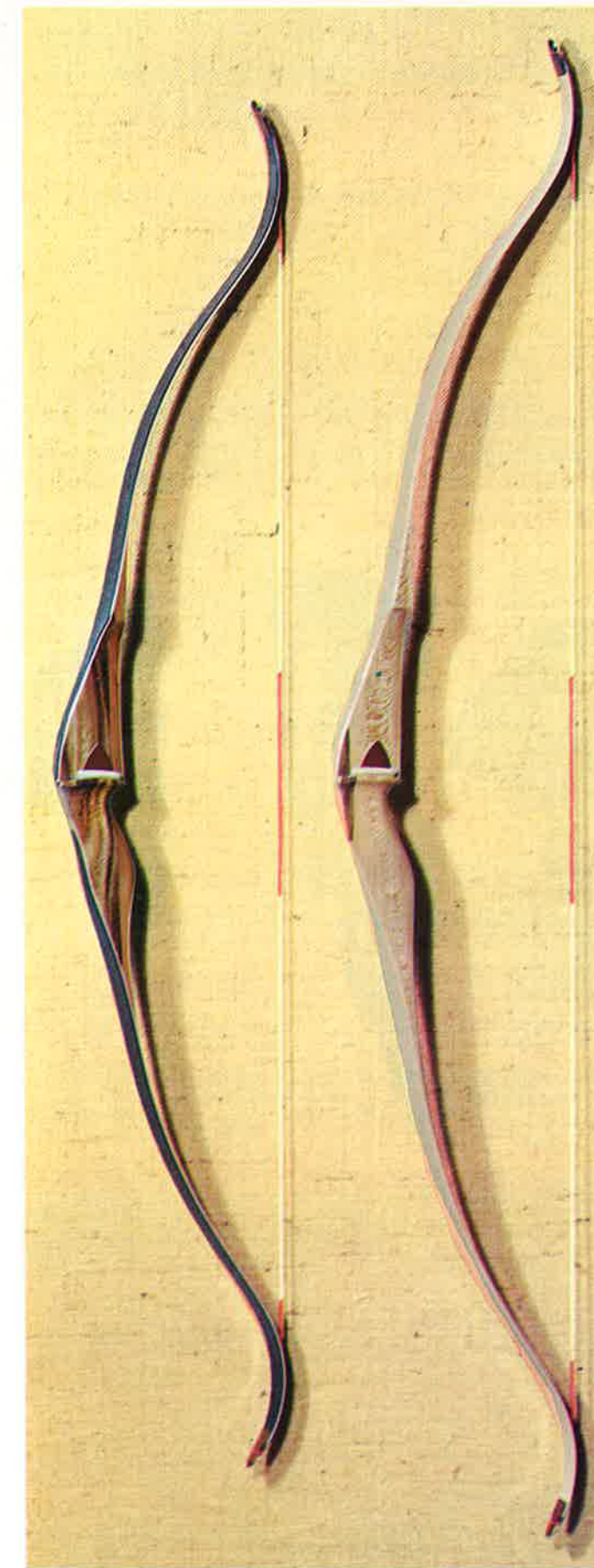

....AMERICAN ARCHERY COMPANY



....AMERICAN ARCHERY COMPANY

Aluminum Arrows

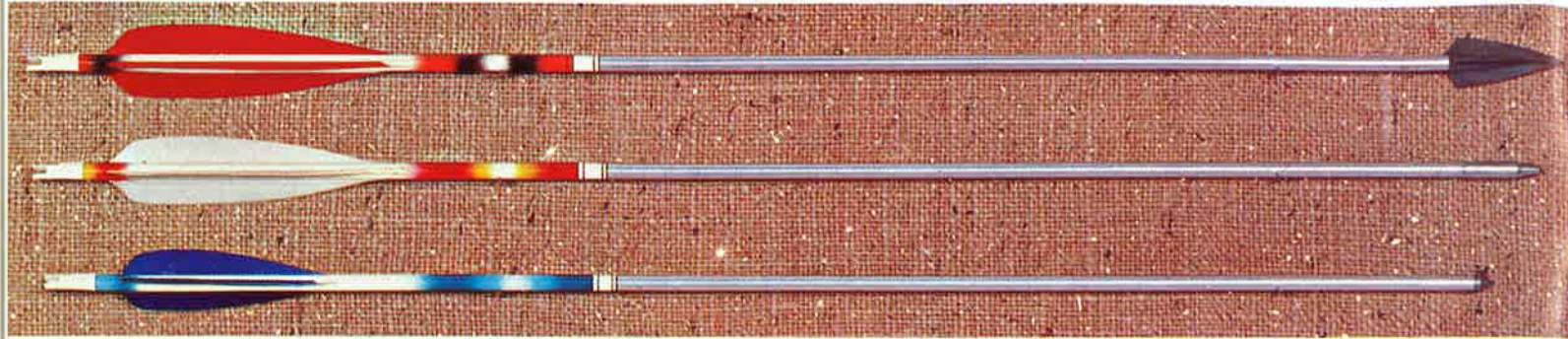

Order No.	Target Points Or Adaptors	Field Points Non-Skid	HUNTING *Choice of Broadheads	Cut to length With points Installed	31" Shafts With points Unattached	Target Inserts Only	Broadhead Adaptors Only
	PMA-T	PMA-F	PMA-H	ES-1	ES-2	E-IP	E-BA
24-SRT-X	29.50	30.00	32.00	22.00	20.80	3.80	2.40
XX-75	34.50	35.00	37.00	27.00	25.80	3.80	2.40
A-100	21.95	23.50	25.45*	17.30	15.50	3.80	2.40

* Bear Razorheads - With single blade #5 - 1.00 extra - With auxiliary blades - 2.50 extra

You'll have the world's most efficient tournament arrows when you get American "Air-Flo" fletching combined with any of the three famous Easton aluminum shafts.

24-SRT-X - Have been the standard of quality since 1946 - All National Championships, recorded perfect ends, five consecutive six-golds at 40 yards are some of the accomplishments of archers shooting 24-SRT-X.

XX-75 - The extremely high strength of 7075 alloy is further increased by many Easton operations to an ultimate strength of 101,000 psi, as much as 20,000 psi over the listed ultimate strength. This increase in strength gives XX-75 its amazing bend resistance and spring qualities.

A-100 - This aluminum shaft is a better, straighter, stronger and better finished shaft than any competitive tube. It is machine straightened to within .010 per foot with a weight tolerance of plus or minus .0002. Sizes run through 1416 to 2020. No thin wall is made in this shaft.

ORDERING INSTRUCTIONS - Write for special charts giving all the sizes of Easton Tubing. Or specify the exact arrow length and bow weight and we'll give you a perfect match. Be sure to tell us any special fletching or cresting that you desire.



POSITIVE IDENTIFICATION

You can be sure that you are using genuine Easton shafts when you see the trade-mark and shaft number that is etched on every tube - look for this marking when you buy.

USE THIS CHART TO HELP SELECT THE RIGHT ARROW SHAFT FOR YOU

DRAW LENGTH SHOWN - is for actual draw length from the inside of nock to the shoulder of point.

FIELD AND HUNTING ARROWS - using heavy weight tips, should use the equivalent draw length for 2" longer draw.

BOW WEIGHTS	POPULAR ALUMINUM SHAFT NUMBERS				
	26"	27"	28"	29"	30"
30 lbs. to 35 lbs.	1616	1618	1716	1816	
35 lbs. to 40 lbs.	1618	1716	1718	1818	1818
40 lbs. to 45 lbs.	1716	1718	1816	1818	1916
45 lbs. to 50 lbs.	1718	1816	1818	1918	2016
50 lbs. to 55 lbs.	1816	1818	1916	2016	2018
55 lbs. to 60 lbs.	1818	1916	1918	2018	2020
60 lbs.	1818	1820	1918	1920	2020

Glass Arrows

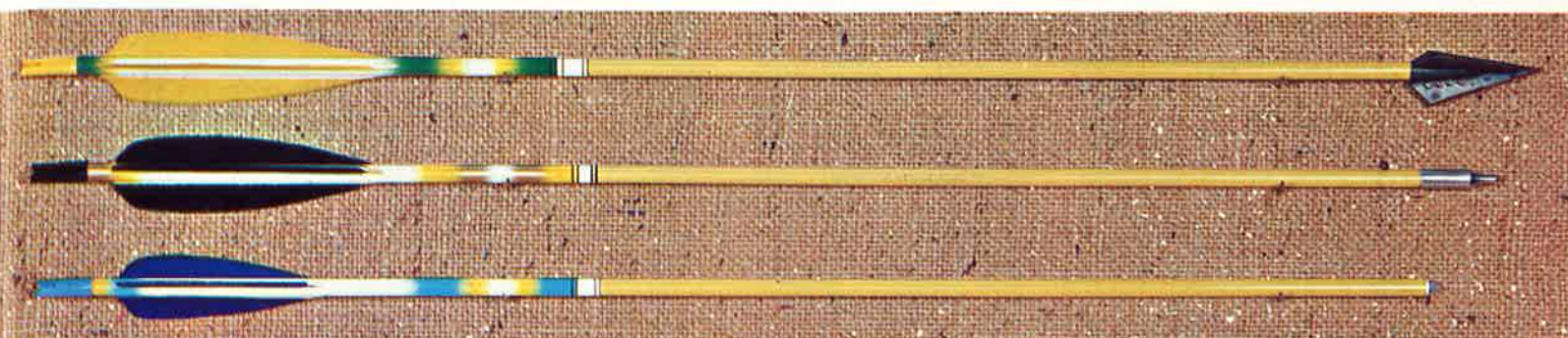

PROFESSIONAL GLASS ARROWS - Made with "Micro-Flite" Glass Tubing

Order No.	TARGET Points or Adaptors	FIELD Non-skid Points	HUNTING *Choice of Broadheads	COMBINATION 6 Hunting 6 Non-skid	CUSTOM GRADE	TARGET POINTS
	GA-1	GA-F	GA-H	GA-CH		GA-C
	25.95	27.50	29.50	28.50		29.50

* Bear Razorheads - With single blade #5 - 1.00 extra - With auxiliary blades - 2.50 extra

Electronics and fabulous fiber glass have combined to make the ultimate arrow! They are permanently straight and never take a warp or set even though they encounter head-on impacts which would shatter or bend ordinary arrows. Tiny filaments of glass are woven into glass cloth - impregnated with plastic resins and wound around a cylindrical shape to form a tube. Diameters and straightness are checked electronically - thus producing the famous "Micro-Flite" shafts.

ORDERING INSTRUCTIONS - Your choice of above arrows, sets, or shafts will be custom made to fit your requirements. Select the shaft number you wish from the chart below - or give us the draw weight and arrow length and we'll select exactly the right shaft for your needs.

TARGET POINT

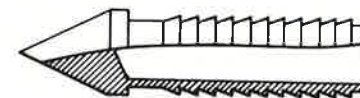

BROADHEAD INSERT

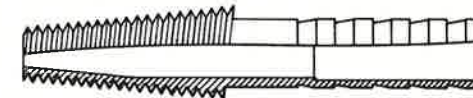

NOCK INSERT

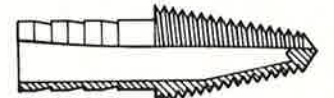

10 DIFFERENT SIZES

There is a "Micro-Flite" shaft that will exactly fit your needs. Each of the ten sizes is made to minute tolerances in weight and spine.

USE THIS CHART TO HELP SELECT THE RIGHT ARROW SHAFT FOR YOU

DRAW LENGTH SHOWN - is for actual draw length from the inside of the nock to the shoulder of the point.

FIELD AND HUNTING ARROWS - using heavy weight tips, should use the equivalent draw length for 2" longer draw.

BOW WEIGHT	POPULAR GLASS SHAFT NUMBERS				
	26"	27"	28"	29"	30"
30 to 34 lbs.	2	2	3	4	5
35 to 39 lbs.	2	3	4	5	6
40 to 44 lbs.	3	4	5	6	7
45 to 49 lbs.	4	5	6	7	7
50 to 54 lbs.	5	6	7	7	8
55 to 59 lbs.	6	7	7	8	8

IMPORTANT INFORMATION

The proper selection of arrows is more important than any other part of your archery equipment. For consistently good shooting, be sure that your arrows are matched exactly to you and your bow.

At American Archery we have spent a lifetime studying the dynamics of how an arrow works to peak perfection. We have tens of thousands of Port Orford Cedar shafts that we carefully grade and inspect, before allowing any shaft to become an American arrow.

To get the fullest advantage of value in your arrows make sure that they fit you and your bow.

THREE-BLADE

Hunting-Practice Field Point to match broadhead

BLUNT

Target-Field point

INSERT TARGET POINT

Note: Arrow length is measured from bottom of nock slot to this point.



PLASTIC 6 FLETCH

1. For advanced archers - available in 3 and 4 vane fletch in short and target lengths.

90° FOUR FEATHER

2. 90° four feather fletching is the same as the regular Helical fletch except that the vanes are not spiraled around the shaft.

105° 75° 4 FEATHER

3. 105°/75° four feather fletching is spaced so that the feathers closest to the bow handle are farther apart thus creating less feather drag at this point.



3 FEATHER

HELICAL FLETCH

Available for any type of arrow - wood, metal or glass - many like this type of fletching because they feel that it gives the benefits of 4 feather helical fletching plus a little extra distance. Vanes are usually cut a little higher on three feather helical fletching to give better vision and stability in flight.

WOOD ARROWS

Barred 3 feather Helical fletching\$.50 doz. extra
All white or dyed white
3 feather Helical fletching..\$1.25 doz. extra

METAL AND GLASS ARROWS

Dyed or barred 3 feather
Helical fletchingNo extra charge

AMERICAN AIR-FLO FLETCHING

Costs no more than ordinary fletching yet it gives you many added advantages.

1. SMOOTHER FLIGHT

On all types of fletching from American the vanes are scientifically shaped to allow the passage of air on the vanes without curling them. The vanes are rounded off on the ends to enable the feather to maintain proper shape in flight.

2. BETTER SCORES

By using only the very best grades of barred and white turkey feathers for the fletching and attaching them with the finest fletching cement and drying the bond with "infra-red" heat - American gives you arrows that will "group" better and result in higher scores in field and target and better success in hunting.

3. WIDER CHOICE

There is a fletching style to suit every archer and bowhunter. With six basic types of fletching and feather lengths to suit various bow weights - you have a wider choice of fletching on American arrows. The following recommendations for feather lengths and styles are based on years of experience and testing.

You select the style of fletching you want on your arrows and tell us the length of the arrow and bow weight. We will then fletch your arrows according to the following chart of spines and feather lengths.

WOOD ARROWS

Bow Weights	Feather	Length
Up to 35#	Short	3"
36 to 45#	Medium	4"
46# and over	Regular	5"

ALUMINUM ARROWS

Shaft No.	Feather	Length
1416, 1516, 1518	Extra Short	2 1/2"
1716, 1718	Short	3"
1816, 1818	Med. Short	3 1/2"
1916, 1918, 1920	Med. Regular	4 1/2"
2020	Regular	5"

GLASS ARROWS

Shaft No.	Feather	Length
1	Short	3"
2, 3	Short	3"
4, 5	Med. Short	3 1/2"
6	Med. Regular	4 1/2"
7 to 10	Regular	5"



4 FEATHER HELICAL FLETCH

4 feather Helical fletched arrows are the favorites of thousands of experienced field-target and bowhunters. They fly straight and silently - allowing the archer to easily follow them in flight - thus they give higher scores in field and target shooting and increase the chances of the bowhunter's success.

WOOD ARROWS

Dyed barred - 4 feather Helical fletching\$1.00 doz. extra
All white or dyed white - 4 feather Helical fletching 2.00 doz. extra

METAL AND GLASS ARROWS

Dyed or barred 4 feather
Helical fletching50 doz. extra

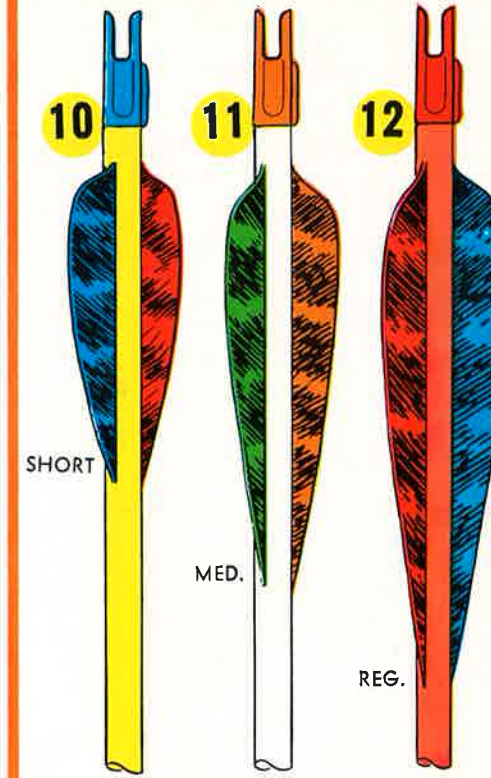

3 FEATHER REGULAR FLETCH

Regarded by many as the best fletching of all! We fletch these arrows with a vane that is parallel to the shaft and the natural camber of the feather does the rest. Unless your order states that you want some other type of fletching, we will use a regular three feather fletch based on the spine of the arrow.

WOOD ARROWS

Barred Regular fletching..... No extra charge

METAL AND GLASS ARROWS

Barred Regular fletching.....No extra charge

SELECTING CORRECT ARROWS FOR YOU AND YOUR BOW

Method 1

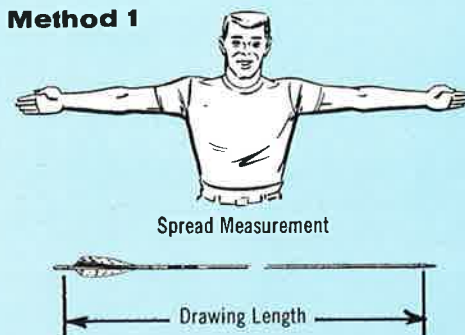

Spread Measurement	Arrow Length
57-59"	22-23"
60-62"	23-24"
63-65"	24-25"
66-68"	25-26"
69-71"	26-27"
72-74"	27-28"
75-77"	28-29"
Over 77"	30"

Method 2

Hold yardstick at center of chest as shown. Your draw is measurement at fingertips.

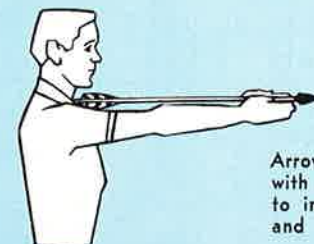
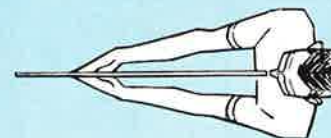

Arrows are fletched with precision care to insure accurate and stable flight.

Selecting correct arrows for you and your bow

There are two accepted methods used in finding your right arrow length.

Method 1 is illustrated on page 7. Simply spread your arms as shown, measure the spread and determine your arrow length according to the chart.

The second method is shown at left. Place the nock end of an arrow against the center of your chest and reach out on it with your arms extended straight in front of you. If the arrow is the correct length for you, it will extend to the end of the fingertips. Lacking an arrow, use a yardstick for this measurement.

When ordering arrows, specify the bow weight: 40 to 45 lbs., 45 to 50 lbs., etc., and the arrow or draw length.

AMERICAN

"MICROMETER-BARRELED" ARROWS

IMPROVE YOUR SHOOTING WITH HELICAL FLETCHING



FOUR FEATHER HELICAL FLETCH

Dyed or plain barred.....\$1.00 extra
All white or dyed white..... 2.00 extra

THREE FEATHER HELICAL FLETCH

Dyed or plain barred.....\$.50 extra
All white or dyed white..... 1.50 extra



EASY TO SEE - Helical fletched arrows are much easier to "follow-in-flight" -- you don't have to guess where you hit, whether you are shooting field, target or hunting.

STRAIGHTER FLIGHT - Added air pressure against the Helical vanes causes a faster rotation and makes your arrow fly much straighter. Helical fletched hunting or field arrows will not "plane" or wobble in flight.

INCREASES ENERGY - Ordinary arrows take longer to straighten out in flight, and thus lose energy. Helical fletched arrows straighten out in flight immediately after leaving the bow, thus increasing energy.

IMPROVES ACCURACY - Even the effects of a faulty release are largely overcome with Helical fletching. The faster turning shaft creates a dynamic balance. This is why 75% of the top archers are using Helical fletched arrows.

EXCLUSIVE - Beware of imitations! American Archery is the originator of Helical fletching. We have our own patented fletching jigs. There are many imitations but only one GENUINE HELICAL FLETCHING. Be sure that your arrows are made by American and have Helical fletching and you'll see a big improvement in your shooting.

What does "Micrometer-barreled" mean?

"Micrometer-barreled" is a patented American Archery feature wherein the ends of the shaft are tapered a few thousandths of an inch, leaving the center portion slightly stiffer. The back has a few thousandths more taper than the front.

What does this do for arrow flight?

"Micrometer-barreled" puts far better balance into the shaft, enabling it to react properly to the impact of today's high speed composite bows. It enables the shaft to bend just slightly more at the rear end, thus clearing the bow handle better - increasing accuracy and speed.

Are other arrows "Micrometer-barreled"?

No! Others have either extremely tapered shafts or parallel shafts. The ordinary tapered shaft bends too much and whips against the side of the bow. The parallel shaft does not bend enough and scraps against the bow. In both cases - accuracy and speed are lost.

Do "Micrometer-barreled" arrows stay straight longer?

You bet they do! That is just another reason why archers who use them find their scores going up and staying up! Ordinary cheap tapered arrows may work fine for a while - but after a few months use they will be crooked while the "Micrometer-barreled" arrows will still be straight. What's more they will stay that way for years.

Are "Micrometer-barreled" arrows balanced in weight and spine?

Yes, sir! No other manufacturer has such high standards as the American Archery Company. Although our tolerances are 10 grains in weight and 5 pounds in spine, we consistently match much closer than this because of our large scale production.

Can I check "Micrometer-barreled" shafts with a micrometer?

We hope you do! You will find that each dozen is perfectly round and has exactly the same controlled barreling as its mates. Now, check the shafts of any other manufacturer and you'll find that they vary up to ten thousandths of an inch in roundness and tapering!

Do "Micrometer-barreled" arrows cost more?

No! Even though they are the best arrows in the country, they actually cost less than many other top grades of other manufacturers. All grades of American arrows are "Micrometer-barreled" except the very cheapest beginner's practice arrows.

Which American Arrows are "Micrometer-barreled"?

All American arrows are "Micrometer-barreled" except the very lowest priced beginner's arrows.

SHAFT SIZES

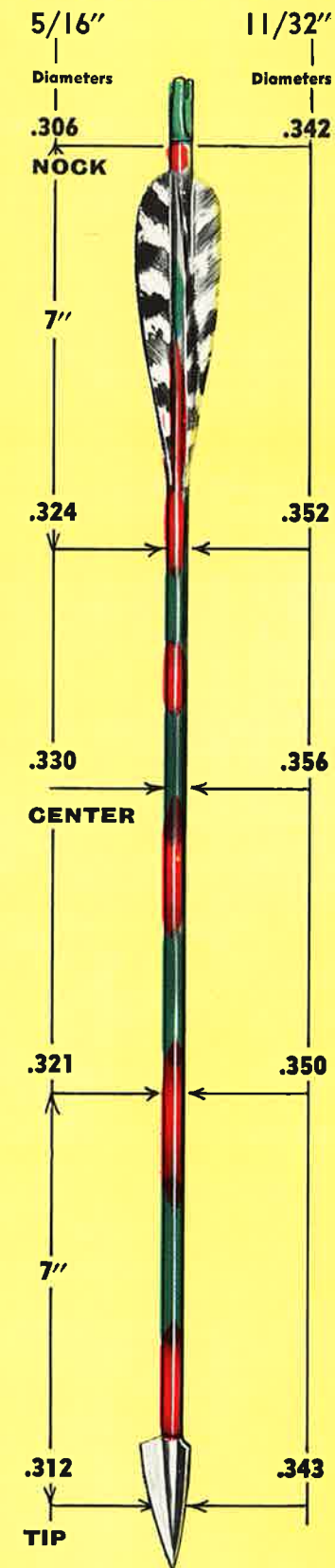

AMERICAN

"MICROMETER-BARRELED" ARROWS

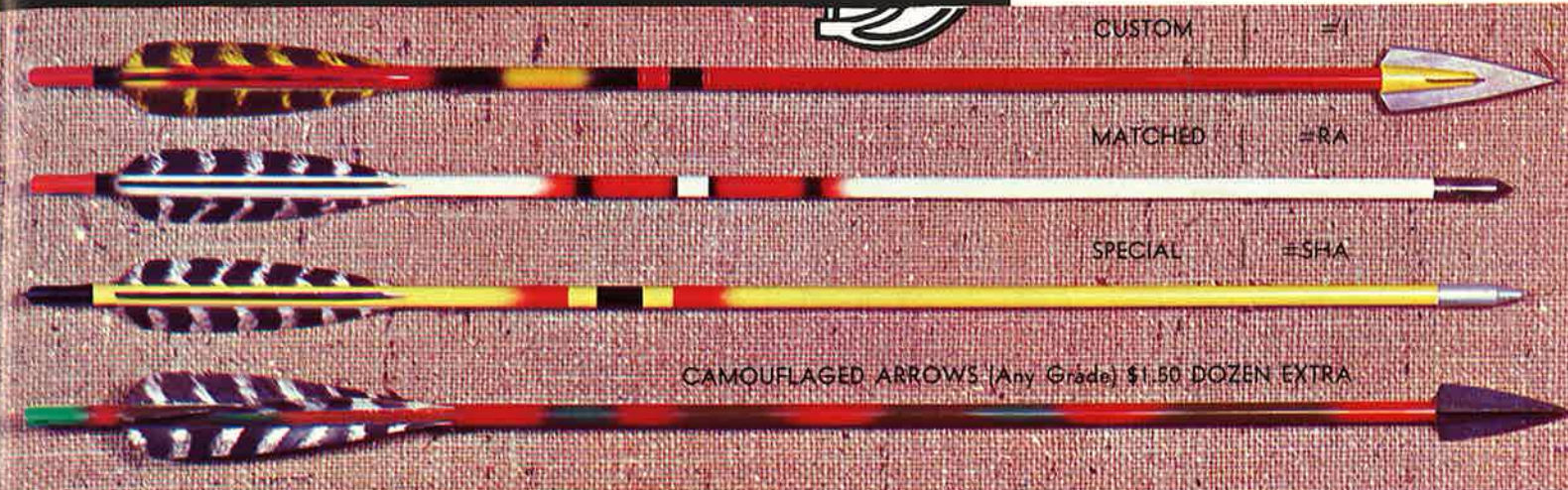

FAMOUS FOR HIGHEST QUALITY - AND LOWEST RETAIL PRICES!

All grades are matched in weight and spine to the highest standards in the industry! Every shaft is genuine Port Orford Cedar - laquer sealed to prevent warping. No matter which grade you buy you'll find them straight and true. You get far more quality for every penny when you buy American Arrows.

Type		HUNTING		RAZORHEADS		FIELD	TARGET	SANS HEADS		COMBINATION SETS	
		1, 2, 3, 4, 6	#5	#5-A	#NS	#TP	#Plain	#Taper	#CS	#5	#5-A
CUSTOM	#1	15.00	16.50	17.50	12.75	12.75	11.00	11.75	13.75	15.00	16.50
MATCHED	#RA	13.75	15.25	16.25	11.25	11.25	10.00	10.75	12.25	13.75	15.25
SPECIAL	#SHA	12.00	13.00	14.00	8.95	8.95	8.25	9.00	10.75	12.25	13.50

CAMOUFLAGED ARROWS - ANY GRADE..... 1.50 dozen extra

COMBINATION SETS - These special sets consist of 6 matching broadheads (your choice) and 6 matching practice arrows. They are ideal for every bowhunter.

WHEN ORDERING ARROWS - Be sure to specify the grade and code number - your choice of broadheads or field points - the drawing length (see chart on page 8) - the weight of the bow in which the arrows will be used (spine) - the diameter of the shaft (5/16" or 11/32") - and any special fletching or cresting you want. Almost all of these extras cost you nothing more and they will speed up your order and insure the greatest satisfaction. Be sure to order your hunting arrows early!

HUNTING - FIELD - TARGET POINTS - Specify the code number and diameter of the points you wish. The 5/16" broadheads and practice points weigh 100 grains and the 11/32" broadheads and field points weigh 125 grains. Each dozen points comes neatly packaged in plastic display boxes.

1 HI-PRECISION	2 ARROW-MATE	3 MA-3 BLADE	4 ARROW-MATE	5 RAZORHEAD	6 BODKIN "B"	HS - SMALL GAME HILLS HORNET
NS NON-SKID	TP TARGET	MB BLUNT	200NS NON-SKID	200NS BLUNT	RT TARGET	RB RUBBER

5/16" only

Code No.	HUNTING BROADHEADS							Parallel Wall PRACTICE POINTS				Interchangeable PRACTICE POINTS			
	#1	#2	#3	#4	#5	#5-A	#6	#NS	#TP	#MB	#RT	#RB	200NS	200B	Hill's
Per Dozen	3.75	3.50	3.75	4.50	4.25	5.50	3.75	.90	.85	.85	.35	1.80	.90	.85	3.75

....AMERICAN ARCHERY COMPANY

....MATCHED BROADHEADS AND FIELD POINTS....

AMERICAN *Quality* ARROWS

You won't find any crooked or warped arrows even in the lowest priced American Quality Arrows - and they are all made of genuine Port Orford Cedar - laquer coated to make them easy to find.

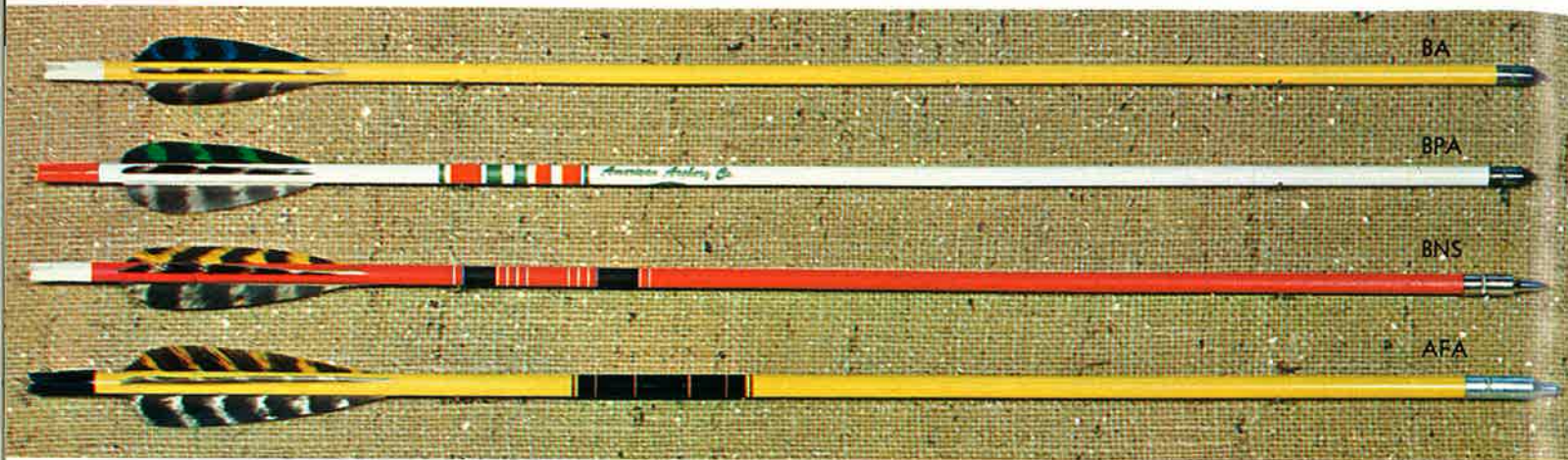

UNEQUALLED FOR QUALITY AND LOWEST PRICES!

Grade	Size	Code	DOZEN	SIX DOZEN		ONE HUNDRED	
				LOOSE	DISPLAY	LOOSE	DISPLAY
BEGINNER'S	5/16"	BA		18.00		25.00	
TARGET	5/16"	BPA	4.50	21.60		30.00	30.00
NON-SKID	5/16"	BNS	5.00	28.50		39.50	39.50
ADULT Non-Skid	11/32"	AFA	6.50		38.00		50.00
ADULT Helical Fletch	11/32"	AF3	7.00		41.75		55.00



LOOSE

ORDERING INSTRUCTIONS

Your choice of 24/26/28 lengths in the BA and BPA grades. Your choice of any assortment of 26 and 28 lengths in the BNS and AFA grades. We advise using 5/16" arrows for bows up to 40 lbs. and 11/32" arrows for bows over 40 lbs.



DISPLAY

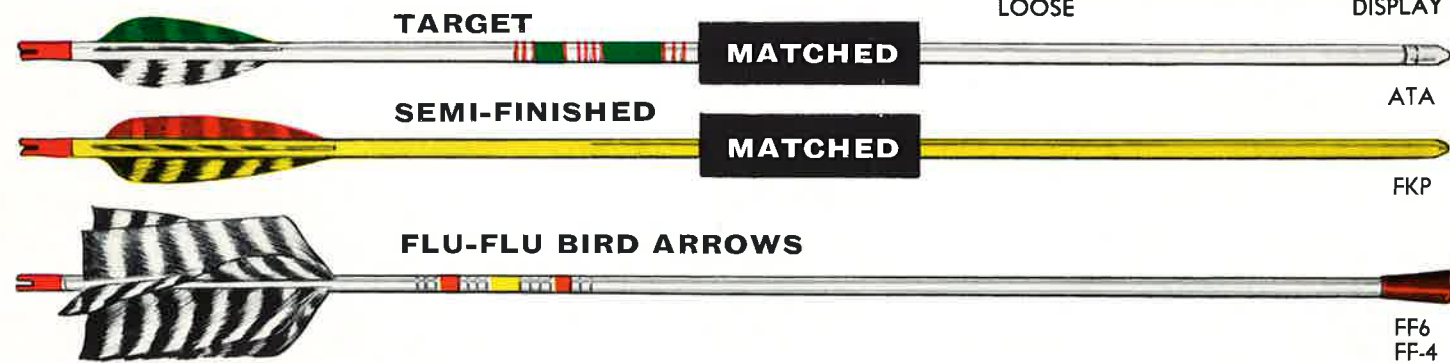

TARGET-ATA - Fine for schools and those wanting a good matched arrow at a very low price. Available in all lengths.
SEMI-FINISHED-FKP - This makes a good low-priced hunting arrow when the end is fitted with a broadhead. Specify weight when ordering.
FLU-FLU BIRD ARROWS - Give your choice of rubber or metal blunts. FF-6 is 6 feather helical - FF-4 is 4 feather helical. Either type is available in 5/16" or 11/32" size at no extra cost.

Grade	Size	Code	DOZEN BOX	SIX DOZEN
SEMI-FINISHED Hunting-Matched	11/32"	FKP	7.75	45.00
TARGET *Matched Sets	5/16"	ATA	8.50	50.00
FLU-FLU Bird Arrows	5/16"	FF6	1.50 each	
	11/32"	FF-4	1.35 each	

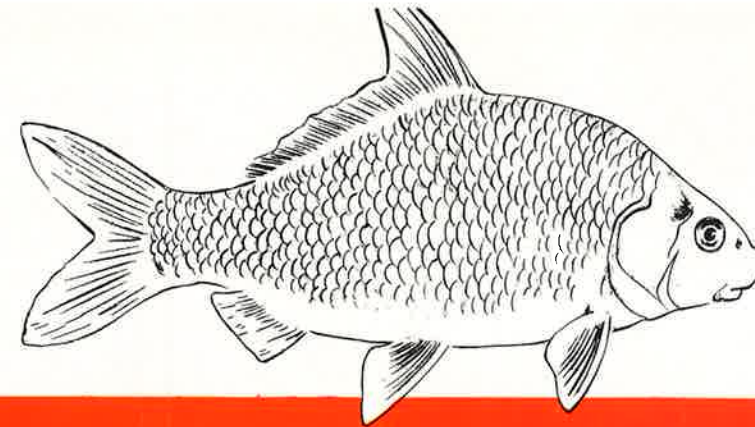

BOW FISHING EQUIPMENT

These fish arrows are vastly superior to any wooden fish arrows. The solid white fiberglass shafts weigh over 1,000 grains, thus giving more penetration in water and insuring greater success, less breakage and more fish. You'll land the big ones with heads we have provided for you.

- GFA-1** 30" white fiberglass shaft with 310 grain reversible single barb head - black rubber fletching..... **\$2.50 ea.**
 - GFA-2** 30" white fiberglass shaft with 180 grain double barb screw-off type head - black rubber fletching..... **2.50 ea.**
 - GFA-D** Deluxe fish arrow with new 480 grain narrow tip and reversible single barb - maximum efficiency in this one..... **3.50 ea.**
- Note: Any of above arrows may be had without rubber fletching for .25 less.
- GS** Plain glass shafts for making fish arrows..... **1.00 ea.**
 - LF** Rubber fletching for fish arrows 30c ea..... **\$3.60 doz.**



4" REEL AND LINE - Lightweight pressed aluminum - tapes to bow - includes 50 ft. of 80 lb. test line....MO-4 **\$2.95 ea.**

7" SHOOT THRU REEL AND LINE - Shoot right through the center of this one - faster shooting and retrieve - tapes to bow - with 50 ft. of 80 lb. line MO-7 **\$3.95 ea.**

6" LARGE REEL AND LINE - Larger size gives smoother line flow - tapes to bow - includes 50 ft. of 80 lb. test line. MO-6 **\$3.50 ea.**

FISH LINE - Spool of waterproofed fish line - 75 ft. - 72 lb. test. **FL** **\$1.25 ea.**
FL package of six spools..... **7.50**

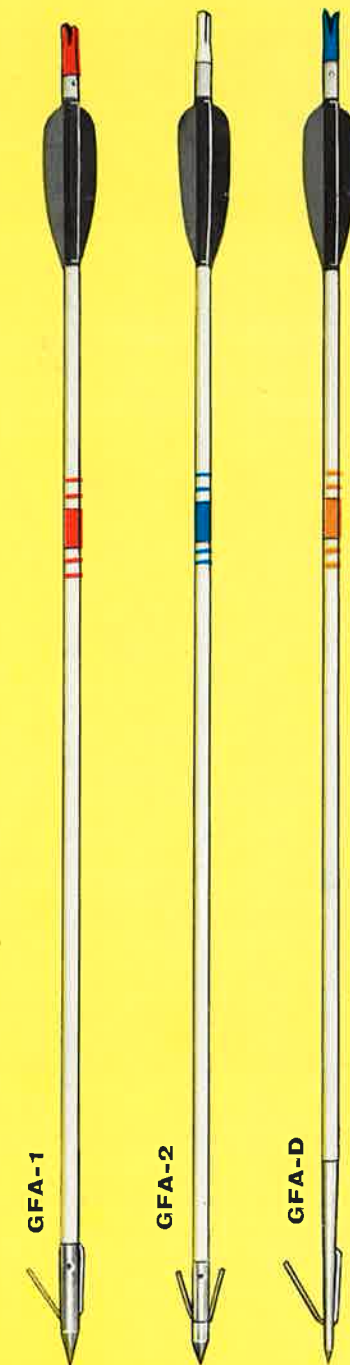

FISH HEADS

SBH - SINGLE BARB HEAD

Rustproofed parallel wall head with 5/16" hole - single reversible barb makes it easy to remove arrow from the fish - weighs 310 grains..... **\$.85 ea.**

DBH - DOUBLE BARB HEAD

Rustproofed and plated - the head un-screws from this one and allows the whole barb to be removed - 5/16" parallel wall hole - weighs 180 grains **\$.85 ea.**







DFH - NEW DELUXE FISH HEAD

Rustproofed and plated - large single barb is reversible and cannot be lost - narrow tip and extra heavy weight gives super penetration in water - 5/16" parallel wall hole - weighs 480 grains..... **\$1.75 ea.**..... **3 FOR \$5.25**

....AMERICAN ARCHERY COMPANY

....AMERICAN ARCHERY COMPANY

Solid FIBRE GLASS Bows

					
GB-1	GB-2	GB-3	GB-4	GB-5	GB-7
\$295	\$450	\$595	\$795	\$995	\$1295
40"	48"	48"	54"	56"	60"
10/15#	25#/24"	25#/24"	25/30# 26"	20/25# 25/30# 30/35# 35/40#	30/35# 35/40# 40/45#

Specify bow weight when ordering

GB-1 A fine bow for the juvenile robin hood from 3 to 6 years. Has wide arrow rest - 40" long - with hemp string. **\$2.95**

GB-2 CADET BOW - for ages 4 to 8 years - straight limbs for smooth shooting - 48" long - weighs about 20 lb. at 24" **4.50**

GB-3 JUNIOR BOW - for ages 7 to 10 years - recurved tips make this very popular - 48" long - weighs about 25 lb. at 24" **5.95**

GB-4 EXPERT BOW - for ages 7 to 13 years - recurved tips - longer length make this one very popular - 54" length - 25 or 30 lbs. **7.95**

GB-5 YOUTH'S BOW - see the choice of weights available above - this one is fine for schools - 56" length - double loop string **9.95**

GB-7 ADULT'S BOW - see the choice of weights above - this bow can even be used for the bowhunter - it is short, powerful and very durable. Makes a good first bow for the serious archer. **12.95**

COMPOSITE BOW STRINGS



The finest strings made. Made of special Type B Dacron - double loops - fully served at both ends and center - packed in re-usable plastic boxes. Specify bow weight and draw length - string length is length of the bow measured from nock to nock. This is usually marked on the side of the bow.

Your choice of the following sizes:
52, 54, 56, 57, 58, 60, 63, 64, 66, 67, 68, 69
DLBS Above strings, each..... **\$1.50**
2 for **2.95**

For perfect fit on American bows specify name, length and draw weight.

BOW STRING CHART

All lengths of double loop strings are made in 5 bow weights. Listed here are the number of strands used for various weights.

25 to 35# 8 strands 55 to 65# 14 strands
35 to 45# 10 strands 65 to 80# 16 strands
45 to 55# 12 strands

STRINGS FOR GLASS BOWS

Made of the same fine materials as the above, but have smaller loops for better fitting.

Your choice of the following sizes:
48, 50, 52, 54, 56, 58, 60, 66 lengths
GBS 2 for **\$2.95**

LINEN SINGLE LOOP STRINGS

For all bow weights and lengths. Center served and re-inforced at both ends for long life. Neatly coiled and packed with the bow length and bow weight marked on the package.



LS - 52/55 for 52" to 55" bows **\$1.40**
LS - 56/59 for 56" to 59" bows **1.40**
LS - 60/63 for 60" to 63" bows **1.40**
LS - 64/68 for 64" to 68" bows **1.40**
LS - 69/72 for 69" to 72" bows **1.40**

SPECIFY BOW WEIGHT WHEN ORDERING

SINGLE LOOP BOW STRINGS

Fit all bow lengths up to 60 inches not over 30 lbs.

HS - Each **.40**
Dozen **4.80**



DOUBLE LOOP BOW STRINGS

For any glass or wood bow up to 30 lbs. Made in four lengths - 48" - 50" - 52" - 54"

HDL Individually packaged, ea..... **\$.60**
Dozen **7.20**

Archery Sets FOR ALL AGES



AS-1 JUVENILE SET (for ages 3 to 6 years)
With GB-1 40" straight limb bow - four plastic tipped Cedar arrows - two target faces - plastic quiver - instructionsAS-1 **\$ 6.75**

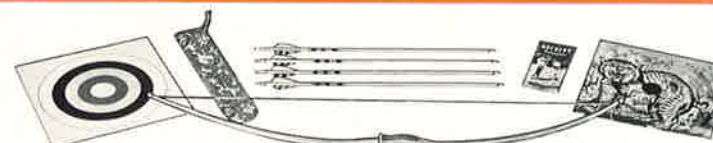

AS-2 CADET SET (for ages 4 to 8 years)
With GB-2 48" straight limb bow - four 22" Cedar arrows - plastic quiver - two target faces - instructionsAS-2 **\$ 7.95**



AS-3 JUNIOR SET (for ages 5 to 10 years)
With GB-3 48" recurved fibre glass bow with center shot design - four 24" Cedar arrows - two target faces - instructionsAS-3 **\$ 8.95**



AS-4 JUNIOR EXPERT SET (for ages 7 to 13 years)
With GB-4 recurved fibre glass bow with center shot design 54" long - four 24" Cedar arrows - arm guard - finger tab - two target faces - instructions.....AS-4 **\$10.95**

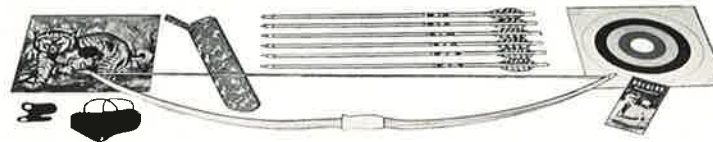

AS-5 YOUTH'S ARCHERY SET (for ages 10 and up to adults)
With GB-5 56" straight limb fibre glass bow (your choice of 20-25 lb. - 25-30 lb. - 30-35 lb. or 35-40 lb. bow weights) - six 26" Matched Cedar arrows - arm guard - Cordovan finger tab - two target faces - instructionsAS-5 **\$13.45**

Flight Tested BOOMERANGS



SENIOR MODEL

5 oz. Senior Model made from a special laminated waterproof wood to permit an unusual amount of abuse. Includes special instruction sheets.

5B 5 oz. Boomerang..... **\$ 2.00**
Carton of 12..... **24.00**

JUNIOR MODEL

2 1/2 oz. Junior Model - made so that any 10 year old child can get perfect results. Finest workmanship guarantees 100% satisfaction. Easy to follow instructions included.

2B 2 1/2 oz. Boomerang..... **\$ 1.50**
Carton of 18..... **26.00**

SLING-O-MATIC

AUTOMATIC SLINGSHOT

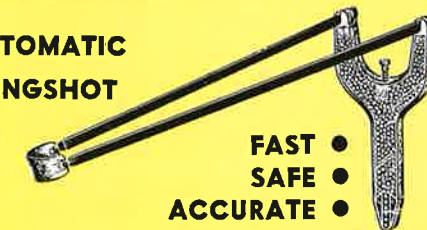

FAST ●
SAFE ●
ACCURATE ●

Self-contained magazine with a capacity of at least 500 standard BB's. Automatically feeds BB's one at a time - directly into leather pouch. Will also handle larger shot, ball bearings, etc.

SS - SLING-O-MATIC SLINGSHOT..... **\$1.50**
PP - Extra Pulls and Pouches..... **.50**

SAUNDERS WRIST ROCKETS

SUPER POWER

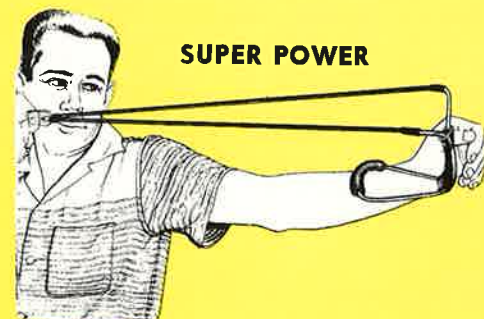

Wrist locking features means extra steadiness, extra accuracy and extra power. Drops rabbits, rats or other vermin with deadly accuracy. 3 MODELS TO CHOOSE FROM

WR-1 General 25# pull..... **\$2.95**
WR-2 Hunter's 35# pull..... **2.95**
WR-3 Junior 15# pull..... **2.95**
RR - REPLACEMENT RUBBERS..... **.50**
PL - Bag of pellets..... **.98**



....AMERICAN ARCHERY COMPANY

....OUTSTANDING VALUES FOR THE YOUNGSTERS....

AMERICAN

Quality Leather Goods



NEW! POCKET SIDE QUIVER

Holds 12 arrows easily - has divider - handy side pocket holds score cards - pencils - extra items - adjustable side straps make perfect carrying angle possible every time.

23-N - Side Quiver.....\$5.75
23-P - Deluxe Model..... 8.45

Deluxe Model LARGE SHOULDER QUIVER



Premier grade - 9 1/2 inches across top - 22 1/2 inches deep - 3 compartments - very large zippered pocket - knife, file and pencil scabbards - lasts a lifetime.

30 - DELUXE\$21.95

CENTER BACK QUIVER

The ultimate in center back quivers - 8 inches across top - 20 inches deep - 3 large arrow compartments - large zippered pocket - knife scabbard.

30-C Center Back \$16.95
30-M Special Model 16.95



MEN'S TARGET

Holds 6 to 8 arrows - 17 inches deep - 2 inch circumference - ideal for indoor or outdoor archery.

21-M\$3.75



LADIES TARGET

Same as above - with belt and buckle.

21-W\$4.50
21-WW all white..... 4.75
All white target ensemble - glove - arm guard - quiver.
21-WWE all white.....\$8.50



SHOULDER QUIVER

Made of smooth brown suede material - 15 inches deep - 5 inch oval top - with leather trim and shoulder strap - nice style at a popular price.

SQ\$2.50



ECONOMY QUIVER

Heavy, forest green plastic material, molded leather bottom, leather belt loop holds 6 to 9 arrows.

22-L\$1.50



JUNIOR QUIVER

Same as the above quiver - except it is slightly smaller - holds 4 to 6 arrows - hangs from belt loop.

22-S\$1.25



ESSENTIAL ACCESSORIES

DELUXE POWDER POUCH

Keeps glove powder instantly available at your side. Holds score and pencil - easy to re-fill. Made of durable leather and plastic.

PP - Powder Pouch.....\$2.00



LARGE BELT POUCH

For those archers who never have enough pocket room - chrome-tan cowhide - 8 x 5 x 3 inches.

LBP\$6.00



SHOULDER GUARD

Eliminates string-fouling - improves shooting - adjustable to any size.

SG brown\$3.25
SGW white 3.50



DOUBLE POCKET

Two arrow compartments - heavy cowhide back - extra snap-fastening pocket for strings, etc. - snap belt loop.

24-P\$2.95



BOW SLING

Adjusts to any shooting position - automatic tension at all times - 3 sizes - Large Medium, Small.

ABS\$1.50



SCORE CARD HOLDER

Holds score cards out of the way - with steel clips - 5 1/2" leather loop fits through belt with snap fastener.

SCH only\$.50
SCH dozen 6.00



ALL TYPES OF ARM GUARDS

HUNTER - STRAP

Metal buckles and strap - metal re-inforced - fits over hunting clothes - our best.

14-S\$3.25



HUNTER

Same as above guard - except it is equipped with 3 elastic straps and hook fasteners.

14\$2.75



TARGET

Metal re-inforced - smooth suede leather lining - high gloss front - elastic straps.

17\$2.00



FIELD

Gives extra wide protection - three rubber cords snap into place for adjustable fitting.

15\$2.00



PLASTIC

Same general design as No. 17 target guard - made of tough, pliable plastic material.

18-P\$1.00



JUNIOR

One piece leather guard - two rubber cords snap into hook fastener - very adjustable.

18-A\$.75



Shooting Gloves Finger Tabs

PRO - SINGLE SEAM

Cordovan - for fast releases Elastic wrist - State size - Small, Medium Small, Medium, Medium Large, Large, XL.

PRO\$2.75



SINGLE SEAM

Leather - no finger pinch elastic wrist - Small, Medium, Medium Large, Large, XL.

19-S State sizes.....\$2.50



MOLDED TIPS

Leather - one piece back - Small, Medium Small, Medium, Medium Large, Large, XL.

19-L State sizes.....\$1.75



MARSHALL TYPE

Shell cordovan - backed with soft suede - for smooth releases.

20-M Double\$1.00
20 Single50
Sizes: Small, Medium, Large.



HAIR TAB

Cordovan backed - resists sweaty fingers - best for hot weather shooting.

HT Suede backed 1.50
Sizes: Small, Medium, Large.



KANT-PINCH TAB

Special finger insert prevents pinching of the arrow - improves shooting - made just like the Marshall Tab with extra features. Sizes - Small, Med. Large.

KP\$1.50



JUNIOR LEATHER TAB20-A .25

Silent Stalker

HIP HUNTER

Holds 8 arrows absolutely quiet and free of brush. Keeps your broadheads deadly sharp and instantly available! Extremely light weight and fully adjustable, yet it will last a lifetime. Made in black only - of top quality cowhide re-inforced with spring steel.

HHQ - Hip Hunter \$9.95
Matching belt for above 1.95



POCKET SHOULDER QUIVER

Handcrafted from the finest quality leather - 8 inches across top - 20 inches deep - holds plenty of arrows - a quiver any archer would be proud to own.

30-R\$10.95



THE ROVER HIP QUIVER

For roving or target archery - large accessory pocket - hold 6-8 arrows at proper angle for fast draw - sturdy, tough, Beaver grain split cowhide - arrow divider.

HQ - Black or brown hip quiver only.....\$5.25
HQB - Matching belt for above quiver..... 1.95



.... AMERICAN ARCHERY COMPANY

.... SMARTLY STYLED LEATHER GOODS

ARROW RESTS

Brush Rest

Eliminates arrow deflection and gives truer flight. Takes only seconds to install on any bow.

AR Brush Rest...ea. \$.85



90° Feather Rest

Softer than the brush rest but very durable. Has a double arrow plate and double feather cushion.

TFR - Target Rest ea. .75



Flexible Plastic

Self adhesive - long wearing - small extra arrow plate gives better arrow clearance and flight.

FPR - Flexible Rest ea. .50



Feather Rest

Very popular with bow hunters who want noiseless flight and rugged service. Self-adhesive type.

FR - Feather Rest ..ea. .50



BOW STRING WAX

This special formula wax keeps strands together and lengthens string life. Comes in a neat mess-free plastic container.

BW Each.....\$.35
Dozen 4.20



STRING SERVER

Re-serving the bowstring is fast and easy with this simple tool. Thread colors available in orange, scarlet, green and copper.

SS - Complete ... \$1.50

Extra spools45

ES Easton Nylon Thread.....\$.65



BRUSH DEFLECTORS

This simple device will brush proof your bow - prevent twigs and weeds from snagging between the string and bow tip - soft, pliable rubber slides over string.

BB - S Super size .70

BB - Dozen 8.40



NOCK RITES

Eliminate the need for a glove or tab while it holds the arrow in the proper string position. Pliable, soft rubber - slides over string.

NR One pair. \$ 1.00

Dozen 12.00



NOCK LOCKS

Increase accuracy because the arrow is in the same position for every shot. Hold firmly at any tension desired. Also very useful for "kisser" on bowstring to insure proper anchor point.

NL One pair \$.50

Dozen card 6.00

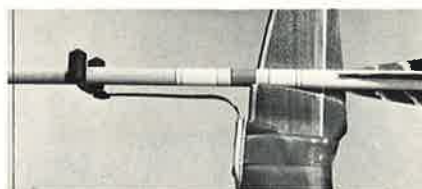

NELSON ARROW HOLDER

Keeps your arrow ready for instant shooting in any kind of weather - when the arrow is drawn back it automatically releases tension and drops out of the way. No noise - smooth and silent - made of spring steel and rubber.

AH - Neatly packed.....\$2.00

JIFFY CLIP

Fastens to any bow - for fast attachment or removal of the Nelson Arrow

JC - Jiffy Clip..... 1.00

BOW TIP PROTECTORS

Holds the string in place on the bow tip - keeps it from slipping off during stringing of the bow - it can save costly accidents. Also protects the beauty and finish of the bow tip.

BTP Each50

1 Dozen6.00



METAL GROUND QUIVER

For those who enjoy target shooting and regulation rounds - this handy item is a must. It holds your bow while you go up and retrieve your arrows. Also has a side quiver for holding spare arrows. Made of heavy plated steel and will last a lifetime.

MGQ Each..\$1.95



AMARCO-NOX



MOST PERFECT NOCKS MADE

Most popular with bowhunters and target shooters because of the perfect fitting on glass, wood or aluminum shafts. Seven sizes: 9/32" - 1/4" - 17/64" - 9/32" - 19/64" - 5/16" - 11/32". Seven colors: red, yellow, blue, white, green, black and orange.

129 in cellophane envelope..\$.45 doz.
Per 100 \$2.50 Per 1,000 \$20.00

Specify one size and color in 100 lots - In 1,000 lots - 1 color - 4 sizes.

AMARCO-NOX CHART

These charts show the best sizes of AMARCO-NOX to use on various sizes of glass and aluminum.

"MICRO-FLITE"		"EASTON"	
Shaft No.	Nock Size	Shaft No.	Nock Size
0	1/4"	1416	7/32"
1 - 2	17/64"	1516, 1518	1/4"
3	9/32"	1616, 1618	
4 - 5	19/64"	1716, 1718, 1816,	17/64"
5 - 6	5/16"	1818, 1820,	
7, 8, 9, 10	11/32"	1916, 1918, 1920, 2016,	19/64"
		2018, 2020,	
		2114, 2219,	5/16"

ARCHERY CEMENTS

For use with heat in attaching broadheads, nocks and points.

LFT Liquid Ferrilitite .75

3848 Stick type..... .35

FC Fletch cement50



"AIR-FLO" FEATHERS



Most perfectly ground and sanded feathers on the market! Each feather is hand-graded for uniform size base and heavy fluff. Ends are trimmed off so that only the finest part of the feather remains.

Colors: Natural barred, Red barred, Orange barred, Yellow barred, Green barred, Blue barred, Clear white, Clear red, Clear orange, Clear yellow, Clear green, Clear blue, Solid black.

We list these in 3 dozen boxes but always put in plenty of extra feathers to insure perfect results.

130 - 24 natural - 12 dyed barred \$1.75

131 - 36 natural barred feathers..... 1.75

132 - 36 dyed barred feathers..... 2.00

133 - 36 natural white feathers..... 2.75

134 - 36 dyed white feathers..... 3.00

Specify left or right wing feathers when ordering.

EASTERN FLETCHING JIG

Self-indexing nock receiver enables you to do 3, 4 or 6 feather spiral or straight fletching - handles 1/4" to 3/8" shafts - any type nocks.



EFJ Eastern fletcher.....\$5.50

MICROMETER-BARRELED SHAFTS



Our Port Orford Cedar shafts are famous for their outstanding quality. Each shaft has the grain weight marked on it - and they are matched within five pounds in spine.

137 - 5/16" or 11/32".....\$3.25

UNMATCHED CEDAR SHAFTS

These are parallel mill run shafts - full length.

139 - 5/16" dia. \$.90 doz. \$ 7.00-100

140 - 11/32" dia. 1.50 doz. 12.00-100

PADDED BOW CASE



Waterproof finish with full length zipper along side - lined with thick felt padding - a deluxe case in every respect - comes in 3 lengths - 5'4" - 5'6" and 6 ft.

PBC - Give length desired.....\$6.50

ZC - Zipper Case..... 2.95

CLOTH BOW CASES



Made in colorful plaid patterns - with leather reinforcement at end - ties shut with draw string. Choice of 5'4" or 6 ft. lengths.

CBC - Give length desired.....\$1.75

Extra Wide Cloth Case..... 2.00

"AIR-FLO" DIE CUT FEATHERS



List Prices per dozen - in cellophane packages

Size	Gray		Dyed	
	Barred	White	Barred	White
2 1/2"	.40	.45	.50	.60 doz.
3"	.50	.55	.60	.70 doz.
3 1/2"	.55	.60	.70	.80 doz.
4"	.60	.65	.80	.90 doz.
4 1/2"	.65	.70	.85	1.00 doz.
5"	.70	.75	1.00	1.10 doz.
5 1/2"	.75	.80	1.05	1.15 doz.

HAMILTON PLASTIFLETCH



HAMILTON PLASTIFLETCH
P15 1 5/8" Small100 2.00
P22 2 1/4" Medium100 2.50
P25 2 3/4" Regular100 3.00
P26 2 3/4" Parabolic ...100 3.00
P32 3 1/4" Parabolic ...100 3.50
Choice of Red, Yellow or White Vanes.
FLOURESCENT PLASTIC
VANES\$1.00 C - Extra "

ARROW CLIPS

The perfect clip for tackle boxes, arrow display racks. Made of finest spring steel, nickel plate over copper and burnished.

AC-24 Pack of 24 clips and screws\$1.00

AC-144 Gross pack.... 6.00

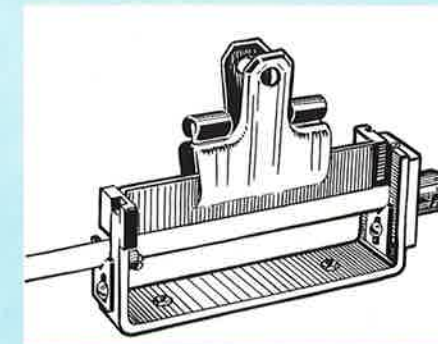

Universal HELICAL FLETCHER

Original, patented 60 degree spiral (in 5 inches) Helical fletcher does the work of 3 ordinary jigs without changing parts. Does Helical 4 fletch-Helical 3 fletch - Straight 4 fletch or Straight 3 fletch. The floating index knob guarantees perfect feather positioning in relation to the shaft axis - "V" shaped clamp grips the feather at the base for best results - 100% satisfaction guaranteed.

UHF - Helical fletching jig. \$15.00



COMPOSITE BOW STRINGS



The finest strings made. Made of special Type B Dacron - double loops - fully served at both ends and center - packed in re-usable plastic boxes. Specify bow weight and draw length - string length is length of the bow measured from nock to nock. This is usually marked on the side of the bow.

Your choice of the following sizes: 52, 54, 56, 57, 58, 60, 63, 64, 66, 67, 68, 69

DLBS Above strings, each **\$1.50**
2 for **2.95**

For perfect fit on American bows specify name, length and draw weight.

BOW STRING CHART

All lengths of double loop strings are made in 5 bow weights. Listed here are the number of strands used for various weights.

25 to 35# 8 strands 55 to 65# 14 strands
35 to 45# 10 strands 65 to 80# 16 strands
45 to 55# 12 strands

STRINGS FOR GLASS BOWS

Made of the same fine materials as the above, but have smaller loops for better fitting.

Your choice of the following sizes: 48, 50, 52, 54, 56, 58, 60, 66 lengths

GBS 2 for **\$2.95**

LINEN SINGLE LOOP STRINGS

For all bow weights and lengths. Center served and re-inforced at both ends for long life. Neatly coiled and packed with the bow length and bow weight marked on the package.



LS - 52/55 for 52" to 55" bows **\$1.40**
LS - 56/59 for 56" to 59" bows **1.40**
LS - 60/63 for 60" to 63" bows **1.40**
LS - 64/68 for 64" to 68" bows **1.40**
LS - 69/72 for 69" to 72" bows **1.40**

SPECIFY BOW WEIGHT WHEN ORDERING

SINGLE LOOP BOW STRINGS

Fit all bow lengths up to 60 inches not over 30 lbs.

HS - Each **.40**
Dozen **4.80**



DOUBLE LOOP BOW STRINGS

For any glass or wood bow up to 30 lbs. Made in four lengths - 48" - 50" - 52" - 54".

HDL Individually packaged, ea. **\$.60**
Dozen **7.20**

Trailing Tips

Pocket size edition of the famous Art Laha booklet gives bowhunting secrets. TT **\$.50**

Art Laha Knife

Bone handle - Solingen steel blade - 3 1/2" long. Includes leather case. HK **2.95**



Kwee Kwiver

Holds 4 hunting arrows in ready-to-shoot position. Slips on and off of any bow. Made of soft, pliable rubber riveted between metal.

KK-1 pair **3.50**
Box of 6 **21.00**



National Bow Quiver

Can be mounted or removed in seconds - with the bow strung or unstrung. Holds 4 arrows - made of 1/2" soft rubber matt.

NBQ pair **2.95**
Box of 6 **17.70**



String Silencers

Mount on bowstring to dampen string noise. They stop string vibration. Every bowhunter should use them. Takes only seconds to attach.

SS pair **.90**
12 pair on display **10.80**



New Items - Too Late to Catalog

Keen-Kill Broadhead Sharpener - glass hard cutting edges assure long life. **KKS** **\$1.49**

Camnu-Super Sharpener - The finest broadhead sharpener made at any price. **SBS** **4.95**

String Checker - Hamilton design - assures proper location of nocking point and fistmele measurement. Folds into easy-to-carry size. **SC** **3.00**

NFAA HANDBOOK

Contains all the rules and regulations of the National Field Archery Association. Every archer should have it.



NHB Latest edition **\$1.75**

MOHAWK GLOVE POWDER

Specially compounded powder gives a faster, smoother release when applied to any glove or tab. Prevents sweaty hands from interfering with bow grip.



GP Glove powder **\$.49**

BOW CARE

Cleans and polishes arrows, eliminates straw pick-up, waterproofs fletching, makes old bows look like new, makes new bows more glamorous! Spray-on aerosol can.



BC 5 oz. can **\$1.50**

STRING HOLDER



Fits on any bow - holds the bow string in place while the bow is transported or stored. Keeps the fistmele correct by preventing the string from untwisting. Made of leather and adjustable elastic strap with string hook.

SK String Keeper **\$.75**

JON-E HAND WARMERS

Famous Jon-e Standard Size Warmers give heat for 2 days on one filling. Easy-to-start - carrying bag included. **J-2 Standard** **\$3.95**
Deer-Coy Lure and Clip for use with any warmer. **J-3 Lure and Clip** **1.45**



WARMER FLUID

Jon-e warmers work best with this fuel - also works for cigarette lighters. **J-6** 8 oz. can **\$.45**

KAMO BRAND



CAMOUFLAGE PARKA

Coat length style with full zipper front. Made of 5 color camouflage marquisette netting. Water repellent treated. Full cut, slash pocket openings. Parka hood with drawstring and face cover for complete camouflage. Gives mosquito protection too. Sizes: Small, Medium, Large and Extra Large.

75 **\$5.95**

KAMO HEADNET

Can be worn over parka hood or cap. Fits any size. Easy to see out. Completely conceals face, eyes and neck. Perfect insect protection too.

35 **\$1.25**



KAMO STICK

Each stick contains two colors, tan and green. Easy to apply. Contains insect repellent. Camouflage your face, hands, bow or gun. Will not wash off in the rain - easily removed with soap and water.

25 **\$.50**



CAMOUFLAGE EQUIPMENT

KAMO BOW COVER

Easy on - easy off. Will not interfere with bow action. Individually packed in clear polyethylene bag. Two sizes: No. 1 for smaller bows, No. 2 for larger bows.

125 **\$1.50**

KAMO HAT

Jones style, water repellent camouflage hunting hat. Flannel lining - lined ear flaps. Ideal for bowhunting. Sizes: 6 7/8 to 7 5/8.

40 **\$1.50**



KAMO SUIT 2 PIECE

Heavy Zelan treated water repellent cotton poplin, permits noiseless movement. Very full cut - Jackets have 3 pockets. Trousers have adjustable waist tabs and 4 extra large pockets. This is the best camouflage pattern on the market.

85 SML **\$12.95**

85 XL **13.95**

85J - JACKET ONLY

SML **\$7.00**
XL **7.50**
XXL **8.00**

85P - PANTS ONLY

SML **\$6.00**
XL **6.50**
XXL **7.00**

P. S. **OLT** CO. PEKIN, ILL.

GAME AND BIRD CALLS



OLT'S REGULAR CROW CALL E-1

The "grand favorite" among the crow hunters. Lightweight—easy blowing. Tone raucous and far carrying. Black hard rubber.

Length 3 1/2"—Wt. 1/2 oz. **LIST PRICE...\$2.75**
(1/2 dozen in display box—Wt. 1 lb.)



OLT'S COON CALL N-27

Made to provide "low-cost" success to the sport of coon hunting. Produces a deep guttural sound which arouses the curiosity of a well-hidden coon. Hard rubber. Black barrel, gray tone bell.

Length 4 1/2"—Wt. 1 oz. **LIST PRICE...\$2.95**
(1/2 dozen in display box—Wt. 1 lb.)



OLT'S PREDATOR CALL T-20

Most effective predator call built for year-round use. Makes "distress cry" of small animal. Irresistible to fox, coyote, wolves, bobcats and other predators. Hard rubber. Black barrel, green tone bell.

Length 4 1/2"—Wt. 1 oz. **LIST PRICE...\$2.95**
(1/2 dozen in display box—Wt. 1 1/2 lb.)



OLT'S PERFECT SQUIRREL CALL S-8

Famous for its "perfect tone" which squirrels can't resist. Hand operated—so easy to use. No metallic or muffled wood sounds to mar "true-life" tone. Hard rubber. Brown barrel, black plug and plunger.

Length 5 1/4"—Wt. 2 1/2 oz. **LIST PRICE...\$3.95**
(1/2 dozen in display box—1 1/2 lb.)

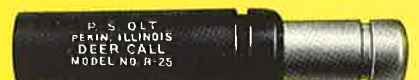

OLT'S DEER CALL R-25

A reed-type call, built for perfection—not for price. A positive aid to halt moving deer and get a standing shot or to bring deer to you and into the open. Hard rubber, Black barrel, red tone bell.

Length 4 1/2"—Wt. 1 oz. **LIST PRICE...\$3.95**
(1/2 dozen in display box—Wt. 1 lb.)



Moose trophy taken by Rick Cooley in Alaska in September 1962 under the expert guidance of Art Laha. This moose will go high in the Pope and Young club and was taken with a 48# bow.