

LIVE YOUR ON-THE-WATER

dreams



HARRIS®

2022



HARRIS[®]

With over 120 dealers in North America, there's always a knowledgeable Harris team nearby and ready to help. Contact your local dealer to learn more about Harris.

LEARN MORE ABOUT HARRIS AT HARRISBOATS.COM



Your family is our north star. Our passion lies in giving you the lake experience you love, whether that's midday cannonballs from your Cruiser or sunset soirées on your Crowne.

For over 60 years, we've delivered performance, comfort, and power. We promise to keep innovating for your family beyond the next 60.

All information contained in this brochure is believed to be correct as of printing. Not all accessories shown in pictures described are standard equipment or available as options. Options and features are subject to change without notice. Not all model year boats may contain all the features or meet the specifications described in the brochure. All weight specifications are approximate. Bimini lengths may vary slightly due to stretching and mounting. Confirm availability of all accessories and equipment with your authorized dealer prior to purchase.

10 CROWNE



14 GRAND MARINER



20 SOLSTICE



24 SUNLINER



28 CRUISER



32 CRUISER LX







WE GROW *as you grow*

You inherited the FloteBote your granddad spent years on, cruising with his friends as stories and drinks flowed under the summer sun.

When you grew up, you bought a Solstice, proposed on the bow, and floated through your first years as a married couple.

And this year, you're searching for a pontoon for the next generation. One with the power to give your daughter her first wakeboard ride. With the tech to keep your son and his friends on the water longer with fully charged phones.

You choose Harris because we grow with you.

[LEARN ABOUT OUR JOURNEY AT HARRISBOATS.COM](https://www.harrisboats.com)

THE ALL-NEW GRAND MARINER

We dreamt big as we designed the 2022 Grand Mariner, and it shows in every detail.

TECH

The fully digital dashboard is loaded with custom user interface and control design in close collaboration with C-Zone.® Control the powered tower, lighting, and sound system using your remote key fob, and charge your devices throughout the boat with more USB ports. (C-Zone also available on Solstice)

AUDIO

Give your cruise the ultimate sound track with JL Audio.

LIGHTING

Illuminate the night with a stunning, colorful light display you can control through your C-Zone panel.

OUR EVOLUTION

YOU NEVER STOP CHANGING AND GROWING—WHICH MEANS NEITHER DO WE.

When it comes to innovating for your future, we never stop advancing. We navigate toward the horizon in the pursuit of advanced technology, greater power, and exceptional amenities to continue delivering the luxurious pontoons you deserve.



FULL-LENGTH GATE STOPS

Full-length gate stops are tested for up to 400 pounds of static load, enhancing safety by supporting the weight of occupants and bolstering the overall integrity of the fencing.

PROTECTIVE HEAVY-DUTY RUBRAIL

A patented 3" deep heavy-duty rubrail along the deck's perimeter is supported by thick crossmembers rather than the deck for added impact resistance.

FOUR-STEP WATER PREVENTION SYSTEM

Water-intrusion is minimized with rubber tape between crossmembers, sealant between deck seams, and interlocking tongue-and-groove decking on some models, with additional urethane sealant along top seams and on screw caps.

TOTAL TORSION REDUCTION SYSTEM

Continuous M-brackets diminish torque and twist, ensuring a sturdy and stable ride. Unlike most competitors, Harris brackets run the full length of the tube.

INNOVATIVE CROSSMEMBER INFRASTRUCTURE

Strategic crossmember placement, spanning the entire deck width in the boat's foundation, adds strength where the most stress occurs while reducing overall weight.

TWO-PIECE DOLPHIN NOSE CONE

Since 1959, the dolphin nose cone slices water with minimal spray. Two-piece design ensures durability and confident handling with no exposed welds.



LEAVE YOUR WORRIES *in your wake*

We believe your enjoyment on the water is our responsibility, which is why we offer our 10-year bow-to-stern and limited lifetime structural warranties.*

Harris associates take pride in providing the best solutions the first time, so you can spend more days on the water creating memories. In concert with an extensive network of over 120 dealers in North America, Harris brings you the finest pontoons and service in the industry.

*See Express Limited Warranty for complete details. Limitations and exclusions apply.



10 YEAR BOW-TO-STERN WARRANTY
Harris provides warranty coverage for ten years, including materials and workmanship. The engine is covered by the engine manufacturer's warranty.*



LIMITED LIFETIME STRUCTURAL WARRANTY
Our warranty covers the pontoon tubes, crossmembers, decking, motor mount, fence rail, and other structural components.*

PERFORMANCE PACKAGES

Our performance packages let you customize your boat for however your family likes to spend time.



LEVEL 1

For families who spend their time cruising or fishing, this package is the most economical, easiest way to get on the water.

- Two 25" diameter outer tubes
- Partial 25" diameter center tube
- 28-gal. fuel capacity
- Half skin kit

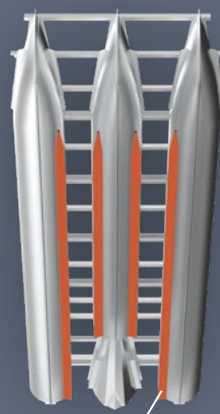

LIFTING STRAKES



LEVEL 2

Our most popular package offers more seating space, control, and power for families who can't get enough water sports.

- Three 25" diameter tubes
- 37-gal. fuel capacity
- Integrated motor pod
- Ski tow bar
- Skin kit to front crossmember
- In-floor storage included on Solstice, Grand Mariner, and Crowne; optional on Sunliner and Cruiser

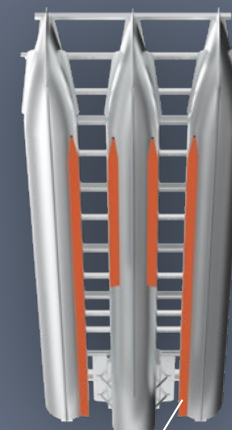

LIFTING STRAKES

PERFORMANCE FEATURES

✓ **ALUMINUM UNDERSKIN**
reduces drag and splash for a quiet, smooth ride.

✓ **UNIQUELY PLACED STRAKES**
get you onto plane more quickly for better performance.

✓ **DROPPED CENTER TUBE**
on triple-toons creates a v-hull shape for easier turning and control.

✓ **ANTI-CORROSION SALTWATER ANODES** available with any performance package.



LEVEL 3

This package offers more stability and a larger tank—with a slight compromise on guest capacity—for families whose travels require more power for bigger waters.

- Three 25" diameter tubes
- 63-gal. fuel capacity
- Skin kit to front crossmember
- Ski tow bar or pylon
- In-floor storage
- Available on Solstice, Grand Mariner, and Crowne

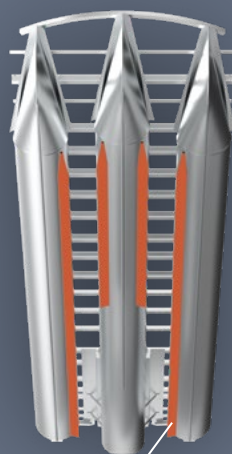

LIFTING STRAKES



LEVEL 3.5

Built for adventurous families who brave large, rougher bodies of water, this package offers wider tubes for more buoyancy.

- Three 27" diameter tubes
- 63-gal. fuel capacity
- Skin kit to front crossmember
- Ski tow bar or pylon
- In-floor storage included on Solstice, Grand Mariner, and Crowne; optional on Sunliner and Cruiser

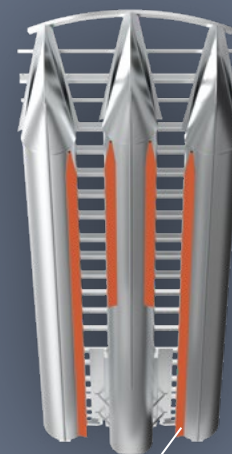

LIFTING STRAKES

CROWNE

ABSOLUTE LUXURY FROM BOW TO STERN



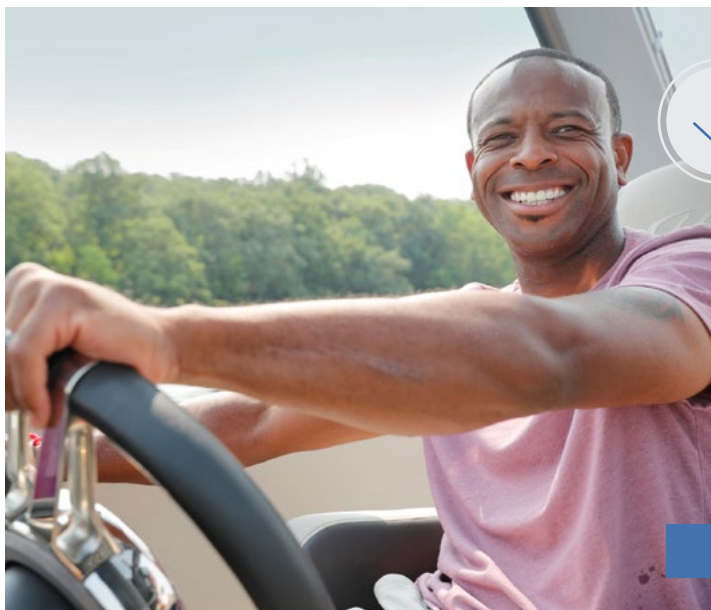

A DAY *Together*

Your guests have been waiting for this outing, waiting to indulge in the sleek sophistication and generous entertainment amenities of your Crowne.

You can feel the Crowne's power below your fingertips as it cuts effortlessly through the water. Cool, comfortable seating allows your friends and family to relax and enjoy a day of socializing.

With its glass dash display and adjustable seat, the helm makes the captain feel like royalty.

CROWNE



AT HARRISBOATS.COM



We couldn't be any happier with the quality and performance of the Harris Crowne. The new articulating top and rear lounge area are highlights of the boat.

—Warren B.

CROWNE SL 250
METALLIC GRAY

	DL/SL 250 Single Outboard	DL/SL 270 Single Outboard	DL/SL 250 TE Twin Outboards	DL/SL 270 TE Twin Outboards
Overall Length	27'11"	29'9"	26'9"	28'10"
Pontoon Length	25'	28'	26'	28'
Tube Diameter	25"	27"	27"	27"
Beam Width	8'6"	8'6"	8'6"	8'6"
Weight - lbs*	4,161	4,793	4,665	5,111
Person Capacity**	11-14	15-16	8-11	10-13
Max Weight Capacity - lbs*	2,435	3,067	2,993	3,235
Fuel Capacity (PL2 / PL3) - gal	37 / 63	- / 63	93	93
Max HP	450	450	Twin 350	Twin 450

* Weights represent approximate dry weight of boat including options excluding engine. Weight capacities represent standard option for each model.

** Person capacity ratings represent approximate number of people. Rating will vary by configuration and selected options. Refer to installed capacity plate for exact rating.



CROWNE SL 270 TE
FRENCH GRAY

TWIN ENGINE PERFORMANCE PACKAGE

Available exclusively on Crowne, this package is the ultimate way for your family to get the most out of your pontoon.

- Three 27" diameter tubes
- 93-gal. fuel capacity
- Up to 900 hp with twin 450R option, and 60 mph
- Optional joystick piloting with GPS anchoring
- Waypoint auto-heading

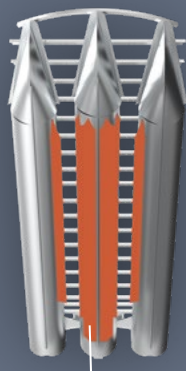

LIFTING STRAKES

- 1 BOW LOUNGER shown in French Gray upholstery
- 2 SINGLE REAR LOUNGER (SL) shown in French Gray upholstery
- 3 ADJUSTABLE CAPTAIN'S CHAIR AND HELM with Simrad® displays

GRAND MARINER

POWER BY DAY. PLAY BY NIGHT.





GET MORE FROM *every day*

Summer days feel longer when you board your Grand Mariner in the morning and don't return to the dock until well after dusk.

The kids cling to their seats, laughing as you show off the Grand Mariner's power, its newly styled sloped front cutting through the wind.

When the sun sets, it's time to use your key fob or the intuitive C-Zone user interface on the dash to fire up a stunning lightshow.

Every outing aboard the Grand Mariner brings a full-spectrum lightshow—and it's all under your control with C-Zone.

GRAND MARINER



AT HARRISBOATS.COM



This Grand Mariner evokes emotion and passion from the styling to the beautiful lighting to the class-leading technology.

–Chris Bernauer,
President, Harris Boats

GRAND MARINER 270
WHITE DIAMOND WITH MATTE BLACK ACCENT | ION TOWER

	230	250	270
Overall Length	26'2"	27'11"	29'9"
Pontoon Length	23'	25'	27'
Tube Diameter	25"	25"	25"
Beam Width	8'6"	8'6"	8'6"
Weight (2 tubes) - lbs*	3,166	3,306	-
Weight (3 tubes) - lbs*	3,926	4,150	4,431
Person Capacity (2 tubes)**	9-11	11-13	-
Person Capacity (3 tubes)**	11-13	11-15	13-15
Max Weight Capacity (2 tubes) - lbs*	1,973	2,189	-
Max Weight Capacity (3 tubes) - lbs*	2,625	2,558	2,885
Fuel Capacity (2 tubes) - gal	28	28	-
Fuel Capacity (PL2 / PL3) - gal	37 / 63	37 / 63	37 / 63
Max HP (2 tubes)	200	200	-
Max HP (3 tubes)	300	450	450

*Weights represent approximate dry weight of boat including options excluding engine. Weights and weight capacities represent 25" diameter tube configurations.

**Person capacity ratings represent approximate number of people. Rating will vary by configuration and selected options. Refer to installed capacity plate for exact rating.



GRAND MARINER 250 SL
MOONLIGHT GRAY

- 1 BOW SEATING shown in Moonlight Gray pillowtop upholstery
- 2 MULTI-POSITION REAR LOUNGER shown in French Gray upholstery
- 3 STANDARD ULTRALUX HELM CHAIR shown in French Gray upholstery

GRAND MARINER

DESIGNED BY YOU



2

1

3



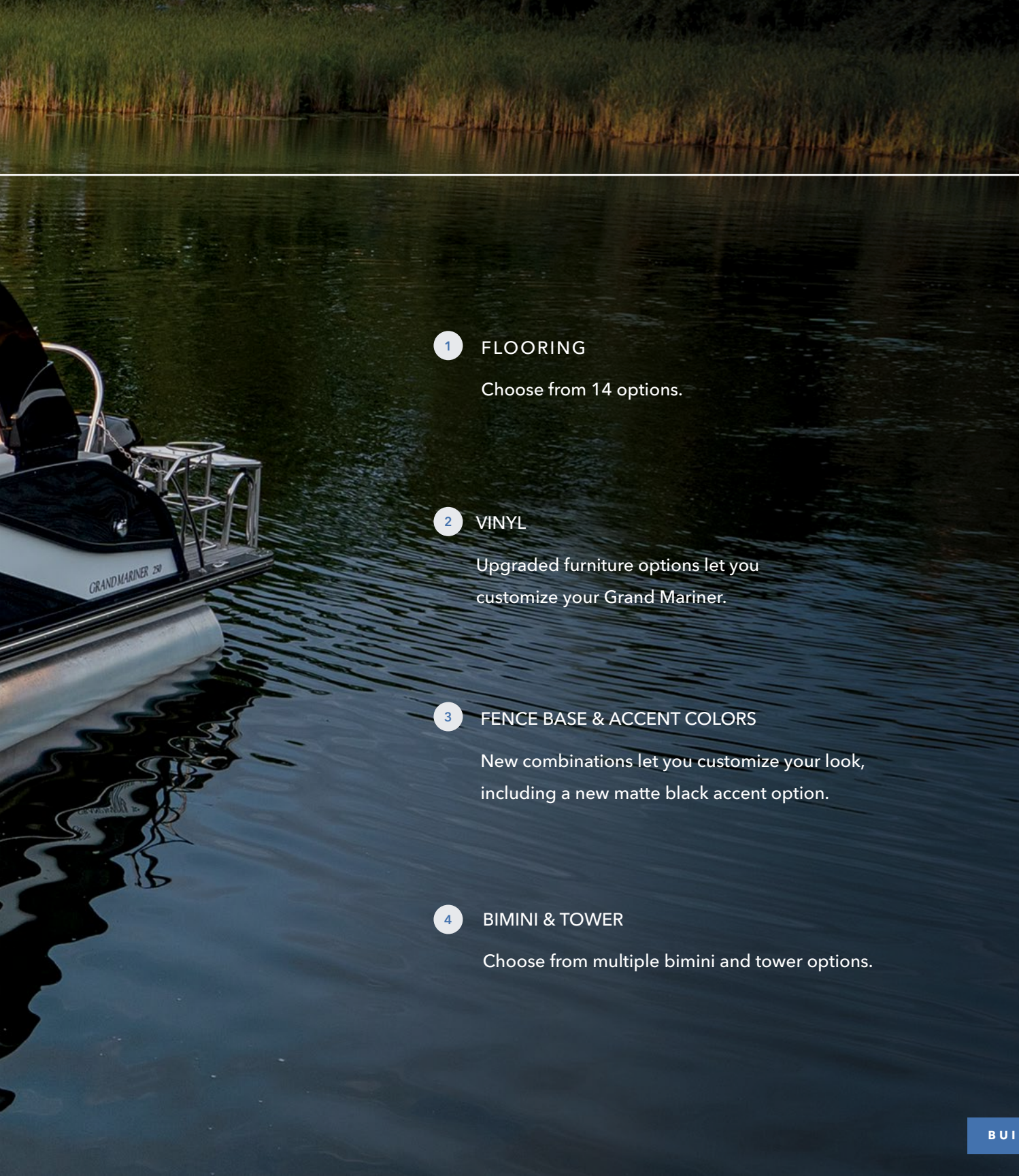

4

With a full spectrum of colored lighting, you can change the look of your Grand Mariner with a few taps on your dash or key fob.



- 1 FLOORING**
Choose from 14 options.
- 2 VINYL**
Upgraded furniture options let you customize your Grand Mariner.
- 3 FENCE BASE & ACCENT COLORS**
New combinations let you customize your look, including a new matte black accent option.
- 4 BIMINI & TOWER**
Choose from multiple bimini and tower options.

PILLOWTOP VINYL OPTIONS

	Furniture base vinyl color	Accents
	MOONLIGHT GRAY	CARBON ONYX LIGHT BLUE MIDNIGHT BLUE CRIMSON
	FRENCH GRAY	CARBON ONYX LIGHT BLUE MIDNIGHT BLUE
	DESERT CAMEL	CARBON KODIAK ONYX WHITE
	CHESTNUT BROWN	CARBON ONYX WHITE

For more options, view page 36 or visit the Design Center at harrisboats.com/design-center.html

SOLSTICE

SPORTY, SMART, AND ALWAYS SMOOTH





AN AFTERNOON *of energy*

Feel the excited energy emanating from your family as your Solstice powers forward effortlessly, the smooth ride creating an easy first run for a beginner waterskier.

Solstice's sporty colors, smooth styling, and JL Audio® speakers available on the optional Ion tower turn heads while your guests laugh throughout a day of fun.

Solstice's ride-enhancing performance packages with horsepower ratings up to 400 bring even more adrenaline to water sports.

SOLSTICE



AT HARRISBOATS.COM



This pontoon is a perfect combination of comfort and functionality, providing hours of enjoyment for the whole family and friends. The quality of the interior has brought a multitude of compliments from our friends.

—Duane H.

SOLSTICE 230
BLACK SAPPHIRE

	230	250	DC 250	RD 260 Rec Deck
Overall Length	26'2"	27'11"	27'11"	30'1"
Pontoon Length	23'	25'	25'	25'9"
Tube Diameter	25"	25"	25"	27"
Beam Width	8'6"	8'6"	8'6"	8'6"
Weight (2 tubes) - lbs*	2,728	2,903	-	-
Weight (3 tubes) - lbs*	3,266	3,686	3,611	4,882
Person Capacity (2 tubes)**	10-12	12-13	-	-
Person Capacity (3 tubes)**	12-14	11-15	12-15	15
Max Weight Capacity (2 tubes) - lbs*	2,219	2,427	-	-
Max Weight Capacity (3 tubes) - lbs*	2,430	2,576	2,597	2,838
Fuel Capacity (2 tubes) - gal	28	28	-	-
Fuel Capacity (PL2 / PL3) - gal	37 / 63	37 / 63	37 / 63	- / 63
Max HP (2 tubes)	200	200	-	-
Max HP (3 tubes)	300	400	400	300

* Weights represent approximate dry weight of boat including options excluding engine. Weights and weight capacities represent 25" diameter tube configurations.

** Person capacity ratings represent approximate number of people. Rating will vary by configuration and selected options. Refer to installed capacity plate for exact rating.



SOLSTICE
230 CW
FRENCH GRAY

SOLSTICE
250 EDGH
DESERT CAMEL

- 1 BOW SEATING shown in Chestnut upholstery
- 2 ENTERTAINMENT GALLEY WITH DUAL HELM SEATS shown in Desert Camel upholstery
- 3 HELM shown with Simrad GO7 display in French Gray

SUNLINER

CREATING YOUR FAMILY FUN DAY—**EVERY DAY**





BRING EVERYONE *together*

Weekends, holiday weekends, or school nights—whenever your family has free time together, you're on your Sunliner.

Your teens like the charge-from-anywhere convenience. Your youngest splashes in the water at every opportunity. And you all love being seen cruising on this sleek pontoon.

The multiposition lounge lets the whole crew hang out to talk, sunbathe, or prep for watersports.

SUNLINER



AT HARRISBOATS.COM



“

We've only owned our pontoon for four weeks, and we've already recorded over 30 engine hours. We just LOVE this vessel. **Just a classy, comfortable, beautiful, and easy-to-maneuver boat that we are going to enjoy for generations.**

—Aaron M.

SUNLINER 250
WHITE DIAMOND

	210	230	230 sport	250	250 sport
Overall Length	22'1"	23'5"	23'5"	25'10"	25'10"
Pontoon Length	20'6"	22'	22'	24'	24'
Tube Diameter	25"	25"	25"	25"	25"
Beam Width	8'6"	8'6"	8'6"	8'6"	8'6"
Weight (2 tubes) - lbs*	2,144	2,496	-	2,702	-
Weight (3 tubes) - lbs*	2,425	2,812	3,098	3,088	3,374
Person Capacity (2 tubes)**	9-12	10-13	-	12-15	-
Person Capacity (3 tubes)**	10-12	11-14	11-12	14-16	14-16
Max Weight Capacity (2 tubes) - lbs*	1,964	2,072	-	2,315	-
Max Weight Capacity (3 tubes) - lbs*	2,120	2,306	2,372	2,658	2,685
Fuel Capacity (2 tubes) - gal	28	28	-	28	-
Fuel Capacity (PL2 / PL3) - gal	37 / 63	37 / 63	37 / 63	37 / 63	37 / 63
Max HP (2 tubes)	200	200	-	200	-
Max HP (3 tubes)	200	300	300	300	300

* Weights represent approximate dry weight of boat including options excluding engine. Weights and weight capacities represent 25" diameter tube configurations.

** Person capacity ratings represent approximate number of people. Rating will vary by configuration and selected options. Refer to installed capacity plate for exact rating.



SUNLINER
230 CWEC
BEACH TAN



SUNLINER 250
SPORT
MOONLIGHT GRAY

- 1 BOW SEATING shown in French Gray pillowtop upholstery
- 2 MULTI-POSITION REAR LOUNGER shown in Moonlight Gray upholstery
- 3 HELM with standard gauges and JL stereo upgrade shown in Beach Tan



WHEELCHAIR-FRIENDLY GATE

The Sunliner model features an extra-wide 34" port side gate on 250 models, making the boat more accessible.

CRUISER

ALL THE COMFORT AND PERFORMANCE—AT A VALUE





WHAT WILL YOU *choose?*

The day's options are limitless on your Cruiser. Will you listen to the game or cast a line? Adventure solo or invite the whole gang?

Whatever the day holds, the value-packed Cruiser delivers with easy comfort and style.

With a livewell and rod holders, the fish station makes reeling in a catch easier.

CRUISER



AT HARRISBOATS.COM



Just a quick shout out to Harris Pontoons for another great boat! We have the '21 Cruiser with dual helm seats, upgraded motor, and stereo! **Comfort and quality all rolled into one!**

—Thomas R.

CRUISER 230
STERLING GRAY

	190	210	230	250
Overall Length	20'1"	22'1"	23'5"	25'10"
Pontoon Length	18'6"	20'6"	22'	24'
Tube Diameter	25"	25"	25"	25"
Beam Width	8'6"	8'6"	8'6"	8'6"
Weight (2 tubes) - lbs*	1,936	2,144	2,496	2,702
Weight (3 tubes) - lbs*	-	2,425	2,812	3,088
Person Capacity (2 tubes)**	8	9-12	10-13	12-15
Person Capacity (3 tubes)**	9	10-12	11-14	14-16
Max Weight Capacity (2 tubes) - lbs*	1,667	1,964	2,072	2,315
Max Weight Capacity (3 tubes) - lbs*	1,711	2,120	2,306	2,658
Fuel Capacity (2 tubes) - gal	28	28	28	28
Fuel Capacity (PL2 / PL3) - gal	-	37 / 63	37 / 63	37 / 63
Max HP (2 tubes)	75	200	200	200
Max HP (3 tubes)	90	200	300	300

*Weights represent approximate dry weight of boat including options excluding engine. Weights and weight capacities represent 25" diameter tube configurations.

**Person capacity ratings represent approximate number of people. Rating will vary by configuration and selected options. Refer to installed capacity plate for exact rating.



CRUISER 230 CWEC
BEACH TAN

CRUISER 190 SL
MOONLIGHT GRAY

- 1 BOW SEATING shown in Moonlight Gray upholstery
- 2 AFT CS SEATING shown in French Gray upholstery
- 3 STANDARD HELM shown in French Gray upholstery with 5" gauges



WHEELCHAIR-FRIENDLY GATE

The Cruiser features an extra-wide 34" port side gate on 250 models, making the boat more accessible.

CRUISER LX

OUR PLUSH, MODERN TAKE ON A CLASSIC





BUILT FOR *socializing*

Today's guest list includes the sun goddess, the cruising queen, and the angler extraordinaire. Your Cruiser LX has space for all of them.

Classic pontoon styling meets powerful performance, plush comforts, and modern amenities—all at a value you'll love.



Spacious floor plans give you all the room you need for the activity of the day.

CRUISER LX



From the time we ordered our Harris through the on-the-water orientation, everything was seamless. **So far, this is the best boat we have ever owned, and this is our fifth!**

–Charles N.



CRUISER LX 200
MIDNIGHT BLUE

	160	180	200
Overall Length	17'10"	19'6"	21'4"
Pontoon Length	16'3"	18'3"	20'3"
Tube Diameter	25"	25"	25"
Beam Width	8'	8'	8'
Weight - lbs*	1,629	1,673	1,780
Person Capacity**	8	9	11
Max Weight Capacity - lbs*	1,640	1,938	2,214
Fuel Capacity - gal	6	6	6
Max HP	50	75	90

* Weights represent approximate dry weight of boat including options excluding engine.

** Person capacity ratings represent approximate number of people. Rating will vary by configuration and selected options. Refer to installed capacity plate for exact rating.



CRUISER LX 200
CRUISE
GRAY



CRUISER LX 160
FISH
TAN

-
- 1 BOW SEATING fish floorplan shown in Tan upholstery
 - 2 STARBOARD BOW LOUNGER shown in Gray upholstery
 - 2 AFT L GROUP SEATING shown in Gray upholstery
 - 3 STANDARD HELM shown in Tan with Lowrance® Hook2-4x

DESIGN CENTER

We're here to help you find the best pontoon, floorplan, trim level, and style for your family. Visit the Design Center to view all the available options.

[HARRISBOATS.COM/DESIGN-CENTER.HTML](https://harrisboats.com/design-center.html)



COLOR & VINYL OPTIONS

FENCE PANEL



BLACK SAPPHIRE



MIDNIGHT BLUE



CHAMPAGNE



FUSION RED



EBONY METALLIC



STERLING GRAY

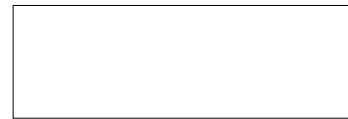

WHITE DIAMOND

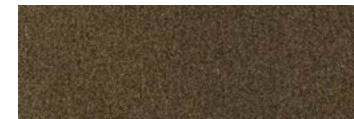

MOCHA PEARL



METALLIC GRAY

Additional matte finishes available in gray, black and blue

FENCE PANEL ACCENT COLORS



BLACK SAPPHIRE



MIDNIGHT BLUE



SPARKLING CHAMPAGNE



PLATINUM SILVER



DEEP RED METALLIC



LIGHT BLUE METALLIC



WHITE DIAMOND



MATTE BLACK

Discover our selection of vinyl fabrics in the Harris New Color Style Guide, available in the Design Center.

VINYL COLOR PALETTE OPTIONS



DESERT CAMEL



IVORY CASHMERE



FRENCH GRAY



CHESTNUT



BEACH TAN



SILVER GRAY

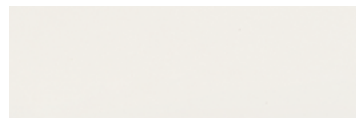

MOONLIGHT GRAY

FLOORING OPTIONS



SAND VINYL



DESERT BEIGE SEAGRASS



BEACHWALK SEAGRASS



OAKWOOD WOVEN TEAK



DARK WOVEN TEAK



GRAYWOOD WOVEN TEAK



GRAY VINYL



GRAY SEAGRASS



SLATE GRAY WOVEN TEAK



GRAY WOVEN TEAK

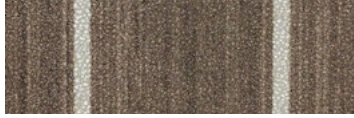

DRIFTWOOD TEAK VINYL



STERLING GRAY WOVEN VINYL



STONE GRAY SEA GRASS

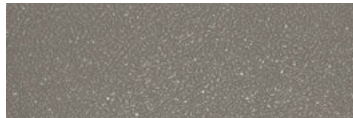

COOL GRAY VINYL

BIMINI CANVAS

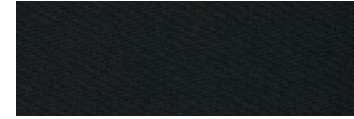

BLACK SAPPHIRE CANVAS



MIDNIGHT BLUE CANVAS

SPORT GRAPHICS

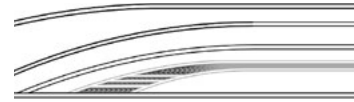

SILVER SPORT GRAPHIC
AVAILABLE WITH CRUISER SERIES



SILVER SPORT GRAPHIC
AVAILABLE WITH SUNLINER SERIES

TABLE ACCENTS



ESCALADE TEAK



TEAK

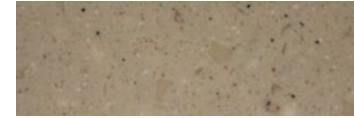

GULF COAST



PEBBLE GRAY



GRAY BURL

FEATURES & OPTIONS

SEATING



BASIC HELM SEAT
(SHOWN IN FRENCH GRAY)



HIGH BACK HELM SEAT
(SHOWN IN PILLOWTOP BEACH TAN)



ULTRALUX HELM SEAT
(SHOWN IN PILLOWTOP CHESTNUT VINYL)



MULTI-POSITION REAR LOUNGER
(STANDARD ON SOLSTICE SL FLOORPLANS)



JUMPSEAT
(AVAILABLE ON CRUISER, SUNLINER, SOLSTICE AND GRAND MARINER)

COOLERS



COOLER BAG
(AVAILABLE AS PART OF A CONVENIENCE PACKAGE)

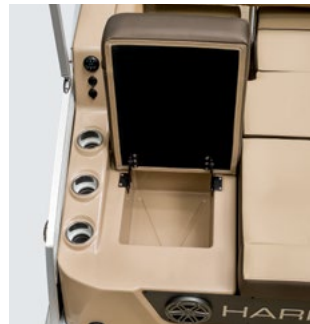

INTEGRATED COOLER
(STANDARD ON SOLSTICE SL, CRUISER SL AND CS, AND SUNLINER SL)



PORTABLE OTTOMAN WITH BUILT-IN COOLER

TABLES

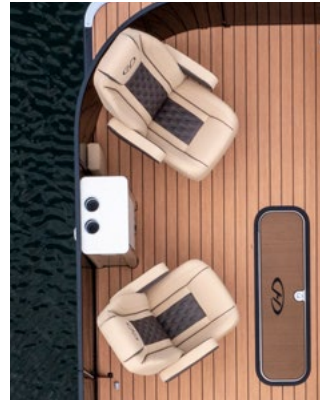

2-PIECE PORT BOW SEATING
(AVAILABLE ON SELECT CRUISER AND SUNLINER FLOORPLANS. SEE PAGE 50.)

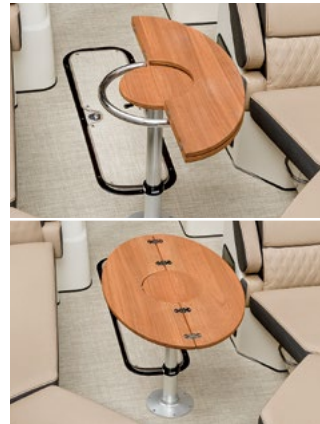

ARTICULATING TEAK TABLE
(AVAILABLE ON CROWNE SINGLE ENGINE MODELS)



TABLE WITH CUPHOLDERS
(STANDARD ON CRUISER MODELS)



WOODGRAIN LUXURY SPORT TABLE
(INCLUDED WITH TAN INTERIOR UPHOLSTERY. GRAY TABLE INCLUDED WITH GRAY INTERIOR UPHOLSTERY.)



CHAISE END TABLE
(AVAILABLE ON CRUISER, SUNLINER, SOLSTICE AND GRAND MARINER MODELS)



UPGRADED BLACK ACRYLIC TABLE WITH CUPHOLDERS AND STEMWARE HOLDERS

ELECTRONICS



SIMRAD GO7 AND GO9 GPS WITH SONAR
(AVAILABLE ON CRUISER, SUNLINER, SOLSTICE, GRAND MARINER AND CROWNE MODELS)



SIMRAD GO7 AND GO9 GPS WITH SONAR
(AVAILABLE ON CRUISER, SUNLINER, SOLSTICE, GRAND MARINER AND CROWNE MODELS)



GAUGES WITH LOWRANCE HOOK2-4X
(SHOWN ON SUNLINER)



C-ZONE USER INTERFACE STANDARD ON GRAND MARINER

LIGHTING



LIGHTED CUPHOLDERS AND SEAT-BASE ROPE LIGHTING



IN-FENCE DOCKING LIGHTS



RGB UNDERWATER LIGHTS



LIGHTED SPEAKERS



HEAVY-DUTY STAINLESS LED DOCKING LIGHT PODS



UNDERDECK LIGHTING

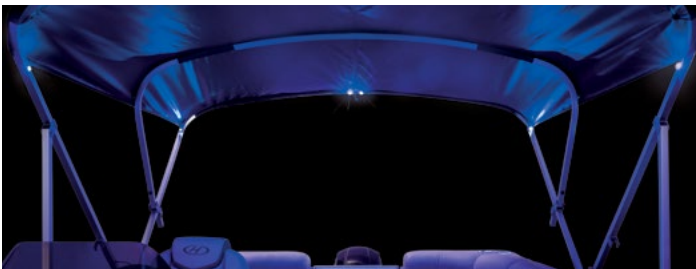

12' LIGHTED BIMINI

RGB LED LIGHTING

The full color spectrum is now at your fingertips with the new RGB LED lighting system. With the touch of a button, cupholders, seat bases, underdeck and underwater lighting are instantly illuminated with every color in the visible spectrum. Choose to operate the colors simultaneously or independently with the user-friendly, multi-zone controller which allows for endless customization of color selection, cycling, dimming and speed of color fade.

Vessel photographed in a controlled environment. Check local and state laws regarding the display of auxiliary lights and colors.



EXTERIOR LIGHTING

FEATURES & OPTIONS

HELM



EURO STEERING WHEEL
(STANDARD ON CROWNE, UPGRADE ON GRAND MARINER AND SOLSTICE)



TOURING STEERING WHEEL
(STANDARD ON SOLSTICE, UPGRADE ON CRUISER AND SUNLINER)



RAISED HELM
(STANDARD ON GRAND MARINER, OPTIONAL ON SUNLINER AND SOLSTICE)



HELM REARVIEW MIRROR

ENTERTAINMENT CENTERS



ENTERTAINMENT CENTER
(SOLSTICE AND GRAND MARINER SLEC FLOORPLAN) (REFRIGERATOR AVAILABLE AS UPGRADE)



ENTERTAINMENT BAR
(OPTIONAL REFRIGERATOR SHOWN)



ENTERTAINMENT CENTER
(AVAILABLE ON CRUISER CWEC AND SOLSTICE EGDH FLOORPLANS)



CENTER WALKTHROUGH WITH UNIVERSAL BAR
ON PORTSIDE (AVAILABLE ON SUNLINER 230)



ENTERTAINMENT BAR WITH WINE STORAGE
(SHOWN WITH STANDARD TOP; TEAK TOP AVAILABLE AS AN UPGRADE ON CROWNE)

SOUND AND STEREO



CLARION® BLUETOOTH® STEREO
(STANDARD ON CRUISER AND SUNLINER)



CLARION SPEAKER
(STANDARD ON CRUISER AND SUNLINER)



JL AUDIO MM50 HEAD UNIT
(STANDARD ON SOLSTICE, GRAND MARINER, AND CROWNE. UPGRADE ON CRUISER AND SUNLINER.)



JL AUDIO M3 SPEAKER



AUDIO MM105 HEAD UNIT
(INCLUDED WITH JL DIAMOND AND PLATINUM UPGRADES ON SOLSTICE, GRAND MARINER, AND CROWNE)



JL AUDIO SUBWOOFER



JL AUDIO TOWER CAN SPEAKERS
(AVAILABLE ON SOLSTICE, GRAND MARINER AND CROWNE)

SWIMMING AND WATERSPORTS



SKI TOW BAR
(NOT AVAILABLE ON TWIN ENGINE MODELS)



SKI TOW PYLON
(NOT AVAILABLE ON TWIN ENGINE MODELS)



SWIM SEAT
(AVAILABLE ON SOLSTICE, GRAND MARINER AND CROWNE)

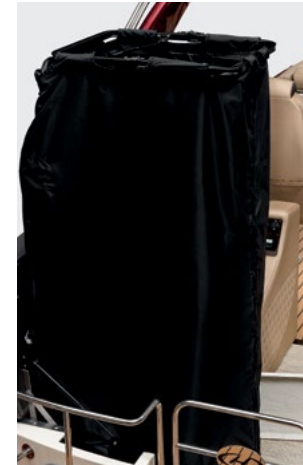

CROWNE CHANGING ROOM



CHANGING ROOM



EXTENDED REAR SWIM DECK
(STANDARD ON SUNLINER. AVAILABLE ON CRUISER.)

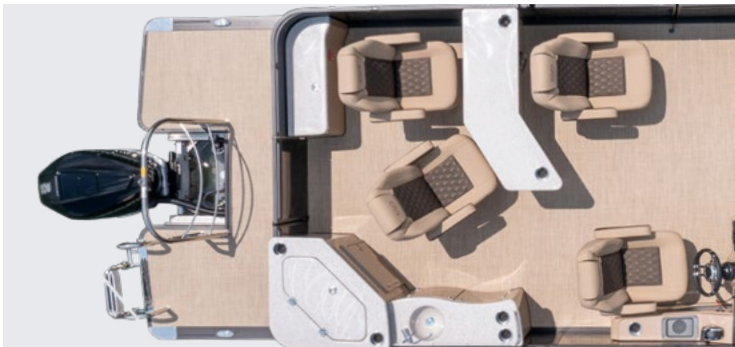

EXTENDED REAR PLATFORM
(ADDITIONAL REAR DECK SPACE ON 3-TUBE SOLSTICE, GRAND MARINER AND CROWNE)



4-STEP LADDER WITH PLATFORM



STAINLESS STEEL 4-STEP SST FOLD-DOWN
TELESCOPE LADDER

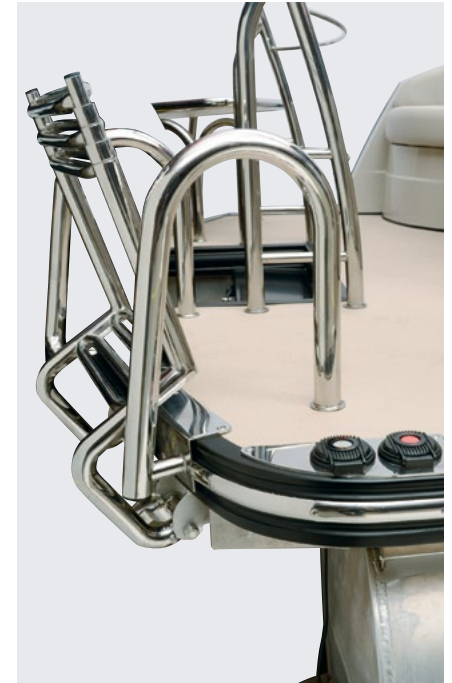

POWER DEPLOYING AND RETRACTING LADDER
(AVAILABLE ON SOLSTICE, GRAND MARINER AND CROWNE)

FEATURES & OPTIONS

FISHING



CORNER TACKLE STATION
(ON CRUISER LX FISH MODELS)



LIVEWELL IN PORTSIDE BOW
(ON CRUISER LX FISH MODELS)



FISH SEAT
(STANDARD ON CRUISER FC MODELS)

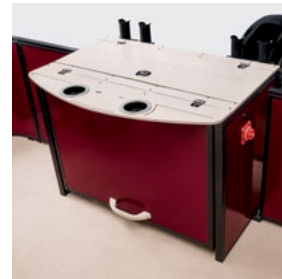

FISH STATION WITH LIVEWELL
AND ROD HOLDERS



CRUISER LX FISH FEATURES



HALF GATE FOR TROLLING MOTOR



IN-FLOOR ROD STORAGE ON CRUISER



ROD HOLDERS

DOCKING / STORAGE / COVERS



QUICK RELEASE FENDER SYSTEM
(MID-SHIP QUICK RELEASE AVAILABLE ON SOLSTICE,
GRAND MARINER AND CROWNE)



IN-FLOOR STORAGE AVAILABLE WITH PERFORMANCE
PACKAGE LEVEL 2, 3, 3.5 & TE



STAINLESS STEEL FLIP-UP CLEAT
(STANDARD ON GRAND MARINER
AND CROWNE)



STANDARD STAINLESS STEEL CLEAT



EZ-CLIP MOORING COVER
(MOORING COVER STYLES VARY BY MODEL; CONTACT DEALER FOR DETAILS)



SEAT COVERS SHOWN IN BLACK

Visit the Design Center at
harrisboats.com/design-center.html
 to explore our trim level packages.

BIMINI AND TOPS



10' BIMINI TOP



10' ELECTRIC BIMINI



12' BIMINI TOP



DOUBLE BIMINI



DOUBLE BIMINI OPEN



ULTRA TOWER



EVO TOWER



CROWNE SPORT ARCH



ION TOWER



CROWNE ARTICULATING TOP



CROWNE ARTICULATING TOP IN DOWN POSITION



SOLSTICE DC 250 WINDSHIELD, HIGH PROFILE WITH CLEAR GLASS WITH BLACK FRAME



STANDARD SOLSTICE DC 250 WINDSHIELD, LOW PROFILE WITH SMOKED GLASS AND BLACK FRAME

FEATURE COMPARISON CHART

● Standard ○ Optional - Not Available

		CRUISER		SUNLINER		SOLSTICE			GRAND MARINER	CROWNE				
		LX			SPORT		DC	RD		SL	DL	SL TE	DL TE	
COVERS & TOPS	9' Bimini	●	-	-	-	-	-	-	-	-	-	-	-	
	10' Bimini	-	●	●	-	●	●	-	-	-	-	-	-	
	12' Bimini	-	○	○	-	○	○	-	●	-	-	-	-	
	12' Lighted Bimini	-	○	○	-	○	○	-	○	-	-	-	-	
	10' Electric Power Top Bimini (with Bimini LED Lights)	-	○	○	-	○	○	-	○	-	-	-	-	
	Double Bimini	-	○	○	-	○	○	-	○	-	-	-	-	
	Double Bimini (Req Tower/Arch)	-	-	-	○	○	○	-	○	○	○	○	○	
	Ion Tower	-	-	-	-	○	○	-	○	-	-	-	-	
	Ultra Tower	-	-	-	-	○	○	-	○	-	-	-	-	
	Deluxe Tower	-	-	-	●	-	-	-	-	-	-	-	-	
	Sport Arch with Acrylic Sun Shades & Power Lift	-	-	-	-	-	-	-	-	-	●	●	●	●
	EVO 2.0 Tower with Bimini & Power Lift	-	-	-	-	○	○	-	-	-	-	-	-	
	Articulating Top	-	-	-	-	-	-	-	-	-	○	-	○	-
	Mooring Cover (EZ-Clip System)	-	●	●	●	●	●	●	●	●	-	-	-	-
	Snap Mooring Cover	○	-	-	-	-	-	-	-	-	●	●	●	●
	Seat Covers	-	○	○	○	○	○	○	○	○	-	-	-	-
Full Enclosure (with Double Bimini)*	-	○	○	-	○	○	-	-	-	-	-	-	-	
HELM HIGHLIGHTS	DC Receptacle, 12V	-	●	●	●	●	●	●	●	●	●	●	●	
	Digital Depth Sounder	-	○	○	○	-	-	-	-	●	●	-	-	
	Tachometer	-	●	●	●	●	●	●	●	●	●	-	-	
	GPS Speedometer	-	●	●	●	●	●	●	●	●	●	-	-	
	Lockable Glovebox	-	○	●	●	●	●	●	●	●	●	●	●	
	Helm Storage Door	●	●	●	●	-	●	-	-	●	●	●	●	
	Rearview Mirror	-	○	○	○	○	○	○	○	○	○	○	○	
	Raised Helm	-	-	○	○	○	-	-	●	-	-	-	-	
	Tilt Steering	○	○	●	●	●	●	●	●	●	●	●	●	
	Rear-Facing Camera (Req Arch/Tower & Glass Dash)	-	-	-	-	-	-	-	-	○	○	○	○	
	Wireless Mobile Phone Charging Pad	-	○	○	○	○	-	○	●	-	-	-	-	
	Glass Dash	-	-	-	-	-	-	-	-	○	○	○	○	

● Standard ○ Optional - Not Available

		CRUISER		SUNLINER		SOLSTICE			GRAND MARINER	CROWNE			
		LX			SPORT		DC	RD		SL	DL	SL TE	DL TE
COMFORT & CONVENIENCE	Single Battery Disconnect Switch	-	○	○	○	○	○	-	-	-	-	-	-
	Double Battery Selector Switch	-	○	○	○	○	○	○	●	●	●	●	●
	120V Battery Charger	-	○	○	○	○	○	○	○	○	○	●	●
	Changing Room	-	○	○	○	○	-	○	○	○	○	○	○
	Stainless Steel Cupholders	-	○	○	○	●	●	●	●	●	●	●	●
	Extended Rear Deck/Swim Platform	-	○	●	●	●	●	●	●	●	●	-	-
	LED Docking Light Pods	○	-	-	-	○	○	○	-	-	-	-	-
	Fence Mounted Docking Lights	-	○	●	●	●	●	●	●	●	●	●	●
	Upholstered Fence Interior	-	-	-	-	-	-	-	○	●	●	●	●
	5.5" Quick Release Fender System	-	○	○	○	○	○	○	●	●	●	●	●
	Two Add'l 5.5" Fenders with Straps	-	○	○	○	○	○	○	○	○	○	○	○
	8.8" Quick Release Fender System	-	○	○	○	○	○	○	○	○	○	○	○
	Two Add'l 8.8" Fenders with Straps	-	○	○	○	○	○	○	○	○	○	○	○
	Fire Extinguisher <i>(Manual)</i>	-	○	○	○	●	●	●	●	●	●	●	●
	Gate Floor Stops	●	●	●	●	●	●	●	●	●	●	●	●
	Stainless Steel Grill	-	○	○	○	○	-	○	○	-	-	-	-
	4-step Ladder with Platform	-	●	-	-	-	-	-	-	-	-	-	-
	4-step Telescoping Stainless Steel Ladder	-	○	●	●	●	●	●	●	●	●	●	●
	Midship Mooring Eyes	-	○	○	○	○	○	○	○	○	○	○	○
	Stainless Steel Safety Railing	-	○	○	○	○	○	-	○	●	-	●	-
Stainless Steel Refrigerator	-	-	-	-	○	-	-	○	○	○	○	○	
Pressurized Faucet	-	-	-	-	○	-	-	○	○	○	○	○	

*Note: Full canvas enclosures should only be used while the boat is at anchor or rest and never when engines or generators are running. See owner's manual.

FEATURE COMPARISON CHART *(Continued)*

● Standard ○ Optional - Not Available

		CRUISER		SUNLINER		SOLSTICE			GRAND MARINER	CROWNE			
		LX			SPORT		DC	RD		SL	DL	SL TE	DL TE
FISHING FEATURES	In-Floor Rod Locker <i>(Req FC Layout)</i>	-	○	-	-	-	-	-	-	-	-	-	-
	Fish Finder with Depth Sounder <i>(Hook2-4X)</i>	○	○	○	○	●	●	●	-	-	-	-	-
	VesselView™ Link <i>(Req PA Pkg I or II/Simrad)</i>	-	○	○	○	○	○	○	●	○	○	●	●
	Simrad GO7 GPS <i>(GPS Chartplotter & Fish Finder)</i>	-	○	○	○	○	○	○	●	○	○	-	-
	Simrad GO9 GPS <i>(GPS Chartplotter & Fish Finder)</i>	-	○	○	○	○	○	○	○	○	○	●	●
	Gate, Half Bow for Trolling Motor	●	○	-	-	-	-	-	-	-	-	-	-
PACKAGES	Select Trim	-	○	-	-	-	-	-	-	-	-	-	-
	Premier Trim	-	○	○	○	-	-	-	-	-	-	-	-
	Prestige Trim	-	-	-	-	○	○	○	-	-	-	-	-
	Convenience Pkg	-	○	○	○	○	○	○	○	-	-	-	-
	Interior Lighting Pkg <i>(LED RGB)</i>	-	○	○	○	○*	○	○	●	○	○	○	○
	Total Lighting Pkg <i>(LED RGB)</i>	-	-	-	-	○*	○	○	○	○	○	○	○
	Performance Pkg Level 1 <i>(Adds a 25" Partial Center Tube)</i>	-	○	○	-	-	-	-	-	-	-	-	-
	Performance Pkg Level 2 <i>(Three 25" Tubes, 37 gal fuel tank & Ski Tow Bar)</i>	-	○	○	●	-	-	-	-	-	-	-	-
	Performance Pkg Level 2 <i>(Three 25" Tubes, 37 gal fuel tank In-Floor Storage & Ski Tow Bar)</i>	-	-	-	-	○	●	-	○	●	●	-	-
	Performance Pkg Level 3 <i>(Three 25" Tubes, In-Floor Storage, 63 gal Tank & Ski Tow Bar/Pylon)</i>	-	-	-	-	○	○	-	○	○	-	-	-
	Performance Pkg Level 3.5 <i>(Three 27" Tubes, 63 gal Tank)</i>	○	○	○	○	-	-	-	-	-	-	-	-
	Performance Pkg Level 3.5 <i>(Three 27" Tubes, In-Floor Storage, 63 gal Tank, & Ski Tow Bar/Pylon)</i>	-	-	-	-	○	○	●	○	○	○	-	-
	Twin Engine Platform	-	-	-	-	-	-	-	-	-	-	●	●
	Salt Water Pkg	○	○	○	○	○	○	○	○	○	○	○	○
In-Floor Storage <i>(Req Performance Level 2 or 3.5)</i>	○	○	○	○	-	-	-	-	-	-	-	-	
STEREO UPGRADE PACKAGE	JL Audio Zone Control Stereo, 8 JL Speakers <i>(Sol RD inc 2 Head Units, EGDH only 6 Speakers)</i>	-	-	-	-	●	●	●	●	●	●	●	●
	JL Audio Diamond Sound System <i>(Amp, Subwoofer, Stereo & 6 Speakers on Cruiser/Sunliner or 8 Speakers on Solstice [EGDH 6], Grand Mariner, and Crowne models)</i>	-	○	○	○	○	○	○	○	○	○	○	○
	JL Audio Platinum Sound System <i>(2 DSP Amps, 2 Subwoofers, Stereo & 8 Speakers. EGDH - 6 speakers)</i>	-	-	-	-	○	○	○	○	○	○	○	○
	Clarion Bluetooth Stereo <i>(4 Clarion Speakers)</i>	-	●	●	●	-	-	-	-	-	-	-	-
	Tower Speakers <i>(Require Tower & JL Diamond/Platinum Upgrade)</i>	-	-	-	-	○	○	-	○	-	-	-	-

*Audio options may vary by layout.

● Standard ○ Optional - Not Available

		CRUISER		SUNLINER		SOLSTICE			GRAND MARINER	CROWNE			
		LX			SPORT		DC	RD		SL	DL	SL TE	DL TE
FENCE	Black Anodized Fence & Rubrail	-	○	○	○	○	○	○	○	●	●	●	●
	Stainless Steel Rubrail	-	-	-	-	○	○	○	○	●	●	●	●
FURNITURE	Adjustable Height Seat Base	-	○	○	○	○	●	○	-	○	○	○	○
	Lux Helm Seat (<i>Lowback Recliner</i>)	-	●	●	●	-	-	-	-	-	-	-	-
	UltraLux Helm Seat (<i>Highback Recliner</i>)	-	○	○	○	●	●	●	●	●	●	●	●
	UltraLux Helm Seat with Flip-up Bolster	-	○	○	○	○	○	○	-	○	○	○	○
	USB Charging Ports (<i>in furniture</i>)	-	●	●	●	●	●	●	●	-	-	-	-
	Jump Seat	-	○	○	○	○	○	○	○	-	-	-	-
	Swim Seat (<i>Req 3 tubes</i>)	-	-	-	-	○	○	-	○	○	○	-	-
	Fishing Seat Upgrade	-	○	-	-	-	-	-	-	-	-	-	-
	Table with Drink Holders	○	●	-	-	-	-	-	-	-	-	-	-
	Woodgrain Luxury Sport Table Upgrade	-	-	●	●	●	●	●	●	●	●	●	●
	Black Acrylic Table Upgrade with Stemware Holders	-	○	○	○	○	○	○	○	○	○	○	○
	Articulating/Folding Teak Table Upgrade	-	-	-	-	-	-	-	-	-	○	○	-
PERFORMANCE & HANDLING	Xtreme Steering (<i>Engines<115HP; N/A Hyd. & PAS Steering</i>)	-	○	○	-	○	-	-	-	-	-	-	-
	Hydraulic Steering	-	○	○	●	○	○	●	●	●	●	-	-
	Full-Length Keel	●	●	●	●	●	●	●	●	●	●	●	●
	Lifting Strakes	○	○	○	●	○	●	●	○	●	●	●	●
	Mercury® ActiveTrim	○	○	○	○	○	○	○	○	○	○	○	○
	Polished Tubes (<i>Warranty Excluded</i>)	-	-	-	-	-	-	-	○	○	○	○	○
	Stainless Steel Ski Tow Bar	○	○	○	○	○	○	○	○	○	○	-	-
	Stainless Steel Ski Tow Pylon (<i>Removable</i>)	-	-	-	-	○	○	-	○	○	○	-	-

*Interior and Total Lighting Packages come standard with C-Zone digital switching technology on Solstice 230 and 250 models.

FLOORPLANS



NEED HELP CHOOSING THE BEST FLOORPLAN FOR YOUR FAMILY?

Discover your boat at harrisboats.com/find-my-harris.html

CS



CW



CWDH



CWEB



CWEC



DL



CROWNE

GRAND MARINER

SOLSTICE

SUNLINER

CRUISER

CRUISER LX

	CS	CW	CWDH	CWEB	CWEC	DL
CROWNE						●
GRAND MARINER			●			
SOLSTICE		●	●			
SUNLINER		●	●	●		
CRUISER	●	●	●		●	
CRUISER LX	●					

KEY

- CS** L Group
- CW** Center Walkthrough
- CWDH** Center Walkthrough with Dual Helm Seat
- CWEB** Center Walkthrough with Universal Bar on Port Side
- CWEC** Center Walkthrough with Entertainment Center
- DL** Dual Rear-facing Loungers
- DLDH** Dual Rear-facing Loungers with Dual Helm Seat
- DLEB** Dual Rear-facing Lounger with Entertainment Bar and Pressurized Sink
- EGDH** Entertainment Galley with Dual Helm Seats
- FC** Fish and Cruise
- SL** Single Rear-facing Lounger
- SLDH** Single Rear-facing Lounger with Dual Helm Seats
- SLDDH** Single Rear-facing Lounger with Two Dual Helm Seats
- SLEB** Single Rear-facing Lounger with Entertainment Bar and Pressurized Sink
- SLEC** Single Rear-facing Lounger with Entertainment Center

DLDH



DLEB



EGDH



FC



SL



SLDH



SLDDH



SLEB



SLEC



●	●			●				●	
				●	●	●			●
		●		●	●				●
				●	●	●			
			●	●	●				
			●						

FLOORPLANS

CROWNE *All Crowne floorplans available with both single and twin outboard engines*

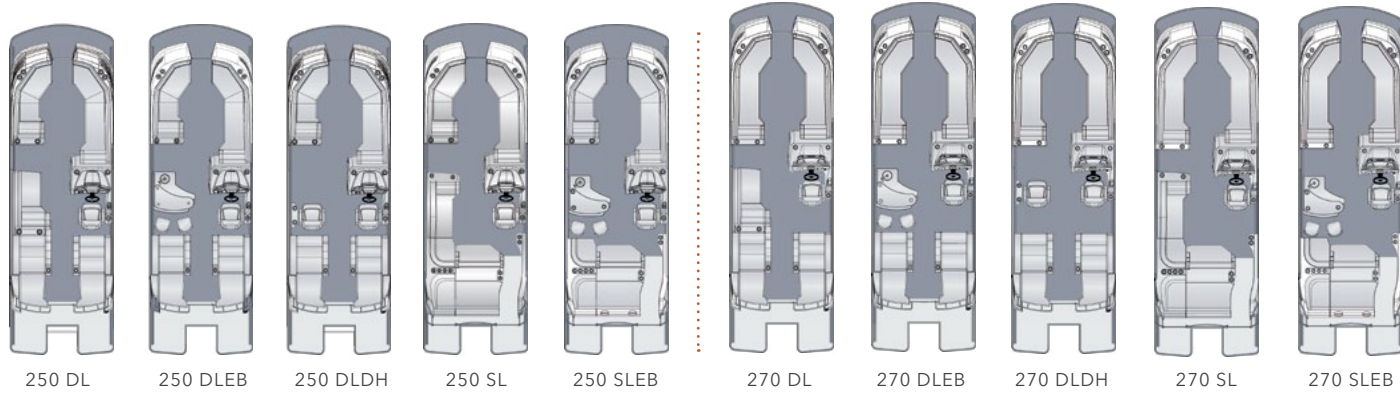

FLOORPLAN KEY

- CS** L Group
- CW** Center Walkthrough
- CWDH** Center Walkthrough with Dual Helm Seat
- CWEB** Center Walkthrough with Universal Bar on Port Side
- CWEC** Center Walkthrough with Entertainment Center
- DL** Dual Rear-facing Loungers
- DLDH** Dual Rear-facing Loungers with Dual Helm Seat
- DLEB** Dual Rear-facing Lounger with Entertainment Bar and Pressurized Sink
- EGDH** Entertainment Galley with Dual Helm Seats
- FC** Fish and Cruise
- SL** Single Rear-facing Lounger
- SLDH** Single Rear-facing Lounger with Dual Helm Seats
- SLDDH** Single Rear-facing Lounger with Two Dual Helm Seats
- SLEB** Single Rear-facing Lounger with Entertainment Bar and Pressurized Sink
- SLEC** Single Rear-facing Lounger with Entertainment Center
- * 2-Piece Port Bow Grouping Available

GRAND MARINER

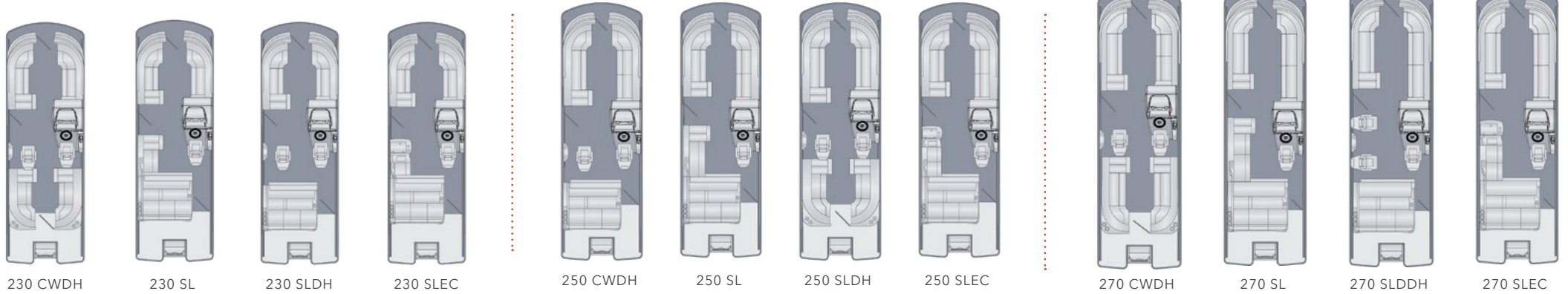

SOLSTICE

SOLSTICE DC

SOLSTICE RD

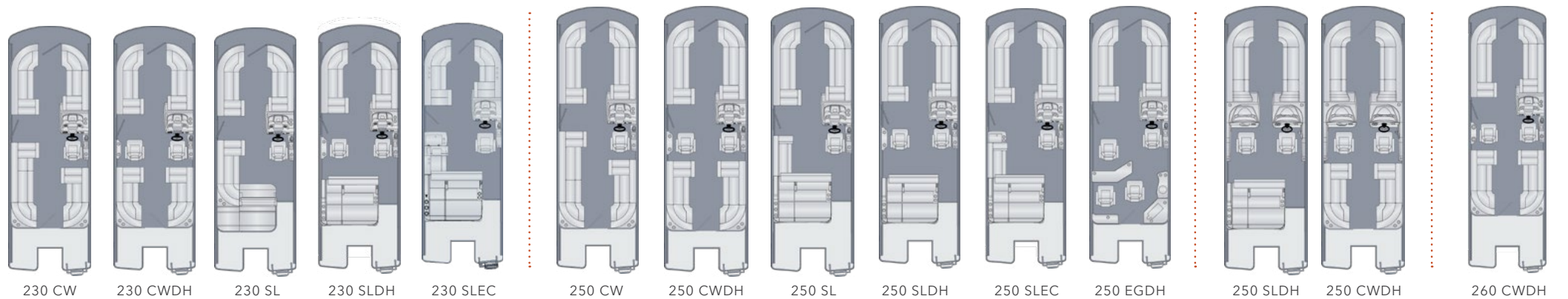

SUNLINER

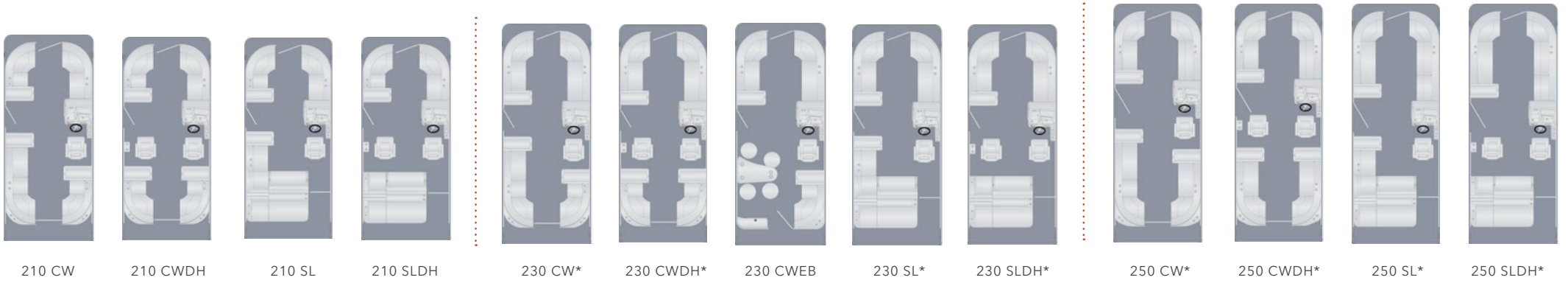

210 CW 210 CWDH 210 SL 210 SLDH 230 CW* 230 CWDH* 230 CWEB 230 SL* 230 SLDH* 250 CW* 250 CWDH* 250 SL* 250 SLDH*

CRUISER

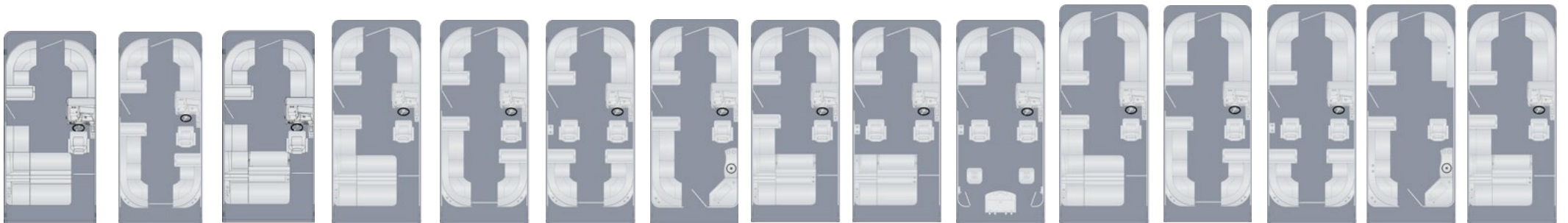

190 CS 190 CW 190 SL 210 CS 210 CW 210 CWDH 210 CWEC 210 SL 210 SLDH 210 FC 230 CS* 230 CW* 230 CWDH* 230 CWEC 230 SL*

CRUISER LX

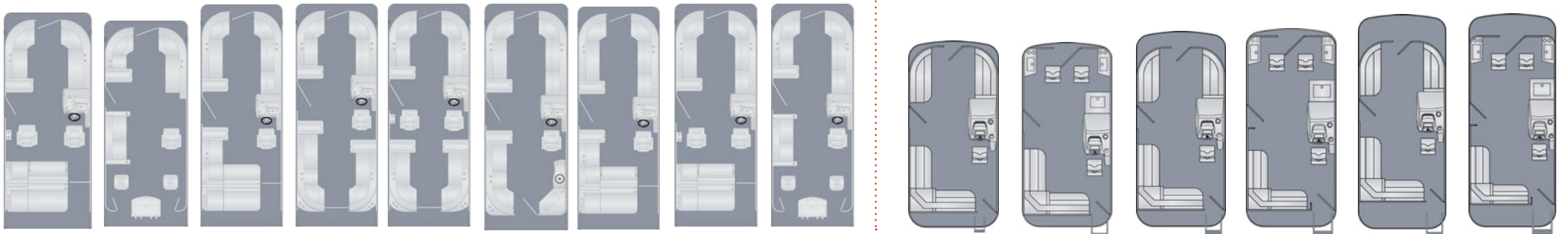

230 SLDH* 230 FC 250 CS* 250 CW* 250 CWDH* 250 CWEC 250 SL* 250 SLDH* 250 FC 160 CS 160 FS 180 CS 180 FS 200 CS 200 FS

WHAT ARE YOU WAITING FOR?



HARRIS®

1111 North Hadley Road
Fort Wayne, IN 46804

HARRISBOATS.COM