

# 2016 Log



Date	Topic	Page	Note
January 6	Frame Style	E-3	Change the name of "Scribe Trim" to "Quarter Round"
January 22	Hardware	I-1,3	Effective on Feb. 1 <sup>st</sup> , Additional Hinge Color for Pure White Shutters; Available in Late March
January 22	Appendix	N-1	Effective on Feb. 1 <sup>st</sup> , Additional Hinge Color for Pure White Shutters; Available in Late March
January 22	Bifold	J1-15,18,19	Effective on Feb. 1 <sup>st</sup> , Single direction Bi-fold /Multi-fold will be available for Frame Hinged Bifold Track Shutters
March 5	Bypass	J2-11	Add details for New Nylon Guide
March 19	Divider Rail	H	Add "Cut Out" for 84" panel height limit without divider rail is for Wood French Door installed with button catches & Wood Bypass and bi-fold track shutters.
March 24	Bypass	J2-1,11	Change "2014 Track Shutters-Bypass" to "2016 Track Shutters-Bypass" Change "Picth of Track" to " Separation of Track"

# *Normandy® Shutters*

Table of Contents		Page
a.	Features & Benefits	ND a-1
b.	Colors & Louvers	ND b-1
c.	Stiles	ND c-1
d.	Panel Configurations	ND d-1
e.	Frame Styles	ND e-1
f.	General Product Specifications	ND f-1
g.	Tilt Rods	ND g-1
h.	Divider Rails	ND h-1
i.	Hardware	ND i-1
j.	Track Shutters	ND j-1
k.	Special Options	ND k-1
l.	Specialties	ND l-1
m.	Pricing, Options & Surcharges	ND m-1
n.	Appendix	ND n-1
o.	RF Motorized Shutter	ND o-1

Effective 2008

## Features and Benefits

- Brings a touch of timeless elegance to your home. The **textured finish of Normandy shutters** blends the tranquility of nature with distinctive luxury.
- Normandy is treated with our exclusive **Prescription Wood Conditioning™** technique according to the moisture content of the final installation location to reduce post-installation shrinking and swelling.
- A wide range of **frames with inserts** that keep installation screws out of sight for a clean and decorative look to match any style and preference.
- **Reinforced engineered stiles** -- Multiple layers of wood bonded together to reinforce durability to the core of the stile, which results in a robust support system for the shutter panel.
- Multiple stile options available in various sizes to accommodate different window configurations. **Astragal (solid color shutters only) or Rabbet stiles** provide a natural light block between panels.
- Employs **mortise and tenon joinery** that resists shear and racking forces endured by shutters and ensures prolonged stability and durability.
- Quick and easy on-site installation with the **pre-installed magnets and hinges**, as well as **pre-mitered frames and slotted keyholes**.
- Labor-intensive **hand finishing process** involves **multiple sequences of sanding and coating** with fine layers of stain or paint for a brilliant, lustrous finish.
- Personalize shutters with **special options**. Choose from hidden or offset tilt rods, double-hung panels, café shutters, track systems, specialty shapes and many more.
- **Special panel and frame designs** are finely crafted to accommodate unique window configurations. Create unity or attract attention with Normandy's exclusive decorative elements.
- Available in **classic paint and radiant stain** that harmonize into the style of any home.
- A guarantee of Norman's exemplary quality with a **lifetime limited warranty on materials and workmanship**.

# Colors & Louvers

Solid Colors	Louvers	
001 Pure White	Elliptical	
003 Silk White		
004 Bright White		
006 Pearl		
009 Creamy		
012 Crisp Linen		
030 Moondust		
046 Ice		
<b>Stain Colors*</b>		
108 Rustic Gray		
110 Limed White		
205 Goldenrod		
211 Cherry		
221 Black Walnut		
227 Red Oak		
229 Rich Walnut		
230 Old Teak		
231 Spring Rose		
232 Red Mahogany		
233 Dark Mahogany		
237 Wenge		
242 Auburn		
249 Acorn		
250 Sumatra		
<b>Optimal™*</b>		
Optimal™ safeguards your window treatments from accumulating airborne germs and disease-causing bacteria so that you have on less thing to worry about.		
** Custom sheen options available		

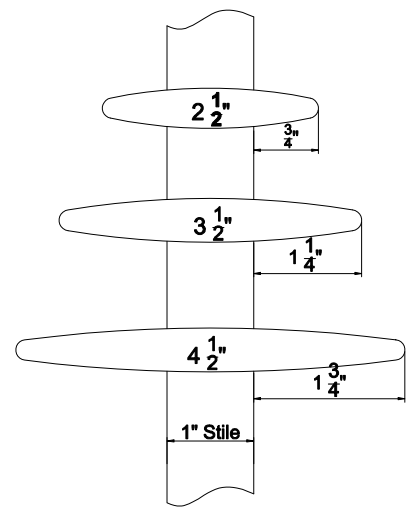

Colors available till June 30, 2013		
Color Code	Color Name	Note
011	Cameo	Discontinue on June 30, 2013
013	Bisque	Discontinue on June 30, 2013
103	Maple Sugar	Discontinue on June 30, 2013
105	Hermitage Green	Discontinue on June 30, 2013
206	Pecan	Discontinue on June 30, 2013
214	Cocoa	Discontinue on June 30, 2013
222	Light Pine	Discontinue on June 30, 2013
224	Mellow Beech	Discontinue on June 30, 2013
226	Chestnut	Discontinue on June 30, 2013

# Normandy® Shutters

## Stiles Options

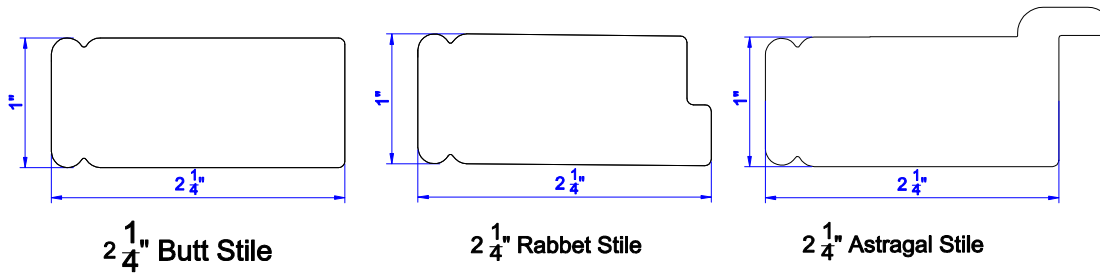
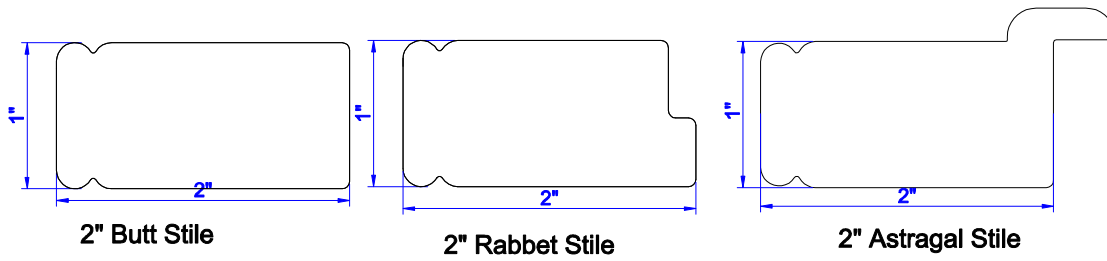
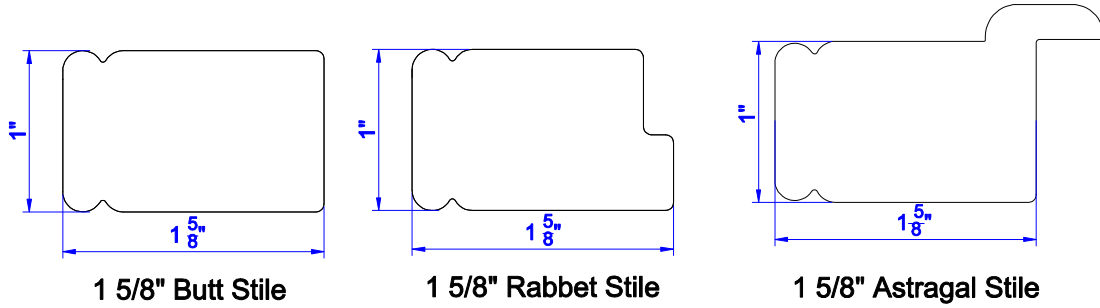

## Stile between panel closure

### Single panel

#### I) Panel width < 9"

- Rabbeted stile (Deco frame, L frame, Z frame and Hang strip beside panel)
  - 1 <sup>5</sup>/<sub>8</sub>"
  - 2" (default)
- Butt stile only (Hang strip behind panel)
  - 1 <sup>5</sup>/<sub>8</sub>"
  - 2" (default)

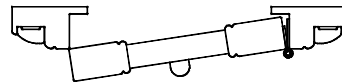
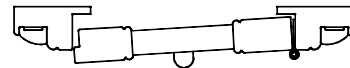

#### II) Panel width ≥ 9"

- Butt stile only
  - 1 <sup>5</sup>/<sub>8</sub>" ( Optional for panel width ≤ 12" )
  - 2" (default)

### 2 panels or more

- Astragal stile
  - 1 <sup>5</sup>/<sub>8</sub>" ( Optional for panel width ≤ 12" )
  - 2" (default)
- Rabbet stile
  - 1 <sup>5</sup>/<sub>8</sub>" ( Optional for panel width ≤ 12" )
  - 2"

## Panel Configurations

### Single Panel

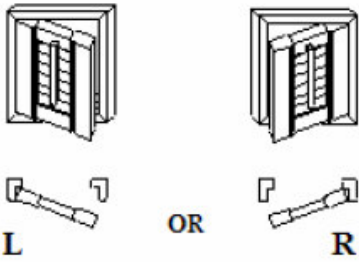

### 2 Panels

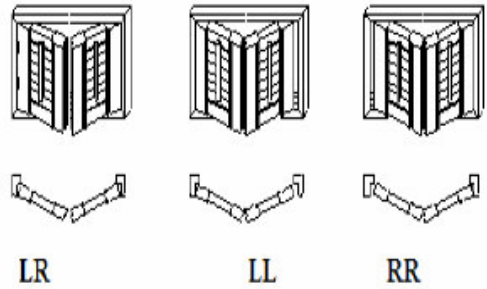

### 3 Panels

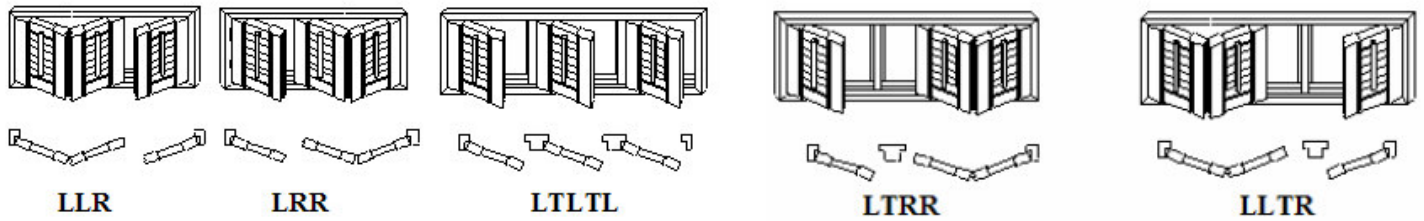

### 4 Panels

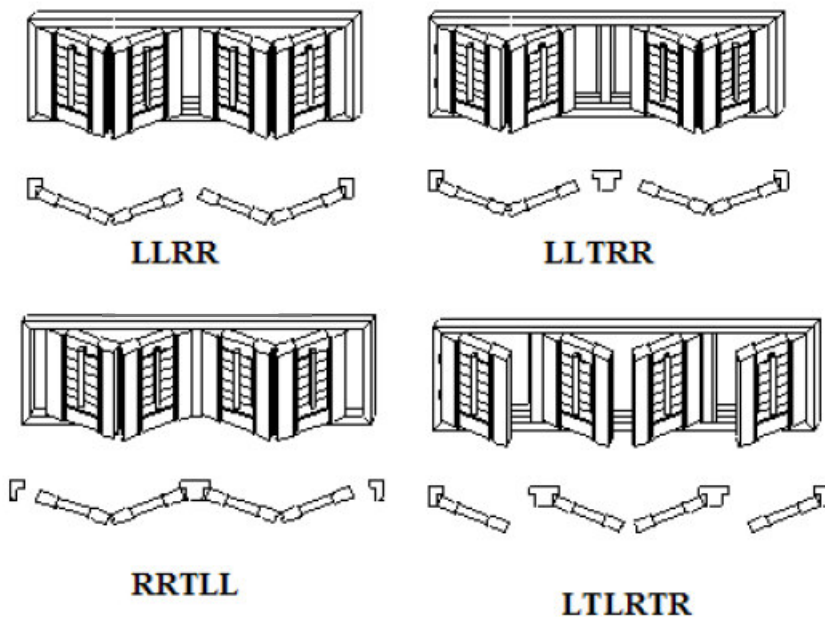

# *Normandy® Shutters*

## Panel Configurations (continued)

### 6 Panels



**LRTLRTL**

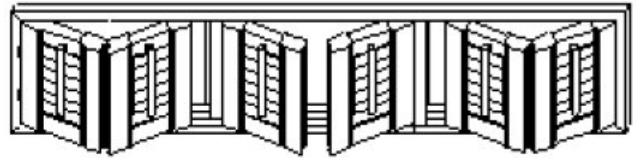

**LLTLRTR**

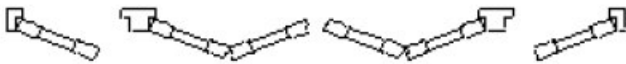

**LLLRRTL**

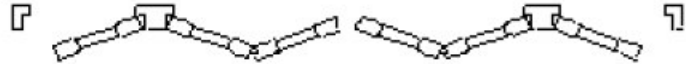

**RTLLRTL**



## Panel Configurations – Astragal Stile

- 2 Panels – LR

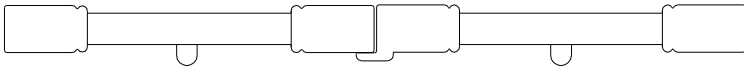

- 3 Panels - LRR

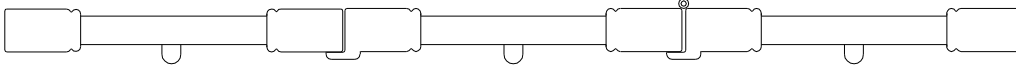

- 3 Panels – LLR

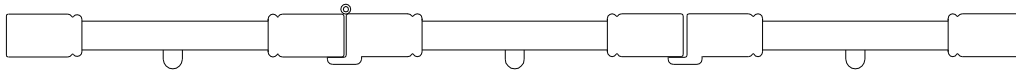

- 4 Panels - LLRR

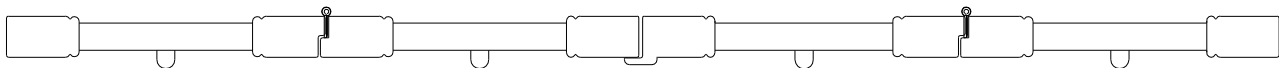

## Frame Styles

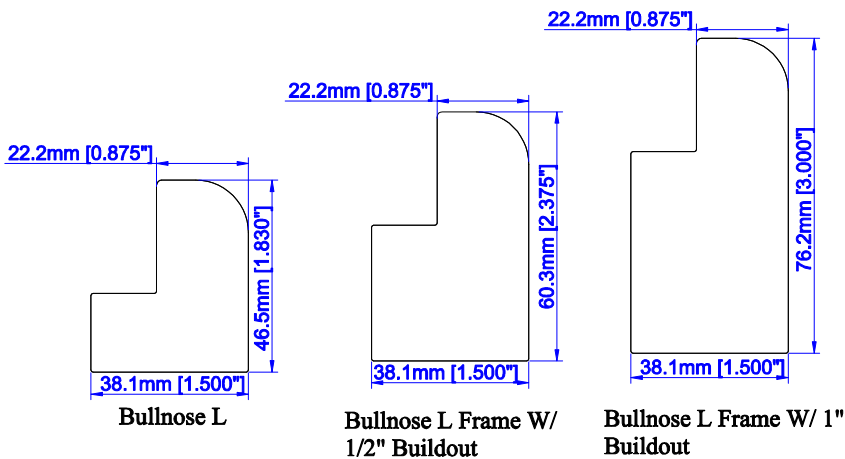
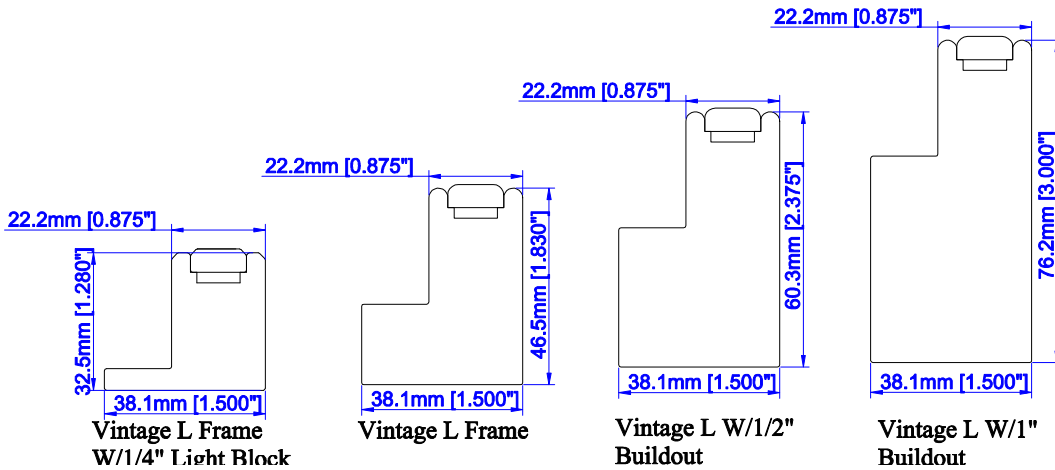
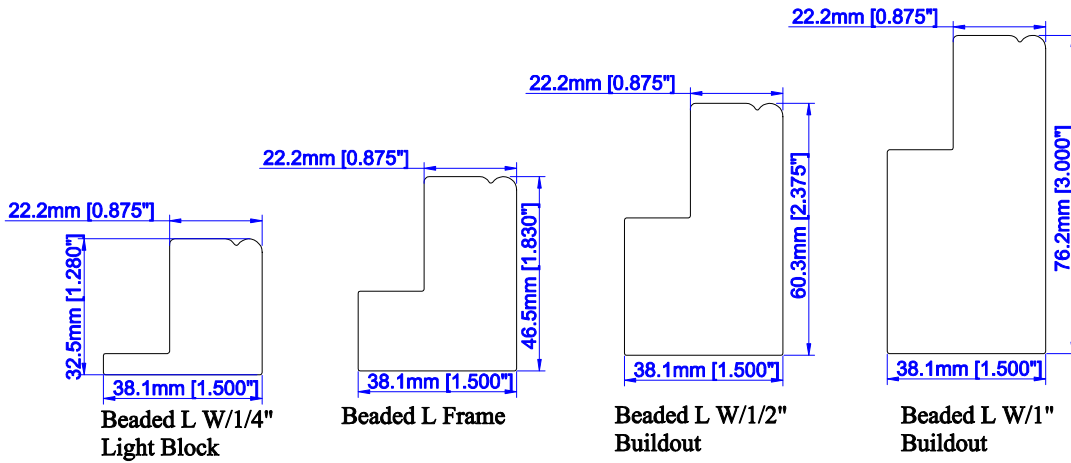

Also available

- Custom extensions\* up to 2" for L frames

\* Surcharge applies. Please see Options and Surcharges page for details.

## Frame Styles

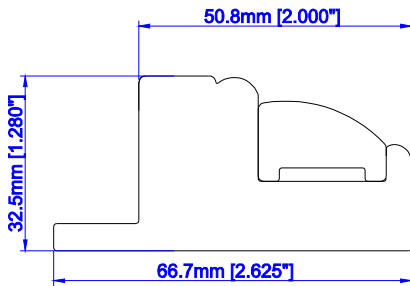

2" Camber Deco Frame

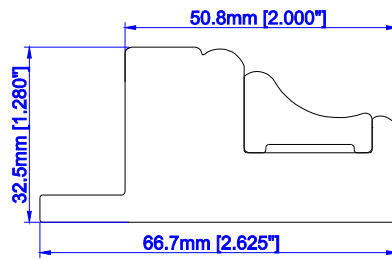

2" Classic Deco Frame

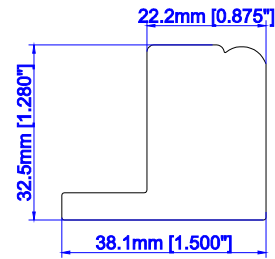

2" Deco Sill Plate

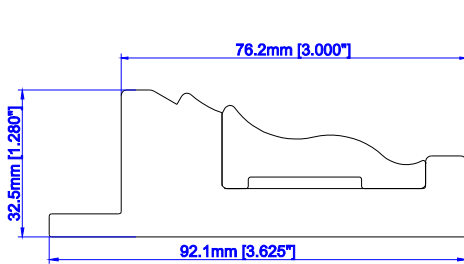

3" Ridge Deco Frame

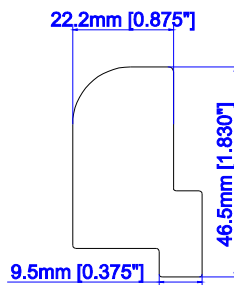

Tilt Out Z Frame

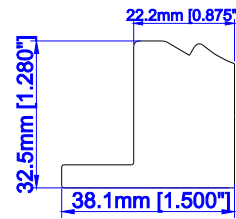

Ridge Deco Sill Plate

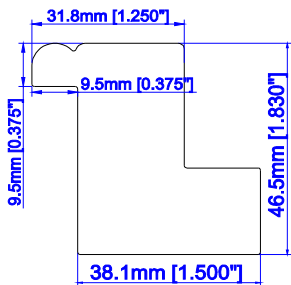

1 1/4" Beaded Z Frame

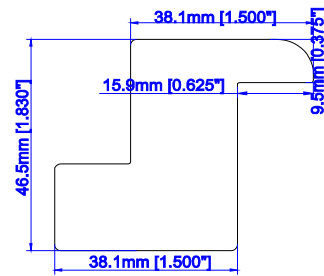

1 1/2" Bullnose Z Frame

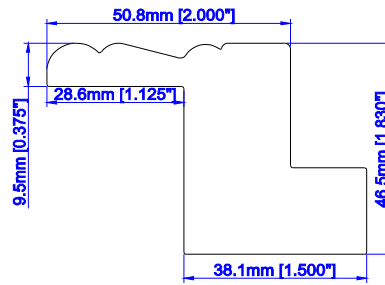

2" Bel Air Z Frame

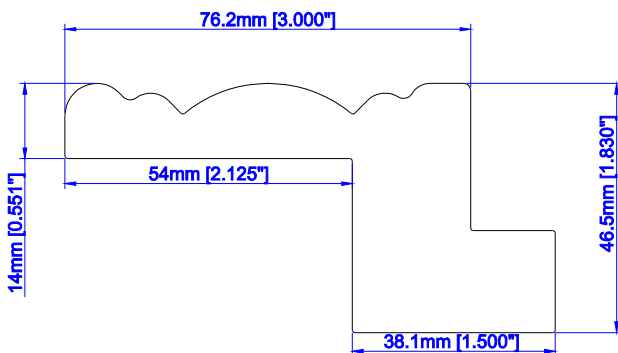

3" Crown Z Frame

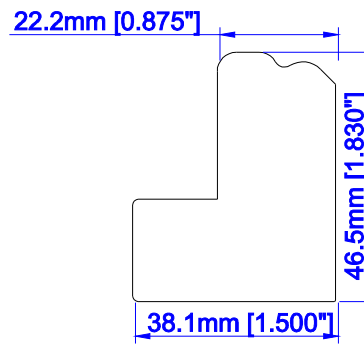

3" Crown Z Sill Plate

Also available

- Custom extensions\* up to 1" for Z frames
- 1/2", 1" and 1 1/2" standard extensions\* and custom extensions\* up to 2" for Deco frames
- Custom extensions\* up to 2" for hang strips (OM)

**Frame Styles**

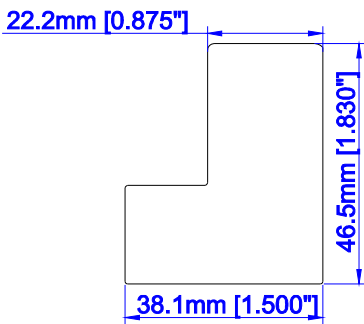

**1 1/2" Bullnose Z  
1 1/4" Beaded Z  
Sill Plate**

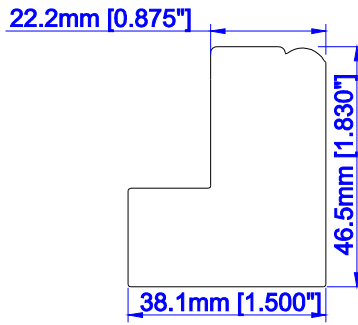

**2" Bel Air Z Sill Plate**

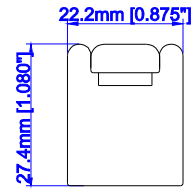

**Vintage Hang Strip**

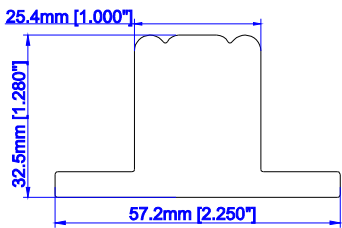

**1" T Post W/ 1/4" Light Block  
(Deco)**

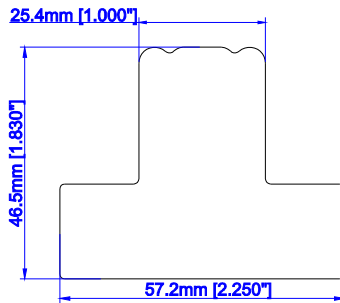

**1" T Post W/ 3/4" Light Block  
(L/Z/HS)**

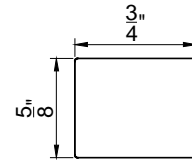

**Light Block**

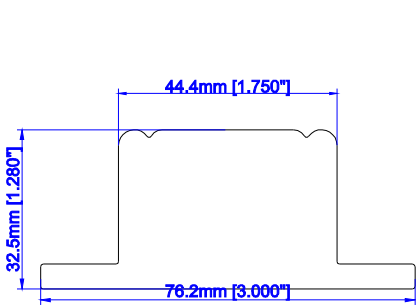

**1 3/4" T Post W/ 1/4" Light  
Block (Deco)**

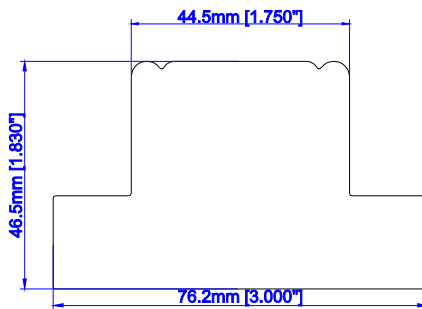

**1 3/4" T Post W/ 3/4" Light  
Block (L/Z/HS)**

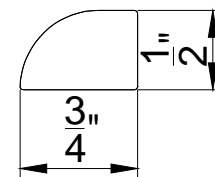

**Quarter Round**

# Normandy® Shutters

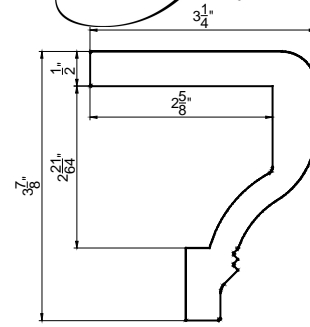
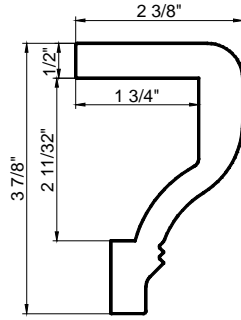
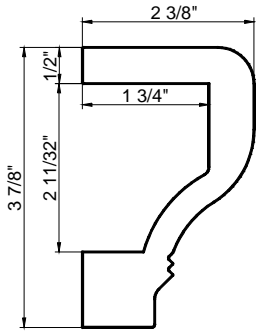

Curved Designer Sill Cap (L)    Curved Designer Sill Cap (D/HS)    Curved Designer Sill Cap (Z)

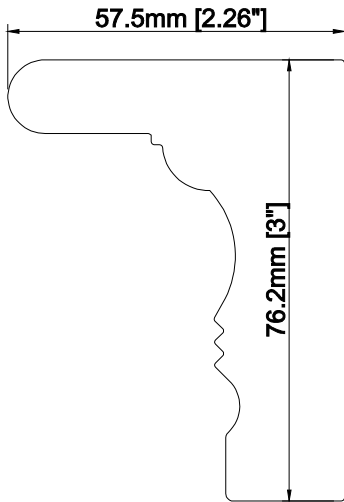

3" Deco Sill Frame

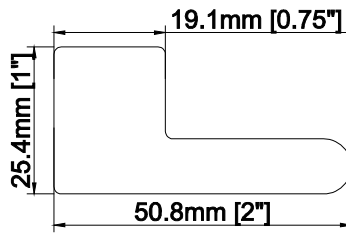

2" Sill Plate with 5/8" Light Block (L/Z)

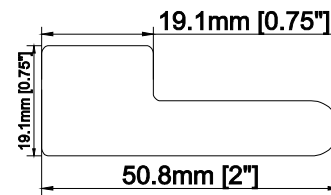

2" Sill Plate with 3/8" Light Block (L/Z)

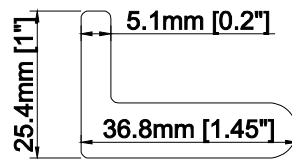

1.5" Sill Plate with 5/8" Light Block (Deco)

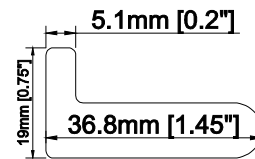

1.5" Sill Plate with 3/8" Light Block (Deco)

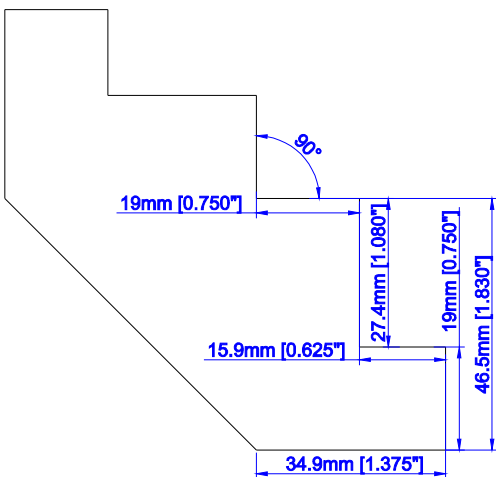

Corner Post W/ 3/4" Light Block (L/Z/HS)

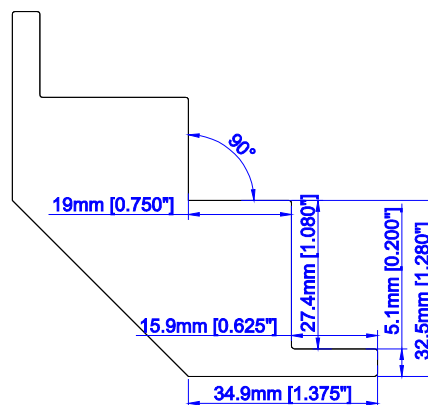

Corner Post W/ 1/4" Light Block (Deco)

Frame Styles

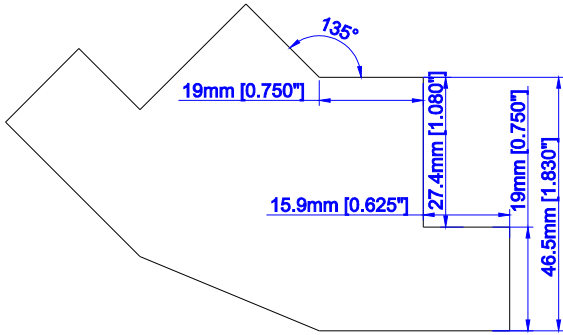

Bay Post W/ 3/4"  
Light Block (L/Z/HS)

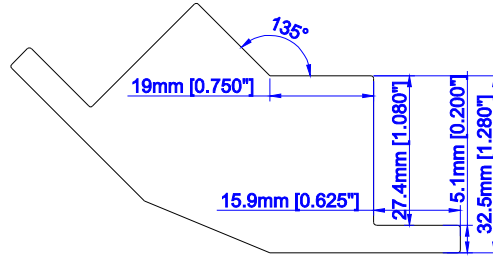

Bay Post W/ 1/4"  
Light Block (Deco)

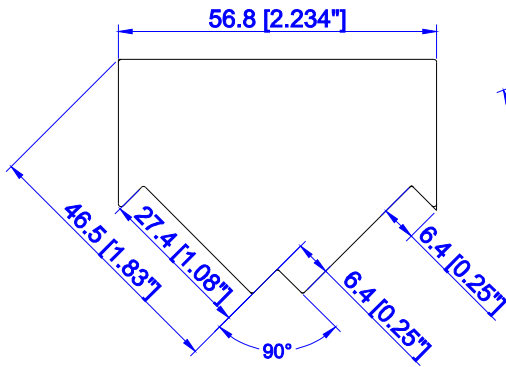

Slim Fit Corner Post for  
90 Degree (L/Z/HS)

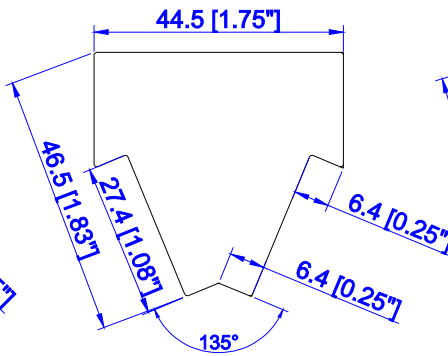

Slim Fit Bay Post for  
135 Degree (L/Z/HS)

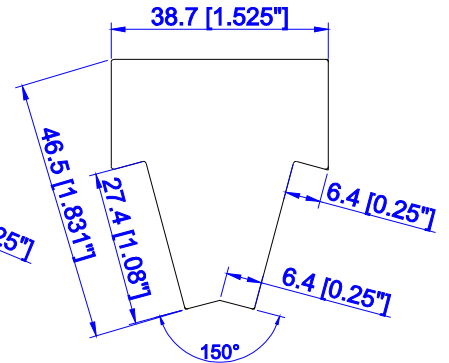

Slim Fit Bay Post for  
150 Degree (L/Z/HS)

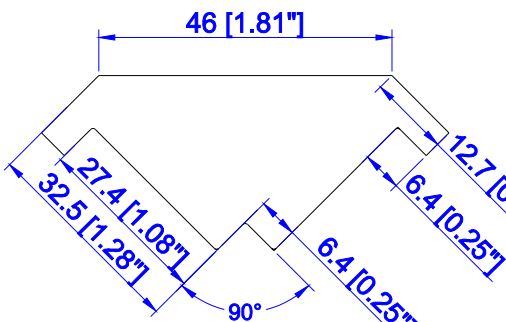

Slim Fit Corner Post for 90 Degree (D)

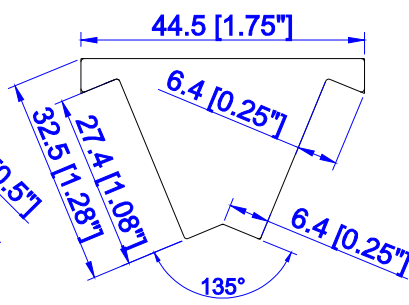

Slim Fit Bay Post for 135 Degree (D)

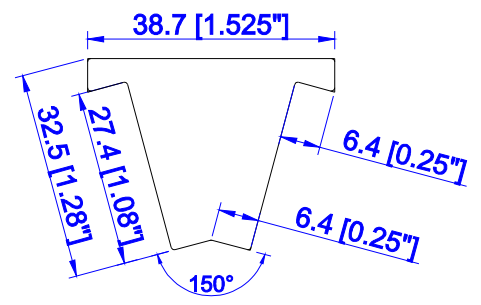

Slim Fit Bay Post for 150 Degree (D)

## Frame Styles

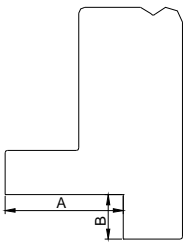

Notch Out

Beaded L Frame (A) \*

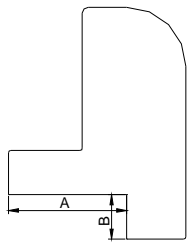

Notch Out

Bullnose L Frame (A) \*

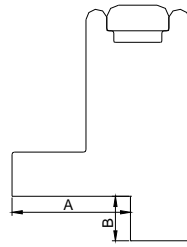

Notch Out

Vintage L Frame (A) \*

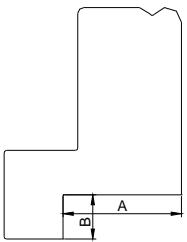

Notch Out

Beaded L Frame (B) \*

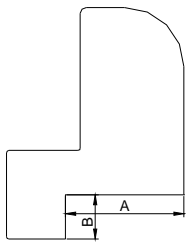

Notch Out

Bullnose L Frame (B) \*

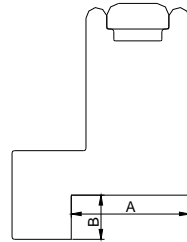

Notch Out

Vintage L Frame (B) \*

Also available

- Custom depth\* up to 2" / width\* up to 7½" for T Posts
- Custom angle bay posts\*

\* Surcharge applies. Please see Options and Surcharges page for details

Pre-drill L or Z frames:

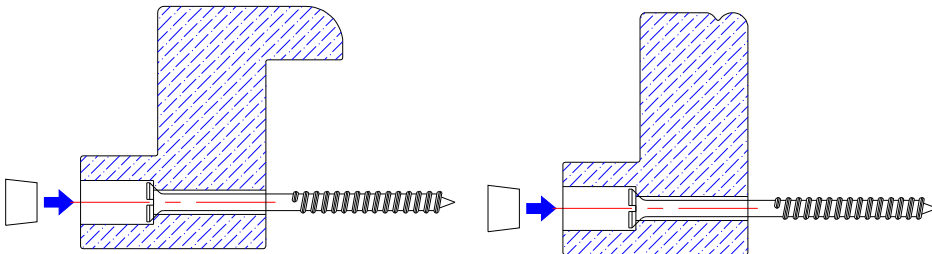



## General Product Specifications

<u>Description</u>	<u>Minimum</u>	<u>Maximum</u>
Single Panel Width (Regular)	6"	42" for 3.5"&4.5" louvers, 36" for other louver type
Single Panel Width (Bifold)	6"	26"
Single Panel Height	10"	133"
Shutter Width (Without T Post)	N/A	4x single panel width (bifold) + frame
Shutter Width (With T Post)	N/A	Unlimited (frame* pieces exceeding 142" will be spliced)
Shutter Height	N/A	133" + frame

\* For frame and stile exceeding 108", there will be a visible finger joint line in the middle.

### Shutters without bottom supports

Normandy shutters will be covered by our warranty for this application, subject to our standard specification limitations and the guidelines listed below:

#### All Normandy panel configurations:

- ◇ You must inform Norman Shutters of situations where shutters will not have bottom support when placing the initial order, or warranty will be considered void.
- ◇ Informing Norman Shutters when placing such orders ensures that the factory will add extra hinges to support the panel. This will reduce the probability of the panels sagging and increase shutter integrity.
- ◇ If you fail to notify Norman Shutters that the shutter will be used without a bottom support or used as doors, this will constitute a misapplication of the shutter. Consequently, you will be responsible for the cost of any RGA Reorder that is submitted.
- ◇ If you want a bifold shutter, a track must be ordered to support the panels.



## Tilt Rod

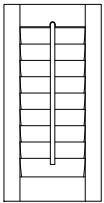

**Standard Tilt Rod  
Default Location**

In the middle of the panel on front side (default).

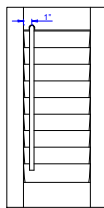

**Offset Tilt Rod\*  
Default Location**

On the front side of the panel and at 1" from the louver ends on the hinged side.  
Optional location: per your request.

**InvisibleTilt™ \***

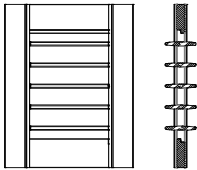

Louver tilting system embedded within panel stile. It is not available for 1<sup>7</sup>/<sub>8</sub>" louver. The tilting system is split when the number of louvers exceeds the limits as listed below:

Louver Size	Maximum Possible Louvers	Panel Height Range
2½"	24	54 ¾" – 57 ¼"
3½"	16	54 ¾" – 58"
4½"	12	54 ¾" – 60"

- For even numbers of louvers, the number of louvers operated by the top and the bottom tilting system will be the same.
- For odd numbers of louvers, the number of louvers operated by the bottom tilting system will be one more than the number of louvers operated by the top tilting system.
- **To ensure split tilt is included, always specify on the order.**

## Divider Rails

- A divider rail is an extra rail in the middle of the panel.
- Creates two sections in the panel so louvers can be operated independently.
- Strengthens the panel and enhances structural integrity.
- Divider rail is required for panel heights over 78”.
- 84” panel height limit without divider rail is for Wood French Door **Cut Out** installed with button catches & Wood Bypass and bi-fold track shutters.
- Custom Size(3”~7.875”) Divider Rail is available with surcharge.

### Specifications

- Standard width: 3”
- Default location: center of the panel unless specified otherwise

### Measurements:

- Window size:
  - Measure from the bottom of the window to the center of the divider rail.
- Max frame-to-frame:
  - Measure from the bottom of the frame to the center of the divider rail.
- Position:
  - Per customer’s specification. However, the divider rail may be adjusted to a lower or higher position, within our allowable deviation, to ensure reinforcement and aesthetics of the shutter.

When placing the order, please clearly specify if the divider rail position needs to line up with that of other shutter divider rails in the same room. Please also refer to the table below for the allowable deviation details.

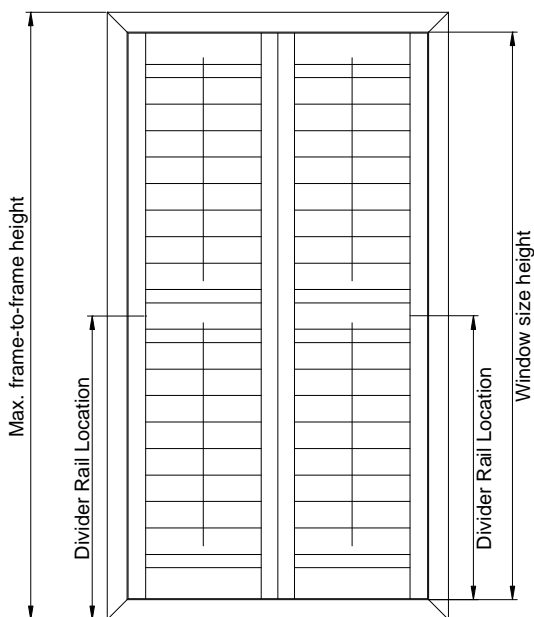

### Divider rail allowable deviations

Louver Size	Allowable + Deviation
2½"	1"
3½"	1½"
4½"	2"

**Hardware**

Hinges

Self-Mortise Hinge

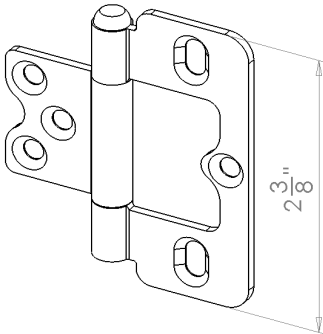

Bi-fold Hinge

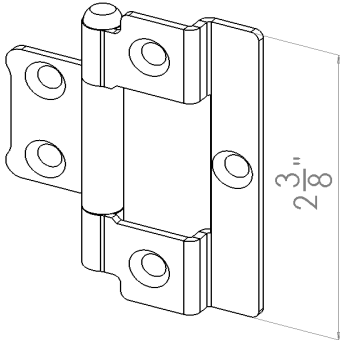

L Hinge

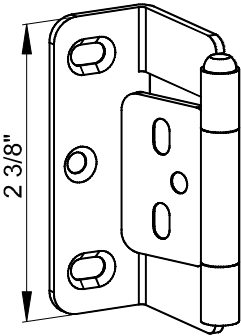

Hinges are available in :  
Pure White, Silk White, Bisque, Pearl, Bright Brass, Antique Brass, Black, Nickel plated and  
Stainless Steel\*

\* Surcharge applies. Please see Options and Surcharges page for details.

**Panel Lock:** (not available for 1.625" Stile)

**Available Material:** All

**Color:** Brush Nickel-Plated

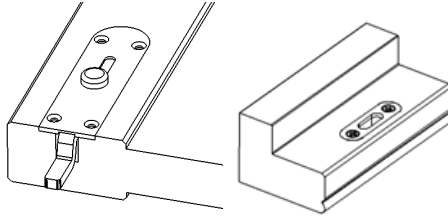

**Position:** (Only available on Bottom for Track Shutters with Bottom Track; For Regular, available on Top/Bottom/both Top and Bottom)

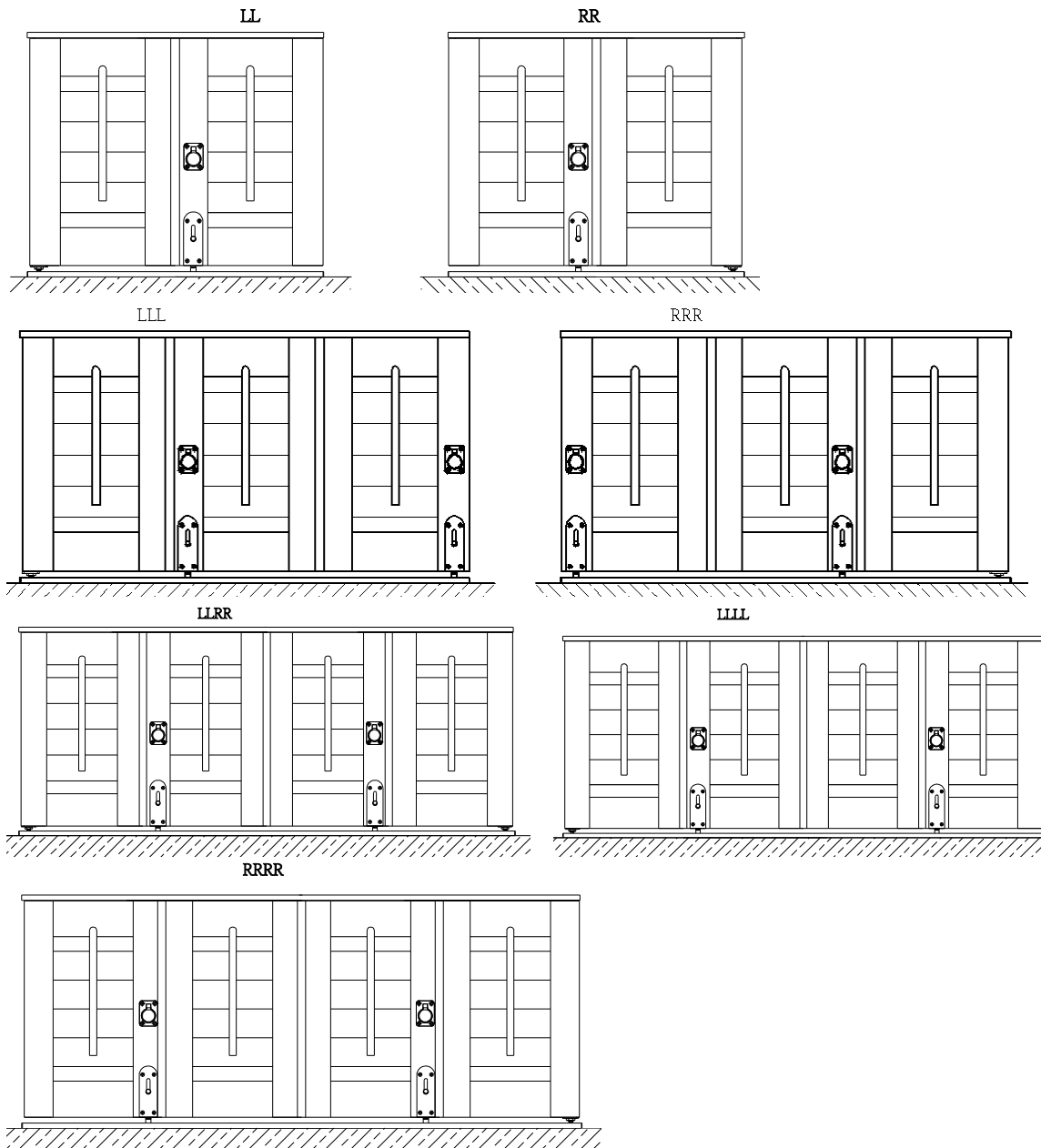

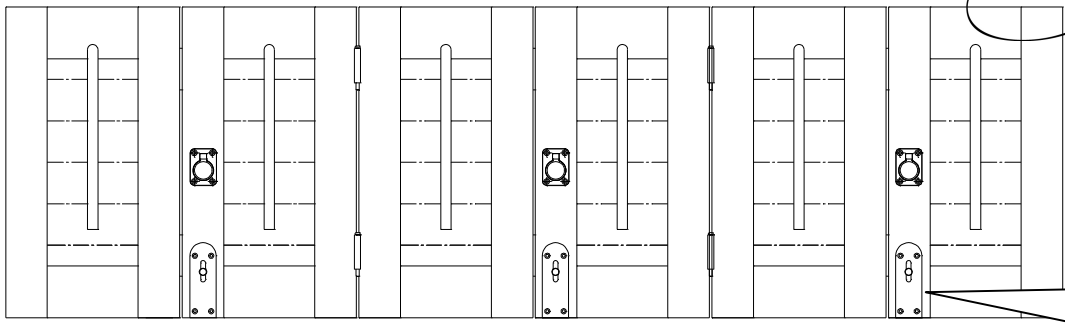

Default:  
Floating panels  
stacked to Right

Panel Config: FFFFFFF(R)

The Panel Lock location for both track system shutters and regular shutters would be the same. The general principle is that the Panel Lock position will avoid the stile which will install the spring-loaded guide at bottom (same stile as the Wheel carrier).

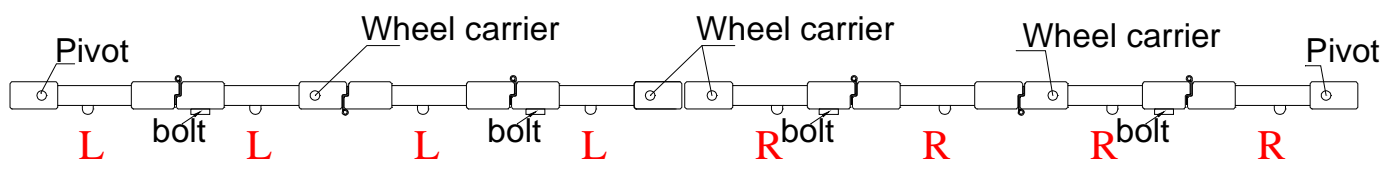

**Ring pull:** for easy opening and closing  
**(Not available for 1.625" Stile)**

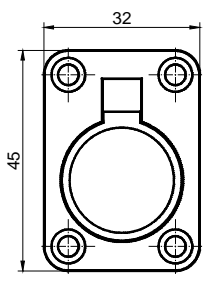

Please note the ring pull finish will match with the hinge finish.

Please see the matching chart below:

Hinge	Pure White	White	Bisque	Pearl	Black	Nickel	Brushed Nickel	Oil-Rubbed	Antique Brass	Bright Brass	Stainless Steel
Ring Pull	White	White	Bisque	Pearl	Black	Brushed Nickel	Brushed Nickel	Black	Antique Brass	Bright Brass	Brushed Nickel

**Position:** For different panel configuration, please refer to the location of Panel Lock to show on which stile the pull will be fixed.

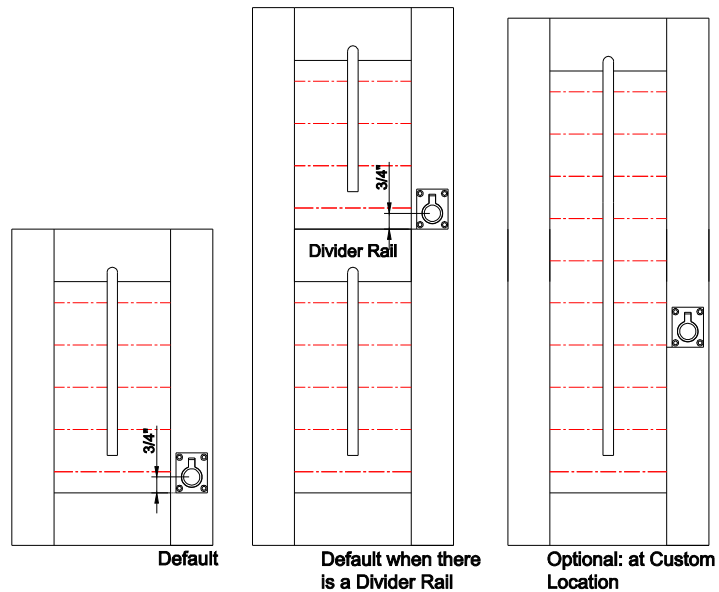

**Position:**

- A. Above Bottom Rail (Default)
- B. Above 1<sup>st</sup> Divider Rail (Default when there are Divider Rails)
- C. Custom Location

If both Panel Lock & ring pull are specified, the distance between them is 2 3/4", and the ring pull location is 6 3/4" from the bottom of panel.

When there is no mid rail, ring pull will be just on the top of Panel Lock (2 3/4" above Panel Lock) as default location; if there are mid rails, bottom of ring pull lines up with top of the 1<sup>st</sup> mid rail as default location.

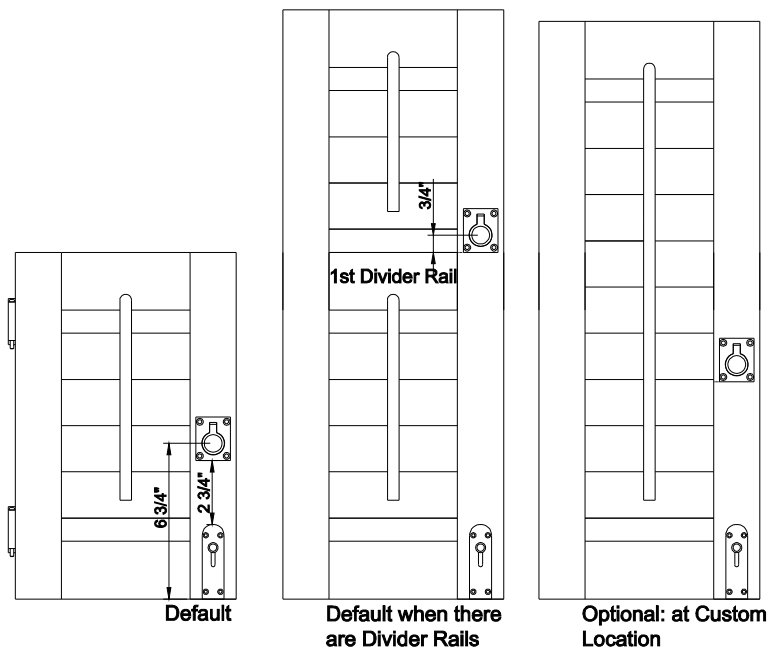

**Position:**

- A. 2 3/4" Above Panel Lock (Default when both Ring Pull and Panel Lock are specified)
- B. Above 1<sup>st</sup> Divider Rail (Default when there are Divider Rails)
- C. Custom Location

**Measurements:**

- Window size:
  - Measure from the bottom of the window to the center of the ring pull.
- Max frame-to-frame:
  - Measure from the bottom of the frame to the center of the ring pull.

**Invisible Hinge**

Frame Options	Hinge	Notes
2" Camber Deco Frame	Y	/
2" Classic Deco Frame	Y	/
3" Ridge Deco Frame	N	/
Vintage L Frame W / 1/4" Light Block	N	/
Vintage L	N	/
Vintage L Frame w/ 1/2" Buildout	N	/
Vintage L Frame w/ 1" Buildout	N	/
Beaded L w 1/4"light block	Y	/
Beaded L	Y	/
Beaded L Frame w/ 1/2" Buildout	Y	/
Beaded L Frame w/ 1" Buildout	Y	/
Bullnose L	N	/
Bullnose L Frame w/ 1/2" Buildout	N	/
Bullnose L Frame w/ 1" Buildout	N	/
Tilt out Z Frame	N	/
1.25" Beaded Z Frame	Y	/
1.5" Bullnose Z Frame	Y	/
2" Bel Air Z Frame	Y	/
3" Crown Z Frame	N	/
7/8" Vintage Hang Strip (31mm) (27mm for 1" stile)	N	/
1" T-Post w/ 1/4" Light Block(for Deco)	Y	only available with hinge on one side, for example, LTL is available, but RTL is not.
1" T-Post w/3/4" Light Block(for L/Z/HS)	Y	
1 3/4" T-Post w/1/4" Light Block(for Deco)	Y	

1 3/4" T-Post w/3/4" Light Block(for L/Z/HS)	Y	
Corner Post w/1/4" Light Block(for Deco)	Y	/
Corner Post w/3/4" Light Block(for L/Z/HS)	Y	/
Bay Post w/1/4" Light Block(for Deco)	Y	/
Bay Post w/3/4" Light Block(for L/Z/HS)	Y	/
Invisible Hinge Qty		
Panel Height (H)	Hinge Qty	
H<=48"	2	
48"<H<=78"	3	
78"<H<=96"	4	
96"<H<=120"	5	
H>120"	6	

Available Stile: Butt and Astragal

Preinstallation:

Panels and frames will be packaged individually, and the hinge is preinstalled onto the frame/post, with the screws for the other half part on the panels in the hardware box.

If bifold/multi-fold panels are packaged together, the hinges are installed before shipping, or the hinges & screws are packed into the hardware box.



**Side Magnet: Available for Butt, rabbet and Astragal stile**



Side Magnets will be applied in following situation:

1. Double Hung shutter but without horizontal T post:

Side magnets will be applied to the meeting stiles of the L and R panel. (Default)

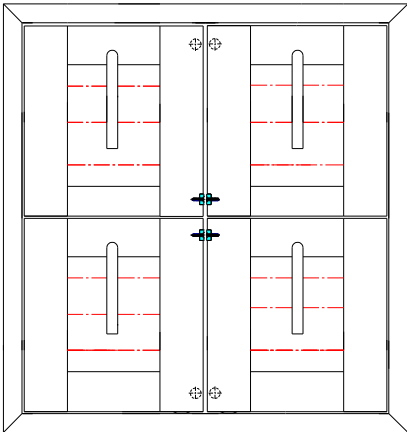

2. Café Shutter

Side magnets will be applied to the meeting stiles of the L and R panel. (Default)

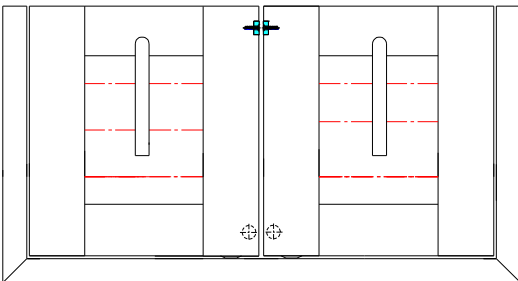

3. No frame or light block or L-shape striker plate on either top or bottom, or if larger than standard top or bottom gap is requested.

Side magnets will be applied to the meeting stiles of the L and R panel. (Optional)

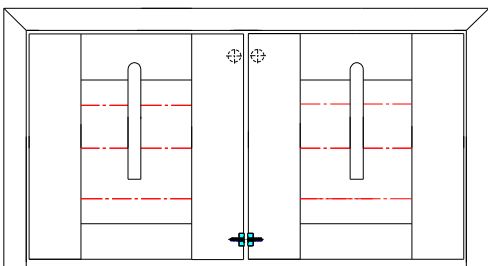

# Bi-fold 180™

## Guidelines and Specs:

<u>Description</u>	<u>Minimum</u>	<u>Maximum</u>
		2½" ; 3½" ; 4½"
Single-Panel Width (Bi-fold Track)	6"	26"
Single-Panel Width (LLL/RRR)	6"	20"
Single-Panel Height	10"	133"

### Outside Mount

Max frame-to-frame width: window width + 3 1/2"

Max frame-to-frame height: window height + 4 1/2"

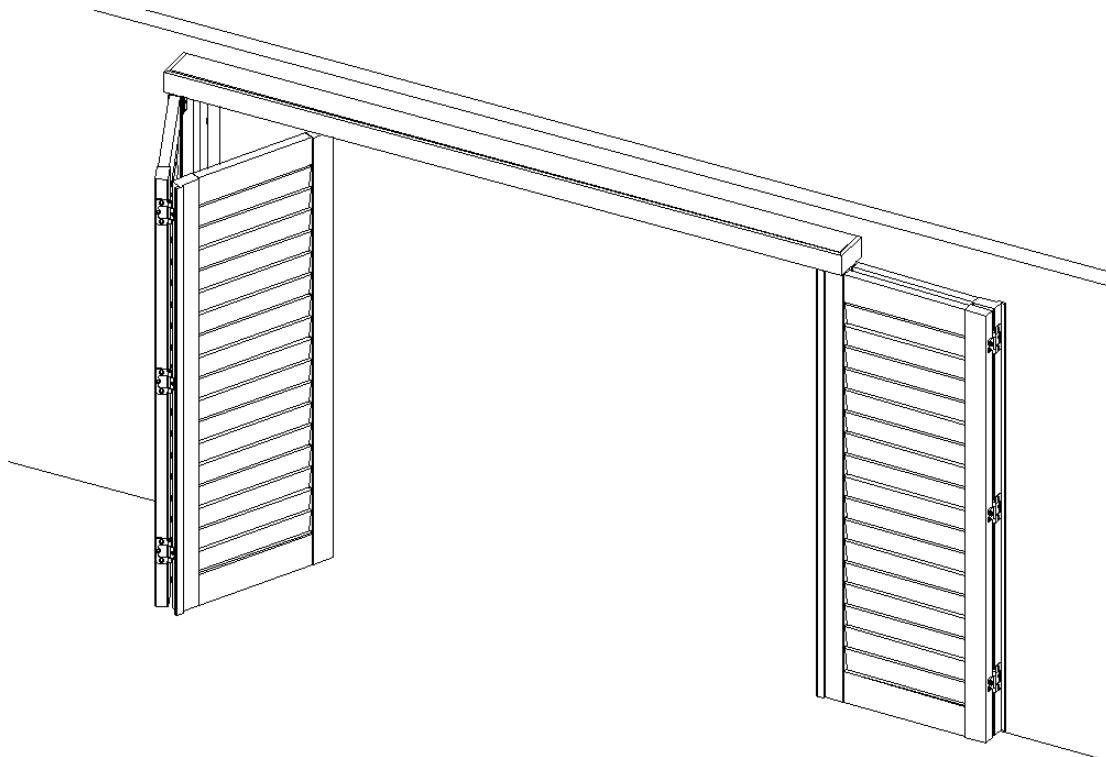

- Track is pre-installed on the header; standard 1 track only.

**Mounting Options: Outside Mount only**

**Side View**

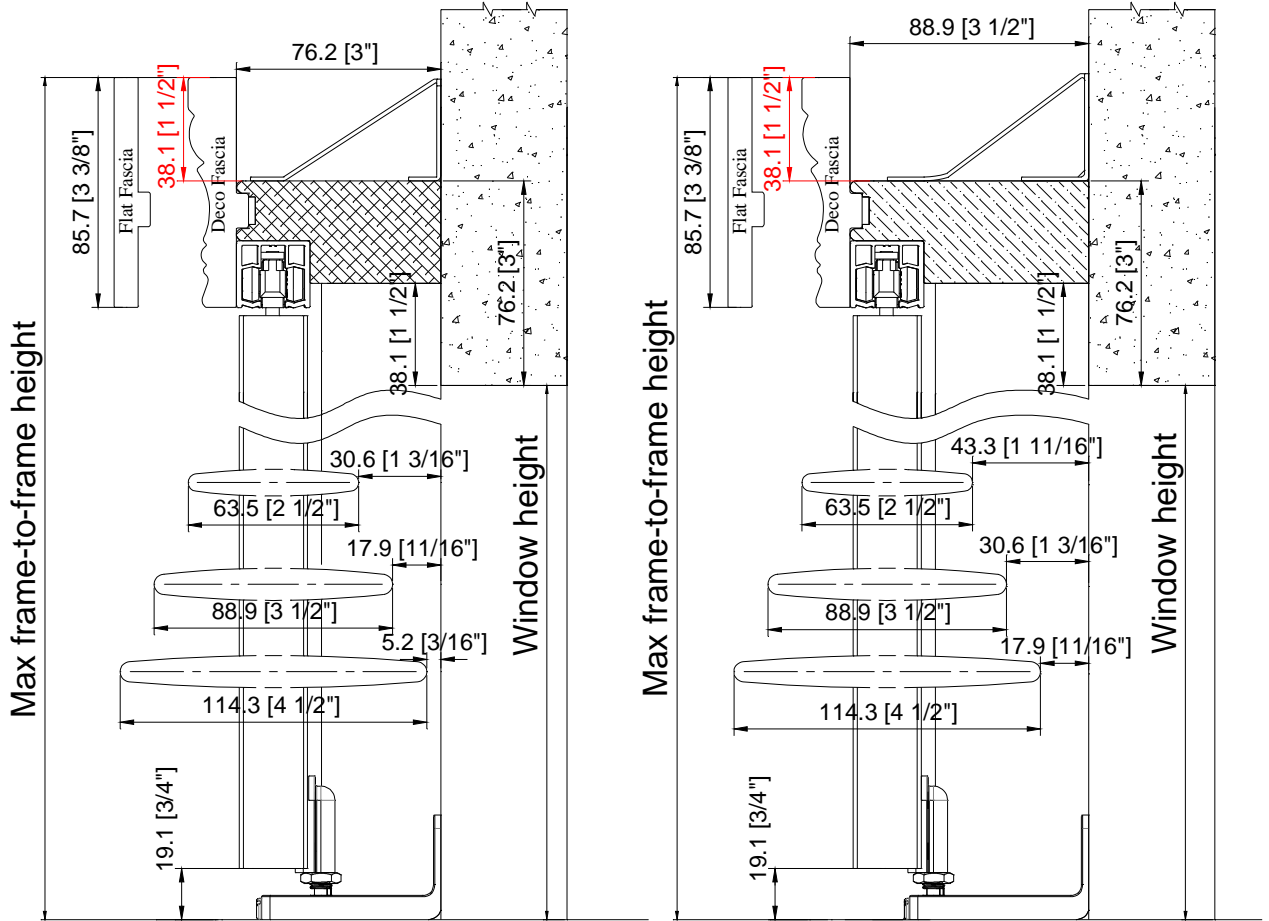

**Top View**

**Without Casing:**

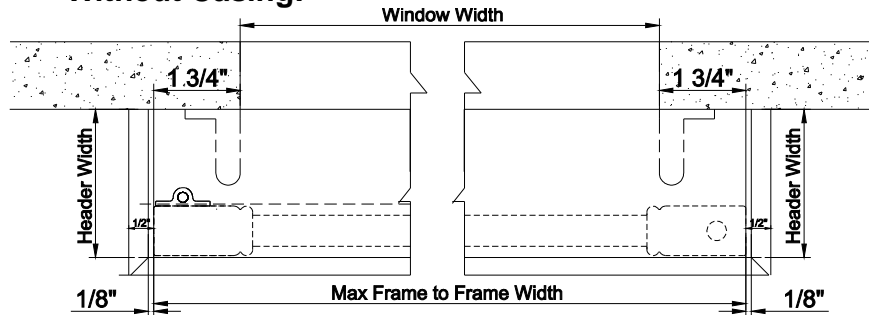

Note:

◇ Fascia return will protrude the panel about 1/2" for each side.

◇ The header will protrude the panel about 1/8" for each side.

◇ Header, light blocks, and bottom pivot bracket(s) must be installed on a flat surface.

## With Existing Casing:

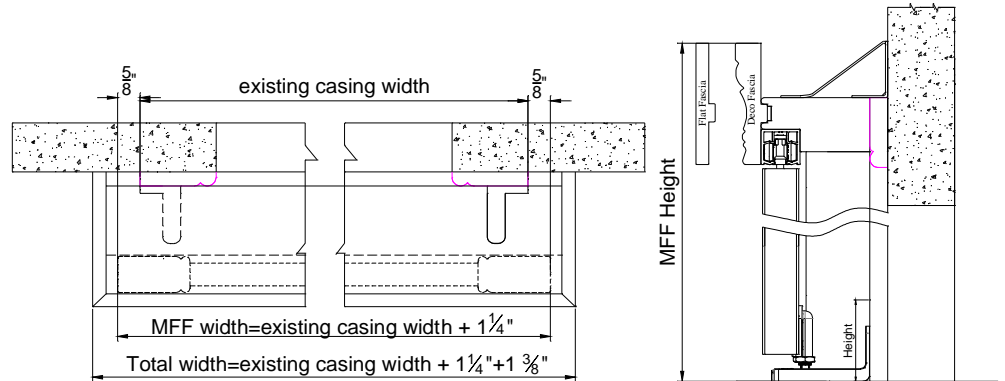

- ✧ Header Extension: Optional
- ✧ Custom extension up to 2" for Header
- ✧ When extension is needed, the header will protrude the panel 5/16" for each side and the fascia return will protrude the panel 11/16" for each side.

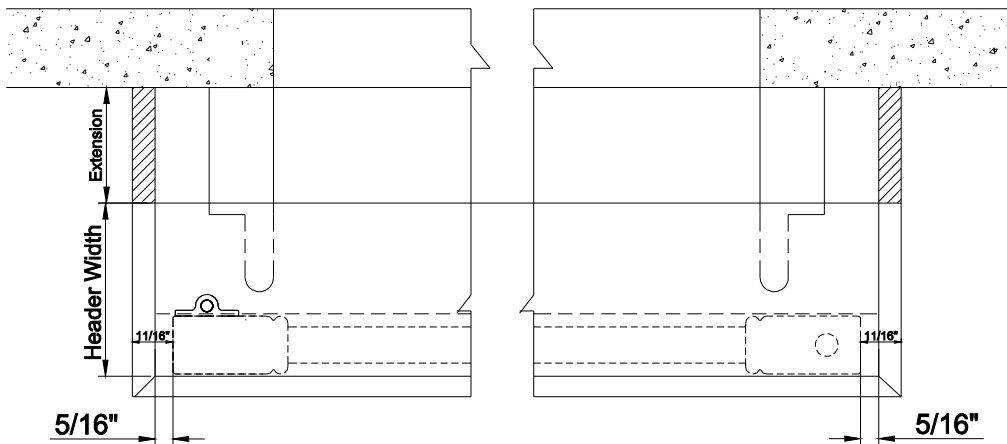

- ✧ The extension will be pre-attached.

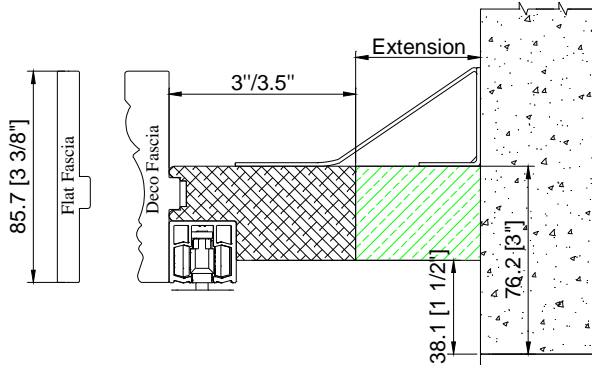

# *Normandy Shutters*

For 180 Bi-fold, if Bottom Pivot L Bracket is required, the extension for the L shape light block will be  $1\frac{3}{4}$ " in width. Please see picture below:

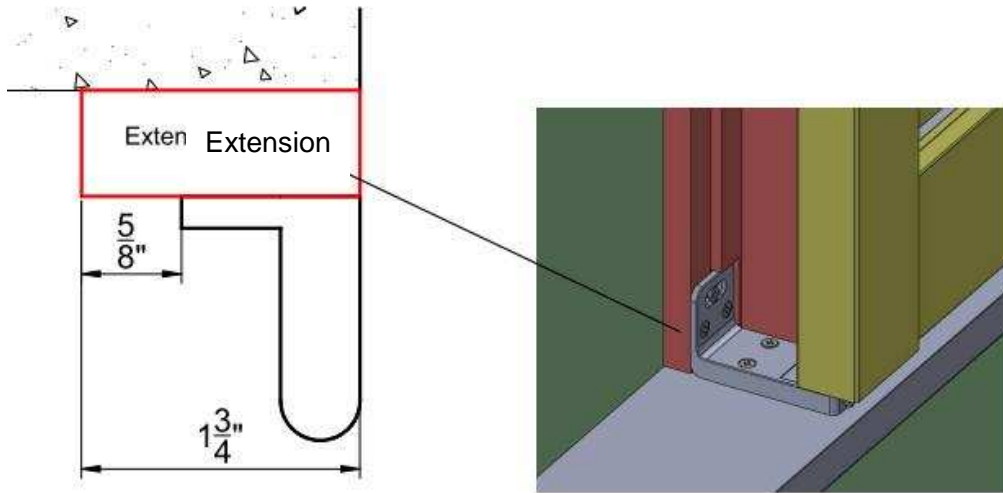

**Panel Configuration : Only 2", 2 1/4" rabbet and butt stiles are available. Center stile is not available.**

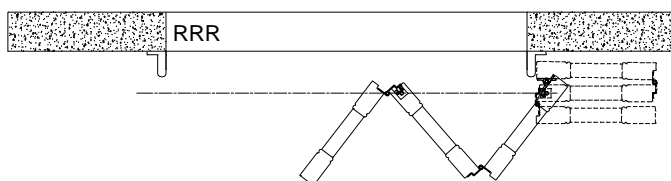
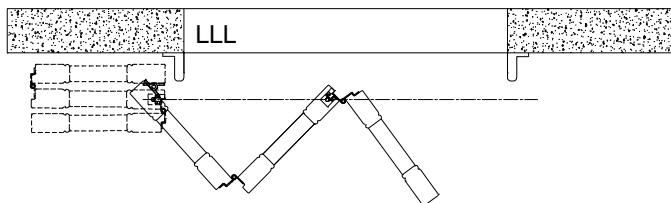
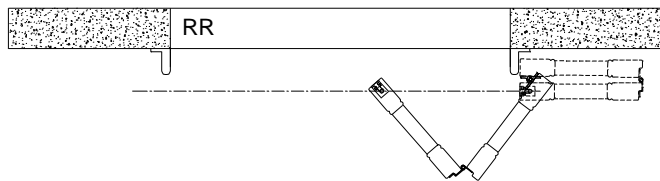
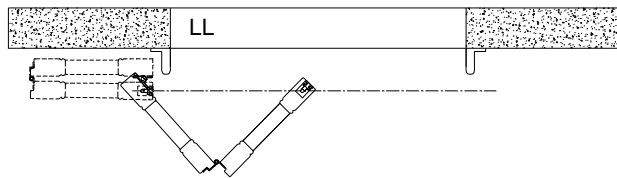
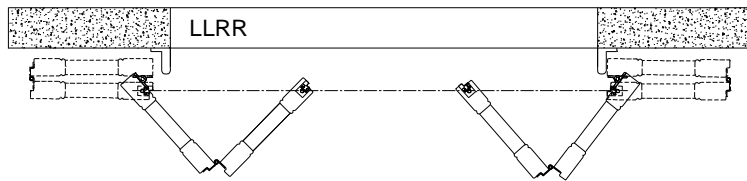
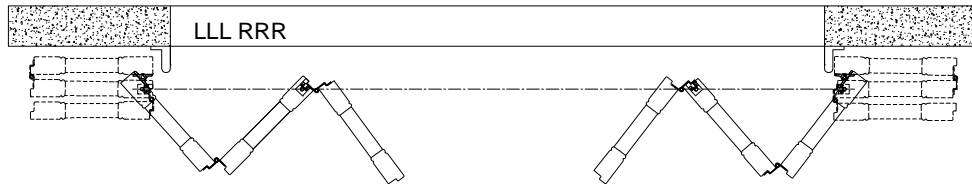

**Notes:**

If there is no baseboard to the wall, 3" header can be used.

If there is baseboard to the wall, then it should be as below:

1. If base board thickness is less or equal to 5/8", 3 1/2" header can be used.
2. If base board thickness is over 5/8", it is suggest using the 3" header with build out. And the build out thickness=base board thickness-1/8".

Please see the drawing below:

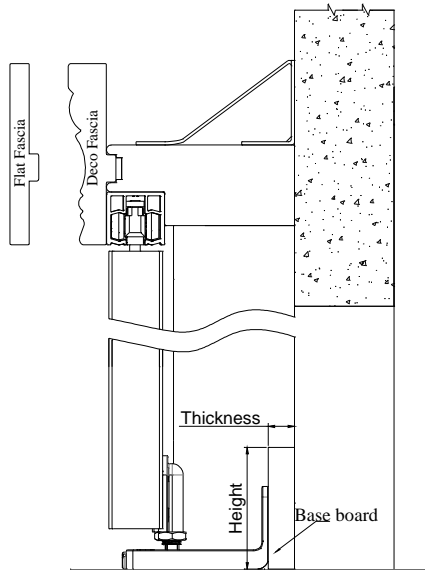

**180° Bi-fold Track Shutters Framing Materials**

Type	Header Dimension	Top Fascia Dimension	L Shape Light Block Strip Dimension
Header & Top Fascia & Light Block Strip	3"	3 3/8"	1 9/16"
	3 1/2"		2 1/16"

**180° Bi-fold Track Shutters Hardware Box**

<b>Parts</b>
Wrench
Hinge Pin
Support L Bracket (based on the length of header)
2 ½ " screws for support L bracket
¾ " screws for support L bracket
Bottom Pivot Bracket
1 ½ " screws for bottom pivot bracket
2 ½ " screws for Frame with pre-drilled screw holes



## Bi-fold 90

### Guidelines and Specs:

<u>Description</u>	<u>Minimum</u>	<u>Maximum</u>
		2½" ; 3½" ; 4½"
Single-Panel Width (Bi-fold Track)	6"	26"
Single-Panel Width (Multifold track up to 4 panels)	6"	20"
Single-Panel Height	10"	133"

#### Outside Mount

Max frame-to-frame width: window width + 3 1/2"

Max frame-to-frame height: window height + 4 1/2"

#### Semi-Inside Mount

Max frame-to-frame width: window width - 1/8"

Max frame-to-frame height: window height + 1 3/8"

#### Inside Mount

Max frame-to-frame width: window width - 1/8"

Max frame-to-frame height: window height - 1/8"

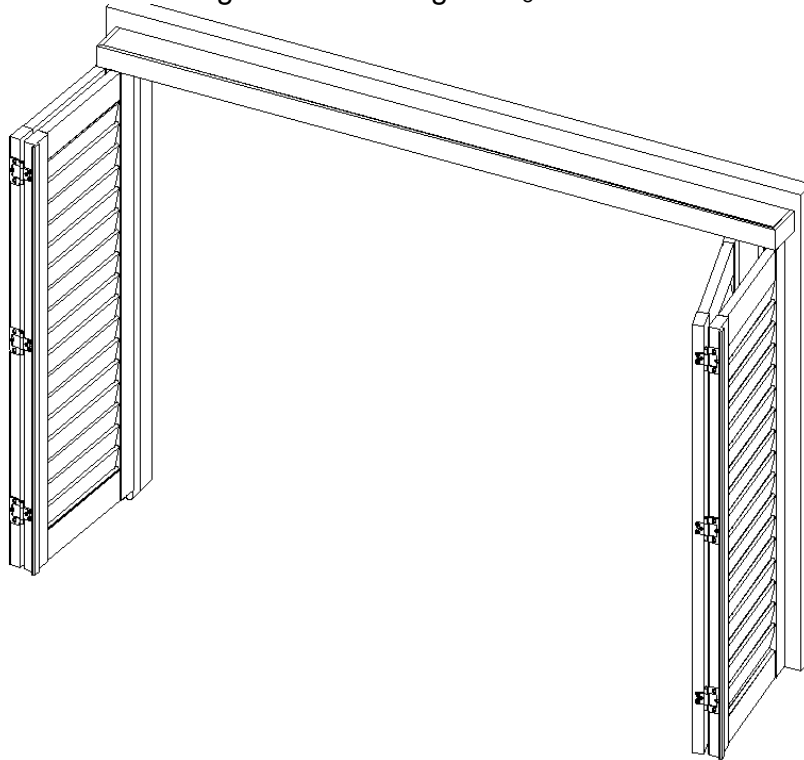

Track is pre-installed on the header; standard 1 track only.

**Mounting Options: Outside Mount**

**Side View**

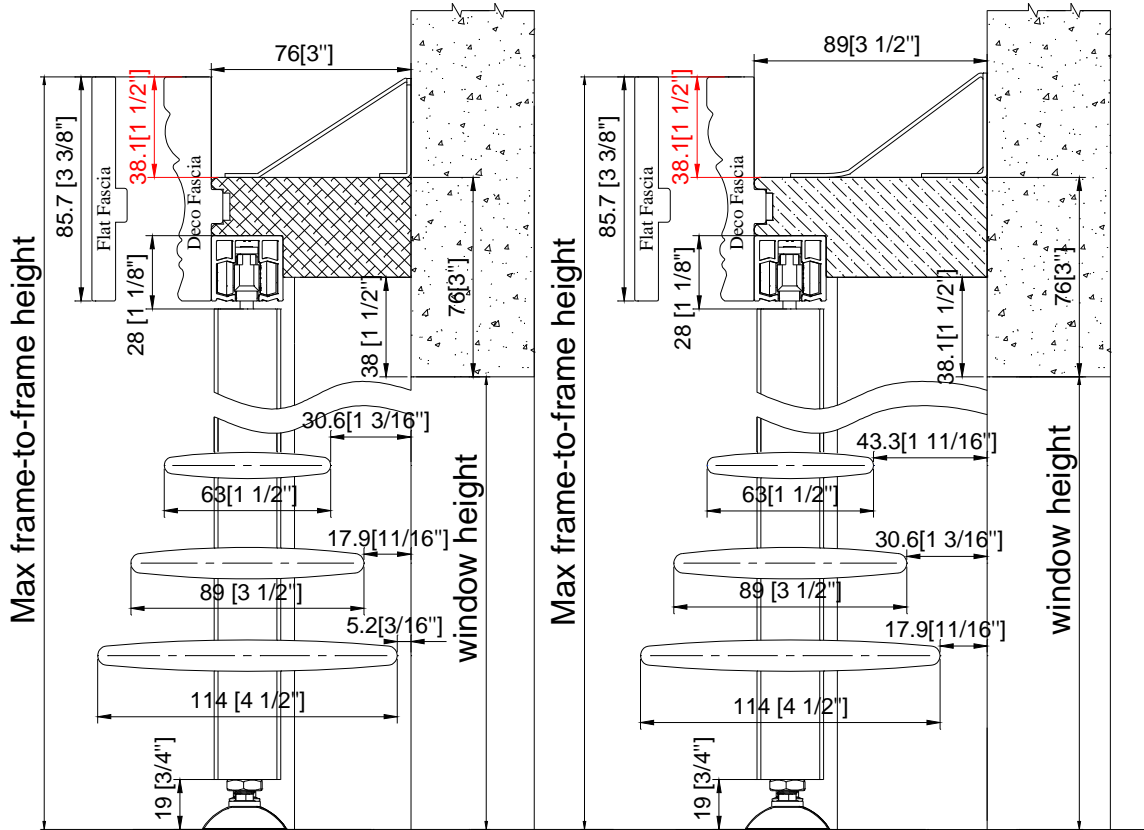

**Top View**

**Without Casing:**

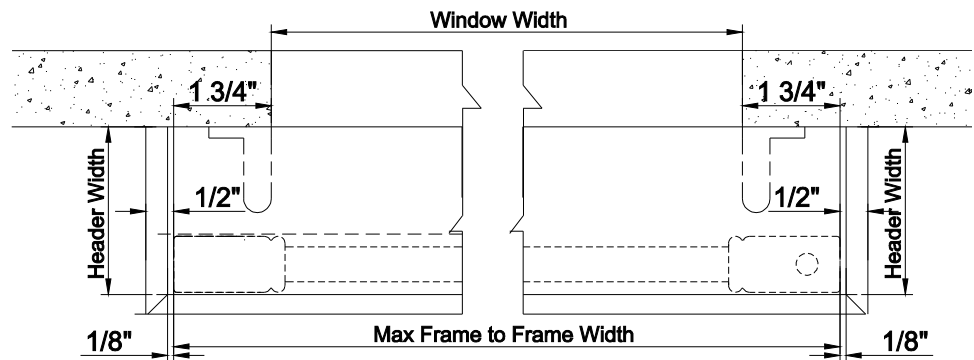

Note:

- ◇ Fascia return will protrude the panel about 1/2" for each side.
- ◇ The header will protrude the panel about 1/8" for each side.
- ◇ Header, light blocks, and bottom pivot bracket(s) must

## With Existing Casing:

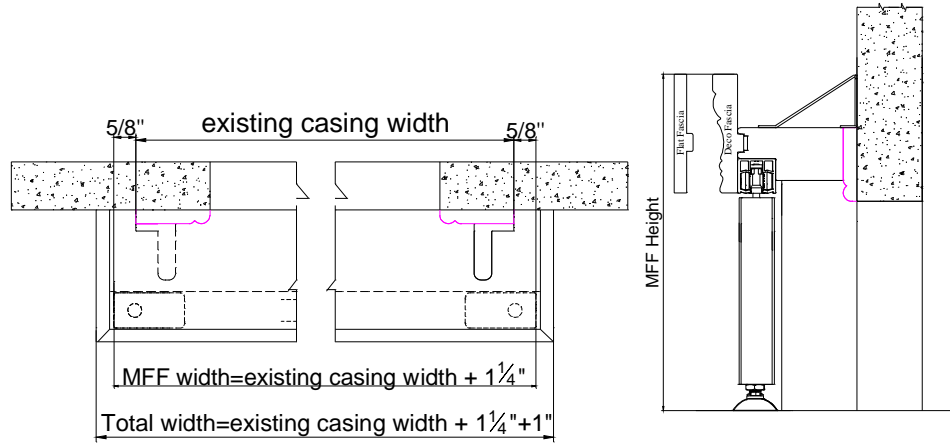

## Semi-Inside/Inside Mount

### Side View

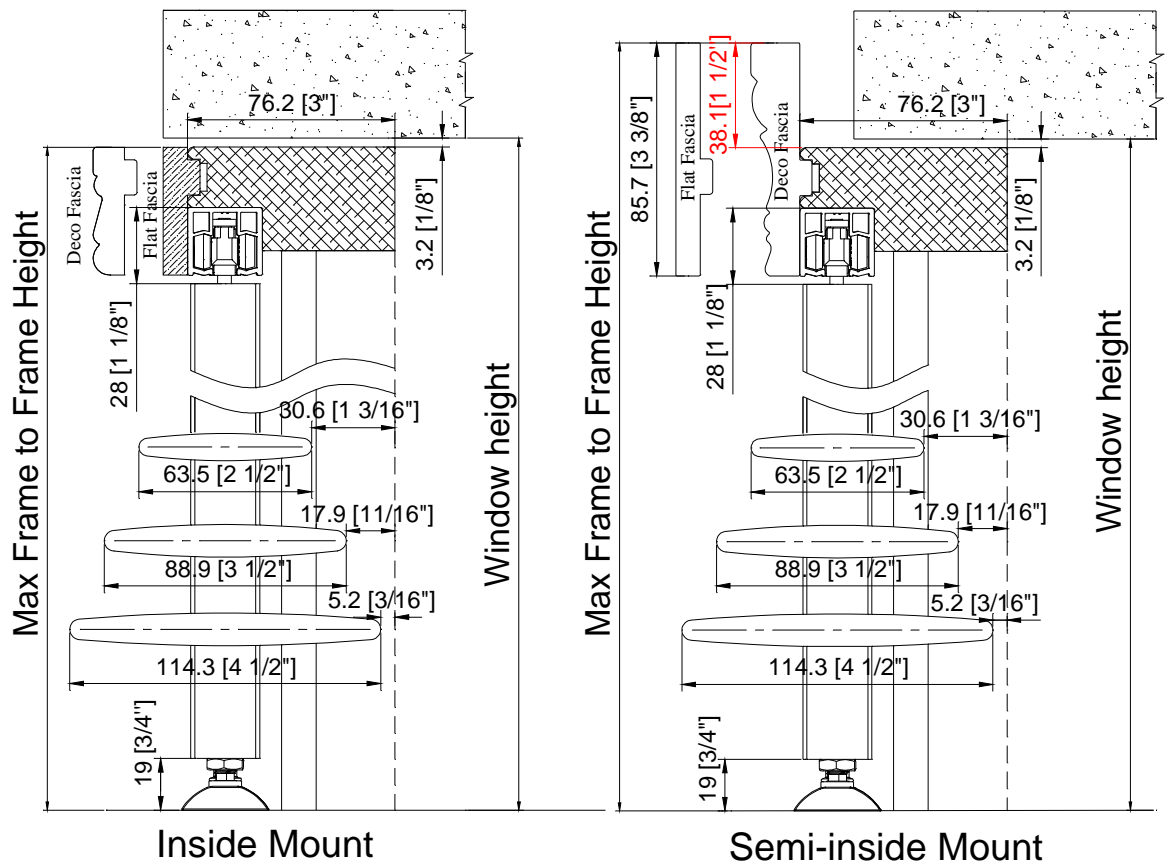

Semi-Inside Mount Top View

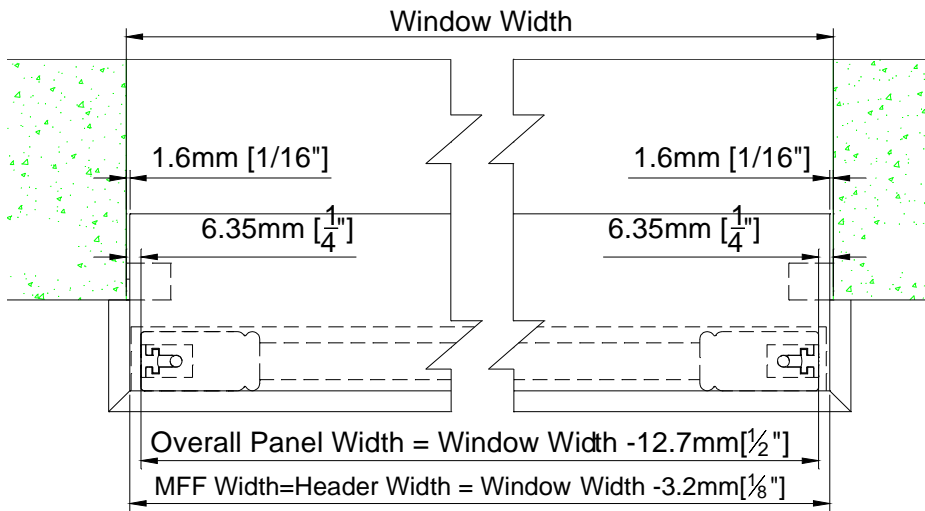

Inside Mount Top View

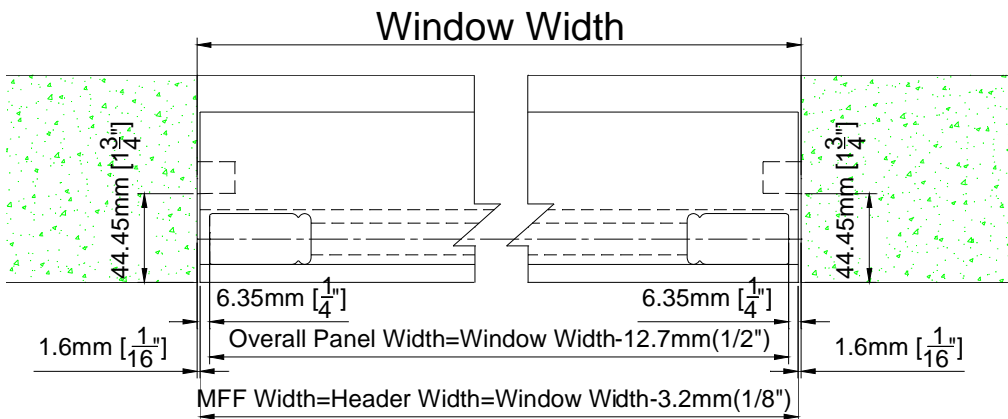

- ✧ Header Extension: Optional.
- ✧ Custom extension up to 2" for Header
- ✧ The extension will be pre-attached.

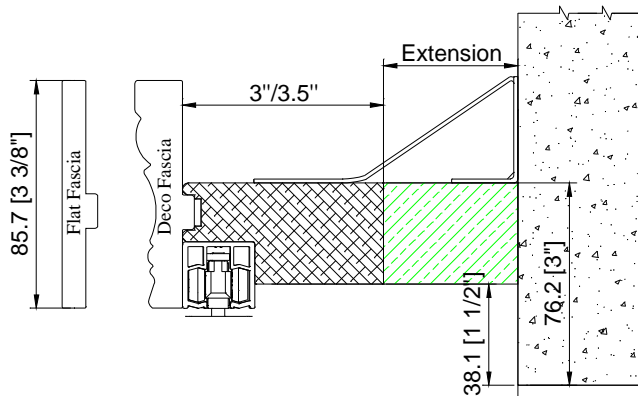

**Panel Configuration : Only 2", 2 1/4" rabbet and butt stile are available. Center stile is not available.**

LL or RR

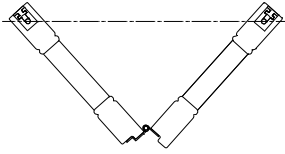

LLRR

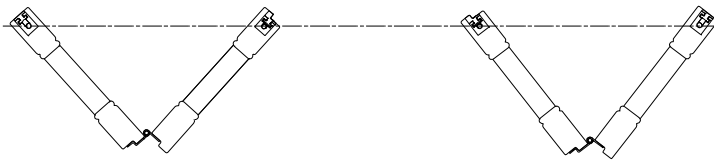

**Optional (Hang Strip for Inside Mount Only)**

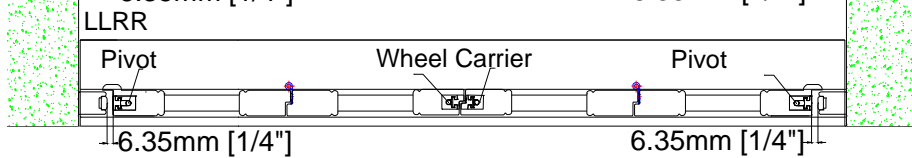
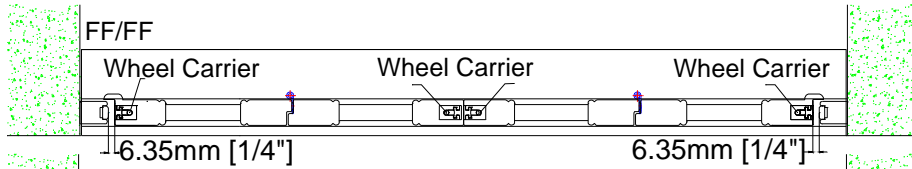
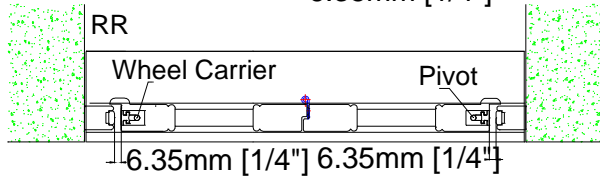
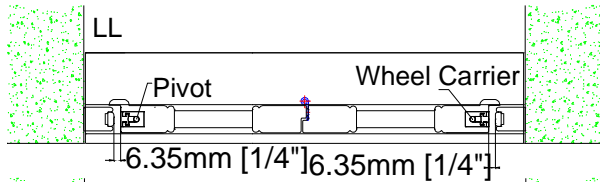

Note: When Butt/rabbet Stile is required, the stile next to the hang strip will be astragal stile.

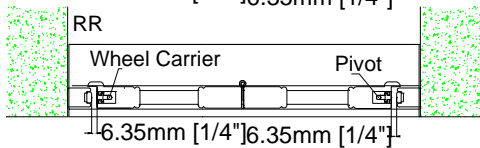
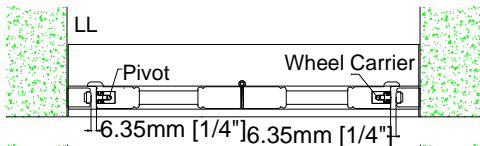

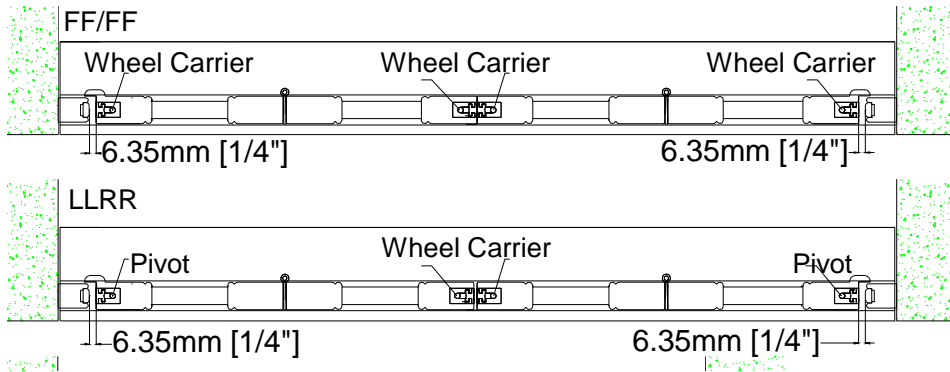

**90° Multi-Fold Track Shutters (Wood only)**

Maximum single panel width for multi-fold is 20"  
Panel Configuration: LLLL, RRRR, or LLLLRRRR

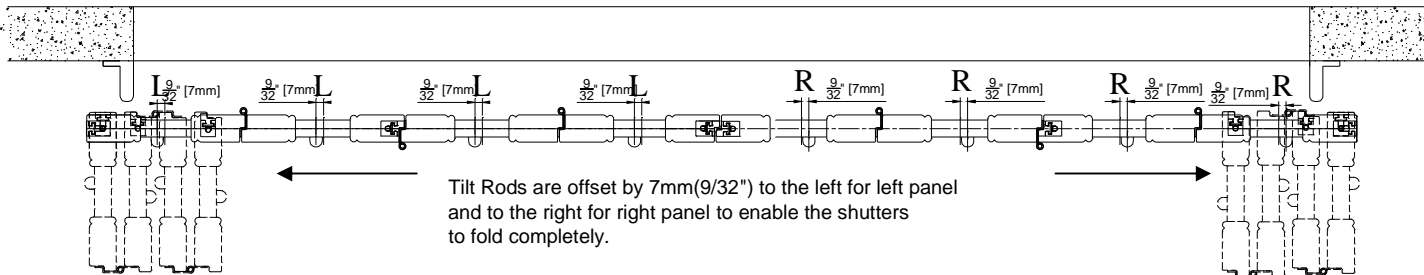

**90° Floating Panels**

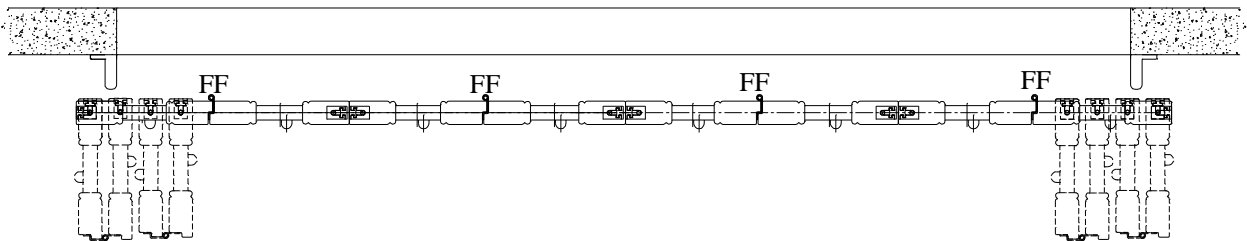

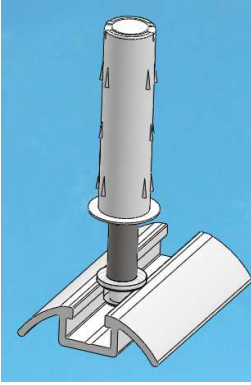

- Two or four panels can be hinged together, fold and slide to either direction
- Application comes with wheel carrier, spring loaded guide and floor track
- Can be used on large window

1. For 90° Floating Panels outside mount/semi-inside mount without the side boards, T-Stopper will be supplied and the gap between the fascia return and the panel is 11mm each side. Please see drawing below to show the gap.

2. When rabet stile required, the meeting stile of unhinged stile will be butt stile by default.

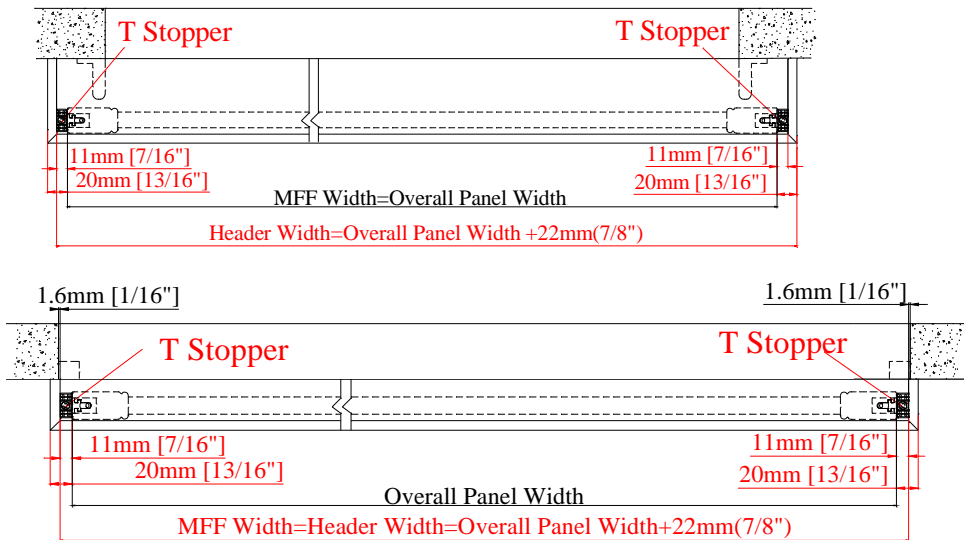

**90 Degree Bi Fold Track Shutters Framing Materials**

Type		Header Dimension	Top Fascia Dimension	Light Block Strip Dimension	Hang Strip Dimension
Header & Top Fascia & Light Block Strip	OM	3"	3 3/8"	1 9/16"	1.08"x0.875"
		3 1/2"		2 1/16"	
	Semi-IM	3"	5/8"x3/4"		
	IM	3"	1 7/8"	5/8"x3/4"	

Note: It will be L shape light block strip for outside mount.

**Frame Hinged Bifold**

**Available Stile: Rabbet Stile Only**  
**Available Frame type**

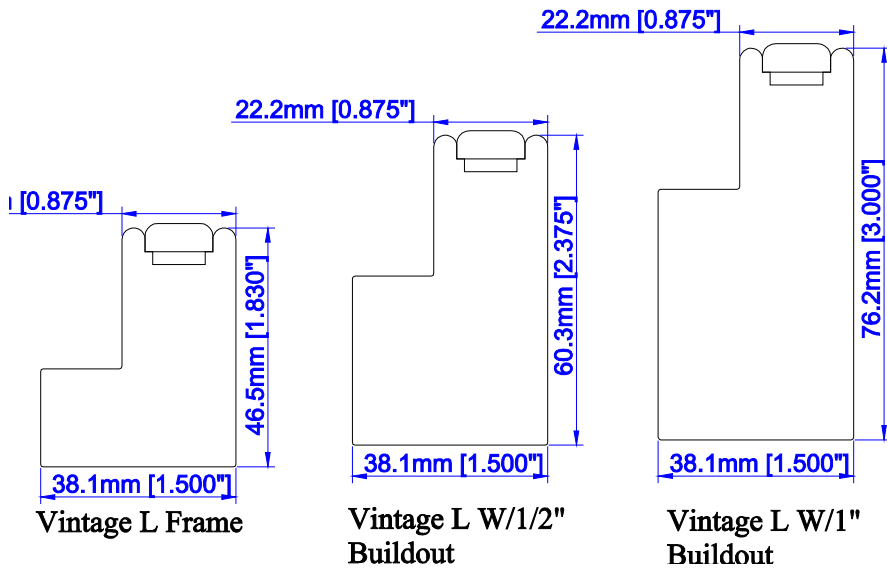

**Vintage Hang Strip with 11.5mm light block:** For single direction bi-fold or multi-fold shutter with even panel qty, the frame on the unhinged side will be Vintage Hang Strip with 11.5mm [0.453"] light block, the height of the Vintage Hang Strip will match with that of the hinged side frame.

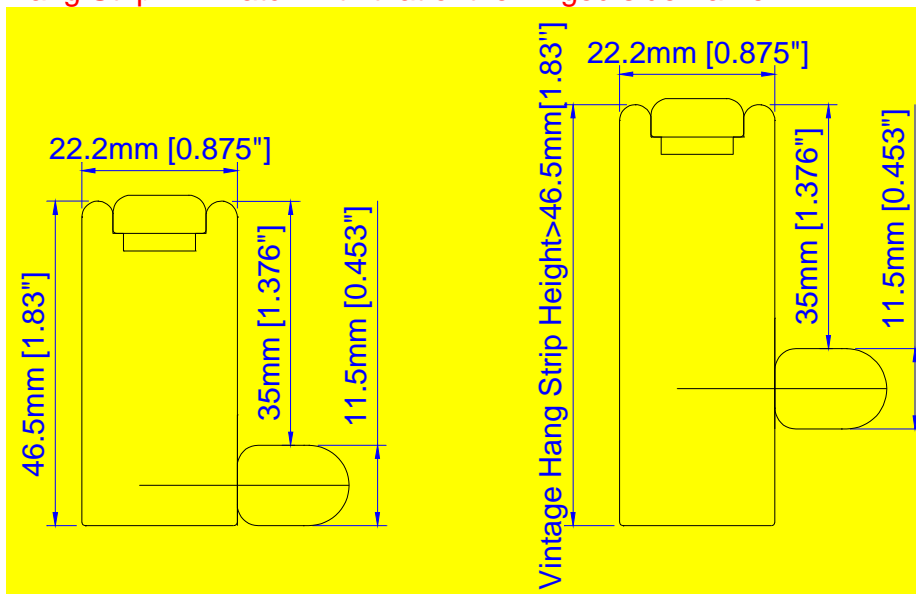



**Top View**

Hinged at Left or Right with wheel assembly at top;

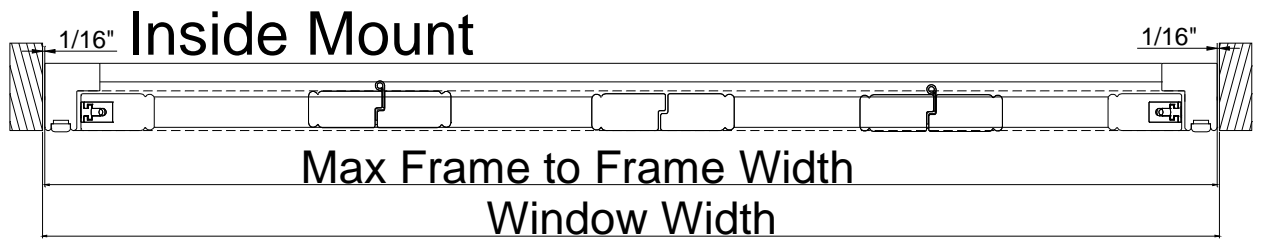
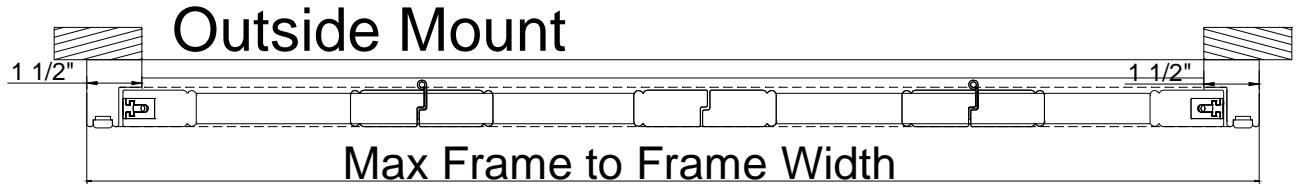

**Side View**

Outside Mount

3-Sides + bottom light block

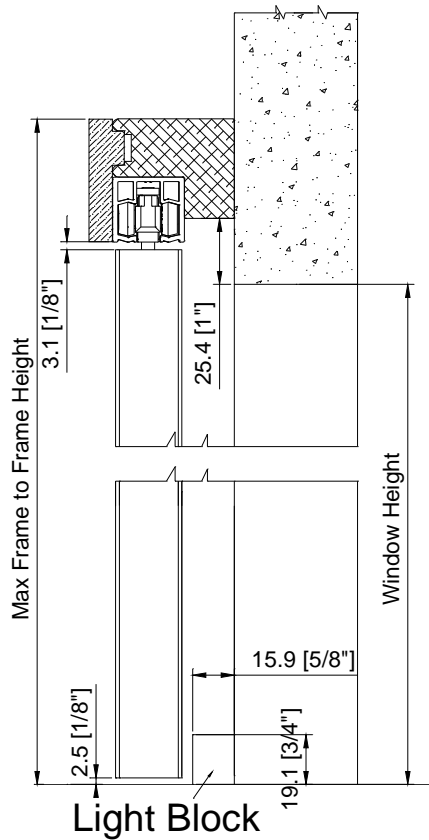

3-Sides + 3" Deco Sill Frame

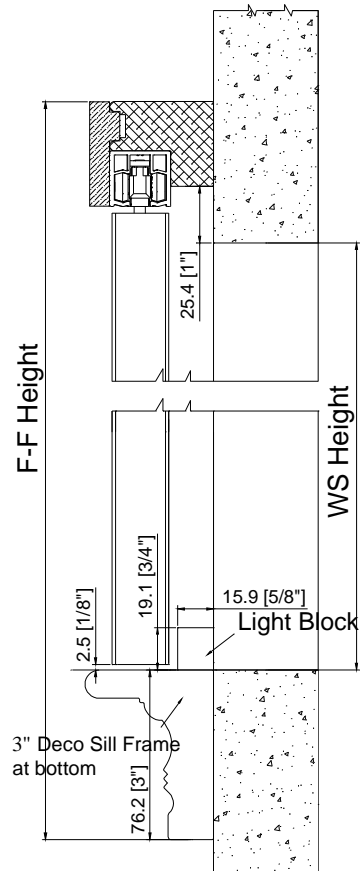

# Normandy® Shutters

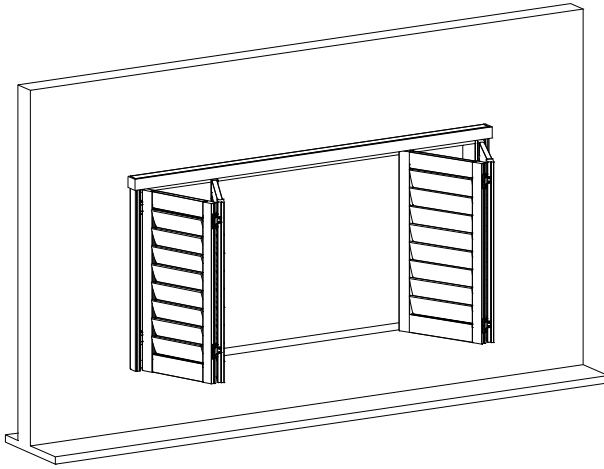

Note: For OM Frame Hinged Bifold shutter not to use as a door, if there is no existing sill at the bottom of the window opening, it is recommended to have the 3" Deco Sill Frame at the bottom.

Semi-Inside

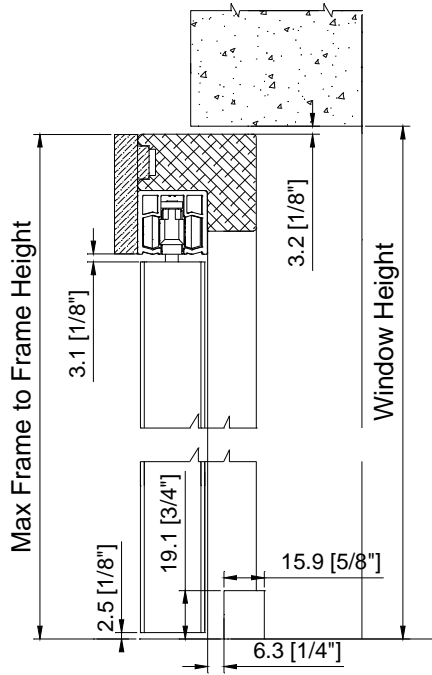

Inside Mount

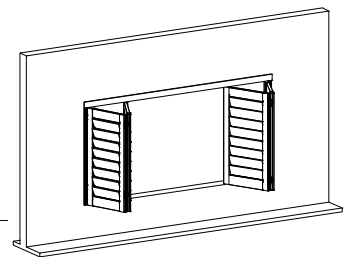
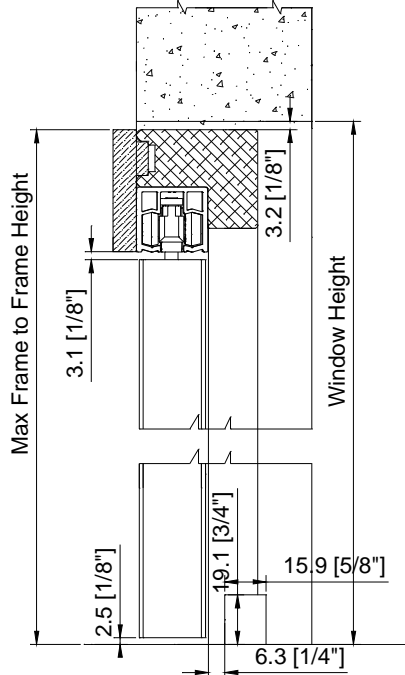

For frame hinged bifold track shutter used as door, the bottom gap will be 19mm by default. Please specify "Used As Door" on the order form.

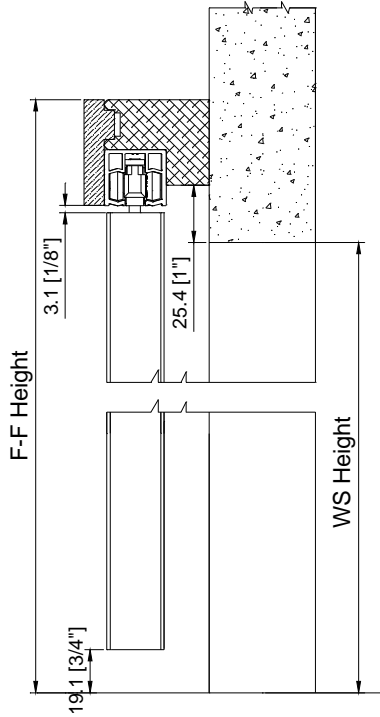

**Panel Configuration (uneven panel width)**

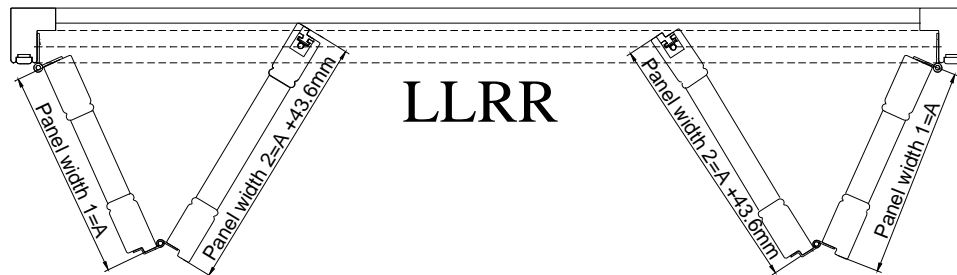
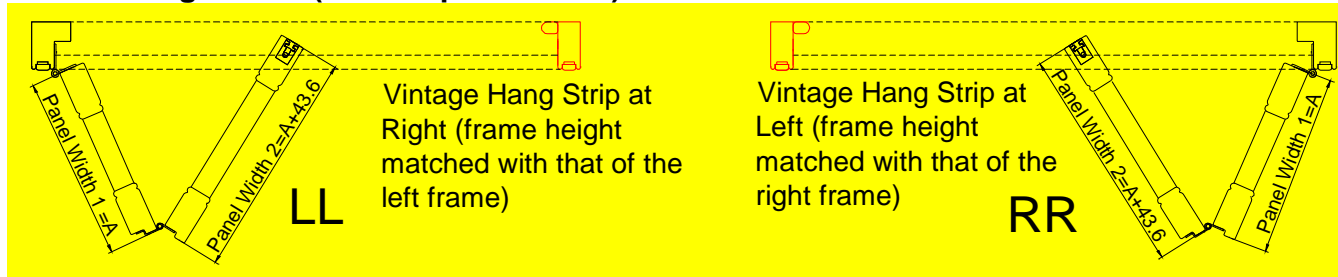

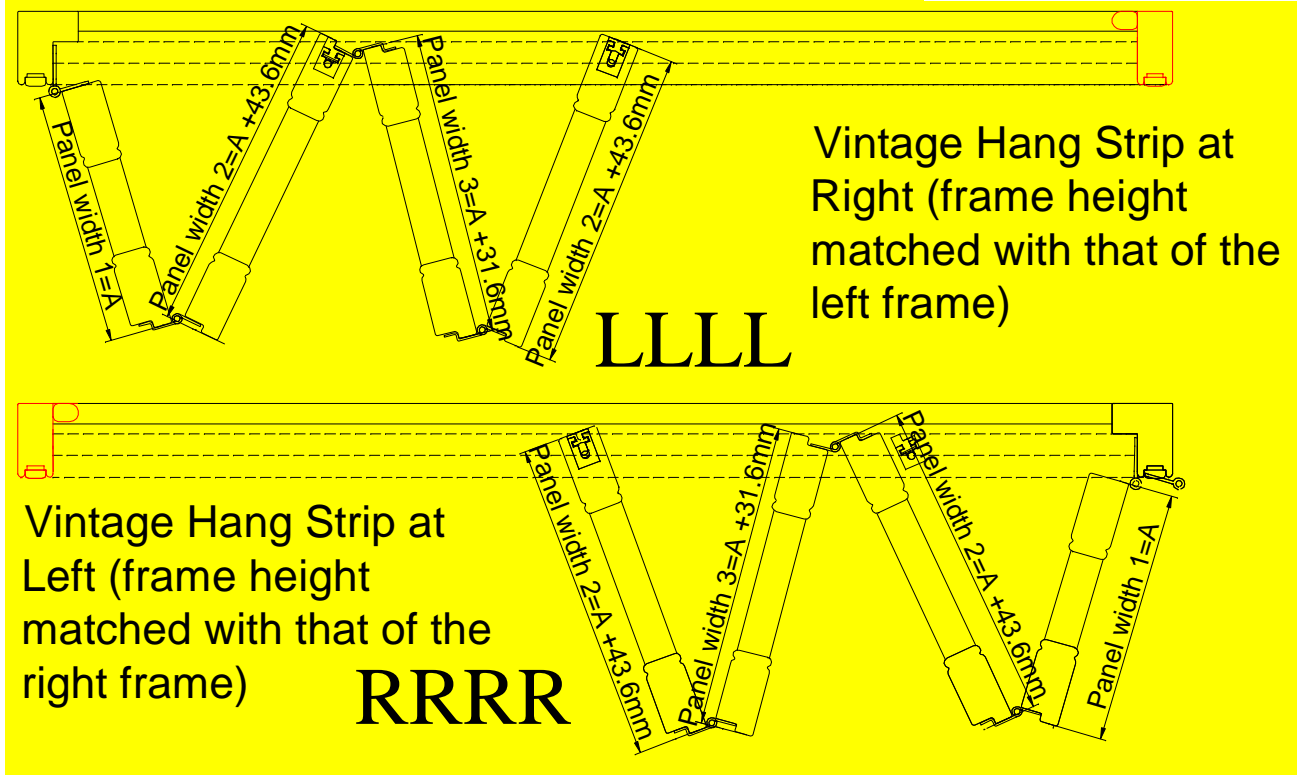
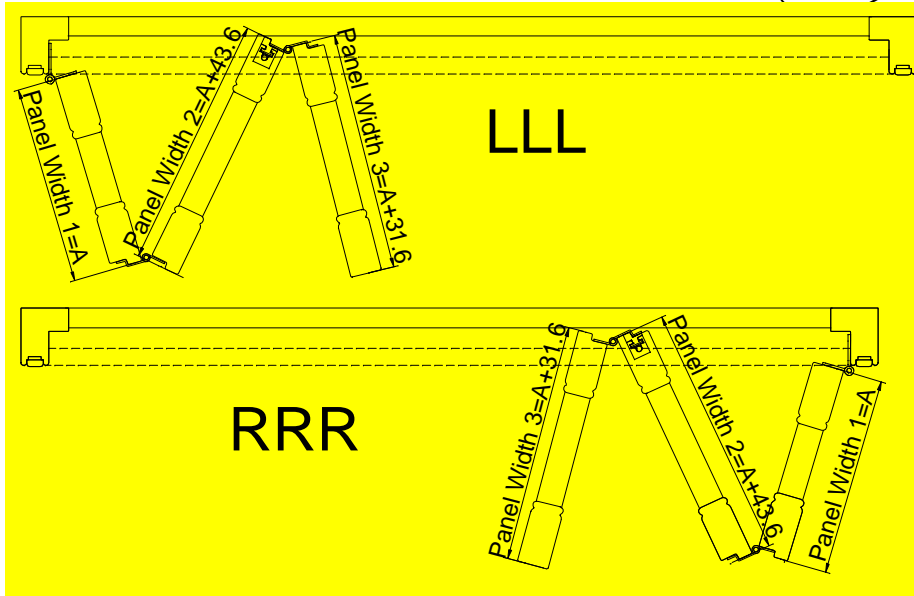

# Normandy Shutters

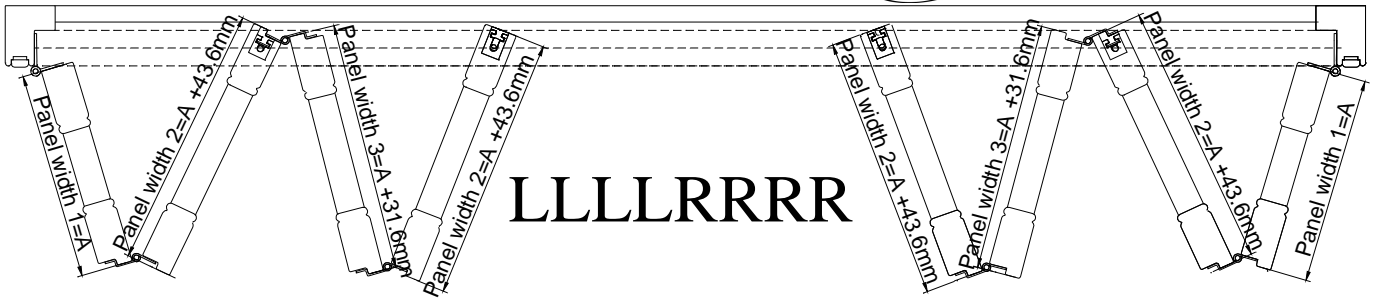

## Notes:

1. Only available for 3-Sides + bottom light block or 3-Sides + 3" Deco Sill Frame (4-sides is not available); Panels can be folded and open at 100 degree;

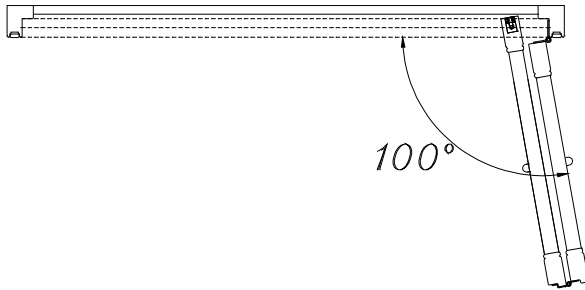

2. Frames available: Only Vintage L Frame

- 1) For top frame, the insert will be replaced by top fascia;
- 2) Top track will be pre-attached to the top frame;
- 3) Frame will be pre-drilled with screw holes same as regular shutters.

**Ring Pull:** The ring pull will be provided as an option. Customer need specify ring pull location on the order form. Ring pull location is measured from the floor to center of the ring pull in height direction. Ring pull color will match the hinge color.

# Normandy® Shutters

Please refer to below drawing of ring pull position for all shutter types:

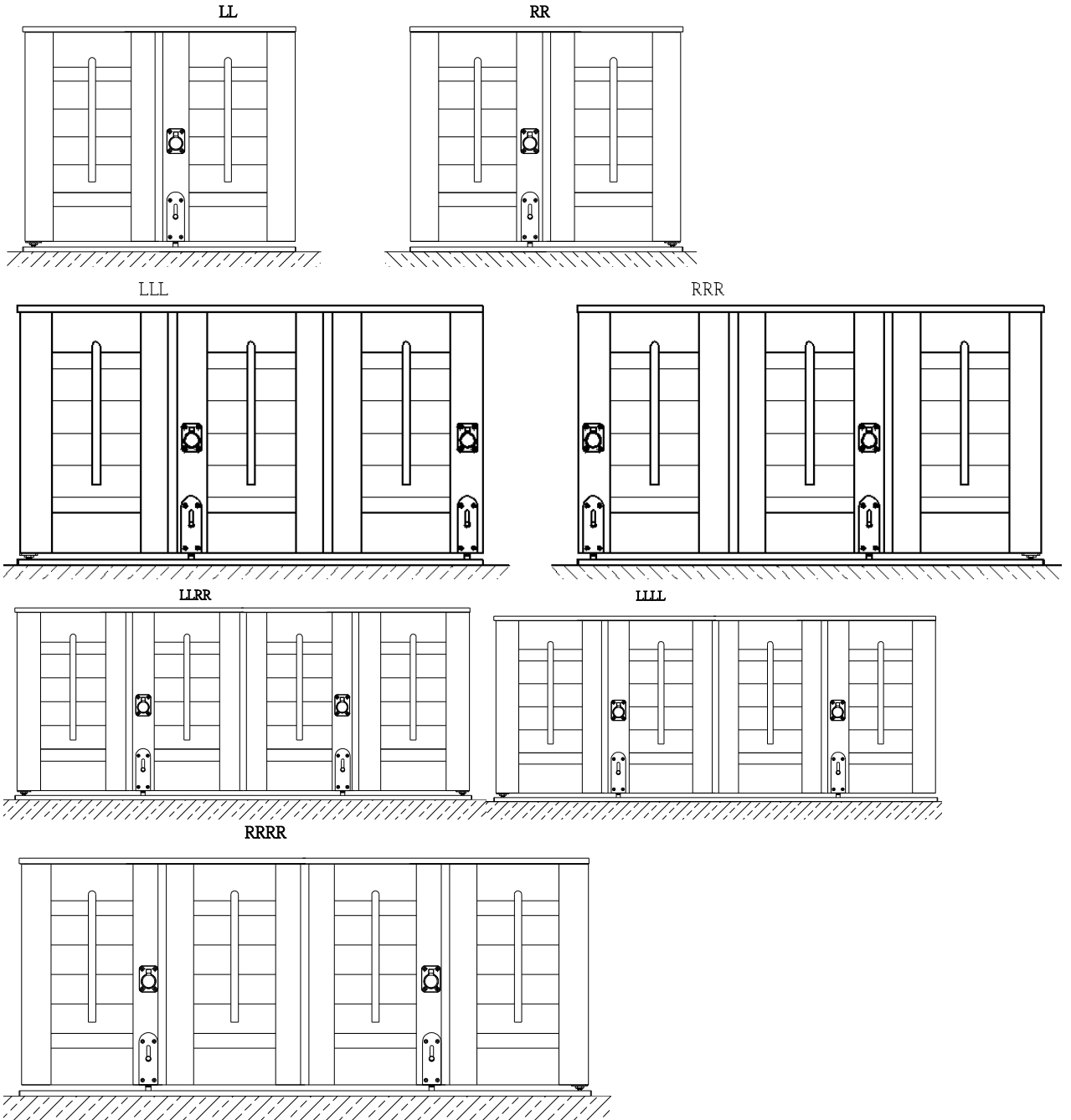

**Bottom Pivot Bracket for 90 degree bifold:**

For 90° Bifold Track Shutter, there will be 2 types of Bottom Pivot Brackets available.

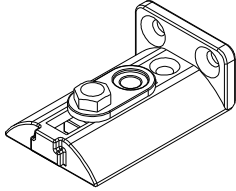

For Inside Mount, Bottom Pivot L Bracket will be supplied as default;

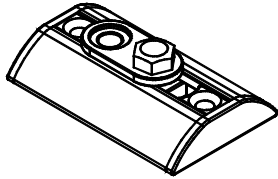

For Semi-Inside or Outside Mount, bottom pivot bracket will be supplied as default.

**Track Dimension:**

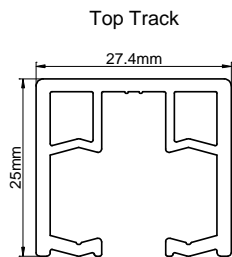

**Extra Magnets will be supplied for Bifold hinges: (only for the most top and bottom hinges)**

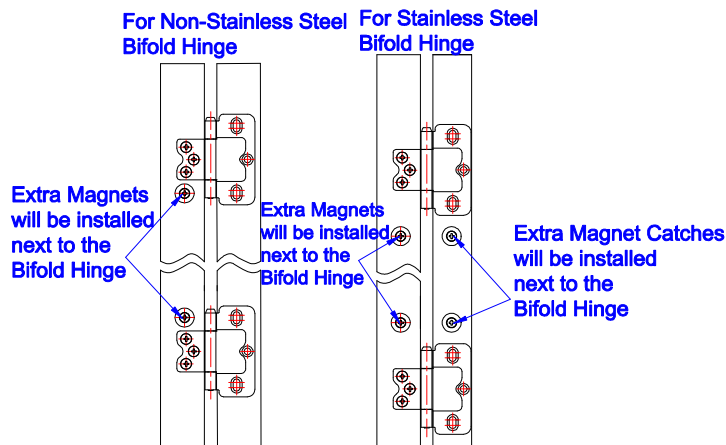

**Side Magnet:** applied to the meeting stiles of LR panels

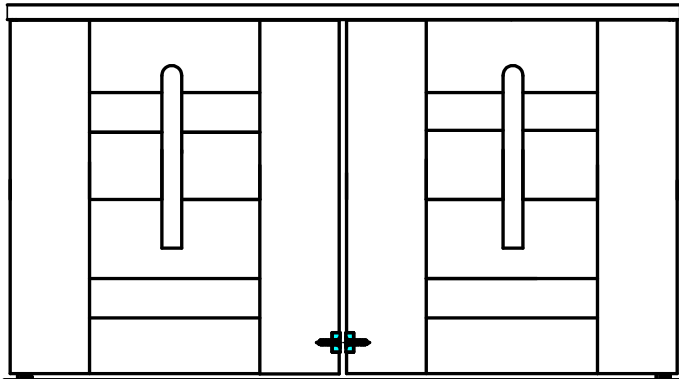

**Extra magnet and Side Magnet**



### 90° Bi Fold Track Shutters Hardware Box

Parts
Wrench
Hinge Pin
Support L Bracket (based on the length of header)
2 ½ " screws for support L bracket
¾ " screws for support L bracket
Bottom Pivot Bracket
38.1mm screws for bottom pivot bracket
63.5mm screws for Frame with pre-drilled screw holes

**Notes:**

1. for all bifold track shutter Outside Mount, the header will be pre-drilled with screw holes in the insert and screws will be supplied by default;



# *Normandy Shutters*

2. for all bifold track shutter Inside/Semi-Inside Mount, the header will be pre-drilled with holes for screws and wood plug and screws and wood plug will be supplied by default

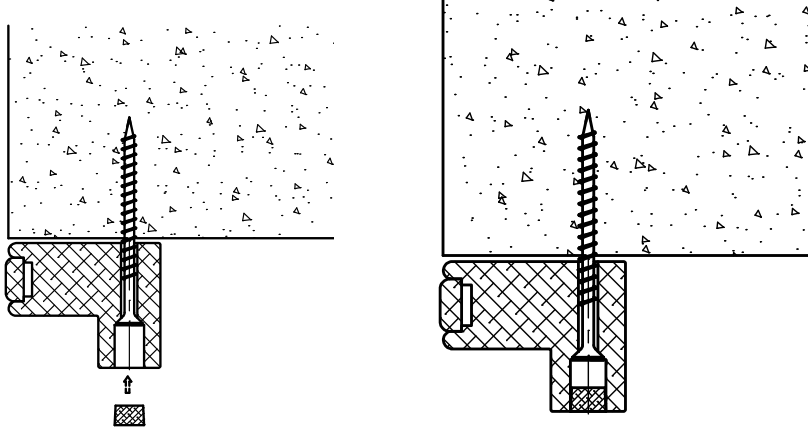

# 2016 Track Shutters—Bypass



## Guidelines and Specs:

<u>Description</u>	<u>Minimum</u>	<u>Maximum</u>	
		2½"	3½" ; 4½"
Single-Panel Width (Wood)	6"	36"	42"
Single-Panel Height	10"	133"	133"

### Outside Mount

Max frame-to-frame width: window width + 3"

Max frame-to-frame height: window height + 4½"

### Semi-Inside Mount

Max frame-to-frame width: window width - 1/8"

Max frame-to-frame height: window height + 1 3/8"

### Inside Mount

Max frame-to-frame width: window width - 1/8"

Max frame-to-frame height: window height - 1/8"

### **Carriers are in the Track / Hangers are in the Panel:**

Adjustments to panel alignment are made by turning the Carrier Bolt with the wrench included in the Hardware Box

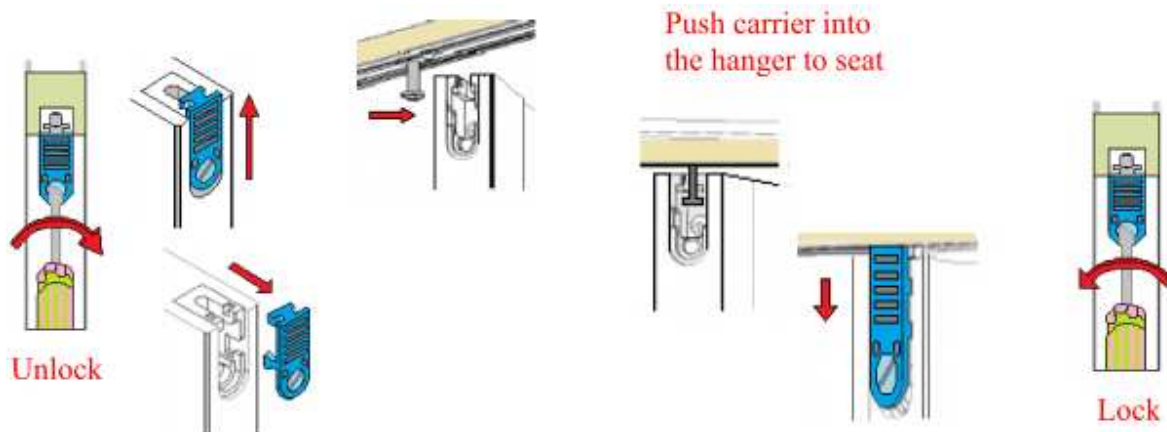

# 2016 Track Shutters—Bypass



## Top View

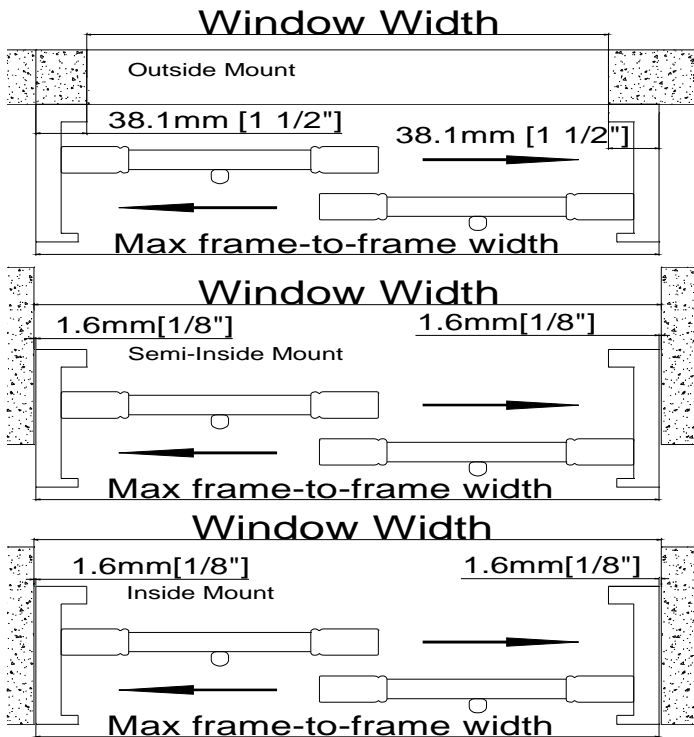

## Size Definition

### For Semi-Inside/OM without side boards

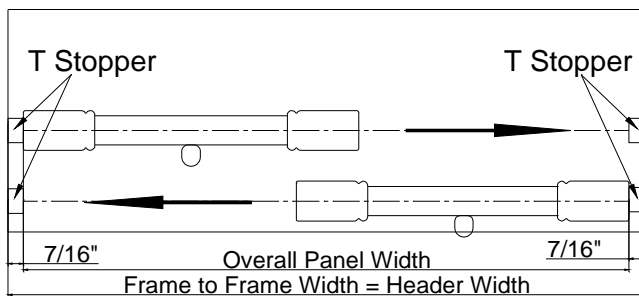

### For IM without side boards

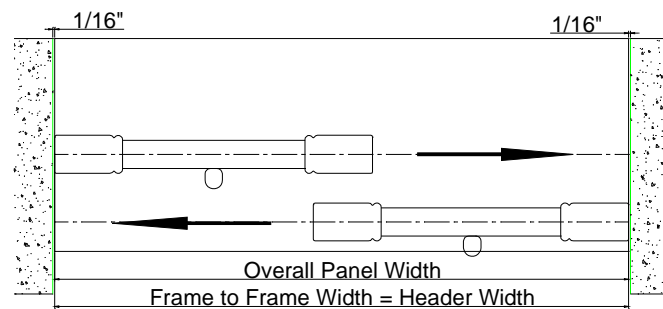

Note: For Semi-Inside/OM without side boards bypass, T Stopper will be supplied.

# 2016 Track Shutters—Bypass

*Normandy Shutters*

## Top View

Combi - joined Panels (optional)

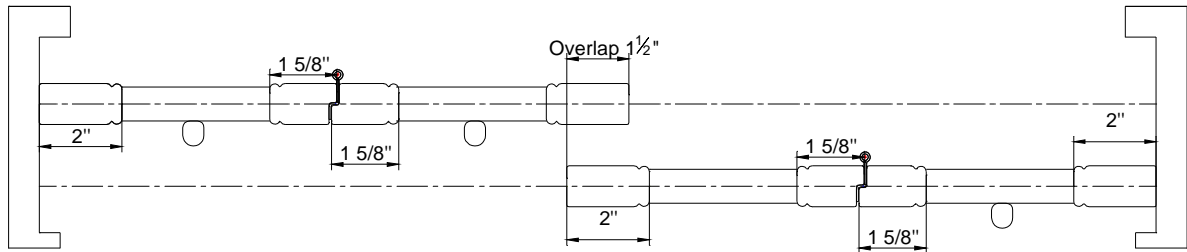

For shutters with 4 or more panels, please select "side open" or "center open"

### Side Open

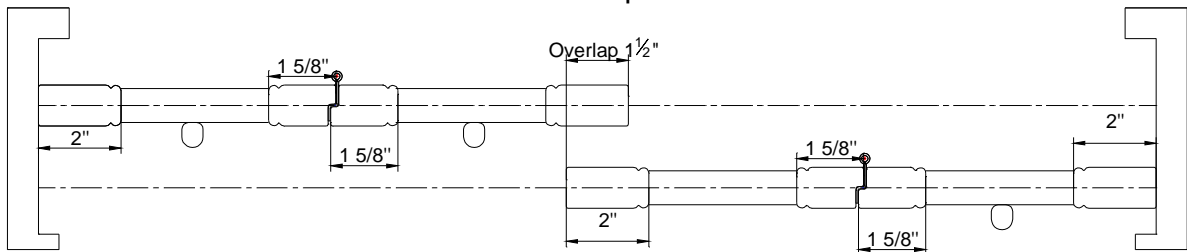

### Center Open

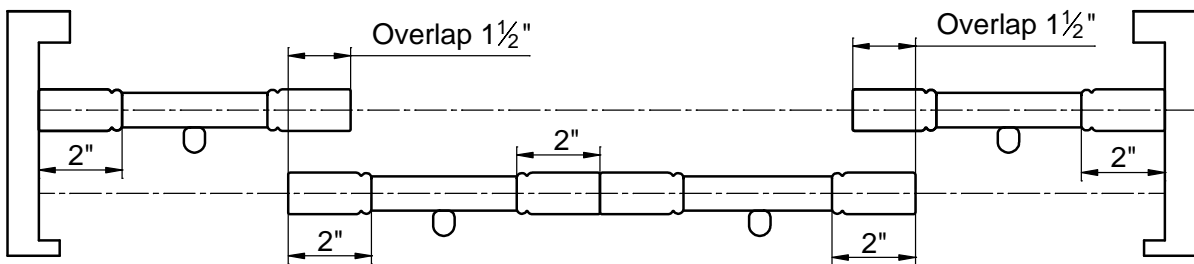

# 2016 Track Shutters—Bypass

*Normandy Shutters*

## 4 panels side open w/Rabbit stile

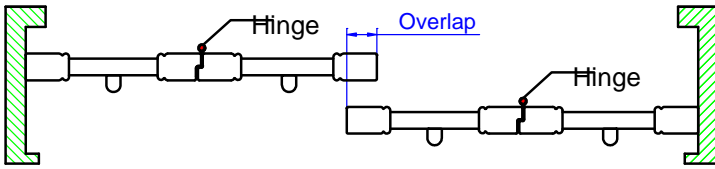

## 4 panels center open w/Rabbit stile

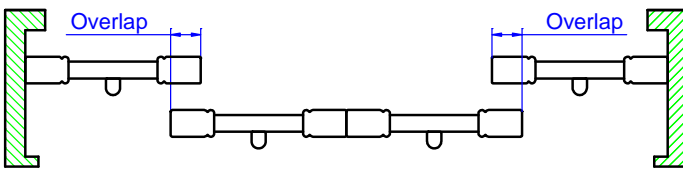

## 6 panels side open w/Rabbit stile

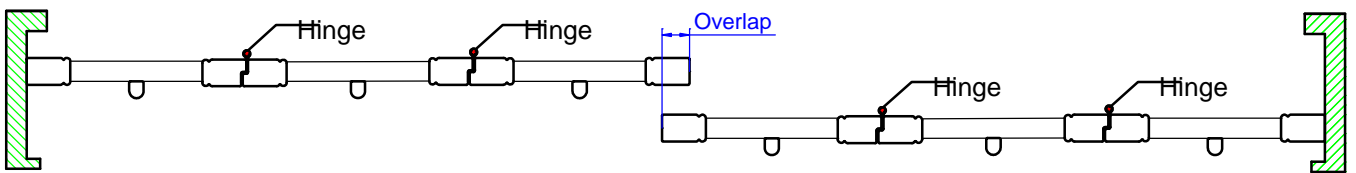

## 6 panels center open w/Rabbit stile

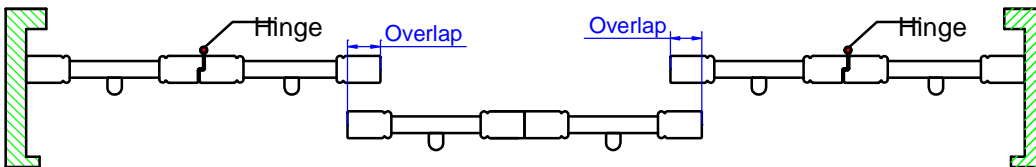

**Stile:** Only 2", 2 1/4" butt and rabbit stiles are available,  
1 5/8" rabbit stile only used for combi-joined panels.  
Center stile is not available.

## Mounting Options (Closed Bypass)

### Side View

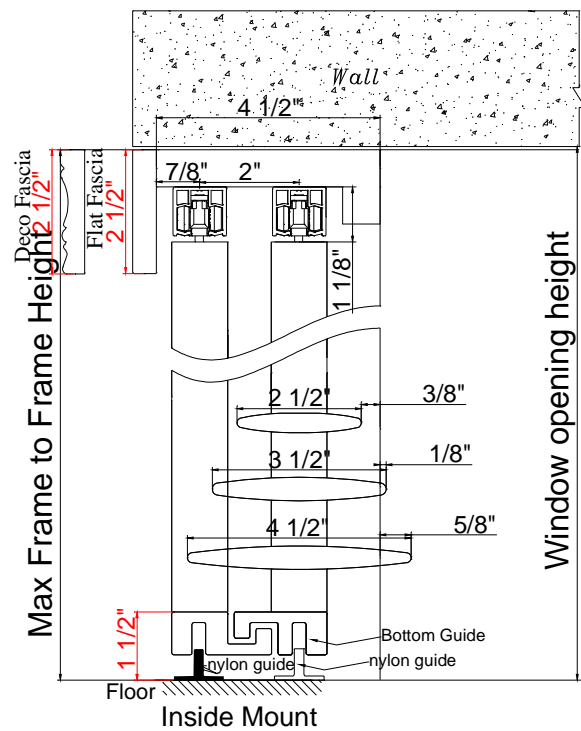
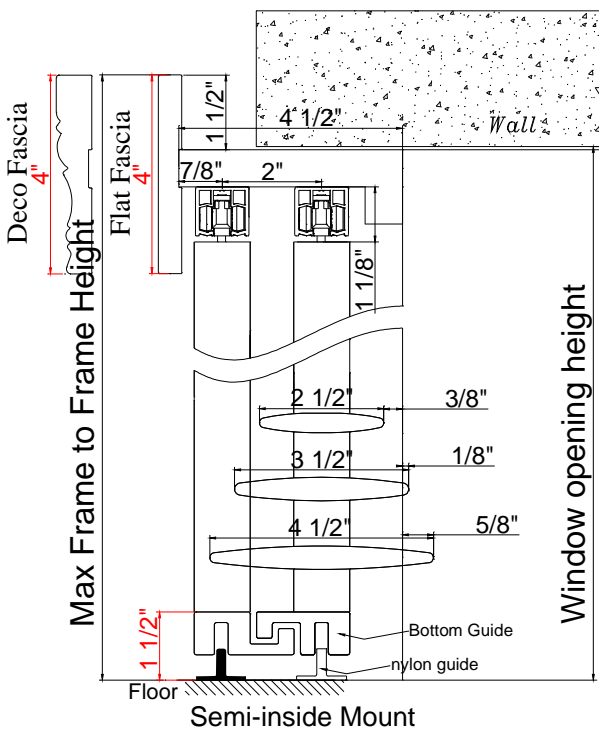
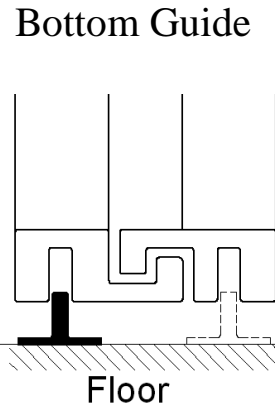
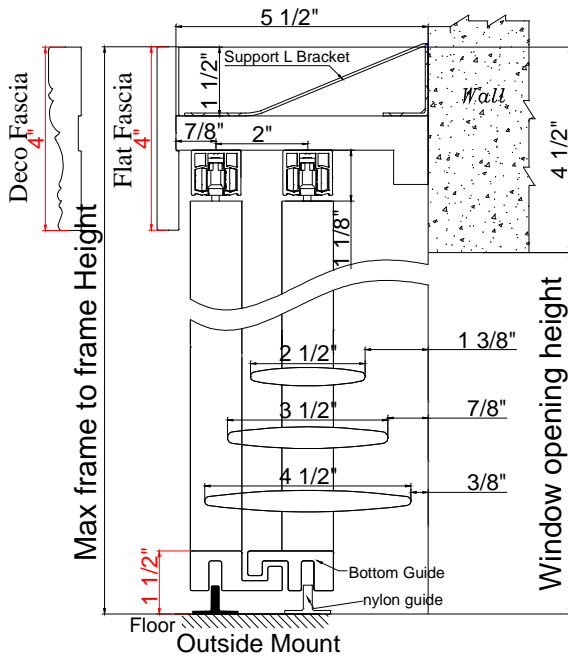

## Mounting Options (Closed Bypass with 3 Tracks):

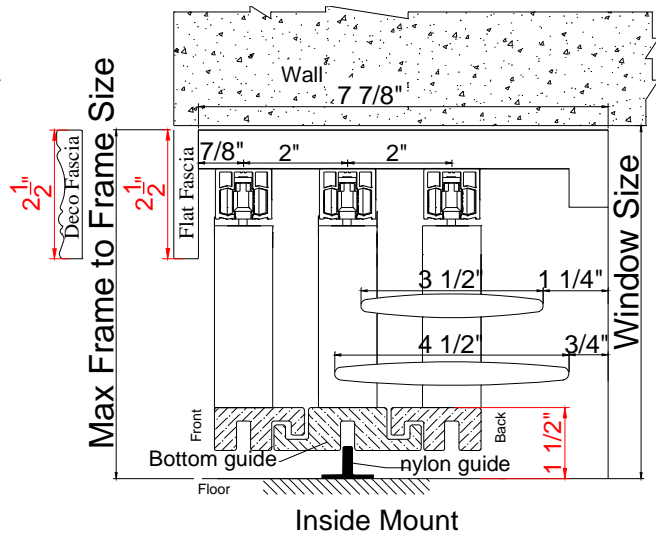
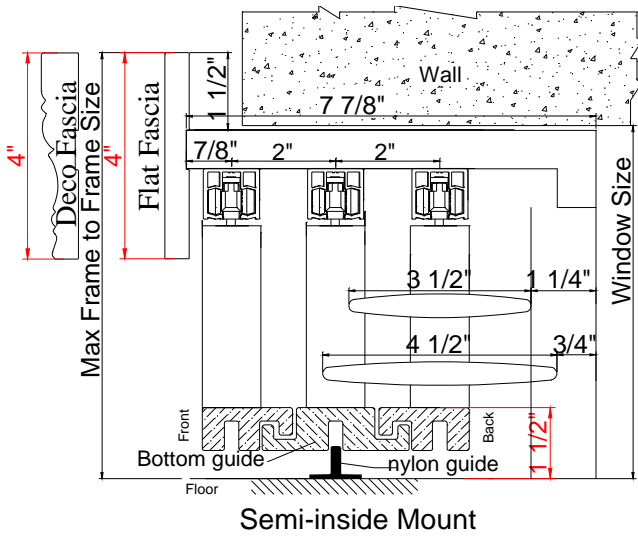
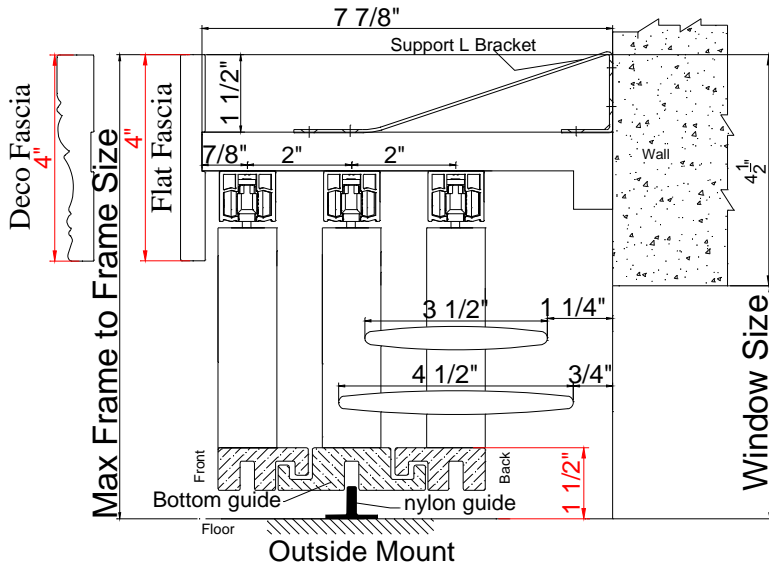

# 2016 Track Shutters—Bypass

*Normandy Shutters*

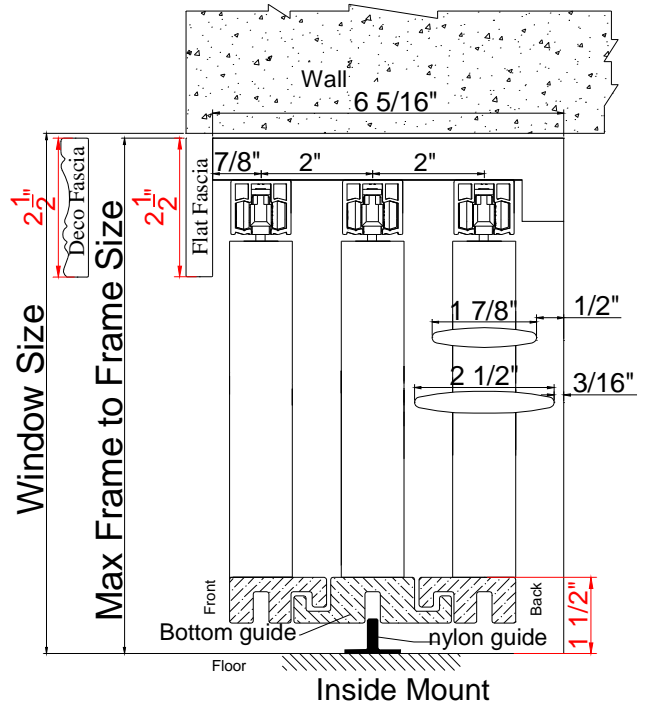
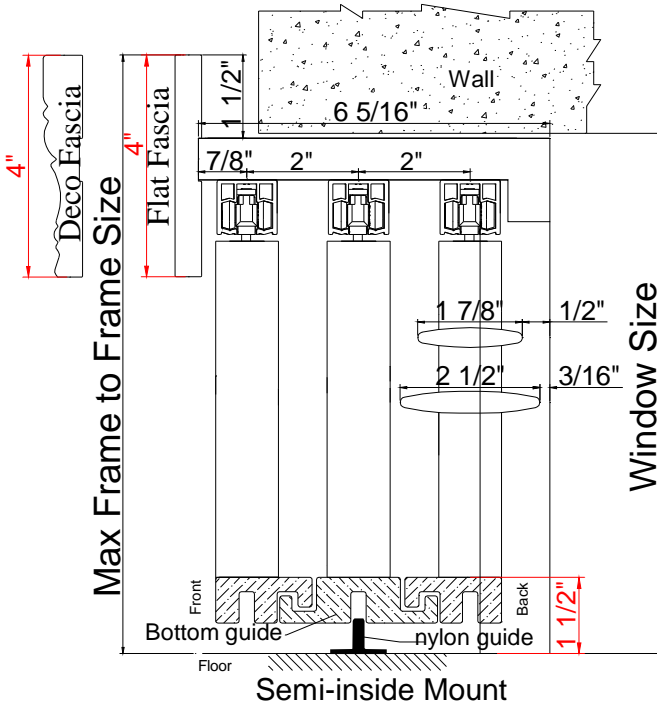
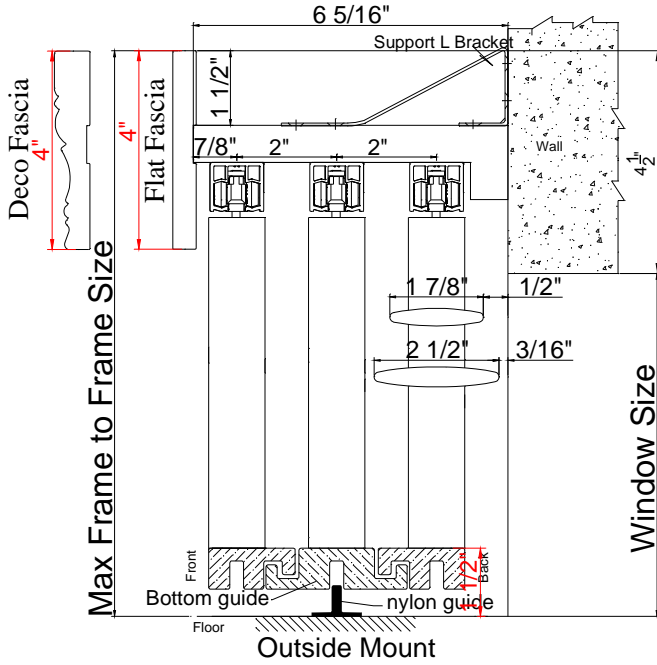



# 2016 Track Shutters—Bypass

*Normandy Shutters*

## Mounting Options (Opened Bypass)

Only available in 2 1/2" and 3 1/2" louver sizes

### 2 1/2" Louver

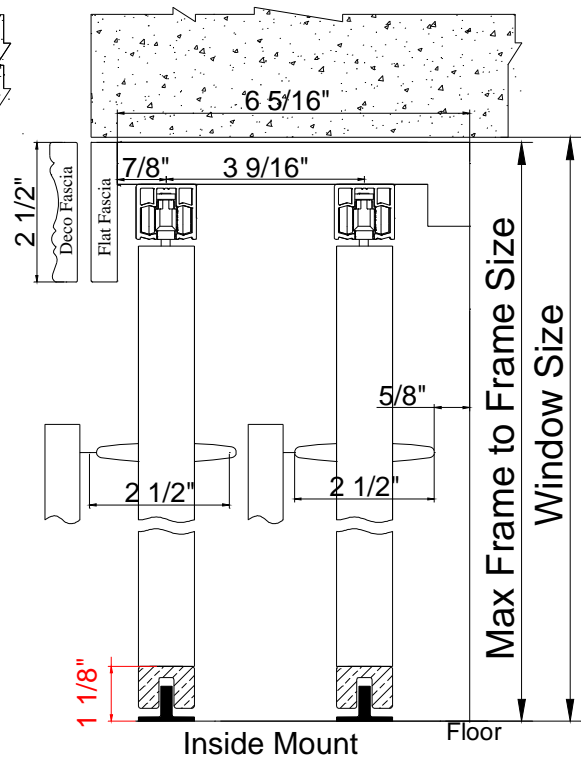
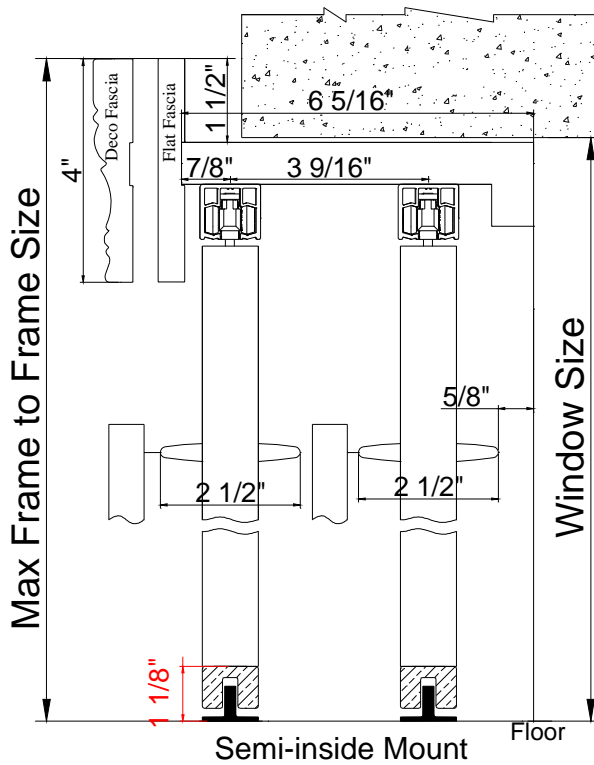
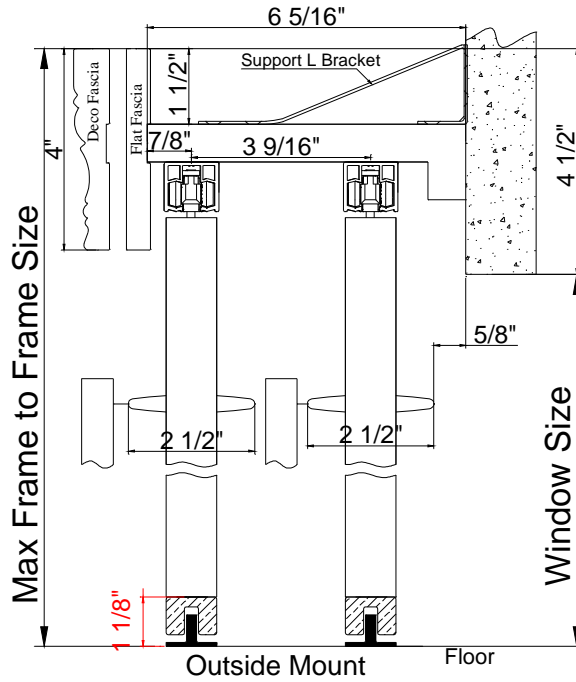

# 2016 Track Shutters—Bypass

*Normandy Shutters*

3 1/2" Louver

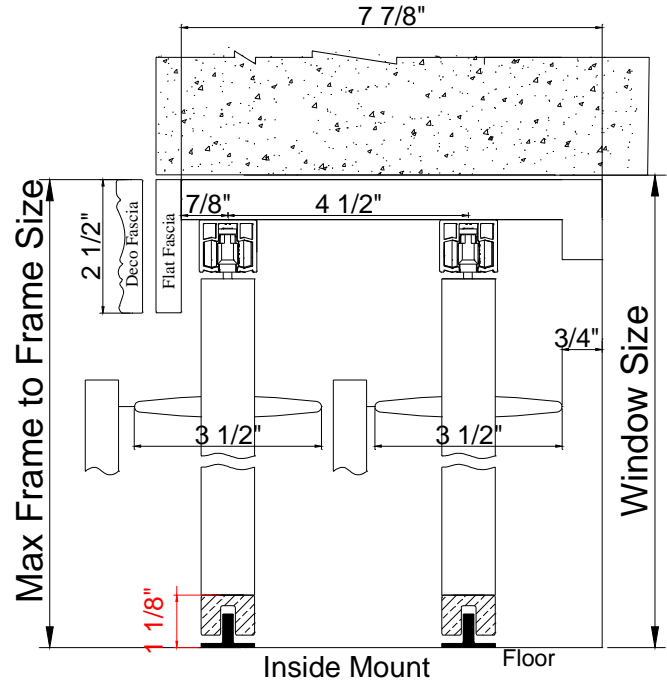
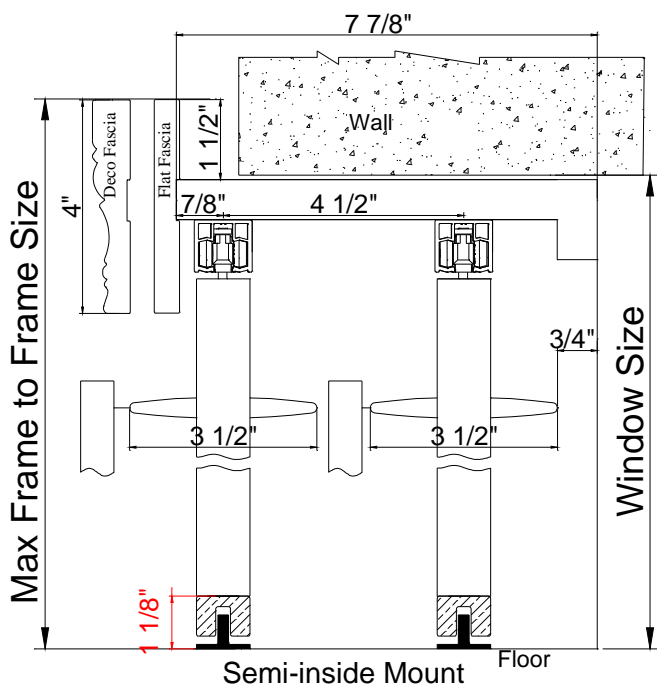
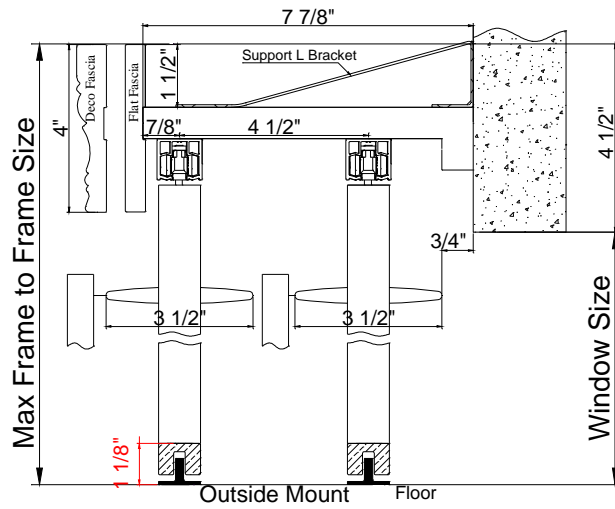

# 2016 Track Shutters—Bypass

*Normandy Shutters*

Open By Pass: has 2 kinds of bottom guide

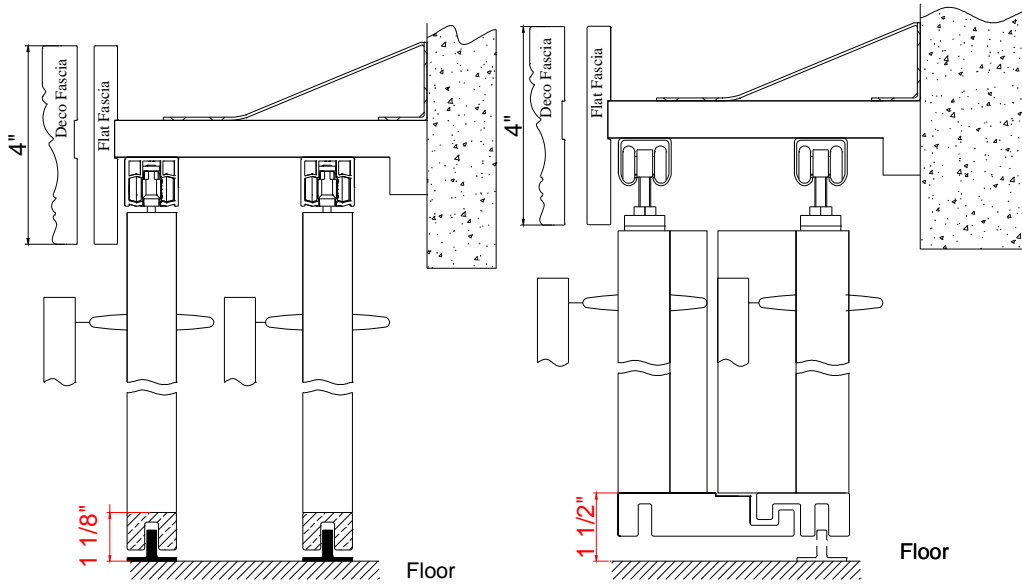

Default Bottom Guide

Optional Interlocking Bottom Guide

## Opened Bypass

### Top View

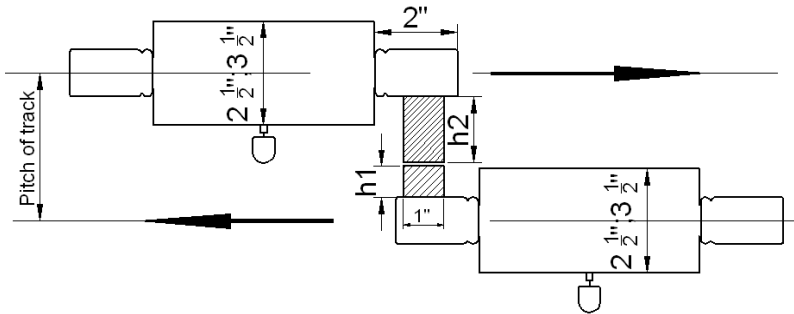

Note: The light block for open bypass will be changed to use screws with wood plugs instead of current dowels.

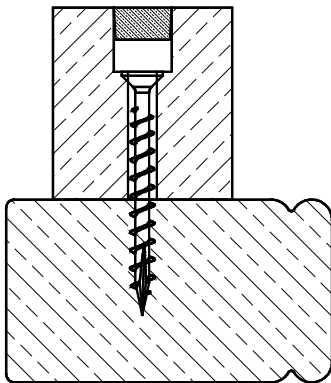

# 2016 Track Shutters—Bypass



## Separation of track

Louver	U shape bottom guide		Interlocking bottom guide	
	Regular Tilt Rod	Invisible tilt	Regular Tilt Rod	Invisible tilt
2.5"	3 9/16"	2 3/4"	3 9/16"	3 9/16"
3.5"	4 1/2"	3 5/8"	4 1/2"	4 1/2"

## Light block thickness for panel

Louver		U shape bottom guide		Interlocking bottom guide	
		Regular Tilt Rod	Invisible tilt	Regular Tilt Rod	Invisible tilt
2.5"	h1	3/4"	3/4"	3/4"	3/4"
	h2	1 9/16"	3/4"	1 9/16"	1 9/16"
3.5"	h1	1 3/16"	1 3/16"	1 3/16"	1 3/16"
	h2	1 15/16"	1 3/16"	1 15/16"	1 15/16"

**Nylon Guide:** The nylon guide is composed by 2 parts and will supplied as a whole set by default (bottom part 16mm and top part 5mm), please remove the top part if necessary.

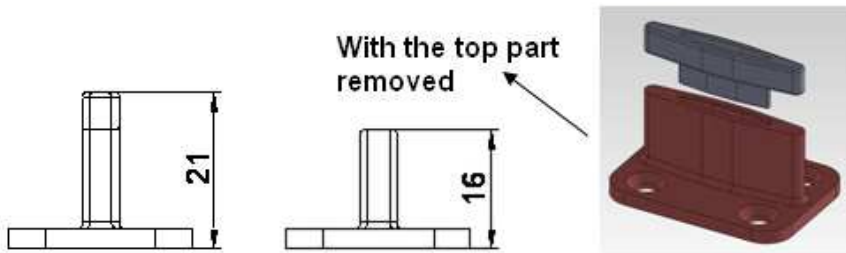

# 2016 Track Shutters—Bypass



## Track Shutters Framing Materials

Framing	Size				Pc(s)
<b>L Shape Header</b>	<b>Header (Closed Bypass)</b>	<b>Header (Opened Bypass)</b>	<b>Supporting Strip</b>		1 pc
<b>(2 in 1)</b>	$\frac{3}{4}$ " x $5\frac{1}{2}$ "* (Default for Outside Mount; Optional for Semi-Inside and Inside Mount)	$\frac{3}{4}$ " x $6\frac{1}{4}$ "* ( $2\frac{1}{2}$ " Louver)	$\frac{3}{4}$ " x $\frac{3}{4}$ "		
Header with Supporting Strip	$\frac{3}{4}$ " x $4\frac{1}{2}$ "* (Default for Semi-Inside and Inside Mount; Optional for Outside Mount)	$\frac{3}{4}$ " x $7\frac{13}{16}$ "* ( $3\frac{1}{2}$ " Louver)			
	Custom * $\leq 8$ "	Custom * $\leq 8$ "			
<b>U Shape Side Frame</b>	<b>Side Frame (Closed Bypass)</b>	<b>Side Frame (Opened Bypass)</b>	<b>Supporting Strip</b>	<b>Side Fascia</b>	2 pcs
<b>(3 in 1)</b>	$\frac{3}{4}$ " x $5\frac{7}{8}$ "* (Default for Outside Mount; Optional for Semi-Inside and Inside Mount)	$\frac{3}{4}$ " x $6\frac{5}{8}$ "* ( $2\frac{1}{2}$ " Louver)	$\frac{3}{4}$ " x $\frac{3}{4}$ "	$\frac{3}{8}\frac{3}{8}$ " x $1\frac{1}{4}$ "	
Side Frame with Supporting Strip & Side Fascia	$\frac{3}{4}$ " x $4\frac{7}{8}$ "* (Default for Semi-Inside and Inside Mount; Optional for Outside Mount)	$\frac{3}{4}$ " x $8\frac{1}{4}$ "* ( $3\frac{1}{2}$ " Louver)			
	Custom * $\leq 8$ "	Custom * $\leq 8$ "			
Top Fascia (Plain/Deco)	4" (Semi-inside and Outside Mount)				1 pc
	$\frac{1}{2}$ " x $2\frac{1}{2}$ " (Inside Mount)				
Top Fascia Return	4" (Semi-inside and Outside Mount)				2 pcs
	N/A (Inside Mount)				

# Hardware Box

Hardware Box
<b>Part</b>
Wrench
Nylon Guide
¾ " screws for Nylon Guide
Support L Bracket (based on the length of header)
2 ½ " screws for support L bracket
¾ " screws for support L bracket

## Special Options

### Café Shutters\*

- The top of the panel requires a special finish. Please indicate “café shutter” when placing orders.
- The shutter does not come with recessed magnet on top.

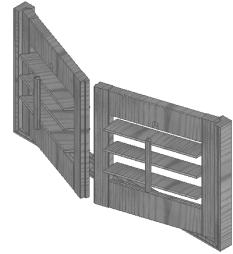
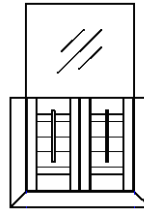

### Double-Hung Shutters\*

- For total number of panels, please include panels in both rows.
- For panel configuration, please provide panel fold for one row.
- The default location for the division point is the center unless specified otherwise.
- Horizontal T Post\* can be added for increased structural integrity.

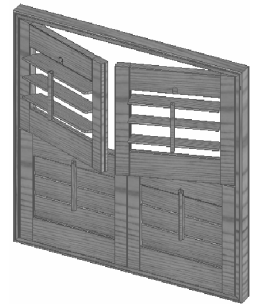
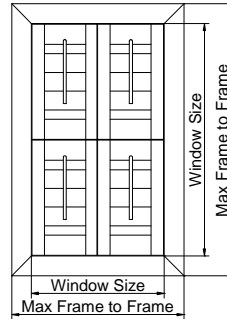

### Fixed Louvers

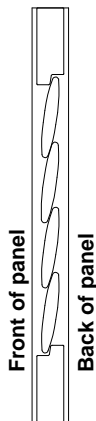
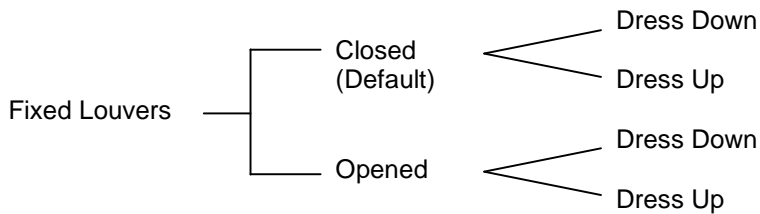

Closed, dressed down

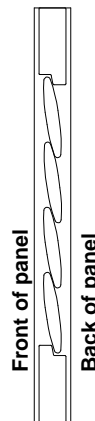

Closed, dressed up

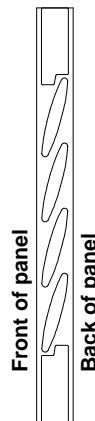

Opened, dressed down

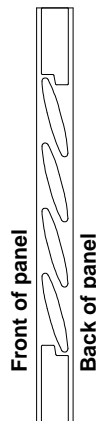

Opened, dressed up

ND k-1

\* Surcharge applies. Please see Options and Surcharges page for details.

# Special Options

## French Door Cut-out Collection\*

- Flush and offset cutout options are available in both curved and square French door cutout.
  - ◊ Offset cutout is good option for French Door with molding around the glass.
- All French door cutouts are only available in L frame except Type E and F. The batten is placed behind the Type E/F panel to block light.

Louver size	Batten Width	Batten thickness
1 7/8" & 2 1/2"	3/4"	1"
3 1/2"	3/4"	1 3/8"
4 1/2"	3/4"	1 7/8"

- For measurement details please refer to Form section.

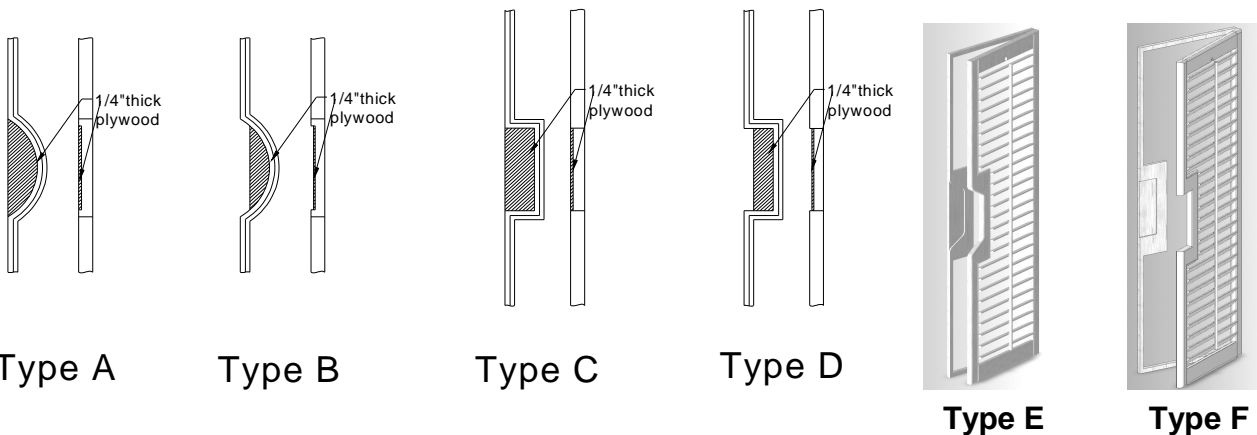

## Shutters to be installed in Angled or Horizontal Skylight Window Openings

If shutters are going to be installed in angled or horizontal skylight window openings, please specify on the order form.

<b>Available Material</b>	Wood Shutters (Not available for Motorized Shutters)
<b>Available Frame Type</b>	Frame with light block thickness not less than 3/4"
<b>Max Panel Size</b>	26" W x 78"H
<b>Tilt Rod</b>	Invisible Tilt
<b>Panel Configuration</b>	single panel or single panels with T-Posts
<b>Hardware for unhinged side</b>	Panel Lock on top and bottom + 2 Button Catches





# Specialties



## Specialty Shutters\*

Specialty shutters are made of premium solid wood, finished to match the beauty of all Norman shutters. Templates are required if it is an imperfect specialty. Delivery time is 8 weeks from the order confirmation date for all specialty shutters. Please refer to Specialties and Template Requirement sections for details.

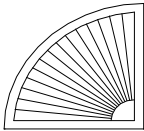
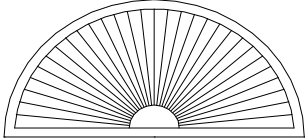
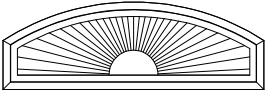
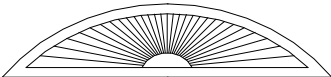
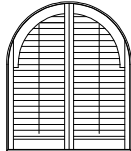
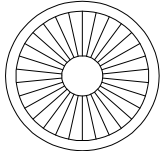
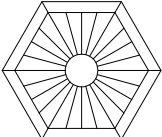
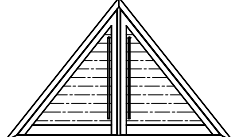
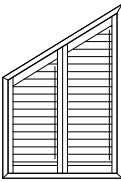
- \* All frames for specialty shutters will be made as solid frames (not with an insert). However, if there is a regular shutter below a specialty shutter and the frames for both shutters are separated by a divider strip, then the top frame will be made as a solid frame but the bottom frames will be made as regular frames with inserts. If the top frames and the side frames are not separated by a divider strip, both side frames and the bottom frames will be made as solid frames.

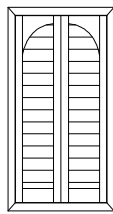
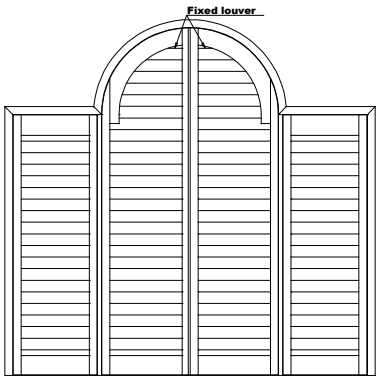
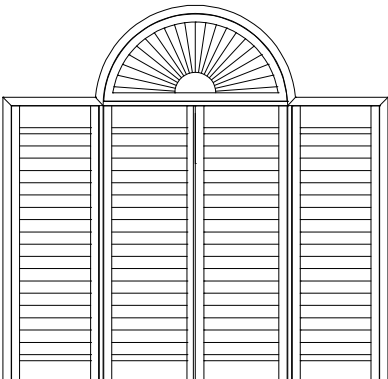
Arch Windows	Special Shapes
<div style="display: flex; justify-content: space-around;"> <div style="text-align: center;">  <p>Quarter Round Sunburst</p> </div> <div style="text-align: center;">  <p>Half Round Sunburst</p> </div> </div> <div style="display: flex; justify-content: space-around; margin-top: 20px;"> <div style="text-align: center;">  <p>Elongated Eyebrow Sunburst</p> </div> <div style="text-align: center;">  <p>Eyebrow Sunburst</p> </div> </div>	<div style="display: flex; justify-content: space-around;"> <div style="text-align: center;">  <p>Louvered Arch w/ Center Tilt Rod</p> </div> <div style="text-align: center;">  <p>Circle Sunburst</p> </div> </div> <div style="display: flex; justify-content: space-around; margin-top: 20px;"> <div style="text-align: center;">  <p>Hexagon Sunburst</p> </div> <div style="text-align: center;">  <p>Triangle</p> </div> </div>
<p><b>Angle Top</b></p>	<p><b>Louver Arch in a Rectangle</b></p>
<div style="display: flex; justify-content: space-between;"> <div style="text-align: center;">  <p>Angle Top</p> </div> <div style="text-align: center;">  <p>*Top louver of angle top might be fixed as shown above</p> </div> </div>	 <p>Louver Arch in a Rectangle</p>
<p><b>Arch Top Picture Window with horizontal louvers</b></p>	<p><b>Arch Top Picture Window with Sunburst</b></p>
 <p style="font-size: small; margin-left: 100px;">Fixed louver</p>	

\* Surcharge applies. Please see Options and Surcharges page for details.

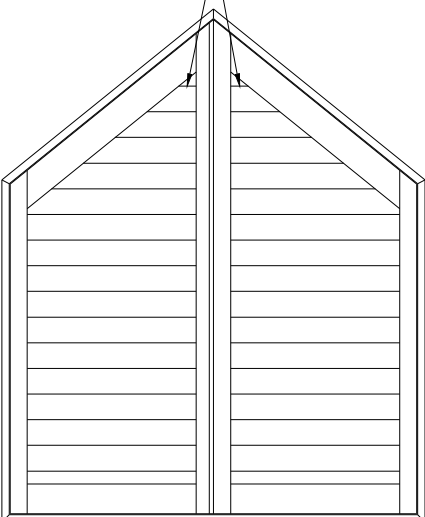
<p><b>Peak</b></p>	
<p><b>Fixed louver</b></p>  <p>The diagram shows a window with a gabled top. The window is divided into two vertical sections by a central muntin. Each section contains horizontal louvers. The louvers are fixed in place, as indicated by the label 'Fixed louver' and the lack of pivot points. The window is set within a frame that follows the gable shape of the top.</p>	

\* Surcharge applies. Please see Options and Surcharges page for details.

# Pricing

<b>1) By Max Frame-to-Frame Measurement:</b>							
<b>Regular Shutter</b>							
Inside and Outside Mount	Width	x	Height	/ 144	x		\$/sq ft
<b>Track Shutter**</b>							
Inside	Width	x	Height	/ 144	x		\$/sq ft
Semi-Inside and Outside Mount	Width	x	(Height-1½")	/ 144	x		\$/sq ft
<b>2) By Net Panel Measurement:</b>		Width	x	Height	/ 144	x	\$/sq ft
<b>3) By Window Size:</b>							
<b>2" Camber Deco Frame</b>	4-sided	(Width+4")	x	(Height+4")	/ 144	x	\$/sq ft
	3-sided with Designer Sill Cap	(Width+4")	x	(Height+8")	/ 144	x	\$/sq ft
	3-sided with Sill Plate	(Width+4")	x	(Height+4")	/ 144	x	\$/sq ft
	3-sided	(Width+4")	x	(Height+2")	/ 144	x	\$/sq ft
	2-sided with Designer Sill Cap	(Width+4")	x	(Height+6")	/ 144	x	\$/sq ft
	2 sided with Sill Plate	(Width+4")	x	(Height+2")	/ 144	x	\$/sq ft
	2-sided	(Width+4")	x	(Height)	/ 144	x	\$/sq ft
<b>3" Ridge Deco Frame</b>	4-sided	(Width+6")	x	(Height+6")	/ 144	x	\$/sq ft
	3-sided with Deco Sill Frame	(Width+6")	x	(Height+6")	/ 144	x	\$/sq ft
	3-sided with Designer Sill Cap	(Width+6")	x	(Height+9")	/ 144	x	\$/sq ft
	3-sided with Sill Plate	(Width+6")	x	(Height+6")	/ 144	x	\$/sq ft
	3-sided	(Width+6")	x	(Height+3")	/ 144	x	\$/sq ft
	2-sided with Deco Sill Frame	(Width+6")	x	(Height+3")	/ 144	x	\$/sq ft
	2-sided with Designer Sill Cap	(Width+6")	x	(Height+6")	/ 144	x	\$/sq ft
	2-sided with Sill Plate	(Width+6")	x	(Height+3")	/ 144	x	\$/sq ft
2-sided	(Width+6")	x	(Height)	/ 144	x	\$/sq ft	
<b>3" Crown Z Frame</b>	4-sided	(Width+4 ½")	x	Height+4½")	/ 144	x	\$/sq ft
	3-sided with Designer Sill Cap	(Width+4 ½")	x	Height+8½")	/ 144	x	\$/sq ft
	3-sided with Sill Plate	(Width+4 ½")	x	Height+4½")	/ 144	x	\$/sq ft
	3-sided	(Width+4 ½")	x	Height+2½")	/ 144	x	\$/sq ft
	2-sided with Designer Sill Cap	(Width+4 ½")	x	(Height+6")	/ 144	x	\$/sq ft
	2-sided with Sill Plate	(Width+4 ½")	x	Height+2½")	/ 144	x	\$/sq ft
	2-sided	(Width+4 ½")	x	(Height)	/ 144	x	\$/sq ft
<b>2" Bel Air Z Frame</b>	4-sided	(Width+2 ½")	x	Height+2½")	/ 144	x	\$/sq ft
	3-sided with Designer Sill Cap	(Width+2 ½")	x	Height+7¼")	/ 144	x	\$/sq ft
	3-sided with Sill Plate	(Width+2 ½")	x	Height+2½")	/ 144	x	\$/sq ft

# *Normandy® Shutters*

	3-sided	(Width+2 ½")	x	Height+1¼"	/ 144	x	\$/sq ft
	2-sided with Designer Sill Cap	(Width+2 ½")	x	(Height+6")	/ 144	x	\$/sq ft
	2-sided with Sill Plate	(Width+2 ½")	x	Height+1¼"	/ 144	x	\$/sq ft
	2-sided	(Width+2 ½")	x	(Height)	/ 144	x	\$/sq ft
<b>1 ½ " Bullnose Z Frame</b>	4-sided	(Width+2")	x	(Height+2")	/ 144	x	\$/sq ft
	3-sided with Designer Sill Cap	(Width+2")	x	(Height+7")	/ 144	x	\$/sq ft
	3-sided with Sill Plate	(Width+2")	x	(Height+2")	/ 144	x	\$/sq ft
	3-sided	(Width+2")	x	(Height+1")	/ 144	x	\$/sq ft
	2-sided with Designer Sill Cap	(Width+2")	x	(Height+6")	/ 144	x	\$/sq ft
	2-sided with Sill Plate	(Width+2")	x	(Height+1")	/ 144	x	\$/sq ft
	2-sided	(Width+2")	x	(Height)	/ 144	x	\$/sq ft
<b>Vintage Hang Strip</b>	Inside	Width	x	Height	/ 144	x	\$/sq ft
	Outside 4-sided	(Width+3")	x	(Height+3")	/ 144	x	\$/sq ft
	Outside 3-sided with Designer Sill Cap	(Width+3")	x	Height+7½"	/ 144	x	\$/sq ft
	Outside 3-sided	(Width+3")	x	Height+1½"	/ 144	x	\$/sq ft
	Outside 2-sided with Designer Sill Cap	(Width+3")	x	(Height+6")	/ 144	x	\$/sq ft
	Outside 2-sided	(Width+3")	x	(Height)	/ 144	x	\$/sq ft
		Inside (max frame to frame measurement only)	Width	x	Height	/ 144	x
<b>Beaded L Frame/</b>	Outside 4-sided	(Width+3")	x	(Height+3")	/ 144	x	\$/sq ft
<b>Colonial L Frame/</b>	Outside 3-sided with Designer Sill Cap	(Width+3")	x	Height+7½"	/ 144	x	\$/sq ft
<b>Bullnose L Frame/</b>	Outside 3-sided	(Width+3")	x	Height+1½"	/ 144	x	\$/sq ft
<b>Vintage L Frame</b>	Outside 2-sided with Designer Sill Cap	(Width+3")	x	(Height+6")	/ 144	x	\$/sq ft
	Outside 2-sided	(Width+3")	x	(Height)	/ 144	x	\$/sq ft
<b>Track Shutter**</b>							
	Inside and Semi-Inside Mount	Width	x	Height	/144	x	\$/sq ft
	Outside Mount	(Width+3")	x	(Height+3")	/144	x	\$/sq ft

# Options & Surcharges

Option	Surcharge	Remark
Beaded L Frame with ¼" Thick Light Block	No surcharge	
L Frame with ½" & 1" Buildout	5%	
Notch Out L Frame	10%	
Deco Frame with ½", 1" & 1½" Extension	5%	
Custom Extension	10%	Up to 2" for L Frames, Deco Frames and Hang Strip (OM)
		Up to 1" for Z Frames (not available for Tilt Out Z frame)
T Post	No surcharge	
T Post Extension	5%	Up tp 2"
Custom width T Post	5%	Up tp 7½"
90 degree Corner Post & 135 degree Bay Post	No surcharge	
Double Hung / Horizontal 1¼" T Post	10%	
Custom Angle/Depth Bay Post	5%	Up to 2" for custom depth
Extra Light Block	Charge per linear ft	Please contact your Customer Account Specialist for details
Scribe Trim	Charge per linear ft	Please contact your Customer Account Specialist for details
Center Tilt Rod	No surcharge	
Offset Tilt Rod	5%	
InvisibleTilt™	10%	
Optimal™ Antimicrobial Treatment	10%	
Café Shutters	30%	Surcharge applies when the frame exceeds 5" beyond the top of the panel.
Fixed Louver Panel	No surcharge	Please indicate fixed position: up/down and open/close
French Door Cutout	See specialty surcharge	Please contact your Customer Account Specialist for details
Track	See specialty surcharge	Please contact your Customer Account Specialist for details
Plain Boxout (Standard size)	40%	
Deco Boxout (Standard size)	40%	
Plain Boxout (Custom size)	40%	
Deco Boxout (Custom size)	40%	
Interlocking Bottom Guide (Opened Bypass)	5%	
Specialties	See specialty surcharge	Please contact your Customer Account Specialist for details
InvisibleHinge™	10%	
Stainless Steel Hinges	5%	

# *Normandy® Shutters*

PerfectTilt (regular)	Per motor, per remote control	Please contact your Customer Account Specialist for details
PerfectTilt (solar)	Per motor, per remote control	Please contact your Customer Account Specialist for details

# Appendix

## Color Coordination Chart

Color ID	Color Name	Hinge Colour
001	Pure White	Pure White
003	Silk White	Silk White
004	Bright White	
006	Pearl	Pearl
009	Creamy	Bisque
012	Crisp Linen	
030	Moondust	Nickel Plated
046	Ice	Silk White
108	Rustic Gray	Nickel Plated
110	Limed White	Silk White
205	Goldenrod	Antique Brass
211	Cherry	
221	Black Walnut	
227	Red Oak	
229	Rich Walnut	
230	Old Teak	
231	Spring Rose	
232	Red Mahogany	
233	Dark Mahogany	
237	Wenge	
242	Auburn	
249	Acorn	

250	Sumatra	
-----	---------	--

# Louver Depth Clearance

**Standard Tilt Rod**

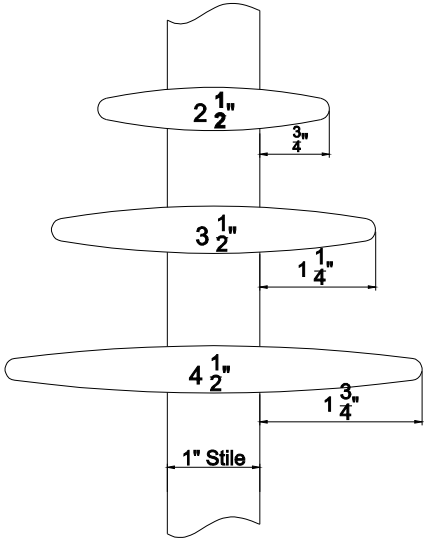

**Offset Tilt Rod**





**New PerfectTilt RF**

The new PerfectTilt RF has many exciting features & benefits.

- No need to plug-in, no cords, no hardwiring
- Tilt multiple panels in sync or individually
- Includes InvisibleTilt™ system, a completely tilt-rod-free solution for a more streamlined view and improved energy efficiency
- Larger solar panels on solar modules absorb more energy than ever before
- Ergonomic remote includes 8 preset angles and can control unlimited number of shutters in range
- Utilizes RF signal, not traditional infrared: for precise reception, range up to 65 ft., no sensor holes, and no need to point remote directly at receiver
- Remote is equipped with a timer, allowing you to use your own computer from anywhere at any time with our proprietary web interface
- Whisper quiet, gear-driven system
- PerfectTilt® RF wires are concealed inside panel, completely hidden from view
- Extra battery packs can be installed as add-on for longer periods between recharges

**Parts and Names:**

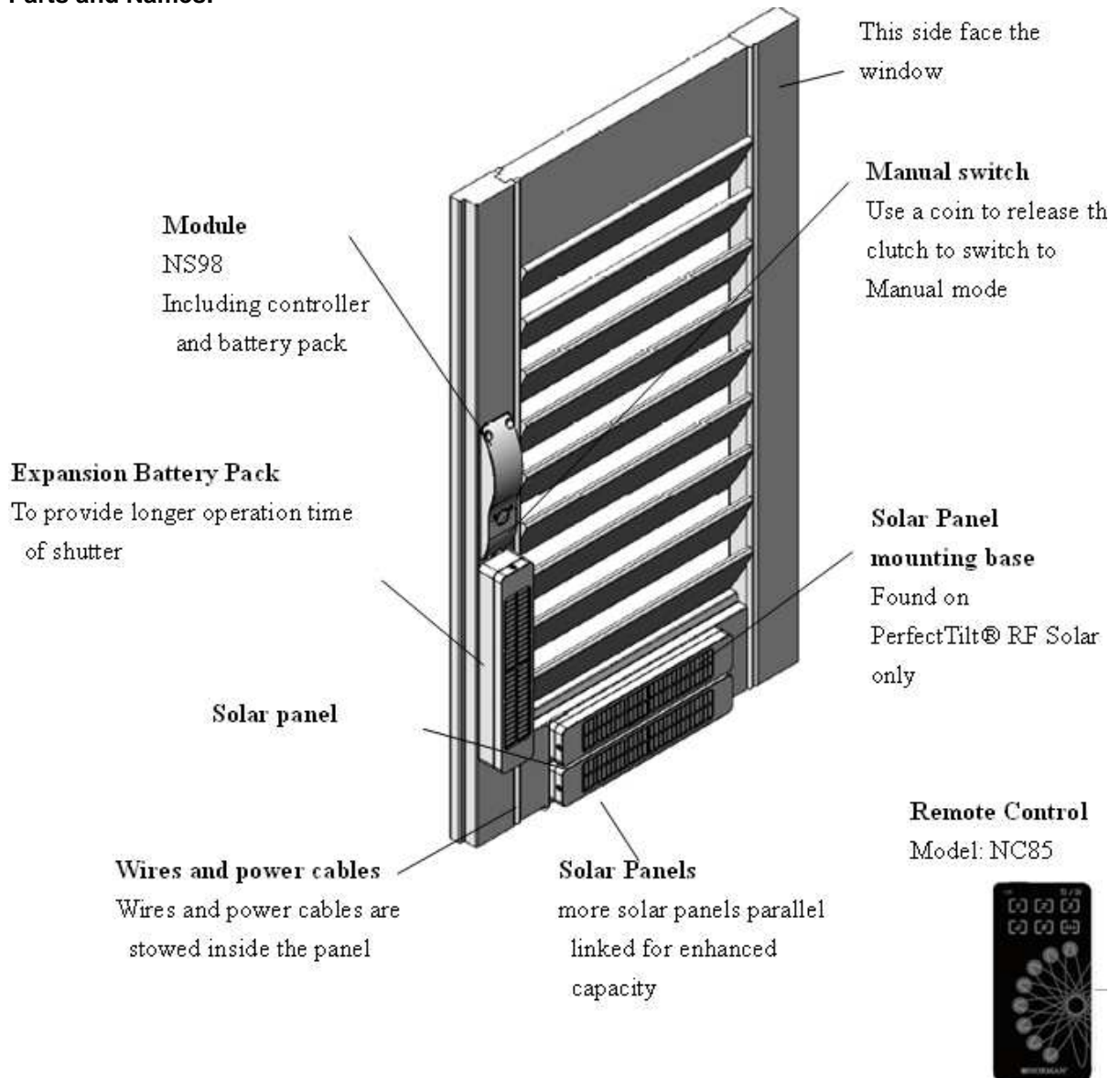



**Specifications:**

<b>New PerfectTilt RF</b>					
Shutter Type	All types except bi-fold double hung or panel with gap at bottom over 0.1" (no support on bottom)				
Specialty Shutter Shape	All shapes except shapes without a vertical stile in the middle (for example, eyebrow, elongated eyebrow, half-round sunburst without horizontal louvers)				
Tilt System	InvisibleTilt only, the tilting system will not split unless specified				
Stile Width	2.25" stile only Center Stile is not available				
Louver	2.5", 3.5", 4.5" Elliptical louver				
Panel Size Limit	<table border="1" style="width: 100%;"> <tr> <td style="width: 50%;">Min. Panel Height (with lined up Motors)</td> <td style="width: 50%;">Min. Panel Height (Default with Staggered Motors)</td> </tr> <tr> <td style="text-align: center;">18"</td> <td>Louver space not less than 26", so at least 13 louvers for 2.5" louver; 9 louvers for 3.5" louver; 7 louvers for 4.5" louver.</td> </tr> </table>	Min. Panel Height (with lined up Motors)	Min. Panel Height (Default with Staggered Motors)	18"	Louver space not less than 26", so at least 13 louvers for 2.5" louver; 9 louvers for 3.5" louver; 7 louvers for 4.5" louver.
	Min. Panel Height (with lined up Motors)	Min. Panel Height (Default with Staggered Motors)			
18"	Louver space not less than 26", so at least 13 louvers for 2.5" louver; 9 louvers for 3.5" louver; 7 louvers for 4.5" louver.				
Max. Panel Height without divider rail: 78" Min. Panel Width Limit: 8 11/16"; 12 5/16" if solar panel is to attach to rail; Max Width Limit: same as regular non-motorized shutters					
Motor Type	NS98				
Remote Control	*Radio frequency *6 channels *8 pre-set angles *Built-in timer function *When ordering, customer needs to specify quantity *Press the "Activation Button" to wake up				
Ring Pull	Ring Pull will be supplied as default. (Refer to "i" page for more information)				
Options	Solar Panel/Expansion battery pack=> surcharge option; customer can choose to add as many Solar Panels/Expansion Battery Packs as long as space allows				

**Components:**

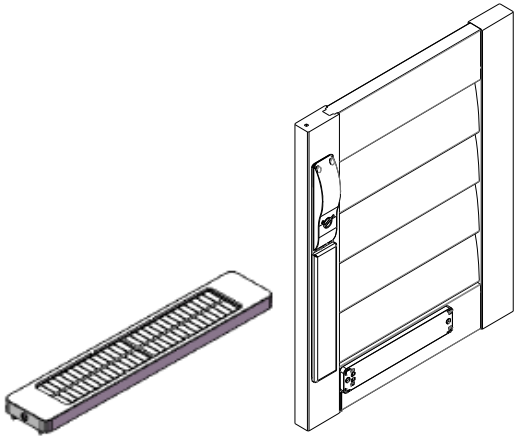
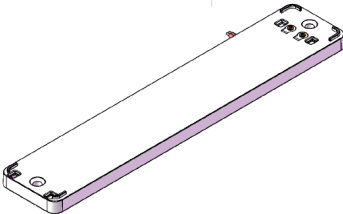
<p>Items</p> <p>Remote Control Model : NC85</p> <p>Radio Frequency; Battery: 2xAAA.</p> <p>Dimensions : 122 x 62 x 16 mm</p> <p>Distance of transmission (control): 20 meters indoor, 40 meters outdoor</p>	
<p>Module</p> <p>Model : NS98</p> <p>Colors Available: White; Coffee; Caramel</p> <p>Dimensions : 330.5 x 37.5 x 40 mm</p> <p>One for each louver section, 6xAA normal batteries or rechargeable batteries are required. Either alkaline or lithium batteries may be used.</p>	
<p>Battery cartridge</p> <p>Make sure the batteries are fit into the cartridge in correct direction, and when fit the cartridge into the module, also in right direction (follow the arrow).</p>	
<p>Battery Expansion Pack</p> <p>Colors Available: White; Coffee; Caramel</p> <p>Dimensions: 195 x 37 x 21.6 mm</p>	

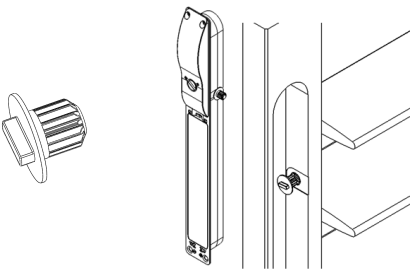
<p>Solar panel</p> <p>Colors Available: White; Coffee; Caramel</p> <p>Dimensions: 195 x 37 x 13,5 mm</p> <p>Position:</p> <p>A. attached to the module itself (Default)</p> <p>B. attached to rail (Optional with surcharge)—For panels with modules below the mid rail or panels without mid rail, the solar panel will be attached to the bottom rail; For panels with modules above mid rail, the solar panel will be attached to the top rail.</p>	
<p>Mounting base (for Solar panel )</p> <p>Colors Available: White; Coffee; Caramel</p> <p>Dimensions: 195 x 37 x 8,5 mm</p> <p>With Power cable</p> <p>Colors: Coffee; White</p>	
<p>USB Cable</p> <p>Color: Black</p> <p>Connect the computer and the remote control to set up timer function.</p>	
<p>Slotted Point Driver</p> <p>One for each louver section.</p> <p>Connect the Easy Tilt and the Module; when fit the slotted point driver into the stile, make sure the angle is the same as that of the louvers.</p>	

**Color Coordinate Chart:**

	NO.	Color ID	Color Name	Module/Battery Expansion Pack/Solar Panel Color
8 Paint	1	001	Pure White	White
	2	003	Silk White	White
	3	004	Bright White	White
	4	006	Pearl	White
	5	009	Creamy	White

	6	012	Crisp Linen	White
	7	030	Moondust	White
	8	046	Ice	White
15 Stain	1	108	Rustic Grey	Coffee
	2	110	Limed White	White
	3	205	Goldenrod	Caramel
	4	211	Cherry	Coffee
	5	221	Black Walnut	Coffee
	6	227	Red Oak	Caramel
	7	229	Rich Walnut	Coffee
	8	230	Old Teak	Coffee
	9	231	Spring Rose	Coffee
	10	232	Red Mahogany	Coffee
	11	233	Dark Mahogany	Coffee
	12	237	Wenge	Coffee
	13	242	Auburn	Caramel
	14	249	Acorn	Coffee
	15	250	Sumatra	Coffee

#### **Wood Cover**

The battery cover of the module would come with a wood cover that covers at least half section of the module. And the color of the wood cover will match that of the shutter.

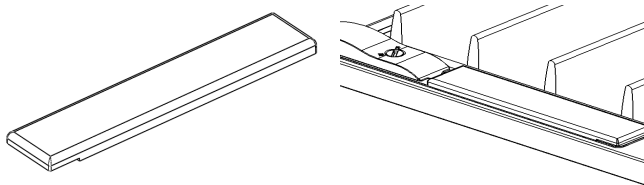

If Expansion Battery Pack or Solar Panel is to fix on the module, please keep the wood cover and in the future if the expansion battery pack or the solar panel is not needed, the wood cover can be put back in use.

#### ✧ Frame Cut-Out

For single panel or configuration similar to single panel with frame, the module location will conflict with the light block of the frame, so there will be cut-out on the light block of the frame to stop the conflict, the length for the cut-out would be 335mm

**Clearance:**

	Module	Battery Expansion Pack	Solar Panel	Solar Panel Mounting Base
Thickness	11/16"(17.5mm)	43/64" (17mm)	23/64"(9mm)	11/32"(8.5mm)

**The module will protrude 11/16" from the back of the stile, please allow 3/4" clearance for the module.**

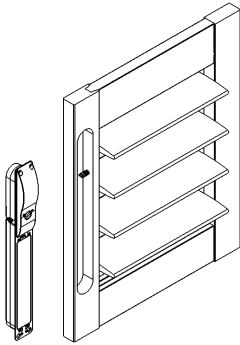

E.g.: Below is the situation **not available** for the module unless enough build-out is added to the frame.

Hang Strip OM: beside the panels

When module is on the left/right most stiles, the protrusion part will conflict with the wall.

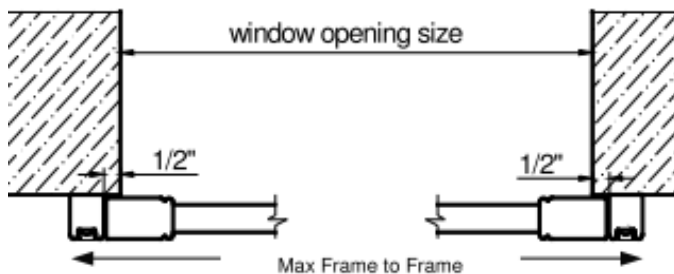

L Frame with light block thickness less than 3/4" OM:

When module is on the left/right most stiles, the protrusion part will conflict with the wall.



**If both Solar Panel and one Battery Expansion Pack is attached to the module, the necessary clearance is 1 1/8";**

**When more Battery Expansion Packs are needed, please add build-out to allow**

enough clearance.

Side view for module in panel with different louver types

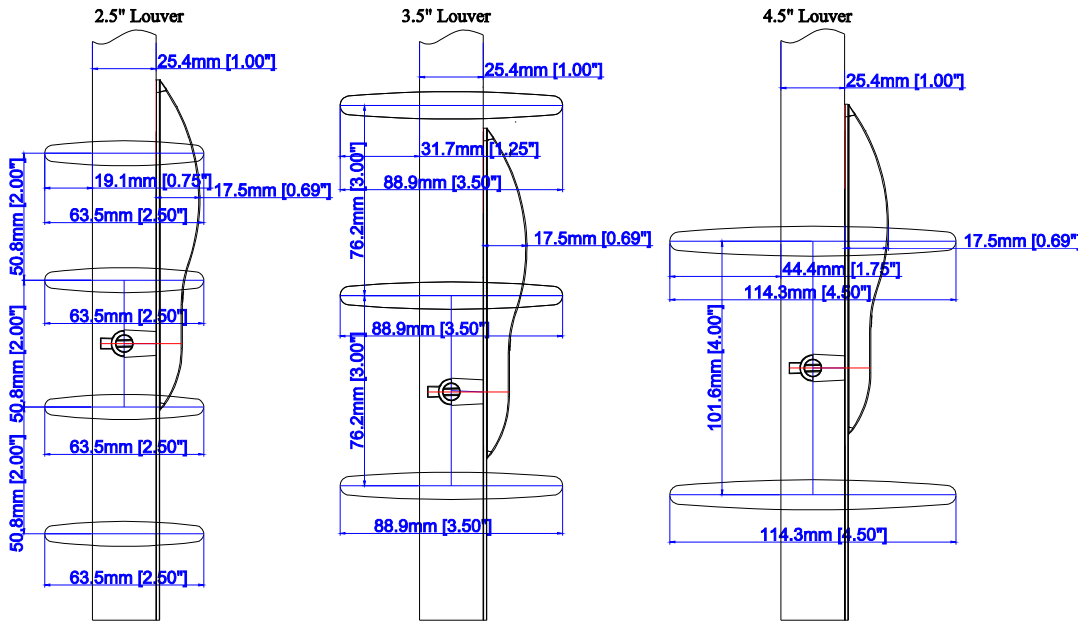

**For Motorized 90° Bifold Track Shutter:**

- 1) Both 3" and 3.5" Header are available;
- 2) The L Shape Light Block will be cut out 5/16" to avoid the conflict with the module;

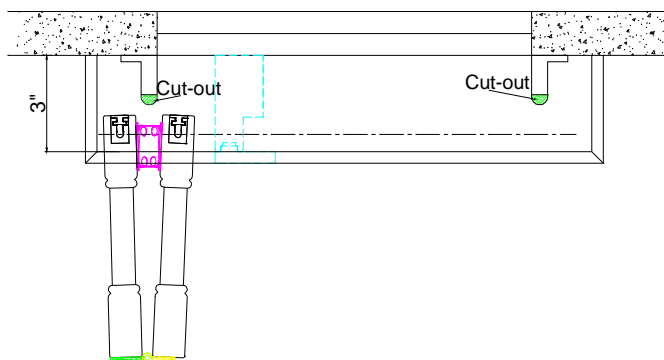
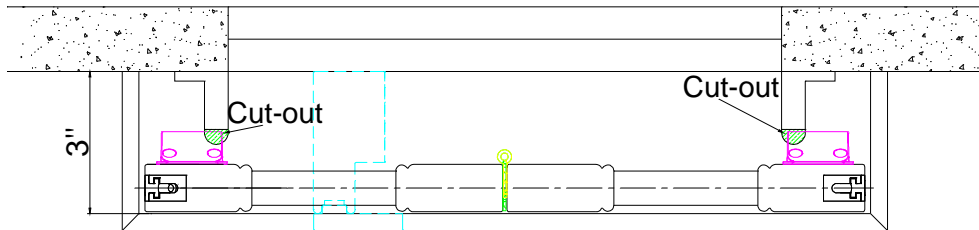

- 3) For Motorized shutter with both Solar Panel and Expansion Battery Pack attached to

the back of the module, the L Shape Light Block will be cut out 11/16" to avoid the conflict;

Available options:

- a. One Solar Panel;
  - b. One Expansion Battery Pack;
  - c. One Solar Panel and One Expansion Battery Pack.
- 4) It is not recommended to have solar panels for the leftmost or rightmost panel due to the lack of sunlight;

**For Motorized 180° Bifold Track Shutter:**

- 1) The default header width is 3.5"; The min. Header width is 3.25"; so for 3" header, 0.25" extension is required;
- 2) The L Shape Light Block will be cut out to avoid the conflict with the module; 0.2" extension is necessary for installation of the top and bottom pivots;

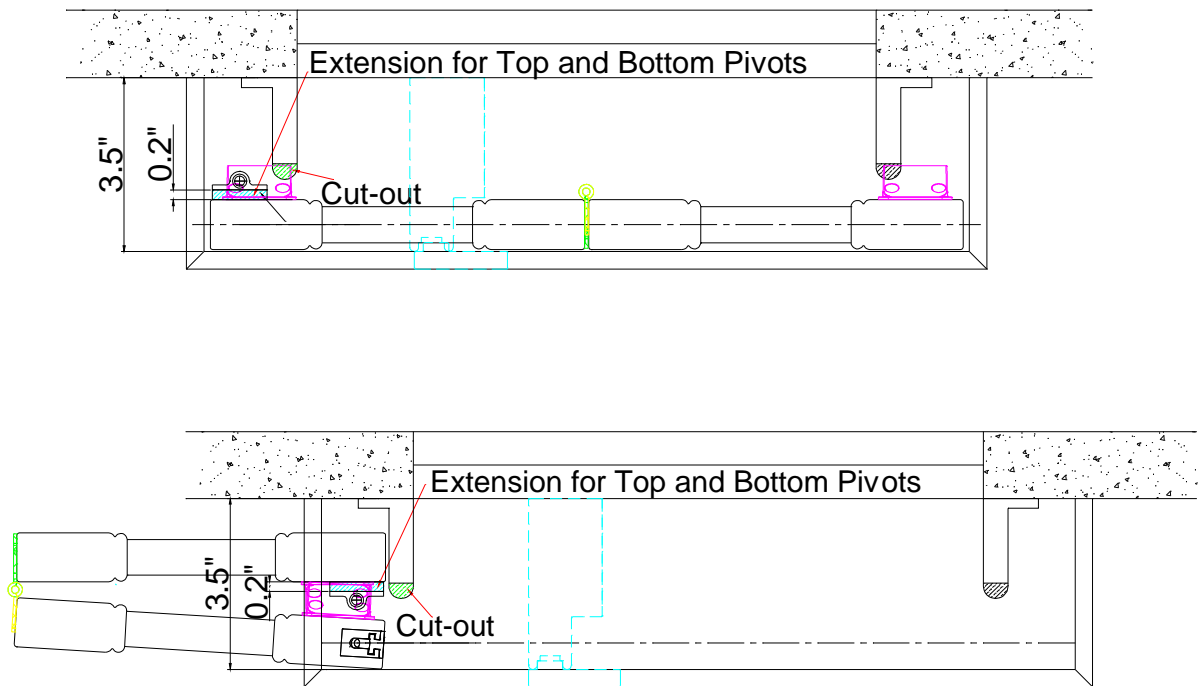



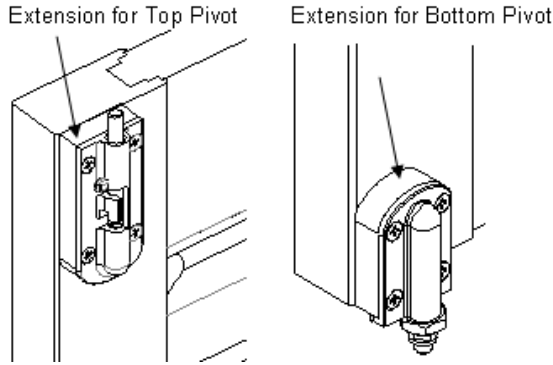

- 3) For Motorized shutter with EITHER ONE Solar Panel OR ONE Battery Expansion Pack attached to the back of the module, the L Shape Light Block will be cut out to avoid the conflict;

Available options:

- a. One Solar Panel;
  - b. One Expansion Battery Pack.
- 4) It is not recommended to have solar panels for the leftmost or rightmost panel due to the lack of sunlight.

**Module Location:** (Easy Tilt will be on the same side as the module)

**For regular shutter and bi-fold Application (Except for 2014 bifold track):**

- 1) Single Panel: Module will be on the un-hinge stile
- 2) 2 Panels: LL, LR, RR

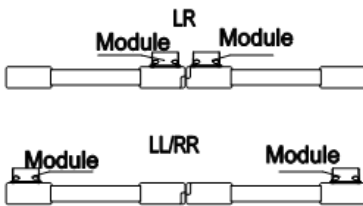

- 3) 3 Panels: LLL/RRR

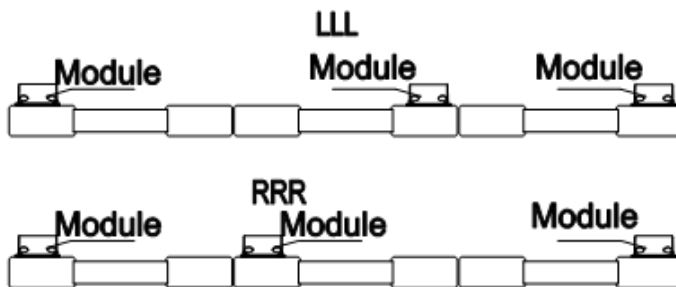

4) 4 Panels: LLRR/LLLL/RRRR



**For 90° and 180° Bifold Track:**

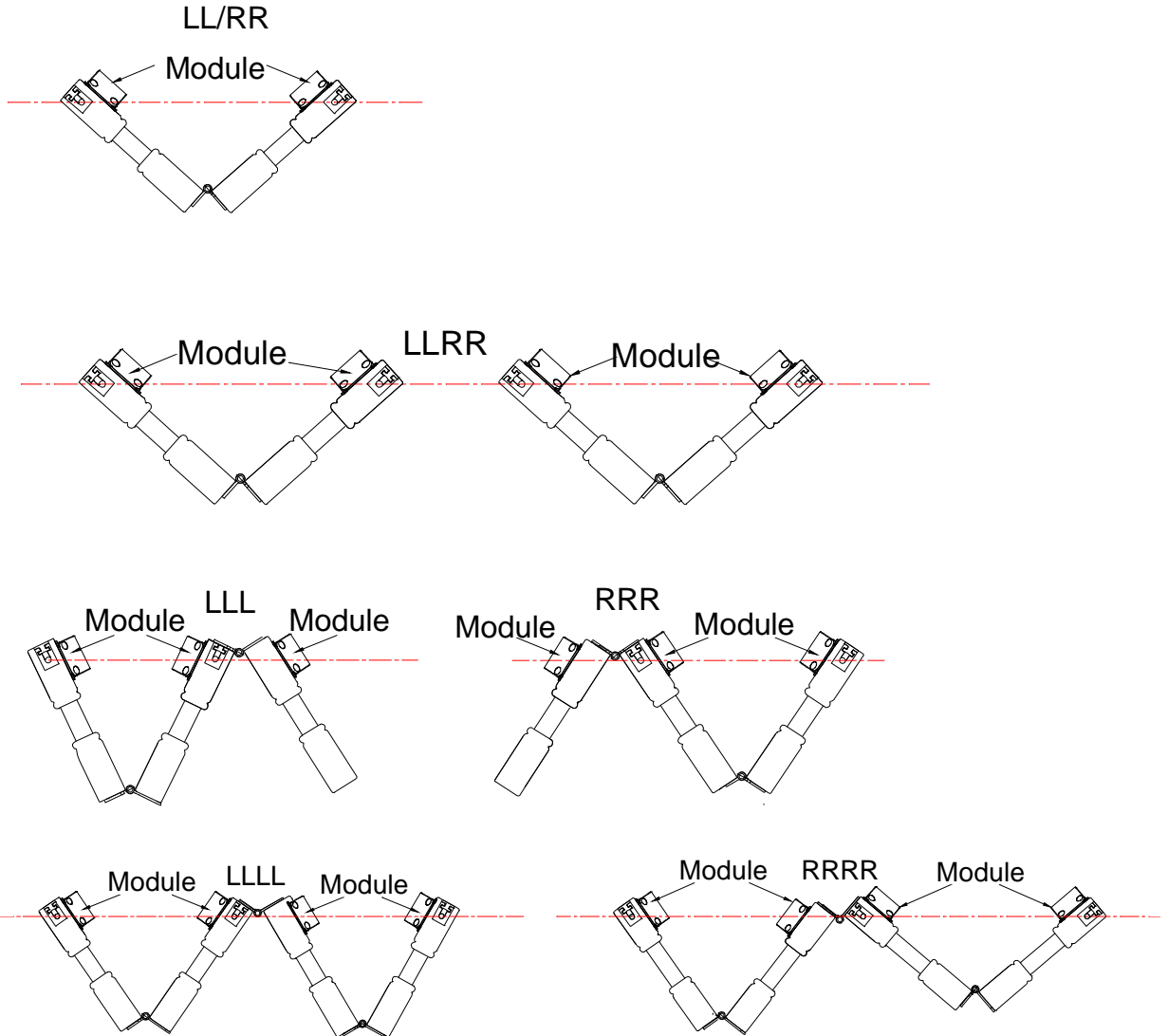

**Special Note on Bi-fold or Multi-fold Configurations**

Please be aware that in bi-fold or multi-fold configurations of RF, the motorization modules will touch each other when the panels are folded together, so the panels can't be able to stack together as tightly as that of the non-motorized shutters.

Additionally, before folding the bi-fold or multi-fold panels together, please ensure that the louvers are returned to a completely closed position (either up or down) to prevent louver damage when folding panels.

For Fold panels, the module installation will be staggered by default for better fold; it is

optional to line up the modules for bi-fold/multi-fold shutter;

However, for 180° bifold track shutter, the modules can only be staggered.

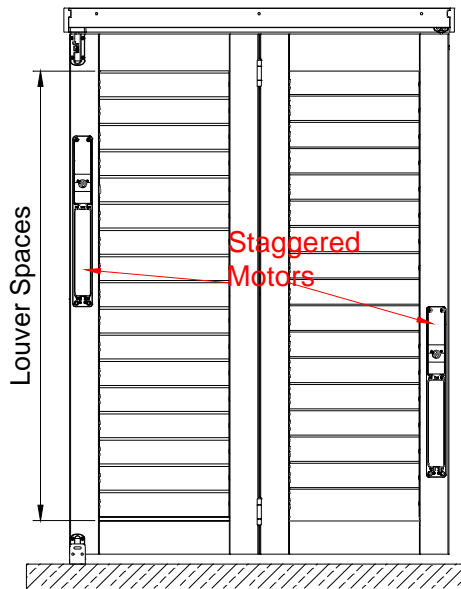

**For By-Pass Application**

**2 Panels Side Open**

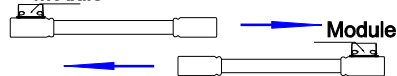

**3 Panels Center Open (Not available for Open Bypass)**

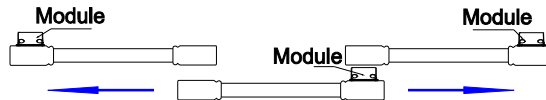

**4 Panels Center Open**

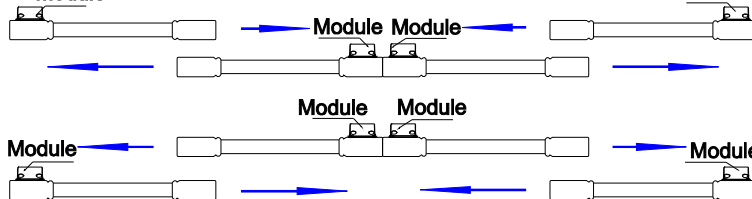

**4 Panels Side Open**

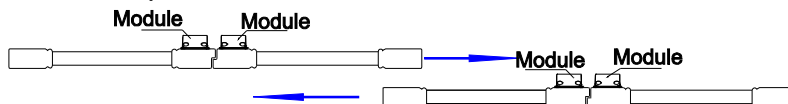

**For Special Shape Application:**

Module location will be the same as the Invisible Tilt location.

**Built-in Timer Function:**

The Timer function is now available for remote unit that were shipped on and after June 1st, 2013. Please see below for Website link and follow the User Guide to set up the timer schedule for the remote.

Perfect Tilt RF e-Timer website:

[www.windowcoveringsautomation.com:9000/](http://www.windowcoveringsautomation.com:9000/)

The following is how to distinguish the remote with and without timer function:

	Original Remote	New Remote w/ Timer
Timer Off Light Color	Red	Orange
PN Number	not available	located beneath the back cover

**Warranty**

The warranty for the Module and the Remote Control Unit is 2-year under normal operation.

**SHUTTER LOOK FROM FRONT AND BACK**

The front side of the shutter



\*No Receiver/Louver Cap

\*Easy Tilt Only

The back of the shutter



\*The light block would be cut out along the module.

\*The battery cover of the module would come with a wood cover And the color of the wood cover will match that of the shutter.



## HOW TO MANUALLY OPERATE THE LOUVERS

At the back of the motor, there is an “M” and “R” which is a remote switch.

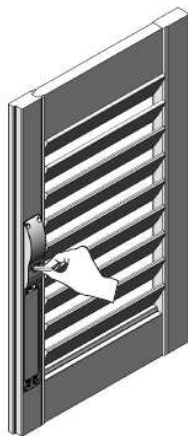

\*Turn to M to manually operate the louvers and turn to R to use your remote to operate the shutter.

Note: Forcing the louvers to rotate without turning to M will cause serious damage to your PerfectTilt® RF system.

## **HOW TO USE THE EXPANSION BATTERY PACK**

Expansion Battery Pack is to provide longer operation time of shutter.

Remove the battery cover and wood cover, and fix the Expansion Battery Pack to the module. More can be added if the space allows.



\*Expansion Battery Pack can be attached to the module

\*Make sure to use same type batteries in both the module and the Expansion Battery Pack.

## HOW TO USE THE SOLAR PANEL



\* Make sure rechargeable batteries are used in the module or the Expansion Battery Pack when using with Solar Panel

\*Solar Panel Position:

a. Attached to the back of the module or the Expansion Battery Pack

b. Installed on the rail (Optional with surcharge) factory will prewire and install the mounting base.

For panels with modules below the mid rail or panels without mid rail, the solar panel will be attached to the bottom rail;

For panels with modules above mid rail, the solar panel will be attached to the top rail.



If Expansion Battery Pack or Solar Panel is to fix on the module, please keep the wood cover and in the future if the expansion battery pack or the solar panel is not needed, the wood cover can be put back in use.

## HOW TO FIX LOUVERS THAT ARE OUT OF POSITION

Firstly find out the louver out of position;



Next please grab three louvers above or below the louver in different position. Then grab the louver out of position and tilt it up/down to put the louver back to the correct position.



## HOW TO REPLACE THE MODULE

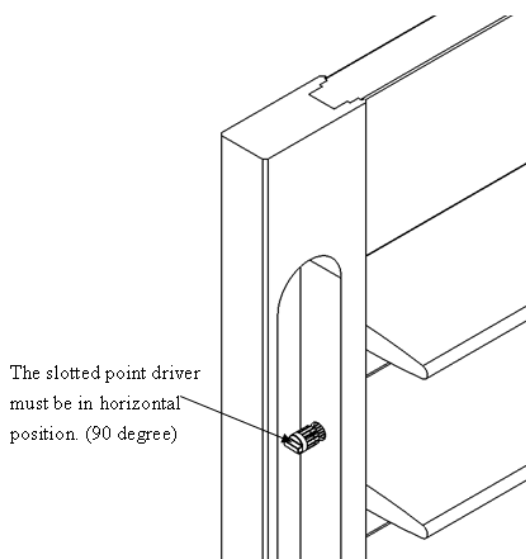

\*The module can be taken out of the stile when the louver as well as the slotted point driver is in horizontal position.

\*The customer could also fix the module into the stile when the louver as well as the slotted point driver is in horizontal position.



## HOW TO REPLACE BATTERY FOR THE MODULE

To install batteries to the open the battery cover. Remove the battery cartridge. Insert batteries (AA batteries \*6) matching the (+) and (-) marks inside the battery cartridge. Put back the cartridge and reinstall the battery cover.

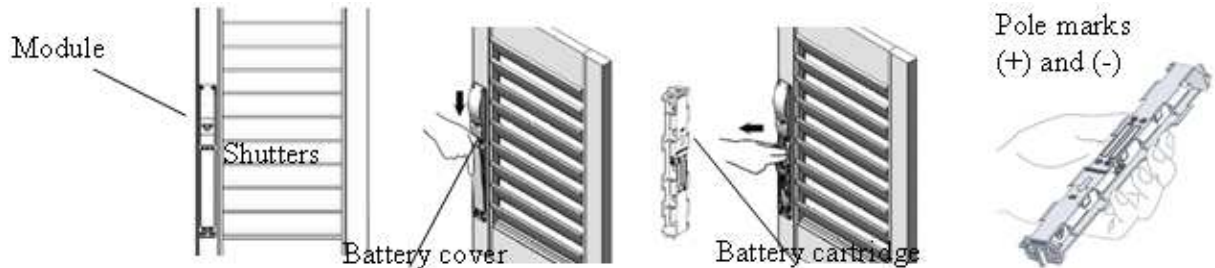

## HOW TO USE THE REMOTE CONTROL

### Remote Control Buttons and Indicators

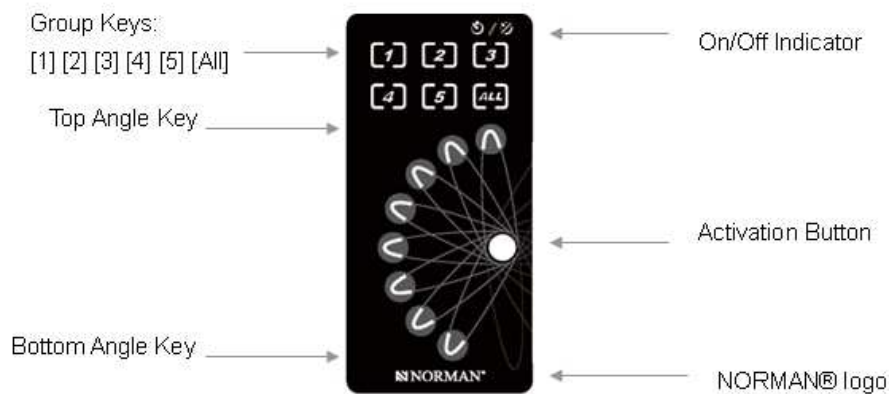

### USB Port (Timer Function)

#### Norman Logo Light:

Light on = Remote Control ready

Light off = Remote Control in sleep mode

### 8 Preset Louver Positions

Each of the “Angle” keys corresponds to a desired tilting position, spanning the entire arc of the louver’s movement

**Group keys “1” through “5” and “All” key**

The keys “1” through “5” control shutter modules grouped in “1” to “5” groups, each group can consist of unlimited numbers of shutters that are in range.

The “All” key controls shutter modules in all groups at once.

**HOW TO REPLACE BATTERY FOR REMOTE CONTROL**

The remote control requires 2 AAA batteries. To install the batteries, turn over the remote and open the cover. Insert batteries (AAA batteries \* 2) matching the (+) and (-) marks and cover the bottom cover. If the battery has been properly installed, the NORMAN® logo will light up.

