



Upgrade to the industry's most advanced Motor Program:
AMP™ Motorization features 2-way technology with superior value and innovation paired with a smart, seamless user interface.



AMP Drapery-1.2/120

Programming Guide

Specifications

- 1.2Nm DC motor for Drapery
- 3 motor speed settings: 80, 100, or 120rpm
- Auto set limits and manual activation
- Soft start and soft stop feature for smooth performance
- Compatible with Kirsch® Estate™ & Architrac® track systems



AMP™ Motorization Table of Contents

Declarations	3
Safety Instructions	4
AMP™ Drapery-1.2/120 Overview	5
P1 Button Instructions	6
AMP™ Remote Overview	7
Initial Set-up	9
Adjust Limits	10
Favorite Position	11
Add or Remove Additional Remote	12
Adjust Motor Speed	13
Manual Override Function	14
Quick Index	15
Troubleshooting	15



Please scan QR code to watch videos
for product programming



Declarations

U.S. Radio Frequency FCC Compliance

This device complies with Part 15 of the FCC Rules. Operation is subject to the following two conditions:

- (1) This device may not cause harmful interference, and
- (2) This device must accept any interference received, including interference that may cause undesired operation.

This equipment has been tested and found to comply with the limits for a Class B digital device, pursuant to Part 15 of the FCC Rules. These limits are designed to provide reasonable protection against harmful interference in a residential installation. This equipment generates, uses, and can radiate radio frequency energy and, if not installed and used in accordance with the instructions, may cause harmful interference to radio communications. However, there is no guarantee that interference will not occur in a particular installation. If this equipment does cause harmful interference to radio or television reception, which can be determined by turning the equipment off and on, the user is encouraged to try to correct the interference by one or more of the following measures:

- Reorient or relocate the receiving antenna.
- Increase the separation between the equipment and receiver.
- Connect the equipment into an outlet on a circuit different from that to which the receiver is connected.
- Consult the dealer or an experienced radio/TV technician for help.

Any Changes or modifications not expressly approved by the party responsible for compliance could void the user's authority to operate the equipment.

ISED RSS Warning:

This device complies with Innovation, Science and Economic Development Canada license-exempt RSS standard(s). Operation is subject to the following two conditions: (1) this device may not cause interference, and (2) this device must accept any interference, including interference that may cause undesired operation of the device. Le présent appareil est conforme aux CNR d'ISED applicables aux appareils radio exempts de licence. L'exploitation est autorisée aux deux conditions suivantes: (1) l'appareil ne doit pas produire de brouillage, et (2) l'utilisateur de l'appareil doit accepter tout brouillage radioélectrique subi, même si le brouillage est susceptible d'en compromettre le fonctionnement.

Safety Instructions

Attention

Never drop, knock, drill or submerge the motor. Keep the power cable in the proper position as shown below.

Read all safety instructions before installation.

Incorrect installation can lead to serious injury and will void manufacturer's liability and warranty.

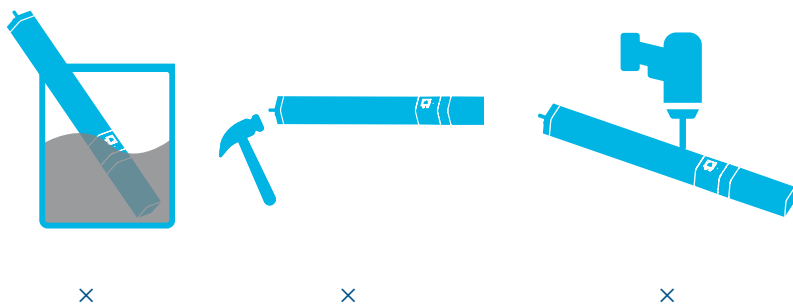

Important Safety Instructions

1. Do not expose motor to humid, damp, or extreme temperature conditions.
2. Do not drill into motor.
3. Do not cut the antenna. Keep it clear from metal objects.
4. Do not allow children to play with this device.
5. If the power cable or connector is damaged, do not use.
6. Ensure the correct crown and drive adaptor are used.
7. Ensure the power cable and aerial is clear and protected from moving parts.
8. Cable routed through walls should be properly isolated.
9. Motor is to be mounted in horizontal position only.
10. Before installation, remove unnecessary cords and disable equipment not needed for powered operation.
11. Installation and programming should be performed by a qualified professional. Use or modification outside the scope of these instructions may void warranty.



Do not dispose of in general waste.

Please recycle batteries and damaged electrical products appropriately.

AMPDraperY-1.2/120 Overview

1. Fields of Application

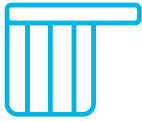

One-Way
Left Stack

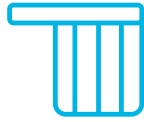

One-Way
Right Stack

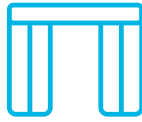

Two-Way
Split Stack

2. Motor Head Button Instructions

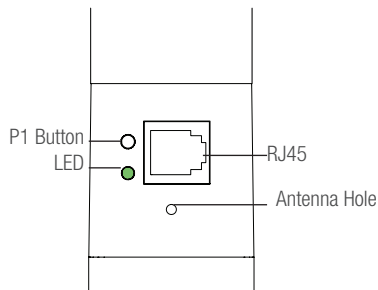

3. Charging Instructions

This motor has a built in Li-ion battery pack with integrated charge management.
Max power input for recharging: 5V 2A.



- Before first use please charge motor for 6 hours.
- During operation, when the motor starts, the buzzer will beep 5 times and the LED will flash 5 times, indicating a low-voltage alarm and needs to be charged.
- During operation, if the voltage is detected to be too low, the battery stops running and needs to be recharged.

Rechargeable Battery Status Indicator

The battery charger has LED indicator to show the charging status:



Solid red:
Charging in process



Solid green:
Battery has finished
charging

P1 Button Instructions

① Test Motor

Happening as you press for 1 second



Press P1
Less than 1 sec.

when released

Motor Response: Wakes & Runs

② Activate Pairing Mode

Happening as you press for 2 seconds



Press P1
Approx. 2 sec.

Until Shade:  LED Flash x1

when released

Motor Response:  Beep x1

③ Sleep Mode

Happening as you press for 6 seconds



Press P1
Approx. 6 sec.

Until Shade:  LED Flash x2

when released

Motor Response:  Beep x2

④ Enter Setting Mode

Happening as you press for 10 seconds



Press P1
Approx. 10 sec.

Until Shade:  LED Flash x3

when released

Motor Response:  Beep x3

⑤ Reset To Factory Settings

Happening as you press for 14 seconds



Press P1
Approx. 14 sec.

Until Shade:  LED Flash x4

when released

Motor Response:  Beep x4

1. Remote Button Instructions

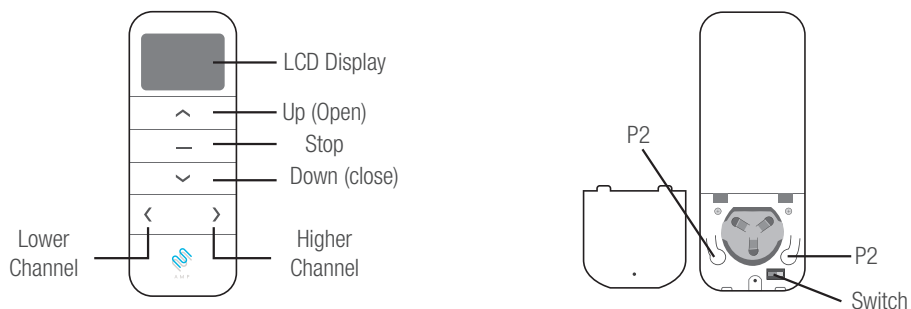

2. Replace/Install CR2450 Battery

- Gently insert the included ejector tool into the small pinhole opening and apply a small amount of pressure to the cover and slide the cover off.
- Install battery (CR2450) with positive (+) side facing up.
- Gently slide the cover back on until a “click” sound is heard.

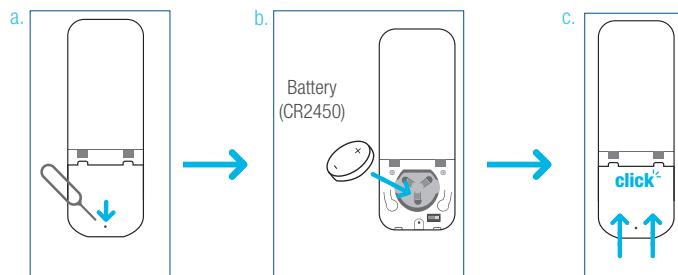

3. Channel Options

Select A Channel

- Press “<” button on the remote to select a lower channel.
- Press “>” button on the remote to select a higher channel.

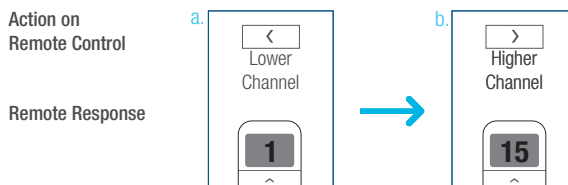

Hide Unused Channels

- Press and Hold (about 3 sec) “<” and “>” buttons simultaneously until remote control displays “C” (channel).
- Press “<” or “>” button to select required quantity of channel (between 1 to 15).
- Press “Stop” button to confirm selection (the example shows a 5-channel selection). The LED will display “0” (OK) once to confirm selection.

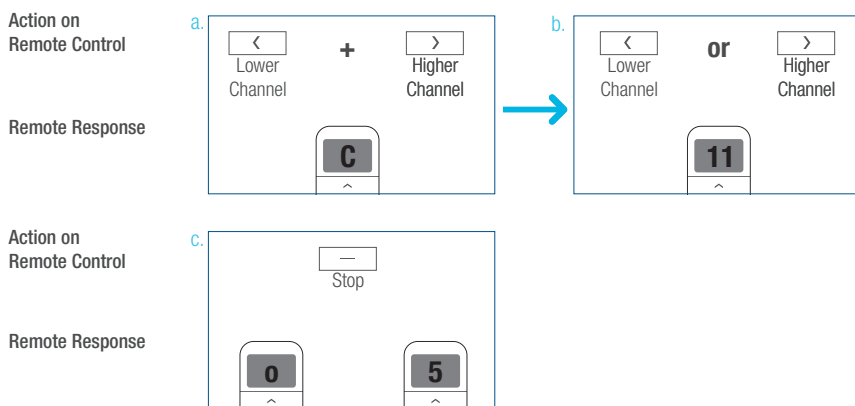

4. Advanced Setting - Disable Limit Setting

a. Remove the cover from the backside of remote, the lock switch is in the right corner.

b. Move the switch to the **“Lock”** position to disable the following commands, remote will show **“L”** (lock):

- Change Motor Direction
- Setting the Upper and Lower Limit
- Adjust Limit
- Roller Mode or Sheer Mode

c. Move the switch to **“Unlock”** position to assess all remote functions, remote will show **“U”** (unlock).

*This advanced feature is intended to be used after all shade programming is completed. User Mode will prevent accidental or unintended changing of limits.

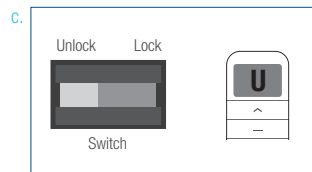
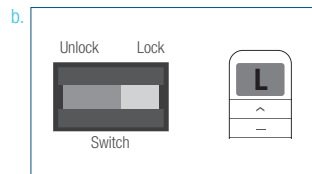
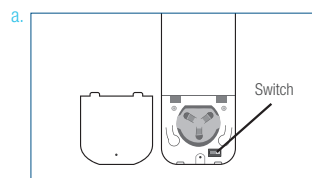

Initial Set-up

1. Pair / Unpair Remote Control

- Press **“P1”** button (about 2 sec) on the motor head until motor LED flash x1 and beep x1.
- In the next 10 secs, press and hold **“Stop”** button on the remote control until motor LED flash x5 and beep x3.

Action on Motor

Motor Response

Action on Remote Control

Motor Response

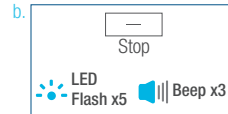
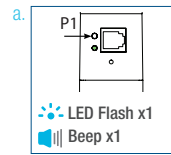

* Repeat the same procedure to unpair remote control.

2. Change Motor Direction (if necessary)

Press **“Up”** or **“Down”** button to check if the drapery moves in the desired direction.

If you need to reverse the direction, press and hold (about 2 sec) **“Up”** and **“Down”** buttons simultaneously until motor LED flash x3 and beep x3.

Action on Remote Control

Motor Response

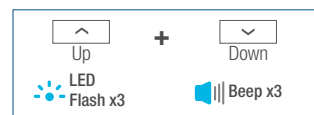

Notes:

- The operation is only valid when there are no limits. If the motor has already set the limits, then you can only switch direction by pressing P1 button (See P1 button instructions) to enter Setting mode.
- Changing motor direction with limits already set will clear the limits.
- Open and close the Drapery to re-set the limits automatically.

3. Set Auto Limits

AMP Drapery motor has auto limit detection feature. Once the motor is attached to a installed track, limits can be set with a few simple actions.

3.1 Set the Limits

- Press **“Up”** buttons for the carriers to run to the end of the track. When carriers reach the end of the track, the limit will automatically set there.
- Press **“Up”** or **“Down”** buttons for the carriers to run to the opposite end. The motor LED flash x5 and Beep x3 confirms limit auto set.

Action on Remote Control

Motor Response

Action on Remote Control

Motor Response

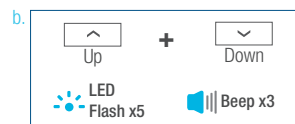
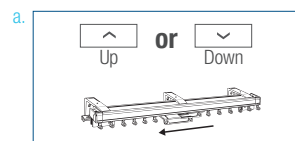

3.2 Delete the limits

- Press one **“P2”** button on the back of remote control until motor LED flash x1 and beep x1.
- Press **“Down”** button until motor LED flash x1 and beep x1.
- Press one **“P2”** button until motor LED flash x5 and beep x3.

Action on Remote Control

Motor Response

Action on Remote Control

Motor Response

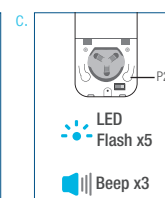
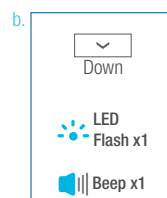
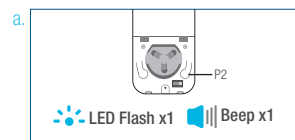

Notes:

- After the limit sets, initial set-up is now complete.
- After the limit sets, if the motor encounters a new obstacle a maximum of 3 times at the same position, the limit will automatically reset.

Factory Mode Complete
User Mode Begins

Adjust Limits

1. Adjust the Open Limit

a. Press and hold (about 5 sec) **“Up”** and **“Stop”** buttons simultaneously until motor LED flash x1 and beep x1.

b. Press **“Up”** or **“Down”** buttons or hand pull to move Drapery to the desired open position.

c. Press and hold (about 5 sec) **“Up”** and **“Stop”** buttons simultaneously until motor LED flash x5 and beep x3.

Action on Remote Control

Motor Response

Action on Remote Control

Motor Response

Action on Remote Control

Motor Response

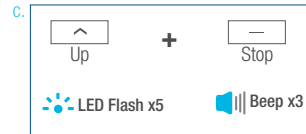
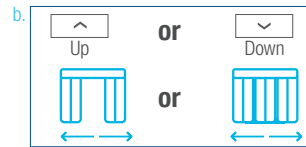
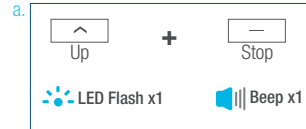

2. Adjust the Close Limit

a. Press and hold (about 5 sec) **“Down”** and **“Stop”** buttons simultaneously until motor LED flash x1 and beep x1.

b. Press **“Up”** or **“Down”** buttons or hand pull to move Drapery to the desired closed position.

c. Press and hold (about 5 sec) **“Down”** and **“Stop”** buttons simultaneously until motor LED flash x5 and beep x3.

Action on Remote Control

Motor Response

Action on Remote Control

Motor Response

Action on Remote Control

Motor Response

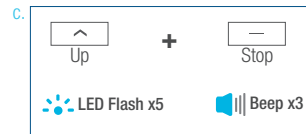
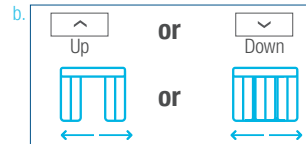
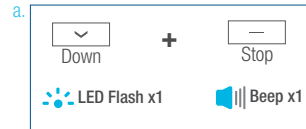

Favorite Position

1. Set Favorite Position

- a. Use **“Up”** or **“Down”** button to move the drapery to desired Favorite position.
- b. Press one **“P2”** button on the back of remote control until motor LED flash x1 and beep x1.
- c. Press **“Stop”** button until motor LED flash x1 and beep x1.
- d. Once more, press and hold **“Stop”** button until motor LED flash x5 and beep x3.

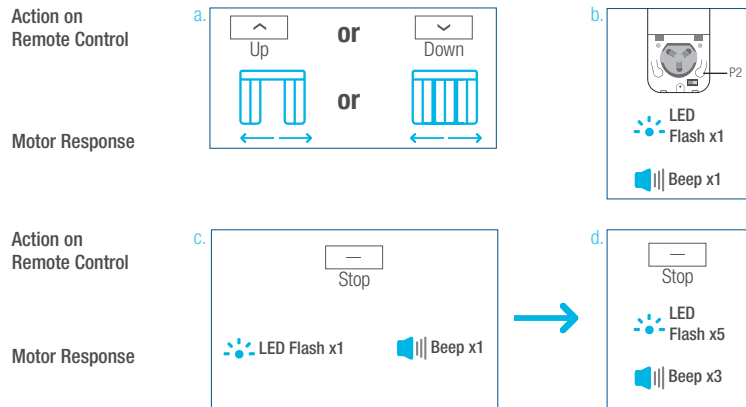

2. Send Drapery to Favorite Position

Press and hold (about 2 sec) **“Stop”** button, motor will send the drapery to Favorite position.

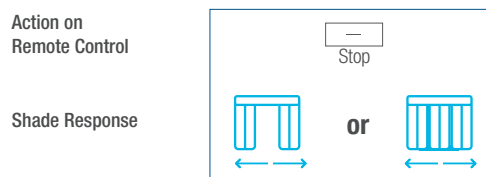

3. Delete Favorite Position

- a. Press one **“P2”** button until motor LED flash and beep x1.
- b. Press **“Stop”** button until motor LED flash and beep x1.
- c. Once more, press **“Stop”** button until motor LED flash x1 and beep x3.

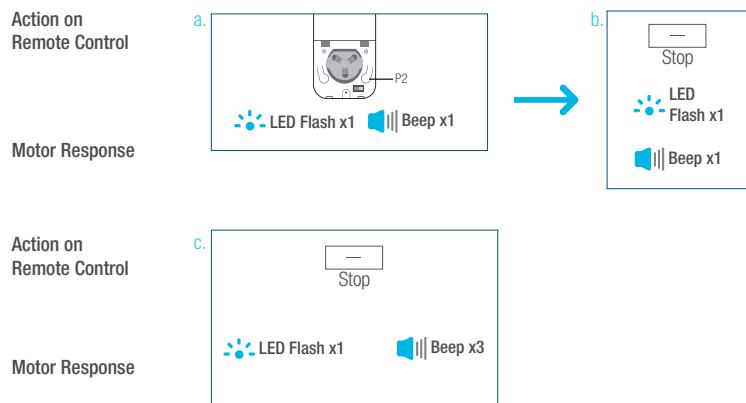

Add or Remove Additional Remote

1. Using Current Remote Control

a. On the **current** remote control, press one “P2” button until motor LED flash x1 and beep x1.

b. Once more, on the **current** remote control, press one “P2” button until motor LED flash x1 and beep x1.

c. On the **New** remote control, press one “P2” button until motor LED flash x5 and beep x3.

*Repeat the same procedure to remove additional remote control.

Action on Remote Control

Motor Response

Action on Remote Control

Motor Response

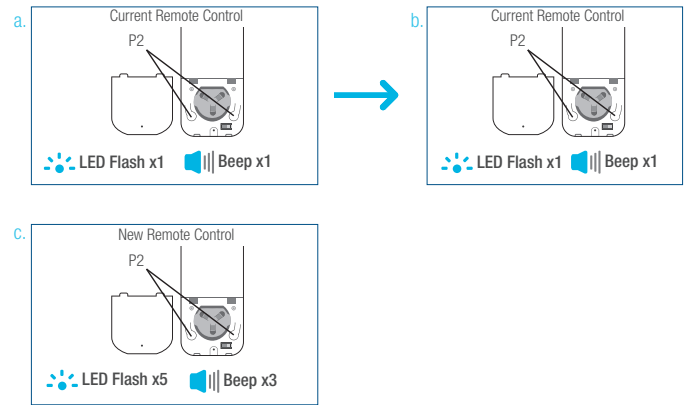

2. New Remote Control

Follow instructions on page 9 under the section **Pair / Unpair Remote Control**

Adjust Motor Speed

1. Acceleration Speed

- a. Press one “P2” button until motor LED flash x1 and beep x1.
- b. Press “Up” button until motor LED flash x1 and beep x1.
- c. Once more, press “Up” button until motor LED flash x5 and beep x1.

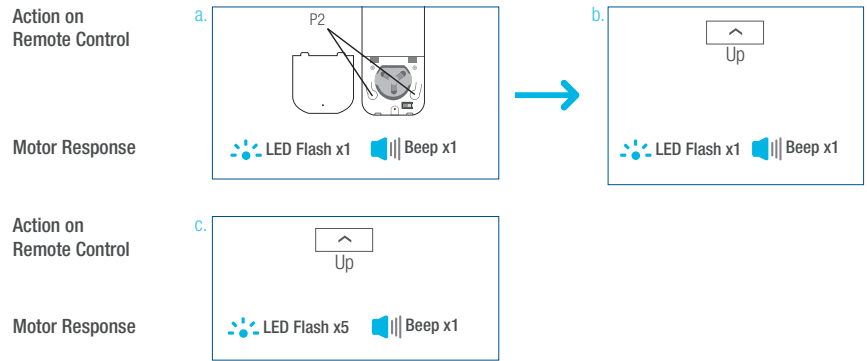

2. Deceleration Speed

- a. Press one “P2” button until motor LED flash x1 and beep x1.
- b. Press “Down” button until motor LED flash x1 and beep x1.
- c. Once more, press “Down” button until motor LED flash x5 and beep x1.

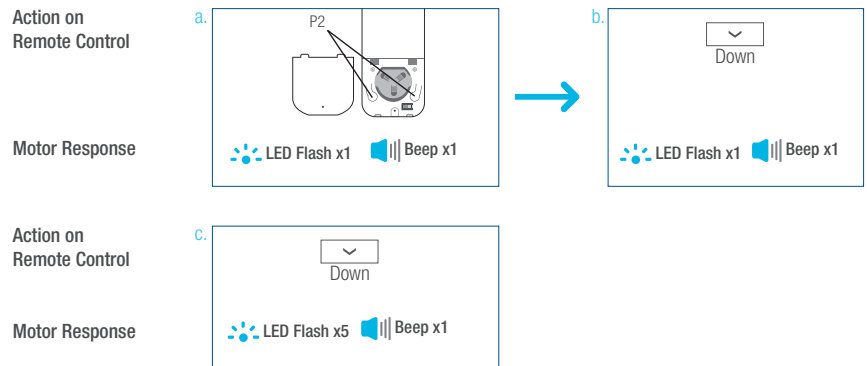

Notes:

- AMPDrapery Motor has 3 speeds: 80, 100 and 120RPM; If the motor has no response, it already has a Maximum or Minimum speed.
- When the limits are not set, the default speed is minimum speed 80rpm.
- After the limits are set, the default speed is MAXIMUM speed 120rpm.

Manual Override Function

AMP™ Drapery Motor has a built-in function which enables the motor to be initiated by hand-draw. When the fabric is displaced more than 10cm by hand-draw, the motor continues to move towards the drawn direction, until the limit is reached.

The manual override function is default and can be turned off.

1. Operation with Manual Override Function

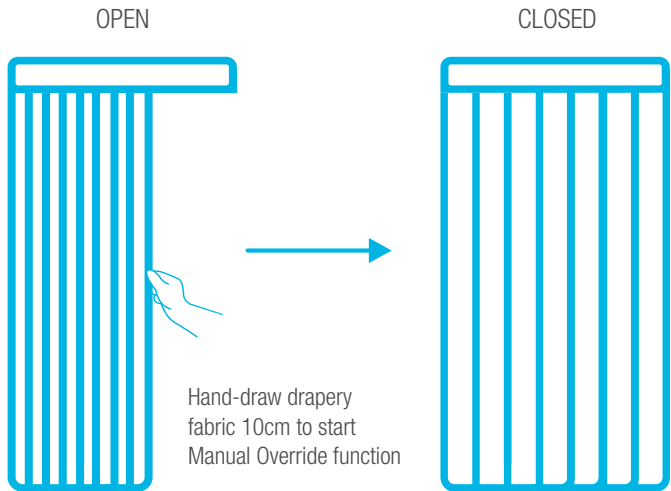

2. Turn On/Off Manual Override Function

a. Press **“P1” button** (about 10 sec) on the motor head until motor LED flash x3 and beep x3.

b. Press and hold **“Stop”** button on the remote control until motor LED flash x5 and beep x3.

*Repeat the same procedure to turn on the manual override function.

Action on Remote Control

Motor Response

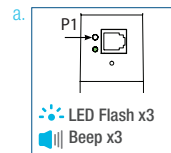

Action on Remote Control

Motor Response

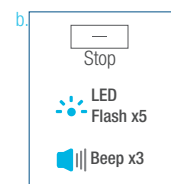

Quick Index

Settings	Steps
1 Pairing	P1 (hold down for 2s) > Stop (hold down for 2s)
2 Switch Rotating Direction	Up + Down (hold down for 2s)
3 Auto Set Limits	Press "Up" or "Down" buttons for the carriers to run to the end of the track. Repeat for opposite end.
4 Add / Remove Favorite Position	P2 > Stop > Stop
5 Adjust Limits	Open Limit: Up + Stop (hold down for 5s) > Up or Down > Up + Stop (hold down for 2s) Close Limit: Down + Stop (hold down for 5s) > Up or Down > Down + Stop (hold down for 2s)
6 Pair/Unpair Additional Emitter	P2 (existing) > P2 (existing) > P2 (new)
7 Speed Regulation	Acceleration: P2 > Up > Up Deceleration: P2 > Down > Down

Troubleshooting

Issues	Possible Causes	Solution
The motor has no response	External Battery Pack is depleted	Recharge with compatible AC adapter
	Remote control battery is discharged	Replace battery
	Battery is inserted incorrectly into remote control	Check batter polarity
	Receiver is far away from remote control	Move remote control to a closer position
	Power failure	Check power supply to motor is connected and active
	Incorrect wiring	Check that wiring is connected correctly (refer to motor installation instructions)
Motor Beeps + LED Flash 5 times when in use	Battery voltage is low	Recharge with AC adapter
Cannot program a single motor (multiple motors respond)	Multiple motors are paired to the same channel.	Always reserve an individual channel for programming functions
		SYSTEM BEST PRACTICE - Provide an extra 15 channel remote in your multi-motor projects that provides individual control for each motor for programming purposes
		Place all other motors into sleep mode (ref to P1 button instructions)

Need assistance with your AMP™ Motor?

If you are an end-user, please contact your installer or dealer.

If you are a dealer or distributor, for specialized AMP Technical Support, please contact us by phone at (800) 252-2512 or by email at amp@turnils.com.

Turnils Contact Information

Turnils North America

1750 Satellite Blvd, Suite 100
 Buford, GA 30518
 1-800-341-3600
Amp@Turnils.com

Turnils Canada

2908 Portland Drive
 Oakville, Ontario L6H 5W8
 1-800-341-3600
Amp@Turnils.com