



By Ormesa



201 Growth Parkway Angola, IN 46703

U. S. Suggested Retail Price List

Phone: 260-665-2769

Jan-18

Fax: 260-665-3047

Email: iim@mobility-usa.com

[www.mobility-usa.com](http://www.mobility-usa.com)

Quote: \_\_\_\_\_

P.O. \_\_\_\_\_

**Bill To**

Dealer: \_\_\_\_\_ Contact: \_\_\_\_\_

Address: \_\_\_\_\_

City: \_\_\_\_\_ State: \_\_\_\_\_ Zip: \_\_\_\_\_

Phone: \_\_\_\_\_ Fax: \_\_\_\_\_

Email: \_\_\_\_\_ Mark For: \_\_\_\_\_

**Ship To Same as Bill To \_\_\_\_\_**

Dealer: \_\_\_\_\_ Contact: \_\_\_\_\_

Address: \_\_\_\_\_

City: \_\_\_\_\_ State: \_\_\_\_\_ Zip: \_\_\_\_\_

Phone: \_\_\_\_\_ Fax: \_\_\_\_\_

Email: \_\_\_\_\_ Mark For: \_\_\_\_\_

**Novus Features and Specifications**

- **Frame** - foldable aluminum, bronze painted with non-toxic epoxy bronze powders
- **Blue Upholstery** - padded, ergonomic & removable; wear, water and fire proof fabric; designed to make the change of accessories easier without causing trouble to the child while seated
- **Backrest** - adjustable in height and tilt
- **Seat Bottom** - adjustable in width and depth
- **Legrest** - adjustable in tilt, with a quick release mechanism; flip-up footrest adjustable in tilt
- **Wheels** - snap-on, sliding on ball bearings; front wheel 7" and puncture-proof rear wheel 12" with independent drum brakes

**Novus**

Part Number	Description	Price	HCPCS
____ NN-2	<b>Novus 2</b>	\$3,300.00	E1236
____ NN-3	<b>Novus 3</b>	\$3,400.00	E1236
____ NN-4	<b>Novus 4</b>	\$3,500.00	E1236











**Footrest Options**



Part Number	Description	Price	HCPCS
____ 827	<b>Foot Straps 8"-11"</b>	\$70.00	E0951
____ 827A	<b>Foot Straps 11"-14"</b>	\$80.00	E0951
____ 817-1	<b>Leg Straps 2</b>	\$135.00	K0038
____ 817-3	<b>Leg Straps 3 &amp; 4</b>	\$135.00	K0038
____ NB892-1/2	<b>Padded Footplate Covering 2</b>	\$100.00	K0108
____ NB892-3/4	<b>Padded Footplate Covering 3 &amp; 4</b>	\$100.00	K0108











**Positioning Options**

Part Number	Description	Price	HCPCS	
____ NN838-2	<b>Adjustable Lateral Supports 2</b>	\$260.00	E0956	
____ NN838-3	<b>Adjustable Lateral Supports 3</b>	\$260.00	E0956	
____ NN838-4	<b>Adjustable Lateral Supports 4</b>	\$260.00	E0956	
____ 853	<b>Vest Harness 2</b>	\$175.00	E0960	
____ 853-3	<b>Vest Harness 3 &amp; 4</b>	\$175.00	E0960	
____ 894-1	<b>45° Pelvic Belt 2</b>	\$95.00	E0978	
____ 894-3	<b>45° Pelvic Belt 3 &amp; 4</b>	\$95.00	E0978	
____ 906-1	<b>Five Point Harness 2</b>	\$130.00	E0960	
____ 906-3	<b>Five Point Harness 3 &amp; 4</b>	\$130.00	E0960	
____ NN868-2	<b>Wrappable and Flexible Trunk Supports 2</b>	\$430.00	E0956	
____ NN868-3	<b>Wrappable and Flexible Trunk Supports 3 &amp; 4</b>	\$430.00	E0956	
____ NN834-2	<b>Padded Abduction Block 2</b>	\$140.00	E0957	
____ NN834-3	<b>Padded Abduction Block 3</b>	\$140.00	E0957	
____ NN834-4	<b>Padded Abduction Block 4</b>	\$140.00	E0957	
____ NN852-2	<b>Headrest with Parietal Supports 2 &amp; 3</b>	\$290.00	E0955	
____ NN852-4	<b>Headrest with Parietal Supports 4</b>	\$290.00	E0955	
____ NN863-2	<b>Headrest with Occipital-Parietal Supports 2 &amp; 3</b> requires NN863-HW	\$290.00	E0955	
____ NN863-4	<b>Headrest with Occipital-Parietal Supports 4</b> requires NN863-HW	\$290.00	E0955	
____ NN863-HW	<b>Headrest Hardware</b>	\$265.00	E1028	

**Accessories**

Part Number	Description	Price	HCPCS	
____ NN812	<b>Wheel directional locks</b>	\$160.00	K0108	
____ 818	<b>Black Thermal Cover 2</b>	\$375.00	K0108	
____ 818-3	<b>Black Thermal Cover 3 &amp; 4</b>	\$375.00	K0108	
____ NN819-2	<b>Black Canopy 2</b> requires NN819-HW	\$300.00	K0108	
____ NN819-3	<b>Black Canopy 3</b> requires NN819-HW	\$300.00	K0108	
____ NN819-4	<b>Black Canopy 4</b> requires NN819-HW	\$300.00	K0108	
____ NN819-HW	<b>Canopy Hardware</b>	\$125.00	E1028	

## Accessories Continued

Part Number	Description	Price	HPCPS	
NB854-BL	Blue Umbrella	\$140.00	K0108	
NN825-2	Black Rain Cover 2 & 3 requires 819	\$175.00	K0108	
NN825-4	Black Rain Cover 4 requires 819	\$175.00	K0108	
NN839-2	Front Handle 2	\$260.00	K0108	
NN839-3	Front Handle 3	\$260.00	K0108	
NN839-4	Front Handle 4	\$260.00	K0108	
NN824-2	Transparent Table with Edge & Hollow 2 requires NN824-HW	\$200.00	E0950	
NN824-3	Transparent Table with Edge & Hollow 3 requires NN824-HW	\$200.00	E0950	
NN824-4	Transparent Table with Edge & Hollow 4 requires NN824-HW	\$200.00	E0950	
NN824-HW	Adjustable and Removable Table Hardware	\$150.00	E1028	
NN844	Side Protecting Covers	\$150.00	K0108	
NN905-2	Hand Brake 2	\$475.00	K0108	
NN905-3	Hand Brake 3	\$475.00	K0108	
NN905-4	Hand Brake 4	\$475.00	K0108	
858	Medical Necessity Basket Not compatible with NB927	\$125.00	K0108	
NN927-2	Vent Tray 2 Not compatible with 858	\$650.00	E1029	
NN927-3	Vent Tray 3 & 4 Not compatible with 858	\$650.00	E1029	
891	Tie Down Hooks	\$275.00	K0108	
	Intended for forward-facing transport of the pushchair in a motor vehicle. Conforms with ISO 7176/19 and ANSI RESNA WC/19.			
922	Bottle Holder	\$45.00	K0108	

**Client Measurements**

A Back height: \_\_\_\_\_ F Lower leg length: \_\_\_\_\_  
 B Chest depth: \_\_\_\_\_ G Head height: \_\_\_\_\_  
 C Chest width: \_\_\_\_\_ H Arm height: \_\_\_\_\_  
 D Seat depth: \_\_\_\_\_ Age: \_\_\_\_\_  
 E Seat width: \_\_\_\_\_ Weight: \_\_\_\_\_

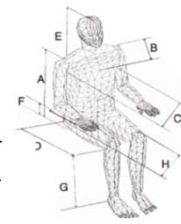

**Dimensions**

**Measurements in Inches**

Novus	Size 2	Size 3	Size 4
Max Capacity	99 lbs	121 lbs	143 lbs
User Height	49 - 57	51 - 61	57 - 66.5
Unit Weight	43 lbs	46 lbs	49 lbs
A	16	17	18
B	8 - 12	9.5 - 13	11 - 15
C	12 - 14	14 - 16	15 - 18
D	10.5 - 14.5	12 - 16	12 - 17
E	25.5 - 28	28 - 31.5	29.5 - 32
F	40.5	41.5	42
G	23.5	25	26
H	34	36.5	38
M	16	16	16.5
N	40	41	43
O	22.5	23.5	24.5
P	32.5	33	35.5

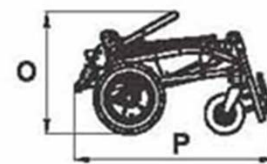
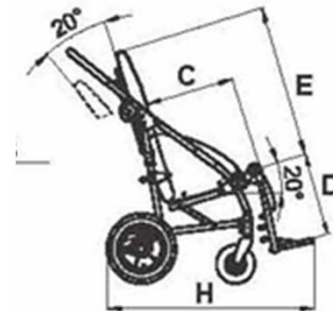
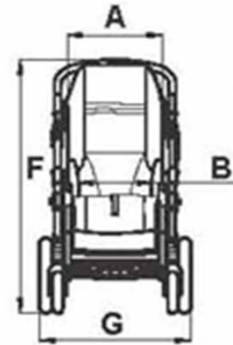

Note: All specification and prices are subject to change without notice. Prices listed are only valid if ordering with a stroller. The HCPCS codes provided are not intended to be billing or legal advice, rather Innovation In Motion's interpretation of the code definitions. Use of the codes provided does not ensure coverage or payment for the item. For coverage information, verify the policy of the appropriate payer. It is recommended to contact Innovation In Motion with any questions regarding proper ordering of the chair at 1-260-665-2769.