

# Advance smart wearable device for emergency and health monitoring using IOT

Shiva Ceetha<sup>1</sup>, Dr.R.Balaji<sup>2</sup>

*Electronics and Communication Engineering,  
B.V.Raju Institute of Technology Medak,Telangana,India  
(E-mail: shivaceetha@gmail.com)*

**Abstract**— In Medical Science, providing Intime services to patient become more challenging today,The proposed prototype tries to overcome this problem, IOT makes u more flexible for collecting data of patient,This project mainly consist of two sensor which senses the heart beat (pulse) and the body temperature. When the user wears this device, the parameters are read by the device using sensor and broadcast over the internet using NODE MCU. If the threshold levels of the sensors got raised the device sends the SMS alert to the registered number along with GPS location. This helps to find out user location with in a limited time. The most vital feature of this device, its consists of emergency button. This helps the user send his/her location to registered numbers, if the user got kidnapped.

**Keywords**— GPS , bio-Sensors, NodeMCU,IOT.

## I. Introduction

Internet of things palys a major role in health monitoring now-a-days, health issues arises very common & more difficult to control the diseases. In order to overcome health problems IOT uses patient data collection over the smart devices, the data may be stored in cloud server. Local physician can check the patient data in anywhere with smart devices, Internet of things can connect device of anyone at anytime & any place to monitor or control the applications. Generally patient data can be stored in cloud that can be monitored by doctor, family members, e-services but in emergency situation patient not getting in time services.locating patient in necessity situation is getting so difficulty.

IOT is able to connect smart devices to communicate over cloud services & capable of storing, computing data of embedded products .The applications required repeatability, coverage, user involvement. The data is collected through sensors and transferred to cloud services & control through actuators in industrial purposes. The main components used in IOT technology is Sensors as inputs, Actuators as outputs, network protocols used for data transmission over cloud storage to pcs. The efficiency of embedded applications increased by IOT especially in real time tasks the application controls through cloud data to meet dead time of embedded applications.

From an operational point of view, it is valuable to consider how IoT gadgets associate and convey as far as their specialized correspondence models. In March 2015, the Internet Architecture Board (IAB) released an overseeing

building document for frameworks organization of splendid articles (RFC 7452), 39 which plots a structure of four general correspondence models used by IoT contraptions. The discussion underneath presents this structure and clears up key characteristics of each model in the system.The contraption to-device correspondence indicate addresses no less than two devices that direct interface and give between each other, rather than through a center individual application server. These devices pass on finished various sorts of frameworks, including IP frameworks or the Internet.



Figure1: Datatransmissionthroughgadgets

These gadget to-gadget systems permit gadgets that hold fast to a specific correspondence convention to convey and trade messages to accomplish their capacity. This correspondence demonstrate is regularly utilized as a part of utilizations like home mechanization frameworks, which normally utilize little information parcels of data to convey between gadgets with generally low information rate necessities. The user may choose particular gadgets which connects to compatible protocols for example for gadgets using z-wave protocol not compatible with zigbee family gadgets.

## II. Literature Review

Data processing unit will comprise of another two separate units named as sensor unit and data transmission unit. Sensor unit will consist of Pulse sensor and temperature sensor whereas data transmission unit will consist of GPS and GSM module. The data of children vitals will be collected via sensors and then sent to the microcontroller for processing the data and finally will be delivered the information of the children health condition in form of some readable values to the smartphone of the parents or caregivers via GSM module. And this wireless feature will make this device more reliable to the parents [1].

The System tries to provide an efficient application for health care monitoring and tracking.heart beat and temperature and alsotracks of his/her locations.the measured values and the patients geographic coordintes can be sent to doctor as a short message service(sms) in case of emerginces.the system generates a map of the entire region by using the patients geographic coordinates and lists out all the nearby

doctors/hospitals for the patient.the closest doctor/hospital is found by using a distance algorithm and displayed to patient[2].

Body Sensor Network allows the integration of intelligent miniaturized low power sensor nodes in, on or around human body to monitor body functions and the surrounding Environment. it has great potential to revolutionthe future of healthcare technology and attained a number of researchers both from the academia and industry in past years.Generally,BSN consists of in-body and on-body sensor networks. An in-bodySensor network allowsinvasive/implanted devices and base station.on the other hand,an on-body Sensor network allows communication between non-invasive/wearable devices and a coordinator.

Most BSN application require accurate estimation of the patient location lack of smart tracking mechanism allows an adversary to send in correct reports about the patient location by reporting false signal strengths[3].

### III. Designing the System

#### A. Existing System:

Generally, the BSN healthcare system had a view on Data sending over server, but loacting the patient in time has very difficult to send emergency services to patient.

#### B. Proposed System:

In this project we use u-block gps tracker Should be fixed to pateint watch & we providing an emergency button to that watch, whenever patient wear the watch we can collect data of temperature, pulse & Coordinates of patient to provide in time emergency services.

Here, we can see the overview of the project in the form of block diagram as shown below

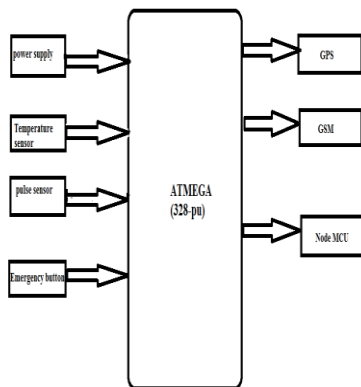

Figure 2: Block Diagram

#### C. Modules :

- (i)GPS
- (ii)GSM
- (iii)Node MCU
- (iv)Temperature sensor
- (v)Pulse sensor

#### (i)GPS:

1. The Global Positioning System (GPS) is a satellite-based route framework made up of no less than 24 satellites. GPS works in any climate conditions, anyplace on the planet, 24 hours every day, with no membership expenses or setup charges.
2. GPS satellites circle the Earth two times per day in an exact circle. Each satellite transmits a one of a kind flag and orbital parameters that enable GPS gadgets to decipher and process the exact area of the satellite.
3. GPS recipients utilize this data and trilateration to figure a client's correct area. Basically, the GPS recipient measures the separation to each satellite by the measure of time it takes to get a transmitted flag.

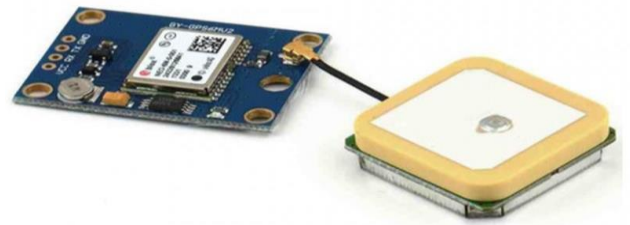

Figure 3: UBLOX GPS

#### (ii)GSM:

- GSM is a worldwide standard for cell phones. It is an acronym that stands for Global System for Mobile Communications. It is additionally now and again alluded to as 2G, as it is a second-age cell organize.
- Among different things, GSM bolsters active and approaching voice calls, Simple Message System (SMS or content informing), and information correspondence (by means of GPRS).
- Sending SMS through the GSM is done through ‘AT’ commands . Each command has unique operation.

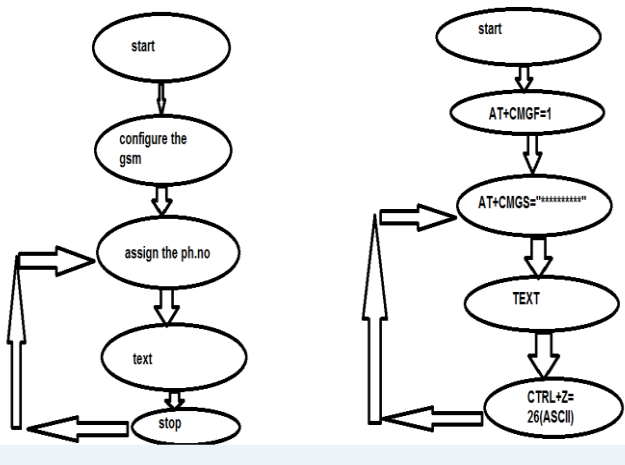

Figure 4: Flow Chart of GSM

- Essence it is an incorporated optical enhancing circuit and clamor disposing of circuit sensor.
- Clasp the Pulse Sensor to your ear cartilage or fingertip and connect it to your Arduino,you can prepared to peruse heart rate.

(VI) Hardware Setup:

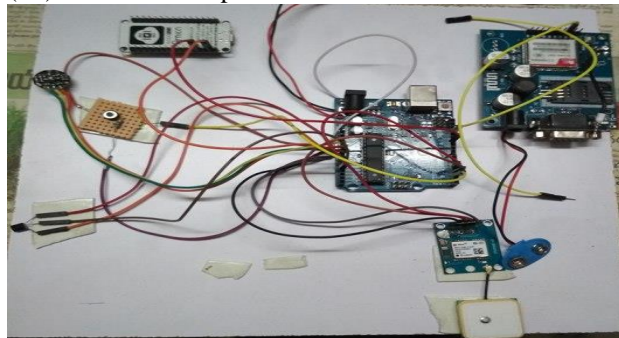

Figure 5: Hardware setup

(iii)NODE MCU:

NodeMCU is extraordinary for interfacing cloud and arduino is awesome at chatting with various sensors. Node mcu has just a single simple stick. In this blog we will perceive how to interface arduino to nodemcu and present information on amqt merchant. Arduino will take temperature readings and send the readings to nodemcu over serial association. Nodemcu will send amqt message for each understanding it gets. On the off chance that you have only one sensor to screen you can specifically utilize the simple information accessible on nodemcu, see this blog on the most proficient method to utilize the simple stick of nodemcu.

(iv)TEMPERATURE SENSOR:

- The LM35 is an ideal temperature sensor for measuring ambient temperature. It provides a linear output proportional to the temperature, with 0 V corresponding to 0 degrees C and an output voltage change of 10 mV for each one degree Celcius change.
- The output of an LM35 can be connected directly to a Arduino analog input. Because the Arduino analog-to-digital converter (ADC) has a resolution of 1024 bits, and the reference voltage is 5 V
- If the temperature of patient raises above certain value then sms alert send to doctor, family.
- The equation used to calculate the temperature from the ADC value is:

$$\text{Temp} = ((5.0 * \text{analogRead(TemperaturePin)) / 1024) * 10.0$$

(v)PULSE SENSOR:

- The Pulse Sensor is a plug-and-play heart-rate sensor for Arduino. It can be used by students, artists, athletes, makers, and game & mobile developers who want to easily incorporate live heart-rate data into their projects.

#### IV. RESULTS

1. GPS Coordinates:

The GPS of patient can be send to local doctor/family members,it will help to pateint to get in time emergency services.

The following result shows GPS coordinates send to the doctor / family phone numbers.

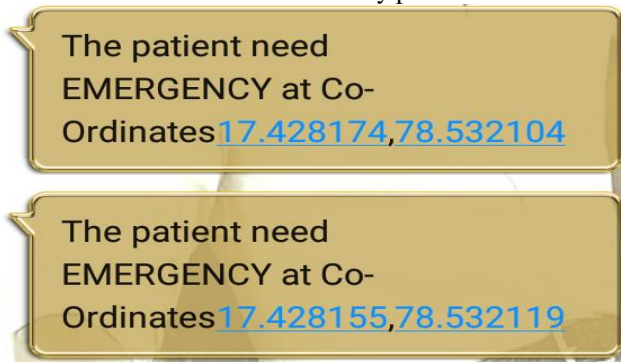
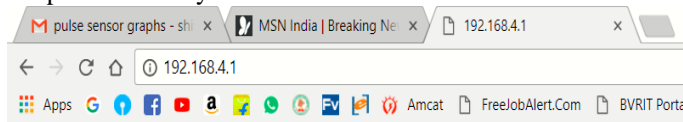

Figure 6: Gps Coordinates

2.Web page Result:

Web page is used to monitor continously of patient Data by doctor.



HEART BEAT:52 Temperature=34celsisus HEART BEAT: 115 Temperature=29celsisus

Figure 7:Web page

3. Pulse Sensor Graph:

➤ Practical values

S.no	AGE	B.P Values	Temp Values
1	20	83	98
2	23	99	98.5
3	25	114	97
4	35	115	99
5	40	118	100
6	43	119	100.5
7	45	120	96
8	50	100	97.5
9	55	95	101
10	60	135	96.5

Table 1: B.P&TempPractical Values

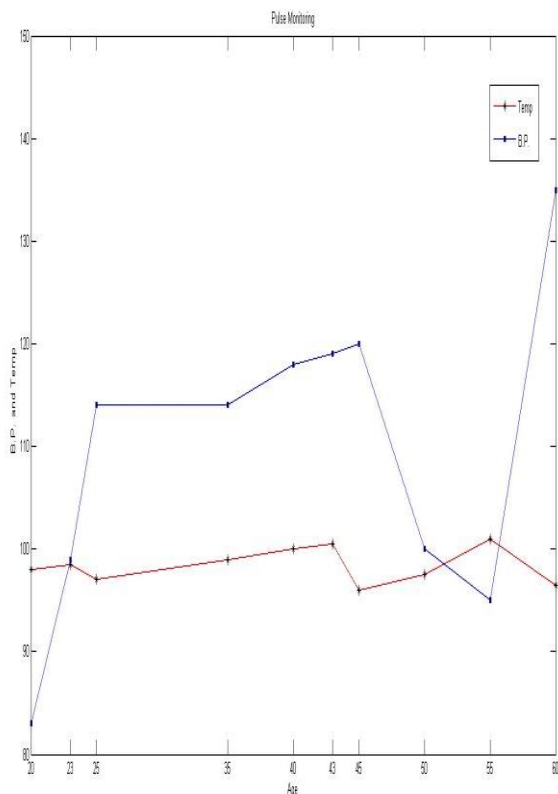

Fig 8: Pulse Monitor Graph

V. CONCLUSION

This project to identify the statistical analysis of the health data of people in the region.the development system in present work is low cost and light weight.the device is used as watch so it can be wearable by patients, if user got Kidnapped or missing location emergency button used to send location to family members.

In Future, we can Add Bio sensors helps in measuring and Analysing the different parameters such as CHOLESTRAL, SUGAR etc.In india mosquitoes are common, this is the fact for the viral diseases. So, a micro mosquito repeller is added to gadget, which helps him and others free from mosquitoes.

Acknowledgment

Authors are very much thankful to the Advanced Communication Laboratory, Department of ECE, BVRIT medak for giving us the opportunity to use the resources of the department and also the support from teeam members of ACL

References

- [1] Iftekhhar Uddin Ahmed, Nazia Hassan, Humayun Rashid “Solar Powered Smart Wearable Health Monitoring and Tracking Device Based on GPS and GSM Technology for Children with Autism”,2017
- [2]Samantak Bag,Abhijit Bhowmick “Smart healthcare monitoring and tracking system”,2017.
- [3] P. Gope, T. Hwang, “Untraceable Sensor Movement In Distributed IoT Infrastructure,” IEEE Sensors Journal, Vol. 15 (9), pp. 5340 – 5348, 2015.
- [4] Prosanto gope,Tzonelia hwang “Bsn care: A secure IoT-based modern
- [5]"Arduino - Introduction". arduino.cc.
- [6] David Kushner (2011-10-26). "The Making of Arduino".IEEE Spectrum.
- [7] JustinLahart (27 November 2009). "Taking an Open-Source Approach toHardware".The Wall Street Journal.Retrieved 2014-09-07.
- [8] HernandoBarragán (2016-01-01). "The Untold History ofArduino".Arduinohistory.github.io. Retrieved 2016-03-06.



**R.Balaji** passed out his B.E Electronics and Communication Engineering fromVelTech Engineering College, Anna university in 2009 and he is completed M.E Embedded technologies from Velammal Engineering College- Tifacore Department, Anna university in 2010. He is completed P.hd in “wireless And Sensor networks” from BundelKhand University Jhansi. He had 2yrs of teaching

Expereince & 6yrs of Industrial Expereince, 1yr of Junior Reasearch Fellowship IIT Madras(TCDE), At present he's Working as Associate Professor of "BVRIT", Narsapur, Hyderabad, Telangana.