

## Mini, Small, Medium, Large

U. S. Suggested Retail Price List  
Jan-19

Phone: 260-665-2769

Fax: 260-665-3047

Email: [iim@mobility-usa.com](mailto:iim@mobility-usa.com)

[www.mobility-usa.com](http://www.mobility-usa.com)

Quote: \_\_\_\_\_

P.O. \_\_\_\_\_

### Bill To

Dealer: \_\_\_\_\_ Contact: \_\_\_\_\_

Address: \_\_\_\_\_

City: \_\_\_\_\_ State: \_\_\_\_\_ Zip: \_\_\_\_\_

Phone: \_\_\_\_\_ Fax: \_\_\_\_\_

Email: \_\_\_\_\_ Mark For: \_\_\_\_\_

### Ship To

Same as Bill To \_\_\_\_\_

Dealer: \_\_\_\_\_ Contact: \_\_\_\_\_

Address: \_\_\_\_\_

City: \_\_\_\_\_ State: \_\_\_\_\_ Zip: \_\_\_\_\_

Phone: \_\_\_\_\_ Fax: \_\_\_\_\_

Email: \_\_\_\_\_ Mark For: \_\_\_\_\_

### Grillo Features and Specifications Mini, Small, Medium, Large

- **Quick Adjustment** - Grillo adjusts easily and tool-free for user growth, transportation, or multiple patient use.
- **Easy Transport** - In just one motion, Grillo folds into a small compact unit easy to transport. No tools required.
- **Exclusively-Designed Wheels** - Grillo wheels come standard with anti-rollback, independently adjustable tension drag, and brakes. The wheels are suitable for indoor and outdoor use.
- **Chest & Pelvic Supports** - Padded and adjustable in angle, height, inclination, and circumference. The chest and pelvic supports work independently.
- **Ergonomic Harness** - The harness supports the user if necessary without generating pressure and is breathable, adjustable, and removable.
- **Measurement Bars** - allow for quick, easy, and accurate adjustment.
- **Grillo** - has the widest range of height adjustment on the market.

### Grillo Frame Options

Part Number	Description	Price
____ GRA	<b>Grillo Frame Mini</b> requires GR824, GR930, and GR835	\$1,805.00
____ GRP	<b>Grillo Frame Mini</b> requires GR824, GR930, and GR835	\$1,805.00
____ GRA-1/2	<b>Grillo Frame Small</b> requires GRI924-1/2, GRI950, and GR835	\$1,900.00
____ GRP-1/2	<b>Grillo Frame Small</b> requires GRI924-1/2, GRI950, and GR835	\$1,900.00
____ GRA-3/4	<b>Grillo Frame Medium</b> requires GRI924-3/4 GRI950, and GR835	\$2,190.00
____ GRP-3/4	<b>Grillo Frame Medium</b> requires GRI924-3/4 GRI950, and GR835	\$2,190.00
____ GRA-5	<b>Grillo Frame Large</b> requires GRI924-5 GRI950-5, and GR835	\$2,690.00
____ GRP-5	<b>Grillo Frame Large</b> requires GRI924-5 GRI950-5, and GR835	\$2,690.00

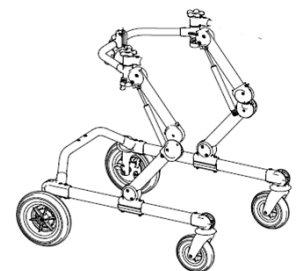

**Support Options**

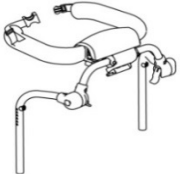
Part Number	Description	Price	
<b>MAY SELECT UP TO ONE SIZE SMALLER OR LARGER FROM FRAME SIZE</b>			
_____ GR924	<b>Pelvic Support Mn</b> each support is 11.5" long	\$600.00	
_____ GRI924-1/2	<b>Pelvic Support Sm</b> each support is 13" long	\$600.00	
_____ GRI924-3/4	<b>Pelvic Support Md</b> each support is 15" long	\$600.00	
_____ GRI924-5	<b>Pelvic Support Lg</b> each support is 18" long	\$600.00	
_____ GR930	<b>Ergonomic Harness Mn</b> 9.5" - 15.5"	\$400.00	
_____ GRI950-1/2	<b>Ergonomic Harness Sm</b> 12.5" - 18.5"	\$400.00	
_____ GRI950-3/4	<b>Ergonomic Harness Md</b> 14.5" - 20.5"	\$400.00	
_____ GRI950-5	<b>Ergonomic Harness Lg</b> 18.5" - 26.5"	\$400.00	
_____ GR825	<b>Chest Support Mn</b> each support is 11.5" long	\$400.00	
_____ GRI9511	<b>Chest Support Sm</b> each support is 13" long	\$400.00	
_____ GRI9512	<b>Chest Support Md</b> each support is 15" long	\$400.00	
_____ GRI9513	<b>Chest Support Lg</b> each support is 18" long	\$400.00	

**Bars to attach HandleOptions Required**

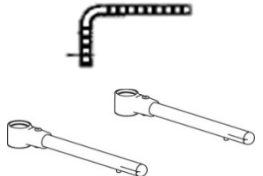
Part Number	Description	Price	
_____ GR835	<b>Horizontal Bars Mn</b> 6.5" long	\$145.00	
_____ GRI835-1	<b>Horizontal Bars Sm</b> 8.5" long	\$150.00	
_____ GRI835-3	<b>Horizontal Bars Md, Lg</b> 10.5" long	\$165.00	

**Handle Options**

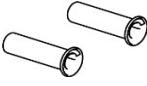
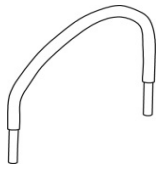
Part Number	Description	Price	
_____ GR927	<b>Posterior Hand Grips Mn</b> requires GR835	\$50.00	
_____ GR927-1/2	<b>Posterior Hand Grips Sm, Md, Lg</b> requires GR835-1, GR835-3	\$50.00	
_____ GR926	<b>Anterior Handle Bar Mn</b> requires GRI-HW, GR835	\$100.00	
_____ GRI845-1	<b>Anterior Handle Bar Sm</b> requires GRI-HW-1, GR835-1	\$100.00	
_____ GRI845-3	<b>Anterior Handle Bar Md</b> requires GRI-HW-1, GR835-3	\$125.00	
_____ GRI845-5	<b>Anterior Handle Bar Lg</b> requires GRI-HW-1, GR835-3	\$150.00	
_____ GRI939	<b>Ergonomic Handles Mn, Sm, Md, Lg</b> requires GRI-HW, GR835	\$125.00	
_____ GRI-HW	<b>Multi Axis Hardware Mn</b>	\$75.00	
_____ GRI-HW-1	<b>Multi Axis Hardware Sm, Md, Lg</b>	\$75.00	

**Arm Support Options**

Part Number	Description	Price
GR809	<b>Arm Supports Mn</b> 7" long 4" wide requires GRI-HW, GR835	\$550.00
GRI809-1	<b>Arm Supports Sm</b> 6" long 4" wide requires GRI-HW-1, GR835-1	\$600.00
GRI809-3	<b>Arm Supports Md</b> 7.5" long 4.5" wide requires GRI-HW-1, GR835-3	\$650.00
GRI809-5	<b>Arm Supports Lg</b> 8" long 5" wide requires GRI-HW-1, GR835-5	\$650.00
<u>Description:</u> Works with Anterior and Posterior. Adjustable in height, direction, depth, tilt, and inclination.		
943	<b>Arm Straps Mn, Sm (pair)</b>	\$40.00
943-3	<b>Arm Straps Md, Lg (pair)</b>	\$40.00
32707	<b>Elbow Stop Sm, Md, Lg</b> 4"x3" padded elbow stop (pair)	\$385.00
50048	<b>Elbow Stop Cover with Gel Insert (pair)</b> requires 32707	\$250.00

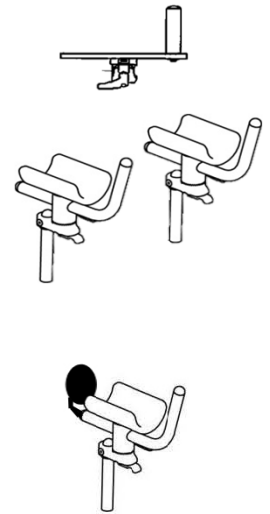

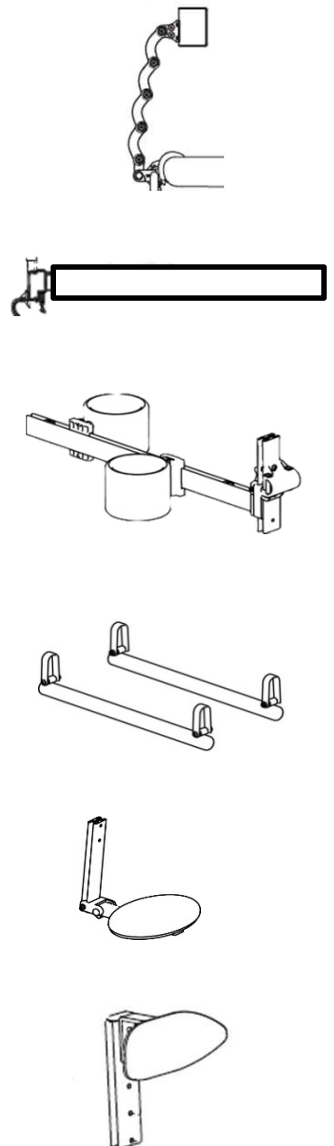

**Accessories**

Part Number	Description	Price
GRI865	<b>Headrest Sm, Md, Lg</b> POSTERIOR ONLY 10" height adjustment Requires Chest Support	\$550.00
GR890-0	<b>Padded Leg Divider Mn</b> 22" long	\$350.00
GRI890-1	<b>Leg Divider Sm</b> 21" long, cuff size 10" - 16"	\$650.00
GRI890-3	<b>Leg Divider Md</b> 23" long, cuff size 14" - 20"	\$700.00
GRI890-5	<b>Leg Divider Lg</b> 28" long, cuff size 18" - 26" <u>Description:</u> Adjustable in height and stride length.	\$750.00
GRI810-1	<b>Weight Bars Sm</b> 11.5 lbs. total	\$275.00
GRI810-3	<b>Weight Bars Md, Lg</b> 15 lbs. total	\$295.00
GRI918-1	<b>Folding Seat Sm</b> POSTERIOR ONLY 10" deep, 6" wide	\$335.00
GRI918-3	<b>Folding Seat Md</b> POSTERIOR ONLY 11" deep, 7" wide	\$365.00
GRI919-1	<b>Lumbar Support Sm</b> POSTERIOR ONLY 3" tall, 8" wide	\$280.00
GRI919-3	<b>Lumbar Support Md</b> POSTERIOR ONLY 4" tall, 9.5" wide	\$280.00

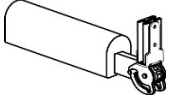
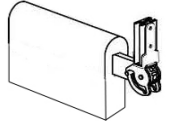

## Accessories

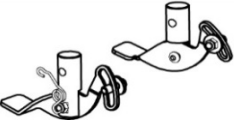
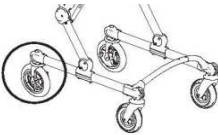
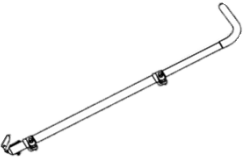
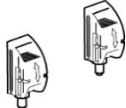
Part Number	Description	Price	
_____ GR815-1	<b>Abduction Saddle Sm</b> pad W: 2.5" H: 3.5" L: 10" Overall L: 14"	\$345.00	
_____ GR815-3	<b>Abduction Saddle Md</b> pad W: 3" H: 3.5" L: 12" Overall L: 16"	\$365.00	
_____ GR815-5	<b>Abduction Saddle Lg</b> pad W: 3" H: 4" L: 14" Overall L: 19" distance between pelvic harness and saddle top hole 4.5" bottom hole 6"	\$445.00	
_____ 34429	<b>Saddle Extension Sm</b> 6" of extended abduction requires GR815-1	\$175.00	
_____ 34430	<b>Saddle Extension Md</b> 6" of extended abduction requires GR815-3	\$185.00	
_____ 34431	<b>Saddle Extension Lg</b> 6" of extended abduction requires GR815-5	\$195.00	
_____ GR929-0	<b>Pedal Parking Brakes Mn</b> Comes attached to wheel	\$275.00	
_____ GR929	<b>Pedal Parking Brakes Sm, Md, Lg</b>	\$275.00	
_____ GR928-3/4	<b>Narrow Rear Wheels Md</b> with pedal brakes In-line wheel makes the over all width 27" instead of 30"	\$675.00	
_____ GR928-5	<b>Narrow Rear Wheels Lg</b> with pedal brakes In-line wheel makes the over all width 28.5" instead of 31.5" for Lg	\$675.00	
_____ GR923	<b>Assistant Push Handle Mn, Sm, Md, Lg</b>	\$290.00	
_____ GR-DL	<b>Directional Locks Mn, Sm, Md, Lg</b>	N/C	

**Client Measurements**

A Back height: \_\_\_\_\_ F Lower leg length: \_\_\_\_\_  
 B Chest depth: \_\_\_\_\_ G Head height: \_\_\_\_\_  
 C Chest width: \_\_\_\_\_ H Arm height: \_\_\_\_\_  
 D Seat depth: \_\_\_\_\_ Age: \_\_\_\_\_  
 E Seat width: \_\_\_\_\_ Weight: \_\_\_\_\_

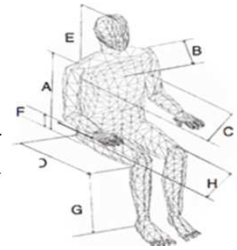

**Dimensions**

Measurements in Inches

Grillo	Mini	Small	Medium	Large
Max Capacity	77 lbs	99 lbs	198 lbs	242 lbs
User Height	29 - 39	35 - 53	43 - 65	59 - 75
Unit Weight	28 lbs	36 lbs	43 lbs	51 lbs
<b>A</b>	21 - 31	23.5 - 34	29 - 47	33 - 55
<b>B</b>	20 - 29.5	27 - 39	30 - 49	32 - 56
<b>C</b>	16.5 - 24	19 - 33	21 - 39	25 - 46
<b>D</b>	29	29.5	36	43.5
<b>E</b>	22.5	25.5	30	31.5

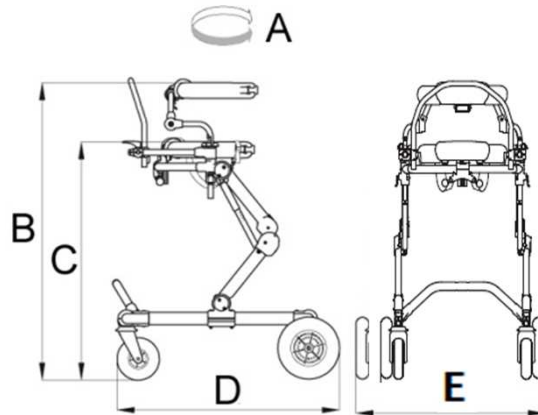

**One Frame → 7 Configurations**

Note: All specification and prices are subject to change without notice. Prices listed are only valid if ordering with a gait trainer. The HCPCS codes provided are not intended to be billing or legal advice, rather Innovation In Motion's interpretation of the code definitions. Use of the codes provided does not ensure coverage or payment for the item. For coverage information, verify the policy of the appropriate payer. It is recommended to contact Innovation In Motion with any questions regarding proper ordering of the chair at 1-260-665-2769.