

Medium Steam T-G Application/Features

Features

- Robust, Fast and Flexible Control System designed for the Complex Controls and Protection of today's Steam Turbine Applications.
- Easily Expandable to meet Customer I/O Requirements for Steam Turbine Generator and Balance Of Plant Controls.
- Greater than 80% of Parts used are Commercial Off The Shelf (COTS). All Parts are Available from Turbine Diagnostic Services or the Manufacturer.
- Open Control System with Complete Customer Access to Programming and Graphics for Troubleshooting or Modification.
- Integrated Digital Control System Architecture that is Expandable.
- Self-Documenting Software for Processor Sequencing and Graphics Design.
- Integrated Triple Redundant Speed Input/Back Up Over-Speed Protection.
- Online Over-Speed Trip Testing.
- Integrated Hydraulic Valve Position Servo Loop Control designed with Redundancy in mind.
- Low Density Input Termination Boards Specific to Each Type of Standard & Custom I/O.
- Primary and Secondary Control Processors with automatic Swap on Failure in Either Direction.
- 20 ms (50Hz) Processor Scan Rate.
- >200 Hz Servo Loop Processing.
- 900 Hz Speed Sensor Processing.
- Optional Integral Data Storage Historian.
- Optional Sequence of Events 1ms Time Stamping and GPS Time Sync.
- Integrated Vibration Monitoring, Filtering, Diagnostic Analysis and Plotting Capability and Long-Term Storage and Analysis Review Capability with TurboNet Historian.
- Linux based Operating System for HMI, EWS, and Historian Processors.
- LYNX OS based Hard Real Time Operating System on Single Board Computer Control Processors.

General Applications

The **TurboNet DASH 1®** is a robust, low-cost Digital Control System (DCS) that has been designed by Turbine Diagnostic Services, Inc. (TDS) specifically to control gas and steam turbine generators of all sizes and configurations. TurboNet is expandable to control and monitor all turbine generator functions, and if desired, the Balance of Plant (BOP) controls, as well. While the basic TurboNet System will control the turbine generator and associated subsystems for status monitoring and alarm functions, the system is expandable with options such as: a sequence of events recorder, a historian, vibration monitoring, and generator auto-sync. To meet the Customer's needs, these options can be installed initially or, added at a later time. The TurboNet System for Medium Steam Turbine Generators (MSTG) is truly a custom configurable DCS that can be customized to provide any range of options and desired I/O complexity required by the Customer.

TurboNet DASH 1® has been applied to control turbines supplied from many Original Equipment Manufacturers. Designed to accommodate all types of applications including, but not limited to: two and three shaft machines, simple and combined cycle machines, black start machines and turbines with gas or liquid fuel combustion (with or without water or steam injection, for NOx control). Please contact Turbine Diagnostic Services, Inc. for our Installation Experience listing.

General Description

The **TurboNet DASH 1®** is a DCS structured control system. Its design and evolution was influenced by start-up field engineers that understand and have installed different control systems. With face-to-face customer interaction, these seasoned engineers have an understanding of the design features required for turbine generator control and have an appreciation for the requirement for user friendly features that customers insist on. The many features incorporated in the **TurboNet DASH 1®** are in demand and desired by operators, technicians, and engineers alike. These features enable users to effectively operate, troubleshoot, and program their control system needs for today's efficient, reliable facilities.

The **TurboNet DASH 1®** integrated DCS system provides: standard I/O as well as specialized I/O for servo loop control, speed input, over-speed protection, vibration monitoring and analysis capability for proximity and velocity coil inputs, and sequence of event recording with 1ms time stamping. TurboNet can support any level of I/O redundancy desired by the customer, including EHC closed loop valve position control for single and triple-redundant servo coils and single, double, or triple LVDT feedback. TurboNet can be applied to open loop controlling valve arrangements or offers optional upgrade options to closed loop control.

Contact Turbine Diagnostic Services, Inc. for a demo of our **TurboNet DASH 1®** system. Our headquarters are located in Odessa, Florida. We invite you to schedule a visit, review available installation options or to discuss design features in detail with us. To do any of these or to request a **TurboNet DASH 1®** Product Specification you may contact us at: (727) 375-8700, extension 1228 or sales@turbinedoctor.com

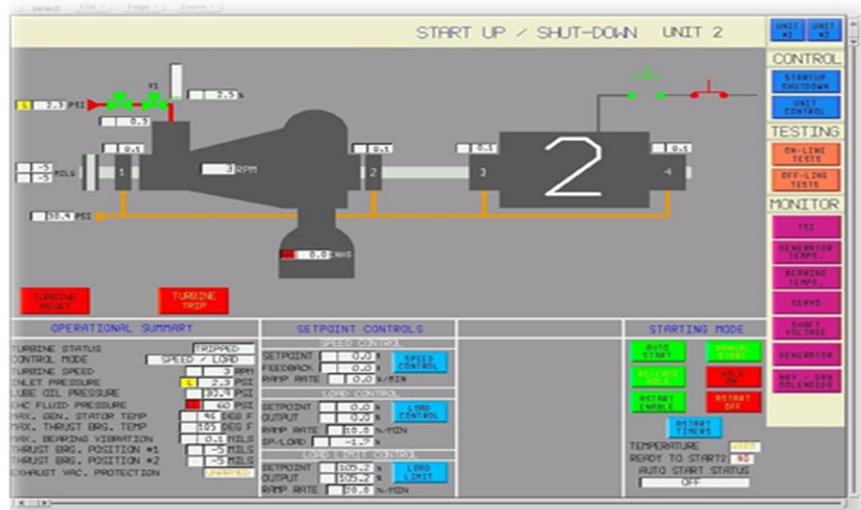

TurboNet DASH 1® Startup/Shutdown Graphics installed for MSTG Unit

TurboNet DASH 1® Hardware Features

New HMI/EWS Chassis / Historian Processor

- Core i3-2100, Series 3.1 GHz, Industrial Chassis Computer
- Linux based Operating System

Redundant Lambda 24vdc, 300W, 40A Power Supplies

- Diagnostic LED's and Alarms
- Gated Power Supplies can be Replaced Online



Redundant Control Processors

- Pinnacle Data Systems, Avnet Single Board Computer
- LYNX OS - Hard Real Time Operating System by Linuxworks Inc.
- 20ms I/O Scan Rates & Sequence Processing Time,
- Flash Card Memory Eliminates Hard Drive Failures
- 50ms Swap Time on Failure of Controlling Processor

Standard I/O Modules

Automation Direct Manufactured Terminator I/O Series Modules

- Hot Pluggable Modules Mounted In Standard Bases
- Individual I/O String Power Supplies
- Communication by Ethernet Controller on Internal EIO Data Highway to Control Processors

Custom TDS Termination Boards

- Custom TDS Low Density Terminal Strips with I/O Protection, Fusing and Additional Options are available



**Steam Turbine Generator Cabinet with Auto Sync
(Bay Doors Open)**

Specialty Modules

- Supplied by Host Automation Products - Designed To TDS Specifications
- Hot Pluggable Modules Mounted In Standard Terminator I/O Bases
- Seamless Interface to Terminator I/O Standard Hardware and Ethernet Based Controller EIO Data Highway

Over-speed/Speed Module with High Speed Processor Module

- Triple Redundant Passive Speed Probe Inputs (2 shaft capability)
- Integrated 2 out of 3 Hardwired Backup Over-speed Protection
- Pulse Width Measurement Down To 15mv
- Speed Resolution <1Hz @3600Hz
- Processes Speed Feedback at a Scan Rate Equivalent to 900Hz at a Rated Speed of 3600rpm with 60 Tooth Wheel
- Zero Speed Detection & Turning Gear Speed Monitoring above 2Hz
- On Line ETR Trip Testing With ETR Feedback for Trip and Reset Conditions for All 3 Channels
- Provisions for External Hard Wired Trips



CHANNEL	PROXIMETER MONITOR						
	DIRECT	GAP VOLTAGE	1X	ANGLE	2X	ANGLE	ROTOR POSITION
BB 1X	0.05 MILS	-8.67 VDC	0.00 MILS	0 DEGS	0.00 MILS	0 DEGS	-1.5 MILS
BB 2X	0.05 MILS	-9.16 VDC	0.00 MILS	0 DEGS	0.00 MILS	0 DEGS	-0.5 MILS
BB 3X	0.05 MILS	-8.96 VDC	0.00 MILS	0 DEGS	0.00 MILS	0 DEGS	0.7 MILS
BB 4X	0.09 MILS	-8.40 VDC	0.00 MILS	0 DEGS	0.00 MILS	0 DEGS	-0.4 MILS
AXIAL #1		-7.29 VDC					
AXIAL #2		-6.84 VDC					

Vibration - Proximity & Velocity Coil - Axial Position / ECC / DXD / RXD / Ref Probe / Seismic

- Graphical Data Display
- Diagnostic Analysis as Shown Above (unfiltered, 1X Vector, 2X Vector, Gap Voltage/Shaft Position)
- FFT Analysis to 128 Hz with Update @ 2Hz for 1x & 2x Running Speed & Unfiltered Signal Update @ 10Hz
- HMI Plotting (Trend, 1X Polar, 2X Polar, X-Y Shaft Centerline)
- Historian Adds Long Term Data Collection and Post Event Diagnostics – Like Having and Analyzer On Board
- Buffered Outputs for external Diagnostic Analyzer Connection

Servo Loop Control Module

- Module Processor Scan Rate > 200 Hz
- Single, Double, & Triple Redundant LVDT & Servo Coil Configurations for MSTG Control Philosophies
- All TG OEM Steam Turbine Closed Loop Valve Position Control Schemes Supported
- Open Loop or Closed Loop Control Options
- Up to 200mA Output Total for Both Channels

Integrated Generator Control, Sync, and Protection

- Interconnection Terminal Boards & Shorting Strips
- Optional Custom Configurations

- GE Multilin or SEL Generator Protection Relay
- PT Disconnect Switches
- CT Shorting Switches
- Lockout Relay & Indicating Light
- Custom Made Manual Sync Panel
- Auto Sync - Basler BE1-25A
- Sync Check Relay - Basler BE1-25
- Basler DECS-200 or DECS-400 Series Voltage Regulator



TurboNet DASH 1® System Specifications:

TDS Standard I/O Modules:

- Available from TDS or Automation Direct
- Hot Pluggable
- No Calibration Required

Digital/Contact Input Module (T1K-16ND3)

- 16 Inputs per Module
- 10.8-26.4 VDC Input Voltage Range
- 30 VDC Peak Range
- 8.5 mA @ 24 VDC Input Current
- 2.8 KΩ Input Impedance
- >10 VDC ON, <2VDC OFF Voltage Level
- 4mA Min ON, 0.5mA Max OFF Current
- 2-8ms, Typical 4ms OFF to ON Response
- 2-8ms, Typical 4ms ON to OFF Response
- Logic Side Status Indicators

Analog Current Input Module (T1F-08AD-1)

- 8 Single-Ended Channels per Module
- 0-20mA Range
- 14 bit Resolution
- -3db @ 500 Hz, -20db/decade Frequency Response
- 250Ω Input Resistance
- 8V Absolute Max Rated Input
- 5 ms/channel Normal Mode Conversion Time
- 0.5 ms/channel Fast Mode Conversion Time
- +/-2 counts Max Linearity Error
- +/-1 count Normal Mode Input Stability
- +/-5 count Fast Mode Input Stability
- 16 counts Max Full Scale Error
- 2 counts Max Offset Error
- 0.18% @ 25°C, 0.36% @ 60°C Max Full Scale Inaccuracy
- 8 channels per Scan Max Master Update Rate

Thermocouple Input Module (T1F-14THM)

- 14 Differential Inputs per Module
- +/- 5VDC Common Mode Range
- 90db min, @ DC, 150db min, @ 50/60 Hz. Common Mode Rejection
- 1 MΩ Input Impedance
- Fault-Protected Inputs to +/- 50VDC Absolute Maximum Rating
- +/- 5ppm/°C Maximum Full Scale Calibration Accuracy
- 14 Channels per Scan Max Master Update Rate
- 32° to 140°F Operating Temperature
- -4° to 158°F Storage Temperature
- 5 to 95% (Non-Condensing) Relative Humidity
- NEMA ICS3-304 Noise Immunity

RTD Input Module (T1F-16RTD)

- 16 Channels per Module
- 0-5VDC Common Mode Range
- +/- 0.1°C Resolution
- >50db Notches @ 50/60 Hz, f-3db=13.1 Hz Notch Filter
- +/- 50VDC Absolute Maximum Rating
- Charge Balancing, 24 bit Converter
- 16 Channels per Scan Max Master Update Rate
- 140ms/channel Sampling Rate
- 25ppm/°C Temperature Drift
- +/-1°C Maximum Inaccuracy
- 200µA RTD Excitation Current
- 32° to 140°F Operating Temperature
- -4° to 158°F Storage Temperature
- 5 to 95% (Non-Condensing) Relative Humidity
- NEMA ICS3-304 Noise Immunity



Factory Wiring



Typical Module

TDS Standard I/O Modules cont. :

Analog Current Output Module (T1F-08DA-1)

- 8 Channels per Module
- 0-20mA, 4-20mA Output Range
- Single Ended Output
- 12 bit Resolution
- 30VDC Max Loop Supply
- 30VDC Peak Output Voltage
- 0Ω Min Load Impedance
- +/-2 counts, +/-0.05% of Full Scale Max Linearity Error
- 400µs Max Full Scale Change Conversion Settling Time
- +/- 12 Counts Max Full Scale Calibration Error
- +/-6 counts Max @ 0-20mA or 4-20mA Offset Calibration Error
- +/-50ppm/°C Full Scale Calibration Change Accuracy
- 0.2% @ 25°C, 0.4% @ 60°C Max Full Scale Inaccuracy
- 8 Channels per Scan Max Master Update Rate

Analog Voltage Output Module (T1F-08DA-2)

- 8 Single-Ended Channels per Module
- +/-10V Output Range
- 12 bit Resolution
- 15VDC Peak Output Voltage
- 4kΩ Min Load Impedance
- 0.01µF Max Load Capacitance
- +/-2 Counts Max +/-0.05% of Full Scale Linearity Error
- 100µs Max Full Scale Change Conversion Settling Time
- +/-6 counts Max @ 10V, +/-11 counts Max @ 5 V Offset Calibration Error
- +/- 50ppm/°C Full Scale Calibration Change Accuracy vs. Temperature
- 10V: 0.02% @ 25°C, 0.4% @ 60°C Max Full Scale Inaccuracy (% of Full Scale)
- 8 Channels per Scan Max Master Update Rate

Analog Voltage Input Module (T1F-08AD-2)

- 8 Single-Ended Channels per Module
- 0-5V, 0-10V, +/-5V, +/-10V Input Ranges
- 14 bit Resolution
- -3db@500hz, -20db/decade Frequency Response
- 200kΩ Min Input Resistance
- Fault Protected Input 130Vrms or 100 VDC Absolute Max Rating
- 5ms per Channel Normal Mode Conversion Time
- 0.5ms per Channel Fast Mode Conversion Time
- +/-2 counts Max Linearity Error
- +/-1 count Normal Mode Input Stability
- +/-5 count Fast Mode Input Stability
- 8 counts Max Calibration Full Scale Error
- 2 counts Max Calibration Offset Error
- 0.08% @ 25°C, 0.26% @ 60°C Max Full Scale Inaccuracy (% of Full Scale)
- 8 Channels per Scan Master Update Rate

Power Supply Module (T1K-01DC)

- 12/24 VDC Input Range
- 30W Maximum Power
- 10A Maximum Inrush Current
- >10MΩ @ 500VDC Insulation Resistance
- 2000mA Max at 5.25 VDC with 5% Max Ripple

Digital Output Module (T1K-08TD1)

- 5-27 VDC Input Range
- 5-30 VDC Output Range
- Peak Voltage 50 VDC
- Off to On Response < 10us
- On to Off Response < 60us

EIO Ethernet Based Controller for I/O Modules (T1H-EBC)

- 10BaseT Ethernet
- 10Mbps Transfer Rate
- 100m Link Distance
- 350mA Power Consumption

TurboNet DASH 1® Environmental Specifications

Operating Temperature: 0-40°C
Storage Temperature: 0-60°C
Power Input Range (Volts): 85 – 265 VAC (47-63Hz) or 120 – 330 VDC
(Amps): Varies Based on Application

TurboNet DASH 1® System Specifications:

TDS Custom I/O Modules and Boards:

Made by Host Engineering (Automation Direct) for TDS
Seamless Integration with Terminator I/O line of Standard Modules
Hot Pluggable
No Module Calibration Required Except Servo Loop LVDT Module

- **Speed / Over-speed Module (CTRIO-M)**
 - 2 Inputs per Module
 - Uses Passive Speed Probes
 - 2Hz Minimum Frequency
 - 15mV Min Signal Amplitude Detected
 - Zero Speed Detection
 - Backup Over-speed Protection
- **Loop Control Input Module (LC2)**
 - 2 LVDT Inputs per Module
 - 4 Analog Inputs for Demodulated Outputs
 - 2 Servo Outputs per Module
 - 2 Magnetic Speed Probe inputs
 - 200Hz Min Scan Rate
 - Selectable Range for Servo Outputs, +/-10, 20, 40, or 100
 - ~3V AC @ 3200Hz LVDT Excitation Signal
 - Monitor Valve Position or Case Expansion Using LVDTs
- **Sequence of Events (SOE)**
 - 16 Channels and Sensing Power Detection
 - 250V Max Sensing Voltage
 - Programmable Voltage Threshold
 - Self-Tests Hardware Once per Second
 - 1ms Time Stamping
 - Serial Input & Output for Cascaded Time Sync
 - Synched to GPS Time w/ Optional GPS Clock
- **Vibration Input Module (VIB)**
 - 2 Proximeter Channels or 2 Velocity Coil Inputs & Reference Probe per Module
 - Open Circuit and Shorted Coil Detection for Velocity Coils
 - 128Hz Max. FFT
 - Buffered Outputs for All Signals
 - Analyzes Vibration, Axial Position, Eccentricity, and Differential Expansion



Left Hand Bay Access Door Open.
Showing From Panel Top and Down :

- Dual Cooling Fans
- 24 vdc Power Supply
- Redundant Control Processors
- Ethernet Switch
- I/O Modules



Factory Assembled Module Strings Located In Right Hand Bay Module Door

I/O Modules
Specialized Input / Output Modules Interface with the processors through the Ethernet Input/ Output Highway

Termination Boards

- All Termination Boards are 2-Layer Through-Hole Construction and are Easy to Repair
- All Boards Have Low-Density Terminal Strips except the Thermocouple & RTD Boards

Termination Boards

Termination Board	Overall Fuse	Individual Shield Screws	Individual Fuse Protection	Transient Voltage Protection	Additional Features (See Listing Below)
Digital Input	X			X	2,3
Relay Output	X		X		1,5,8,14
Voltage Input & Output	X	X	X	X	1,13
Milliamp Input	X	X	X	X	1,13
Milliamp Output	X	X	X	X	1,13
Thermocouple Input	X	X	X	X	6,7,13
RTD		X			13
Speed/Over Speed	X	X	X		1,5,8,9,10,11,13,14
LVDT/Servo	X	X		X	6,12,13
Vibration	X	X		X	4,6,13
Sequence of Events	X			X	14
DCT/Servo	X	X		X	6,12,13

1. Can Power Devices off Internal 24/125VDC or External Power
2. Can Support 3 Modules for Triple Redundancy
3. 1 Channel Dedicated to Sensing Power Monitoring
4. BNC Connectors for Buffered Outputs for Each Channel
5. Relays are Socketed
6. Isolated & Grounded Power Supply
7. CJC at Termination Board
8. Form C Contacts
9. Triple-Redundant ETR's
10. 2 Channel Trip Relays – Fused
11. 3 External Hard-Wired Trips
12. Contains Excitation Amplifier
13. Individual Shield Connections
14. Plugs for External Power



Left Hand Bay Termination Boards

TurboNet DASH 1® System Specifications:

Standard Cabinets and Bays

Front Cabinet Panel Bay Views



Standard Single Sided Three Bay
22.5" Deep x 81.25" Wide x 85.25" Tall cabinet
TURBINE GENERATOR APPLICATION
Typical* STG I/O Count

DESCRIPTION	TOTAL CHANNELS
CONTACT INPUT	32
CONTACT OUTPUT	16
MILLIAMP INPUT	08
VOLTAGE INPUT	08
MILLIAMP OUTPUT	08
RTD INPUT	16
SPEED / OVERSPEED	03
SERVO / LVDT LOOP CONTROL	04
VIBRATION / KP	10
MODBUS (Master) RTU RS485	02

*TDS specifically designs cabinets for all levels of I/O requirements. Based on the customer's requirements, multiple cabinets may be used to perform a control system installation. I/O channels shown are only typical.

Internal Cabinet Panel Bay Views

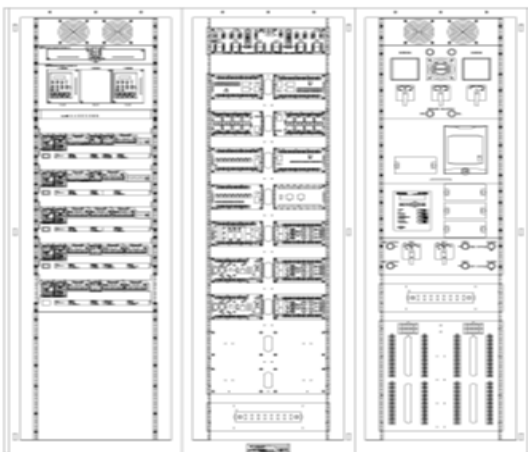

The Basic Architecture of TurboNet DASH 1®

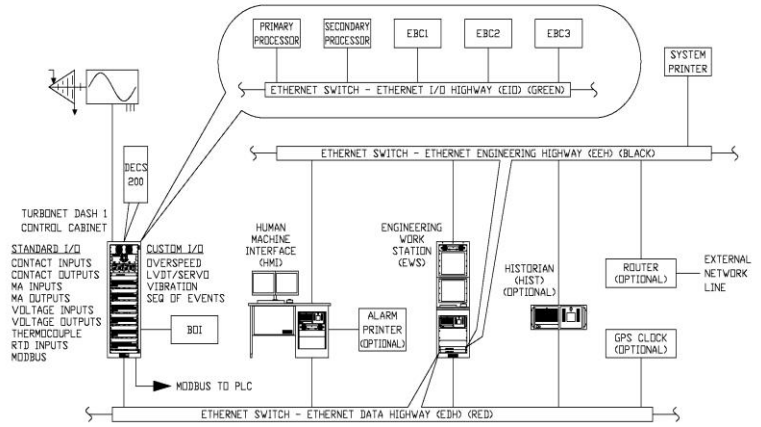

Signals from the field are collected at the termination boards and sent to the modules for processing. The modules send data to the processors for further analysis. The processor sends the data over the Ethernet Data Highway to the HMI, EWS, and Historian, and through the Modbus to the plant's DCS. The data passes through these components to the Ethernet Engineering Highway where a router can allow for external access, allowing long-distance troubleshooting.

Programming Software Display Capability

TURBONET SOFTWARE FEATURES

- LINUX Operating System with Remote Access, Troubleshooting, and Reprogramming Capability

TURBONET ARCHITECTURE

- Integrated DCS Structure Using Ethernet Data Highways
- Allows On Line Component Replacement
- Scalable to Need

TURBONET PROTOCOL

- Integrated System Code Developed By TDS
- Uses Reliable Lynx OS Operating System
- 50 Hz Scan Rate

GRAPHCAD

- Graphical HMI Graphics Generator
- Loop & Graphics Self Documenting
- Allows Drag & Drop On-Line Changes

LOOPCAD

- CAD Graphical Loop Sequence Generator
- Similar to SAMA
- Uses Custom Blocks
- Allows On Line Diagnostics & Reprogramming

GRAPHICAL DISPLAY

- 1 or 2 Monitors Per HMI Computer
- Up to 4 Graphical Displays Per HMI
- Displays Alarms, On Line Changes, Pop Up Screens

HMI & EWS

- User Friendly
- Crash Free Operation
- Mouse Driven, Uses Virtual Keyboard
- Allows Trends & Plotting off of graphics

HISTORIAN

- Seamless Interface to HMI
- Offers Long Term Data Storage & Retrieval
- Commercially Available Hardware & Memory

TurboNet DASH 1® System Specifications:

Programming Software Display Capability

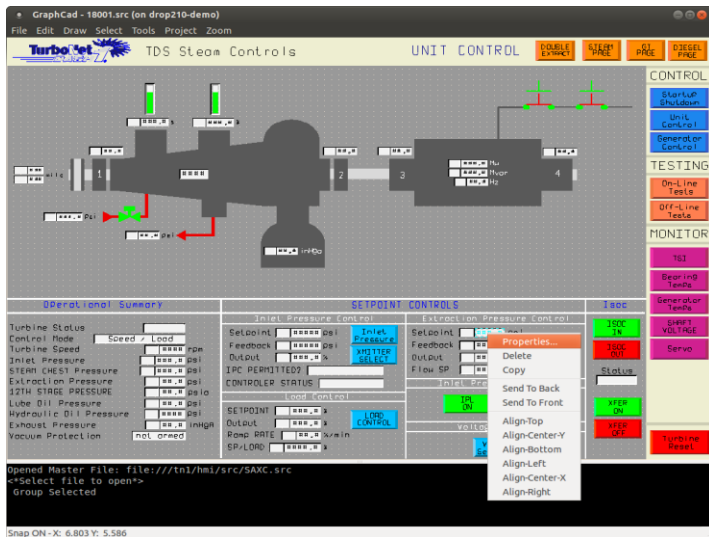

Using GraphCAD to Change the Set-point Control Screen for a Single Auto Extraction Turbine Generator

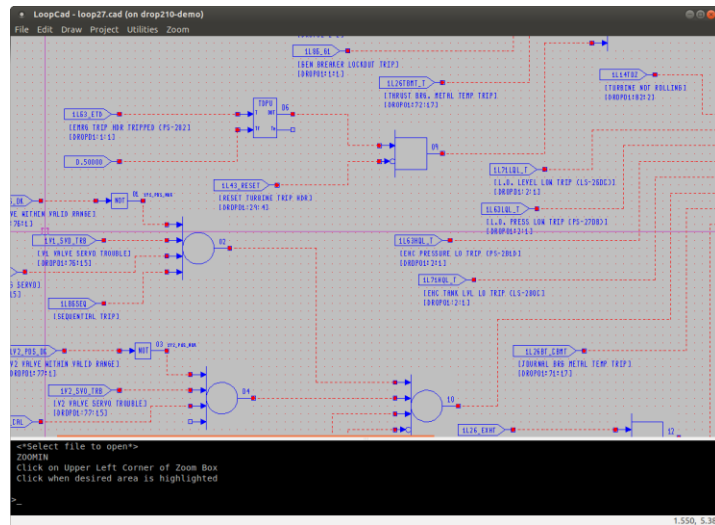

Using LOOPCAD to Program Unit Logic

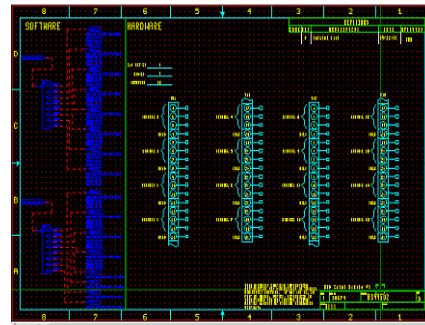

Using LOOPCAD to Connect Software Logic and Hardware Devices

Color Palette

The Color Palette for GRAPHCAD is made up of 256 distinct, fixed and defined colors from the RGB spectrum. Selection of colors is offered in a "drop down" listing which provides an example of the specific color and identifies its specific name. This type of palette quantization is preferred by Operators so that display selection colors are consistent and can be emulated across various terminal screens without variation. Those systems which require Operators to make a color selection from a "homogeneous RGB color cube or wheel screen" lead to inconvenient terminal image system management that has the potential for error and inconsistency for arbitrary colors previously selected and used.

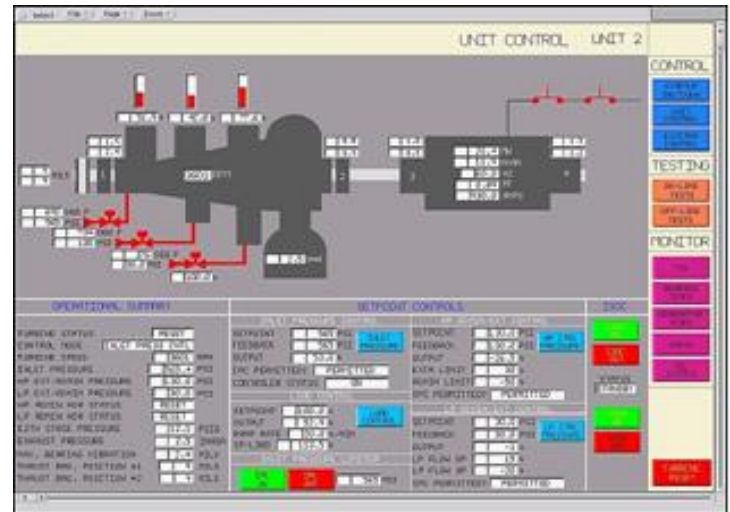

Finished Set-point Control Screen for a Double Auto Extraction Turbine Generator

Turbine Diagnostic Services, Inc. (TDS) is a full service turbine generator field service organization based in Odessa, Florida. **TDS** specializes in conducting steam & gas turbine generator planned & emergency maintenance controls troubleshooting, and vibration analysis & balancing services.

TDS has developed the **TurboNet DASH 1®** Control System from the ground up and each unit is custom configured to meet your specific needs. Contact Turbine Diagnostic Services, Inc. for a demo of our **TurboNet DASH 1®** system at our headquarters in Odessa, Florida. Contact us at: (727) 375-8700, extension 1228 or sales@turbinedoctor.com to Schedule a Visit, Review Installation Options, Discuss Design Features in Detail or to Request a **TurboNet DASH 1®** Product Specification.



For Info: (727) 375 - 8700
National 24 Hr. Emergency Service
Toll Free (877) 969 - 0972
www.turbinedoctor.com