



**TALC**  
**Home Inspe**

## **Inspection Report**

**Mrs. Gail Schneider**

**Property Address:**  
780 Nutfield Way  
Richmond KY 40475



**Talon Home Inspections, LLC**

**Giancarlo Barone HI-103 758  
4101 Tates Creek Centre Drive  
Suite 150 - PMB 312  
Lexington, KY, 40517  
(859) 447 0050**

L Name



## Table of Contents

<a href="#">Cover Page</a> .....	1
<a href="#">Table of Contents</a> .....	4
<a href="#">Intro Page</a> .....	5
<a href="#">1 Structural Components</a> .....	7
<a href="#">2 Roofing / Chimneys / Roof Structure and Attic</a> .....	10
<a href="#">3 Exterior</a> .....	25
<a href="#">4 Garage/Carport</a> .....	41
<a href="#">5(A) Kitchen / Components and Appliances Main Kitchen</a> .....	47
<a href="#">5(B) Kitchen / Components and Appliances Basement Kitchen</a> .....	52
<a href="#">6 Rooms</a> .....	61
<a href="#">7 Bathroom and Components</a> .....	71
<a href="#">8 Plumbing System</a> .....	78
<a href="#">9 Electrical System</a> .....	89
<a href="#">10(A) Heating / Central Air Conditioning Unit 1 Lower Level</a> .....	98
<a href="#">10(B) Heating / Central Air Conditioning Unit 2 Upper Level</a> .....	107
<a href="#">Repair/ Replace General Summary</a> .....	113
<a href="#">Conditional General Summary</a> .....	152
<a href="#">Invoice</a> .....	166
<a href="#">Back Page</a> .....	167



<b>Date:</b> 7/15/2018	<b>Time:</b> 09:00 AM till 03:00 PM	<b>Report ID:</b> 180715BETHAM
<b>Property:</b> 780 Nutfield Way Richmond KY 40475	<b>Customer:</b> Mrs. Gail Schneider	<b>Real Estate Professional:</b>

## **Congratulations and Thank you for choosing Talon Home Inspections.**

In order for you to receive the full value of this inspection please read all of the information in your Inspection Report. Should you have further questions, please contact our office during regular business hours 7 days a week and we will be happy to assist you.

### **Photo/Video Documentation.**

Your report includes many photographs. Most of the pictures are a general view, to help you understand where the inspector has been, what is looked at, and the condition of the item or area at the time of the inspection. Most of the pictures will be of problem areas, the pictures are to help you better understand what is documented in the report and to help you see areas or items that you normally would not see. Not all problem areas and conditions will be supported with pictures, that will be up to the discretion of the inspector.

### **Comment Key or Definitions**

The following definitions of comment descriptions represent this inspection report. All comments by the inspector should be considered before purchasing this home. Any recommendations by the inspector to repair or replace suggests a repair, second opinion or further inspection by a qualified contractor. All costs associated with further inspection fees and repair or replacement of an item, component or unit should be strongly considered before you purchase the property.

**Inspected (IN)** = I visually observed the item, component or unit and if no other comments were made then it appeared to be functioning as intended allowing for normal wear and tear.

**Not Inspected (NI)**= I did not inspect this item, component or unit and made no representations of whether or not it was functioning as intended and will state a reason for not inspecting.

**Not Present (NP)** = This item, component or unit is not in this home or building.

**Conditional (C)** = I visually observed the item, component or unit and it appeared to be functioning as intended, but is in need of a minor repair and/or correction. This will ensure the item, component or unit is performing or functioning as intended.

**Repair or Replace (RR)** = The item, component or unit is not functioning as intended, or is defective, is unsafe or hazardous, or needs further inspection/evaluation by a qualified contractor. All comments made that are marked as Repair or Replace in this report and/or in the summary should be dealt with before you purchase the property.

**Note:** Any Items, components or units mentioned in the report that can be repaired to satisfactory condition may not need replacement.

### **THIS REPORT IS NOT A WARRANTY.**

**Our report is not a guarantee or warranty on the condition of the property or its contents. This inspection service only warrants that its inspection service and report will be performed in accordance with scope and standards of practice of the American Society of Home Inspectors (ASHI).**

## Definition of A Home Inspection

By definition, a home inspection is a visual analysis performed for compensation for the purpose of providing a professional opinion and home inspection report by a licensed home inspector, regarding the condition of a residential dwelling and the dwelling's attached garages and carports, any reasonable accessible installed components, and the operation of the dwelling's systems, including any controls normally operated by the owner of the dwelling, for systems and components in the standards of practice established by the Kentucky Board of Home Inspectors. Home inspection does not include a code compliance inspection. The obligations of a home inspector to a client do not extend to third parties who did not hire the home inspector or rely on the inspector's opinions.

**Standards of Practice:**

American Society of Home Inspectors

**In Attendance:**

Seller

**Type of building:**

Single Family (1.5 story)

**House Built In:**

1985

**Home Faces:**

South

**Utilities Status:**

All utilities On

**Temperature:**

80-90

**Weather:**

Overcast, Hot and Humid, Light Rain

**Ground/Soil surface condition:**

Damp

**Rain in last 3 days:**

No

1. Structural Components



The Home Inspector shall observe structural components including foundations, floors, walls, columns or piers, ceilings and roof. The home inspector shall describe the type of Foundation, floor structure, wall structure, columns or piers, ceiling structure, roof structure. The home inspector shall: Probe structural components where deterioration is suspected; Enter under floor crawl spaces, basements, and attic spaces except when access is obstructed, when entry could damage the property, or when dangerous or adverse situations are suspected; Report the methods used to observe under floor crawl spaces and attics; and Report signs of abnormal or harmful water penetration into the building or signs of abnormal or harmful condensation on building components. The home inspector is not required to: Enter any area or perform any procedure that may damage the property or its components or be dangerous to or adversely effect the health of the home inspector or other persons.

Styles & Materials

Foundation Type:

Basement

Foundation Wall Structure:

Masonry Block  
Partially visible

Basement Floor Structure/Covering:

Slab  
Partially Visible  
Carpet  
Tile  
Laminated hardwood

Basement Ceiling Structure/Covering:

2 X12  
Wood joists  
Drywall  
Partial visible

Wall Structure:

Masonry  
and  
Wood frame construction

Columns/ Posts or Piers:

Not visible

Floor System Insulation (Type/R value):

Not visible

		IN	NI	NP	C	RR
1.0	Basement Foundation (signs of moisture)	•				
1.1	Basement Walls (Structural)	•				
1.2	Basement Ceilings (Structural)		•			
1.3	Basement Floors (Structural)	•				
1.4	Wall Structure	•				
1.5	Floors (Structural)	•				
1.6	Ceilings (Structural)	•				
1.7	Ventilation of Foundation Area (crawlspce or basement)					•
1.8	General Comments	•				

IN= Inspected, NI= Not Inspected, NP= Not Present, C= Conditional, RR= Repair or Replace

IN NI NP C RR

Comments:

1.1 Due to the finished materials that were used in the basement I am unable to determine the condition of the walls behind these finished materials. At the time of this inspection there were no visual signs that suggest damage to the walls or excessive moisture conditions in the basement. Inspections are limited and destructive inspections are excluded.

1.2 Most of the ceiling structure in the basement are covered and some structural members are not visible. No obvious problems discovered. I could not see behind these coverings.

**1.3** There is no access under the concrete slab. The floors are covered and structural members are not visible. No obvious problems discovered. I could not see behind these coverings.

**1.4** The wall structure is not visible due to exterior and interior walls are covered. There were no obvious signs of any problems.

**1.5** The inspection of the upper floor structure is not visible due to ceiling and floor coverings/was limited because most of the structural members are not visible. There are no obvious problems visible.

**1.6** The ceilings in the home are covered and structural members are not visible due to insulation and ceiling coverings. No obvious problems discovered. I could not see behind these coverings. Was only able to partially examine ceiling structure.

**1.7** The basement window at the rear right side of the home is at or near ground level. This can allow water entry into the basement. Water intrusion in a basement can lead to more costly repairs and cause mildew or mold to form. Recommend a half-round window well be installed where needed. The dirt inside the well should be replaced with approximately four inches of gravel. A couple of inches clearance between the gravel and window opening is recommended. Recommend a general contractor correct as needed.



1.7 Item 1(Picture)

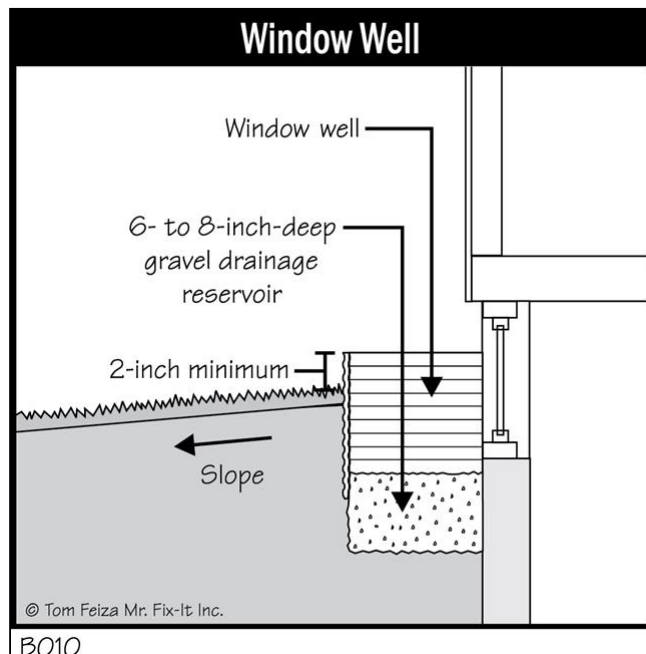

B010  
1.7 Item 2(Picture)



**1.8 (1)** Due to the personal stored items in the basement, we were unable to perform a proper visual examination and assessment of portions of the basement walls and floor at this time. Be sure to review these areas during the final walk through after the stored items have been removed. If you suspect further investigation is needed, recommend either myself or a certified home inspector conduct a more thorough inspection of the basement walls and floor.



1.8 Item 1(Picture) basement kitchen



1.8 Item 2(Picture) basement bonus room

**1.8 (2)** No evidence of moisture penetration was visible in the basement at the time of the inspection. It should be understood that it is impossible to predict whether moisture penetration will pose a problem in the future. The vast majority of basement leakage problems are the result of insufficient control of storm water at the surface. The ground around the house should be sloped to encourage water to flow away from the foundations. Gutters and downspouts should act to collect roof water and drain the water at least five feet from the foundation, or into a functional storm sewer. Downspouts that are clogged or broken below grade level, or discharge too close to the foundation, are the most common source of basement leakage. Please refer to the Roofing and Exterior sections of the report for more information. In the event that basement leakage problems are experienced, lot and roof drainage improvements should be undertaken as a first step.

---

The structure of the home was inspected and reported on with the above information. While the inspector makes every effort to find all areas of concern, some areas can go unnoticed. Please be aware that the inspector has your best interest in mind. Any repair items mentioned in this report should be considered before purchase. It is recommended that qualified contractors be used in your further inspection or repair issues as it relates to the comments in this inspection report.

2. Roofing / Chimneys / Roof Structure and Attic



The home inspector shall observe: Roof covering; Roof drainage systems; Roof ventilation; Roof framing; Flashings; Skylights, Chimneys, and roof penetrations; Attic insulation and thickness; sheathing and decking; and Signs of leaks or abnormal condensation on building components. The home inspector shall describe material comprising the roof structure; roof covering materials; and Report methods used to observe the roofing and attic. The home inspector is not required to: Walk on the roofing; or Observe attached accessories including but not limited to solar systems, antennae, lightning arrestors, or similar attachments; Enter attic spaces with headroom of less than 5 feet; or if there are obstructions; and other detrimental conditions.



garage attic



garage attic



garage attic



garage attic





master bedroom closet attic



master bedroom closet



master bedroom closet



master bedroom closet

**Styles & Materials**

**Viewed roof covering from:**

- Walked roof
- Ground
- Binoculars

Limitations: Some areas of the roof is to high for inspector's ladder to reach

**Roof Ventilation:**

- Soffit and Passive Vents
- Thermostatically controlled fan

**Attic Access Location/Info:**

- Scuttle hole located in:
- Master bedroom closet
- No Storage
- light in attic

**Roof-Type:**

Hip Dimensional

**Chimney (exterior):**

Brick

**Method used to observe attic:**

- From the furnace platform
- Partially Inaccessible due to insulation over ceiling joists
- Partially inaccessible due to access and ductwork
- Inaccessible areas were viewed with flashlight

**Roof Covering:**

- 3-Tab Composition
- Architectural shingles

**Sky Light(s):**

None

**2nd Attic Access**

- Location/Info:**
- Pull down ladder located in:
- Master Bathroom closet
- Garage Ceiling
- Partial storage
- light in attic

**Method used to observe 2nd attic:**

Walked  
 Partially Inaccessible due to insulation over ceiling joists  
 Inaccessible areas were viewed with flashlight

**Roof Structure:**

Wood trusses  
 2 X 4 Rafters  
 Wood Board Sheathing

**Ceiling Structure:**

Not visible due to insulation

**Attic Insulation:**

Fiberglass loose fill

		IN	NI	NP	C	RR
2.0	Roof Coverings - Asphalt	•				
2.1	Roof Flashings					•
2.2	Chimney/Flue Pipe (fireplace)- Roof Penetrations	•				
2.3	Roof Penetrations- Vents, Skylights, Etc	•				
2.4	Roof Drainage Systems (drip edge, gutters, downspouts, and splashblocks)					•
2.5	Attic Access					•
2.6	Roof Structure and Attic (Report leak signs or condensation)					•
2.7	Roof/Attic Ventilation	•				
2.8	Ventilation Fans and Thermostatic Controls (Attic)	•				
2.9	Attic Insulation	•				
2.10	Attic Electrical (Visible Electric Wiring in Attic, Switches, Outlets, and Light Fixtures)					•
2.11	Attic Plumbing	•				
2.12	General Notes	•				

IN= Inspected, NI= Not Inspected, NP= Not Present, C= Conditional, RR= Repair or Replace

**IN NI NP C RR**

**Comments:**

**2.1** (1) Some of the roof flashings are not visible for inspection due to building materials have hidden flashings that are never visible.



**2.1** (2) Where the wall and roof intersects at the top level of the home it is recommended that a 2 inch gap is needed between the siding and the roof to prevent water absorption to prevent the ends of the wood siding from deterioration. Cannot determine if a metal flashing has been installed. This area is more prone for water leakage which can lead to the deterioration of the wood structure and framing of the roof and damage to the wall framing if a flashing is not installed. Recommend a qualified roofing contractor further evaluate, correct and repair as needed to ensure water leakage does not occur and to prevent the wood siding from rotting underneath.



2.1 Item 1(Picture) front of home



2.1 Item 2(Picture) front of home



2.1 Item 3(Picture) rear of home

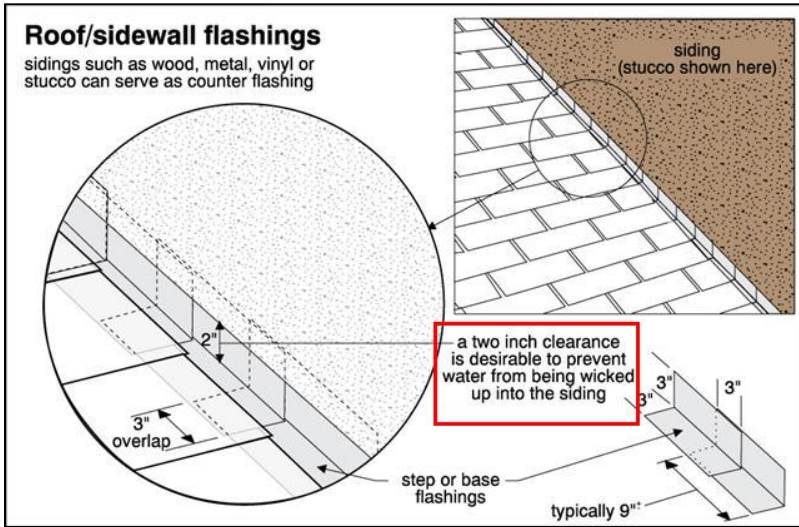

2.1 Item 4(Picture)

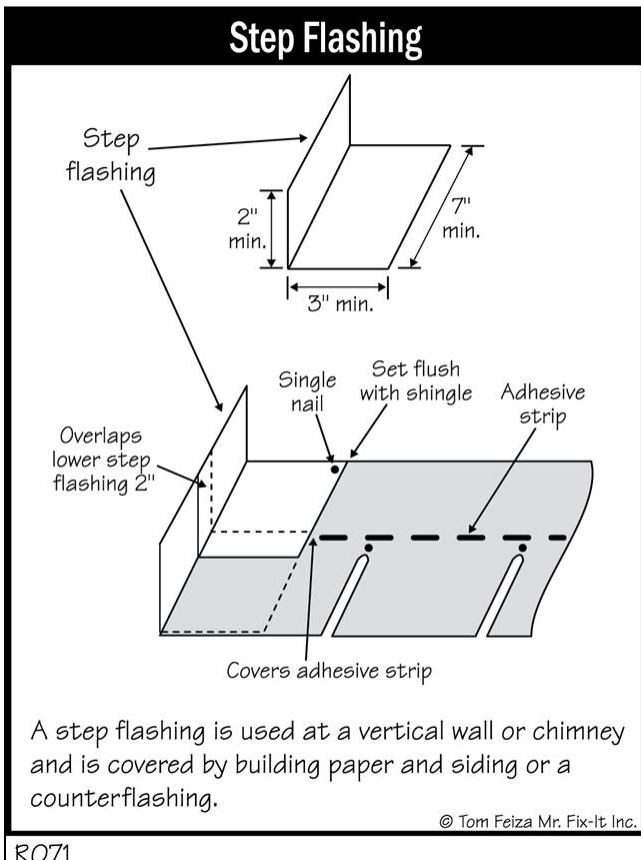

2.1 Item 5(Picture)

2.2 The height of the chimney prevented us from performing any type of inspection of the chimney cap, and interior of the chimney at this time.

**2.4** (1) The gutters where indicated in photos have mounting bolts that are loose at the left side of the home. If not corrected gutters can become detached from the fascia and also water can enter the soffits which can lead to wood rot. Recommend a qualified contractor repair loose gutters to avoid spilling roof runoff around perimeter of home.

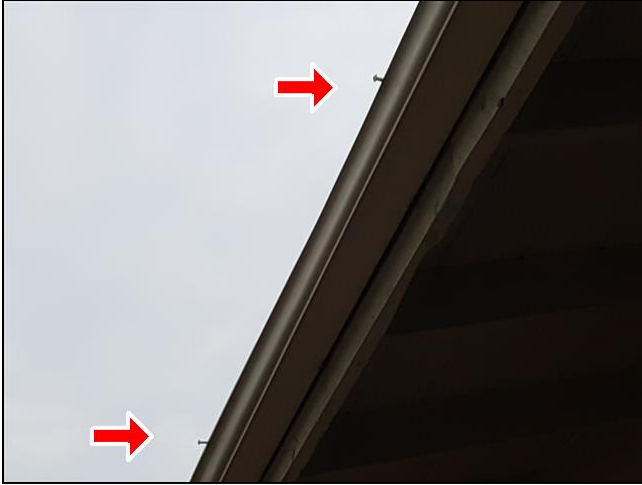

2.4 Item 1(Picture)

**2.4** (2) Recommend the downspout extension(s) be attached to the downspout at the front right corner of the home by placing a screw at the top and bottom where it connects to the downspout to ensure the extension(s) does not pull away from the downspout(s). Failing to do this may create future problems to the foundation around the home due to soil erosion and water entering the basement which may result in the foundation settlement if the extension detaches from the downspout.



2.4 Item 2(Picture)



2.4 (3) The downspout extension has deteriorated at the join at the front center of the home. Leakage maybe be experienced here when it rains which could lead to basement leakage. Recommend replacement as needed.



2.4 Item 3(Picture) front center of home

2.4 (4) Gutters and downspouts are missing at the top roof of the home and should be installed to prevent deterioration of the roof shingles below and to avoid spilling roof runoff around the building if current downspouts cannot adequately drain roof runoff efficiently- a potential source of water entry into the basement or water damage. Recommend a qualified contractor install a gutter system at the top level of the home. Ensure that the downspouts drain directly into the lower gutter and not on the roof.



2.4 Item 4(Picture)



2.4 Item 5(Picture) front of home



**2.4** (5) The gutter(s) where indicated in the photos, especially where they drain into the downspouts, are full of debris and need to be cleaned. The debris in gutters can also conceal rust, deterioration or leaks that are not visible until cleaned, and I am unable to determine if such conditions exist. Gutters require cleaning to avoid spilling roof runoff around the building - a potential source of water entry or water damage, and/or the fascia could become damaged. Recommend cleaning the gutters as needed. You may wish to consider installing gutter guards due to trees surrounding the home.



2.4 Item 6(Picture) front right corner of home



2.4 Item 7(Picture) rear left side of home



2.4 Item 8(Picture) right side of home

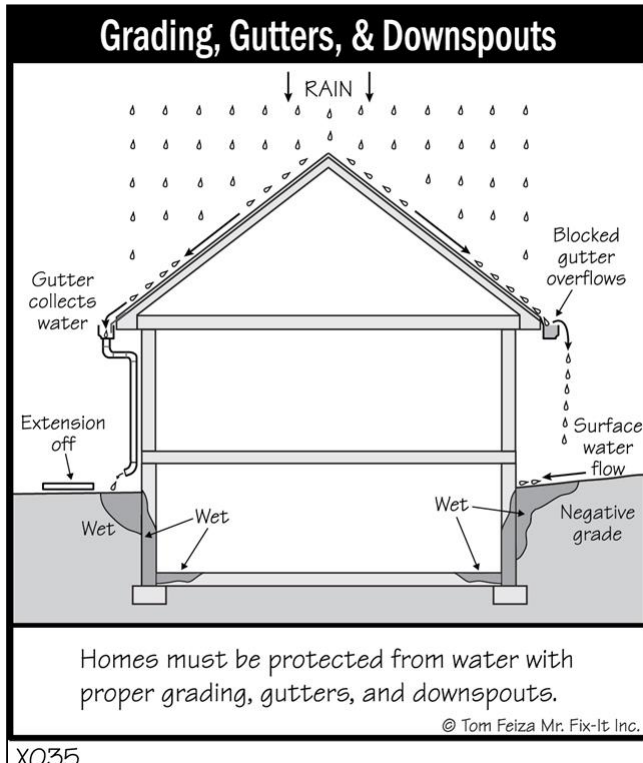

2.4 Item 9(Picture)

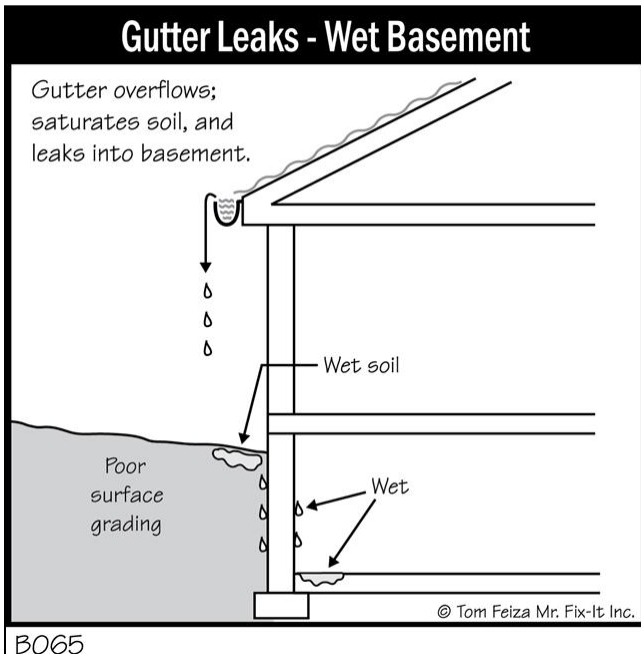

2.4 Item 10(Picture)

2.4 (6) The gutter needs to be tightened against fascia and sealed at the front left side of the home. This may cause water to pool in this area and may cause the gutter to pull away and detach from the fascia. Recommend a general contractor repair as needed.

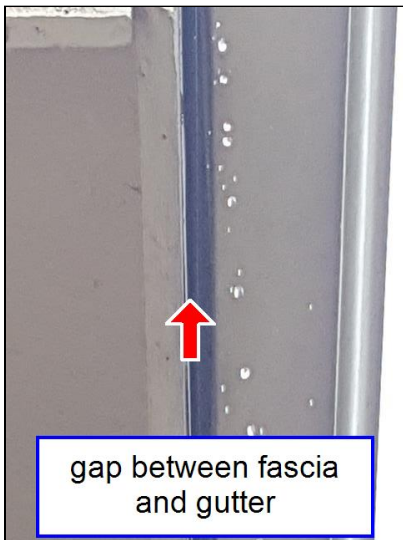

2.4 Item 11(Picture)



2.4 Item 12(Picture)

2.4 (7) The gutter leaks at the seam where indicated in the photos. Evidence of minor leakage was observed in this area during the inspection. Repairs are needed to prevent possible deterioration of the fascia and/or soffit via water intrusion. Recommend a general contractor repair as needed.

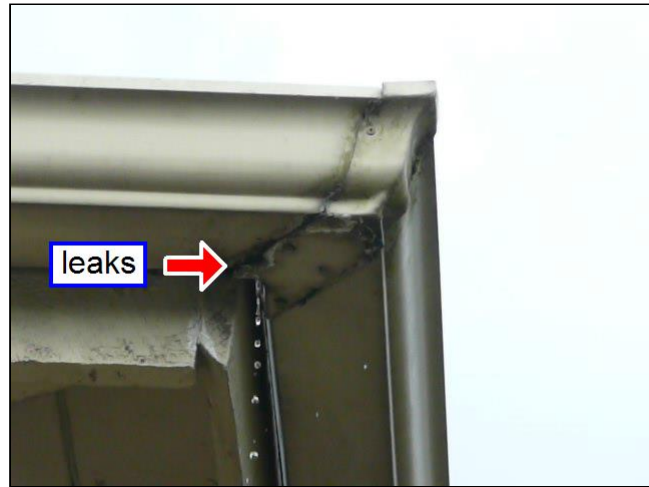

2.4 Item 13(Picture) rear right corner of home

2.4 Item 14(Picture) front left corner of home

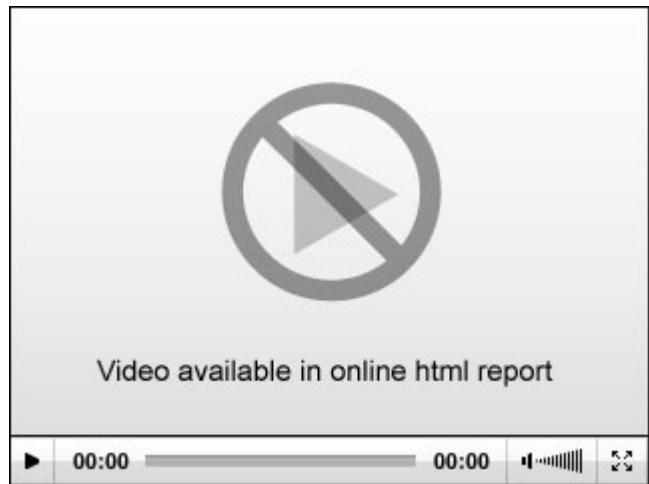
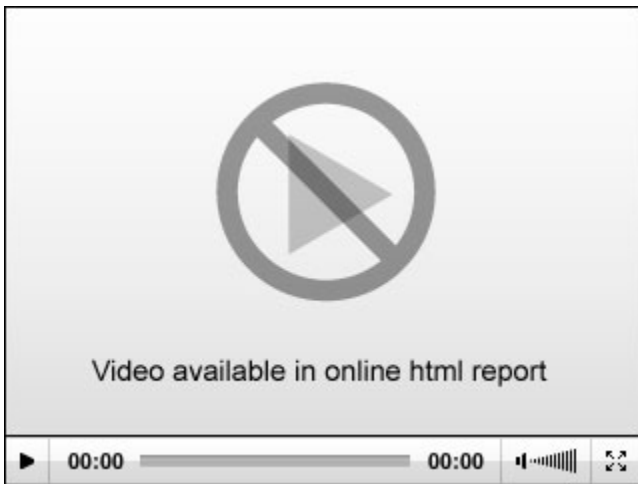

2.4 Item 15(Video) front left corner of home

2.4 Item 16(Video) rear right corner of home



2.5 (1) The pull down ladder in the garage is not assembled properly at the bottom stile, leaving the bottom stile unstable and not sitting flush against the mid stile for support against the floor. This is a safety issue. If it were to fail when someone is using it they could be severely hurt. Recommend that the stairs be repaired or replaced to prevent injuries.



2.5 Item 1(Picture)



2.5 Item 2(Picture)



2.5 Item 3(Picture)

2.5 (2) Recommend repairing the hole in the pull down ladder door.

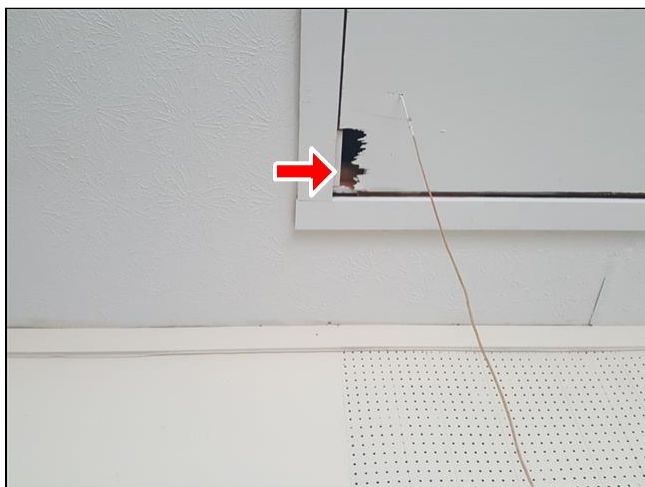

2.5 Item 4(Picture)

2.6 The 2x4 truss above the attic house fan has been cut/modified in the master bedroom attic area. The truss may fail if not repaired correctly. Excess loads on the roof like snow can cause separation if not reinforced. Truss repairs should be approved by an engineer or qualified architect before performing the work involved. Some reinforcement may be recommended by an engineer. For this reason, I **strongly** recommend you contact an engineer or qualified person for a second opinion before closing.

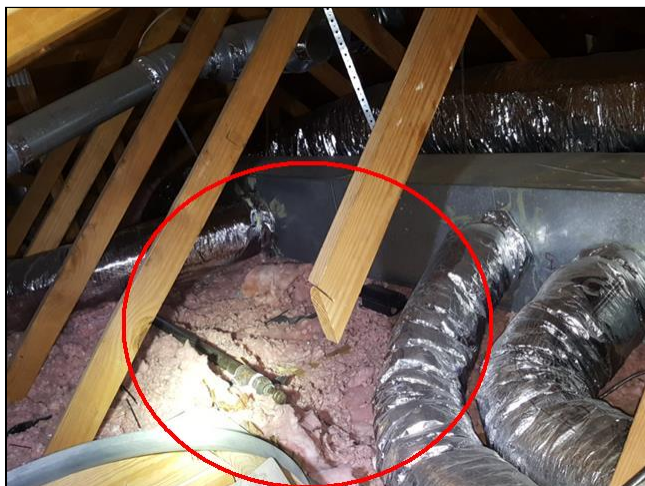

2.6 Item 1(Picture)



2.8 The attic house Fan in the ceiling at the upstairs hallway was working at the time of inspection. This is for your information.

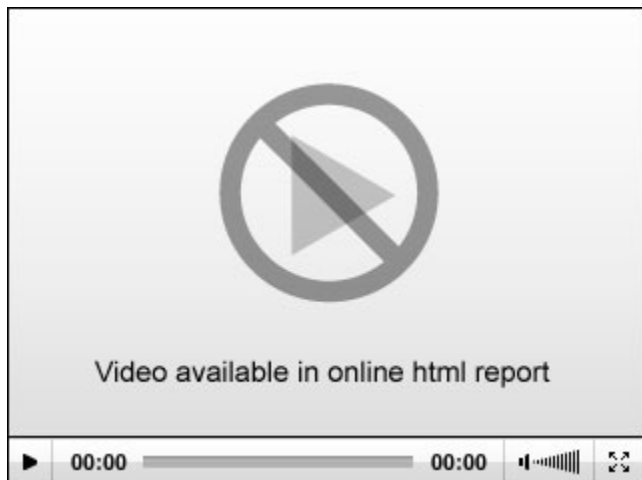

2.8 Item 1(Video)

2.9 The insulation is about ten inches thick or just over 30 R-Value.

2.10 (1) Loose wiring in the garage attic should be secured to prevent tripping accidents. This is a safety issue. Recommend a licensed electrician secure where needed.



2.10 Item 1(Picture) garage

**2.10 (2)** The wiring installation of the power vent in the garage attic is non-standard. It is suspected that an amateur, rather than a licensed electrician performed the installation. Splices in electrical wiring should be enclosed in junction boxes and fitted with cover plates, not covered in insulation tape. This is a safety issue. Recommend a licensed electrician repair as needed to prevent accidental electric shocks.

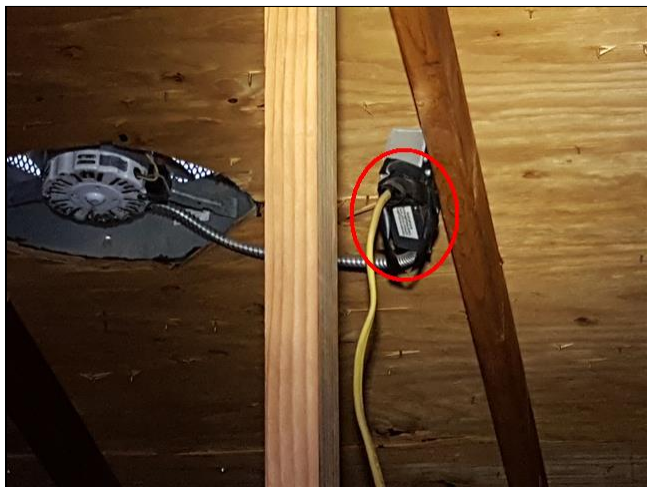

2.10 Item 2(Picture)

**2.12** For safety reasons, walking on the top roof exceeds the scope of a general home inspection as required by the Standards of Practice. To ensure the safety of the inspector it is our policy that readily visible areas of the roof surfaces and components are to be inspected from a safe vantage point using binoculars from the ground or ladder. This policy is in compliance with the Kentucky Board of Home Inspectors approved Standards of Practice.

---

The roof of the home was inspected and reported on with the above information. While the inspector makes every effort to find all areas of concern, some areas can go unnoticed. Roof coverings and skylights can appear to be leak proof during inspection and weather conditions. Our inspection makes an attempt to find a leak but sometimes cannot. Please be aware that the inspector has your best interest in mind. Any repair items mentioned in this report should be considered before purchase. It is recommended that qualified contractors be used in your further inspection or repair issues as it relates to the comments in this inspection report.

**3. Exterior**



The home inspector shall observe: Wall cladding, flashings, and trim; Entryway doors and a representative number of windows; Attached porches, decks, stairs, steps, landings, and applicable railings; Eaves, soffits, and fascias; and Vegetation, intrusive trees, grading, drainage, driveways, patios, walkways, and retaining walls with respect to their effect on the condition of the building. The home inspector shall: Describe wall cladding materials; Describe wall covering materials and type; material for driveways, walkways, and other items contiguous with the inspected structure; Operate and observe all entryway doors and a representative number of windows; and Probe exterior wood components where deterioration is suspected. The home inspector is not required to evaluate function of: Storm windows, storm doors, screening, shutters, awnings, and similar seasonal accessories; The home inspector is not required to observe: Fences; Evaluate the condition of; Trees, vegetation, Geological conditions, Soil conditions, and privacy walls; Recreational facilities (including spas, saunas, hot tubs, swimming pools, tennis courts, playground equipment, and other exercise, entertainment, or athletic facilities); Detached buildings or structures; test or inspect for; window glass type; integrity of thermal window seals; operation of security locks, devices, or systems; Evaluate the presence, extent and type of insulation and vapour barriers in exterior walls; or Presence or condition of buried fuel storage tanks. The home inspector is not required to: Move personal items, panels, furniture, equipment, plant life, soil, snow, ice or debris that obstructs access or visibility.

**Styles & Materials**

**Siding Material:**

Brick veneer  
and  
Wood siding

**Exterior Entry Doors:**

Metal Door  
Wood window door(s)  
Sliding Door

**Appurtenance:**

Covered porch with steps

**Driveway:**

Concrete  
Shared access

		IN	NI	NP	C	RR
3.0	Masonry Siding and Trim				•	
3.1	Wood Siding and Trim					•
3.2	Eaves, Soffits, Fascias and Paint	•				
3.3	Doors (Front and Rear Exterior)	•				
3.4	Windows				•	
3.5	Porches, Balconies, Areaways, Stoops, Steps, and Applicable Railings					•
3.6	Decks, Structure, Railings, Stairs					•
3.7	Driveways, Walkways (With respect to their effect on the condition of the building)				•	
3.8	Patio Floor, Covered Patio (With respect to their effect on the condition of the building)	•				
3.9	Retaining Walls (With respect to their effect on the condition of the building)	•				
3.10	Grading, Drainage, (With respect to their effect on the condition of the building)	•				
3.11	Vegetation, (With respect to their effect on the condition of the building)				•	
3.12	Plumbing Water Faucets (hose bibs)	•				
3.13	Outlets, Switches, Light Fixtures, (Exterior)	•				
3.14	General Comments	•				

IN= Inspected, NI= Not Inspected, NP= Not Present, C= Conditional, RR= Repair or Replace

**IN NI NP C RR**

**Comments:**

**3.0** Typical stair step cracks at the mortar joint in the brick siding at the right side of the home above the garage was observed. These cracks imply that the lintel may be rusting or expanding. A lintel is a metal beam supporting the masonry above an opening in a wall. It also may imply that minor settlement of the home has occurred. While the rate of movement cannot be predicted during a one-time inspection it is likely that repairs are needed. These cracks do not appear significant at this stage from a structural concern due to the width of the crack. Due to freeze/thaw (water entering), the cracks should be sealed to minimize further chipping away, flaking or deterioration. The lintel is covered. Recommend these cracks be sealed to prevent further cracking and possible deterioration of the brick work. A skilled masonry contractor should perform the repairs via re-pointing mortar. It is recommended that you monitor periodically and if cracks reappear further investigation by a structural engineer is recommend. Ensure the lintel is sealed so that water intrusion does not occur to prevent rusting of the lintel.

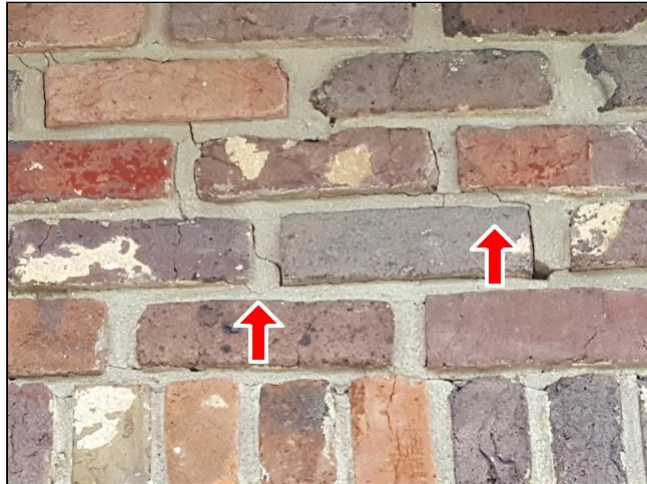

3.0 Item 1(Picture) right side of garage

3.0 Item 2(Picture) right side

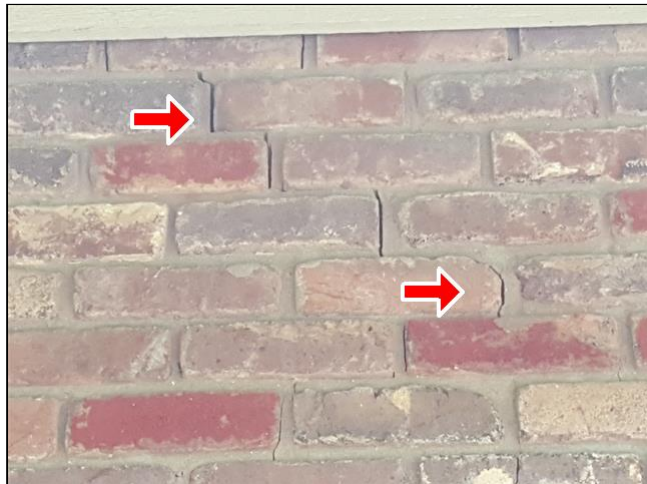

3.0 Item 3(Picture) left side

3.0 Item 4(Picture) left side



**3.1** (1) There is evidence of recent carpenter bee damage to the wood siding in some areas of the home. Carpenter bees have the ability to tunnel into the wood which can compromise the structure and cause damage via water intrusion. Recommend sealing holes where found around the perimeter of the home with the appropriate sealer, then consult a pest control specialist for advice on a possible treatment to prevent further damage and deterioration of the wood siding around the home. [Carpenter Bee Treatment and Repair](#)



3.1 Item 1(Picture)

**3.1** (2) The exterior walls are covered with Wood siding. This material deteriorates rapidly when exposed to moisture. Keep the siding well caulked and painted at all times. Recommend monitoring siding yearly to ensure surfaces are well sealed with paint and caulk where needed. This is for your information.

**3.1** (3) The wood siding has cracked and is loose in some areas at the front of the home. See photos for location. These areas need to be repaired or replaced to prevent further water intrusion which will lead to further deterioration of the siding and possible rotting. Over time deterioration of the wall sheathing and/or framing may occur and possible mold may occur. Recommend a qualified contractor further access damaged areas and repair or replace as needed.



3.1 Item 2(Picture) front right side of home

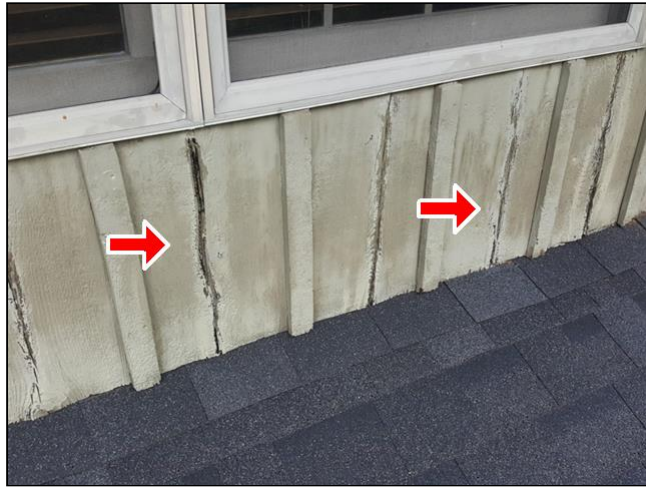

3.1 Item 3(Picture) front right side of home



3.1 Item 4(Picture) front left side of home

3.3 I would recommend a door sweep be installed at the basement door at the left side of the home to ensure water intrusion does not occur. This is for your information

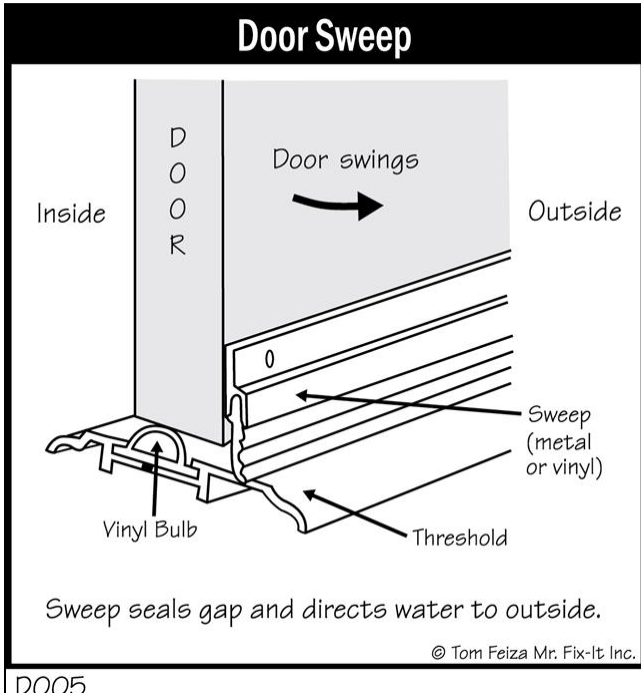

D005

3.3 Item 1(Picture)

3.4 (1) The gaps between the window frames and the siding around the home need to be sealed correctly to prevent water intrusion. Water entering here can lead to deterioration of the wall siding and potential leaks inside the wall cavity. Recommend caulking these areas with a quality moisture resistant caulk that expands and contracts. [Choosing the right caulk](#)



3.4 Item 1(Picture)

3.4 Item 2(Picture)

**3.4** (2) The window frame at the rear right side of the home has cracked sealant between the siding and the window frame. Water and/or insects may enter and deterioration may occur behind the wall cavity and siding. This is a small repair. Recommend re-caulking as needed. [Which caulk to use](#)



3.4 Item 3(Picture)



3.5 (1) The guard rail for the balcony porch on the right side of the home have large spaces between the ballusters. This is a safety issue. A fall or injury could occur if not corrected as this condition could allow a child or pet to fall through which may result in a death. The current recommendations are for spacing to be no more than 4" to prevent these accidents. A qualified contractor should make the necessary repairs and corrections where needed for safety.



3.5 Item 1(Picture)

3.5 Item 2(Picture)

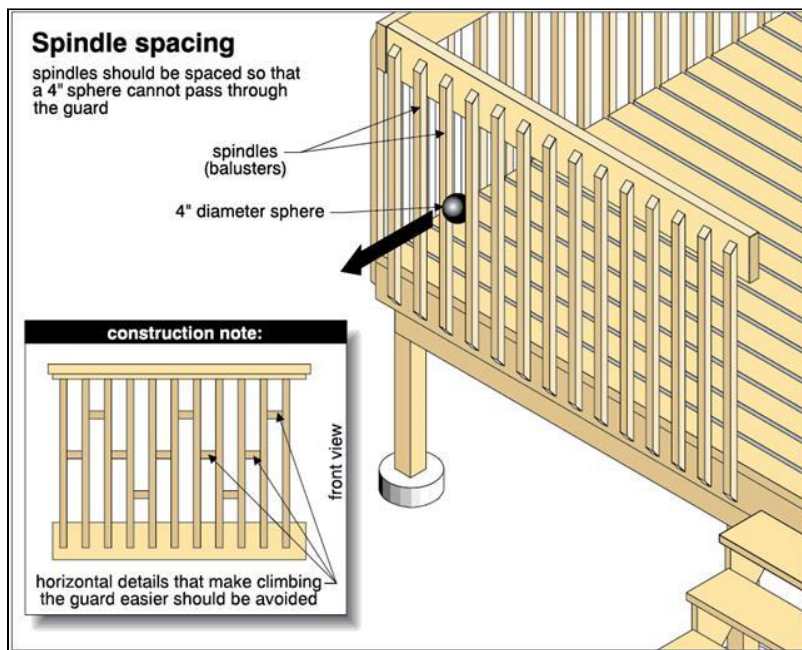

3.5 Item 3(Picture)

**3.5 (2)** Recommend a guard rail be installed at the front porch on the right side to prevent a fall from occurring which may result in an injury of a person. This is a potential safety issue. The railing needs to be at least 36 inches high and balusters need spacing to be at least 4 inches. Recommend a qualified contractor install one for safety.



3.5 Item 4(Picture) front right side of home

**3.5 (3)** 2x6s are installed for handrails for the basement staircase at the left side of the home and are not considered "gripable" by industry standards. This is a safety issue and an injury could occur if not corrected. Recommend that a standard approved handrail be installed for safety by a general contractor.



3.5 Item 5(Picture)

**3.5** (4) The staircase at the front porch has sunken on the left side. The staircase may be in contact with the ground. This may become a possible safety issue if further settlement occurs. Recommend replacement or repair as needed by a qualified contractor.



3.5 Item 6(Picture)



**3.6** (1) The guard rail for the rear deck and the staircase have large spaces between the ballusters. This is a safety issue. A fall or injury could occur if not corrected as this condition could allow a child or pet to fall through which may result in a death. The current recommendations are for spacing to be no more than 4" to prevent these accidents. A qualified contractor should make the necessary repairs and corrections where needed for safety.



3.6 Item 1(Picture)



3.6 Item 2(Picture)



3.6 Item 3(Picture)



**3.6 (2)** 2x4s are installed for handrails for the deck staircase and are not considered "gripable" by industry standards. This is a safety issue and an injury could occur if not corrected. Recommend that a standard approved handrail be installed for safety by a general contractor.



3.6 Item 4(Picture)

**3.6 (3)** The guard rail for rear deck is loose, unstable and not secured properly. This is extremely dangerous and is a major safety concern. It may fail under a medium or heavy force or if someone was pushed against or was leaning on the railing. For your safety it should be strengthened and secured. Recommend a qualified contractor repair as needed before closing.



3.6 Item 5(Picture)



3.6 Item 6(Picture)

3.6 (4) Recommend a guard rail be installed for the staircase at the rear right side of the home to prevent a fall from occurring which may result in an injury of a person. This is a potential safety issue. The railing needs to be at least 36 inches high and balusters need spacing to be at least 4 inches. Recommend a qualified contractor install one for safety.



3.6 Item 7(Picture)

3.6 (5) The support posts for the deck/balcony are 4x4s. This was common when this home was built. 6x6 posts are now recommended for structural support for decks and balconies. There were no issues noted during the inspection, however I would recommend monitoring posts annually and at the first sign of posts leaning, strongly recommend a qualified contractor repair or replace post to ensure structural integrity of the deck/balcony. This is for your information.



3.6 Item 8(Picture)



3.6 Item 9(Picture)

**3.6** (6) The bottom of the deck steps are in contact with the soil at the rear right side of the home. The stairs need to be resting on a concrete landing. Over time the soil will erode away and weaken the bottom of the staircase and will not be supported. In the future this will result in being a safety issue and an injury could occur. Recommend correcting as needed by a general contractor or qualified person.



3.6 Item 10(Picture)

**3.7** Common settlement crack(s) were noted at the concrete drive. This is not a tripping hazard as yet at this time. I also do not see these small cracks as an indication of a structural issue. Further deterioration and/or settlement can occur to the driveway via water intrusion if not repaired. Recommend repairs via a masonry caulk as needed then monitor annually. Here is a link for [Sealing Concrete Cracks](#)



3.7 Item 1(Picture)



**3.10** The installation of a drain is recommended for the basement entry door at the left side of the home. The drain should be arranged to effectively drain water from the basement door while resisting clogging. Basement entry runoff must be directed away from the building to avoid water entry/damage to the basement and to prevent water entering the foundation perimeter. You may wish to consult a qualified contractor for advice on how to achieve this.



3.10 Item 1(Picture)

**3.11** (1) Vegetation should not be in contact with the home, especially dense foliage and ivy. Plants can hold moisture against the building, slow down the drying effect of circulating air and they provide a hiding place for rodents. All vegetation needs to be kept neatly trimmed and away from the foundation, wall siding, and window frames to prevent damage to the home and allow proper venting and inspection of house. A 6" clearance is recommended. This is for you information for future reference.

**3.11** (2) There are tree branches that overhang over the roof at the front right corner of the home. Be observant. Tree limbs should be cut as needed to prevent damage to the shingles and from scraping on the roof surface. They will also clog gutters which will cause water run off problems around the home. Recommend cutting back tree branches as needed.



3.11 Item 1(Picture)

**3.13** The exterior outlet(s) of the home are GFCI protected however when tripped you need to reset them at the panel box at the appropriate breaker No. 10. This is for your information.



**3.14 (1)** Please note our company does not inspect pools however it is recommended for safety that a fence be installed around the perimeter of the pool and a gate to prevent an accidental death of a child via drowning if they were to fall in. Ensure the fencing surrounding the property and exterior gates leading into back yard are always kept in perfect condition and working order. This is for your information.



3.14 Item 1(Picture)



3.14 Item 2(Picture)



3.14 Item 3(Picture)

**3.14** (2) Common settlement crack(s) were noted at the patio floor near the pool area. This has caused a slope which allows water to pool and not drain correctly. Water pooling here can lead to the retaining wall to settle or lean in the future. Recommend a qualified masonry contractor repair as needed. Consideration for improving drainage in this area is also recommended. Further deterioration and/or settlement can occur to the concrete floor via water intrusion if not repaired.



3.14 Item 4(Picture)

---

The exterior of the home was inspected and reported on with the above information. While the inspector makes every effort to find all areas of concern, some areas can go unnoticed. Please be aware that the inspector has your best interest in mind. Any repair items mentioned in this report should be considered before purchase. It is recommended that qualified contractors be used in your further inspection or repair issues as it relates to the comments in this inspection report.

## 4. Garage/Carport

The home inspector shall observe: Exterior and interior walls and ceilings, floors, windows, doors, roof, and foundation; Electrical system and components; Plumbing system and components; Garage door operators; The home inspector shall: Describe type and material of doors, exterior and interior walls, and roof; Operate garage doors manually or by using permanently installed controls for any garage door operator; Report whether or not any garage door operator will automatically reverse or stop when meeting reasonable resistance during closing; The home inspector is not required to observe: Garage door operator remote control transmitters; The home inspector is not required to: Move personal items, panels, furniture, or equipment that obstructs access or visibility.



### Styles & Materials

**Garage Insulation:**

NONE

**Garage Door Type / Material:**

One automatic  
Metal  
Insulated  
Glass inserts

**Auto-opener Manufacturer:**

SEARS  
1/2 HORSEPOWER

**Ceiling Materials:**

Drywall

**Wall Material:**

OSB Board  
Extra Info : painted

**Floor Material/Covering(s):**

Concrete

**Door to Interior:**

Metal

**Door to Exterior:**

Metal

**Window Types:**

Wooden Frames  
Double-hung  
Thermal/Insulated

		IN	NI	NP	C	RR
4.0	Garage Ceiling	•				
4.1	Garage Walls	•				
4.2	Garage Floor	•				
4.3	Garage Door/Operators (Report whether or not doors will reverse when met with resistance)					•
4.4	Garage Window (s)	•				
4.5	Occupant Door from Garage to inside home	•				
4.6	Occupant Door from Garage to Exterior of Home	•				
4.7	Steps, Stairways, Balconies and Railings					•

IN= Inspected, NI= Not Inspected, NP= Not Present, C= Conditional, RR= Repair or Replace

**IN NI NP C RR**

		IN	NI	NP	C	RR
4.8	Connected Devices and Fixtures (Observed from a representative number operation of ceiling fans, lighting fixtures, switches and receptacles)					•
4.9	General Info	•				

IN= Inspected, NI= Not Inspected, NP= Not Present, C= Conditional, RR= Repair or Replace

IN NI NP C RR

**Comments:**

4.2 There are no control joints in the garage floor. All concrete cracks. Control joints allow poured concrete to crack at the joint to prevent large running cracks. Recommend adding control joints by a qualified contractor.

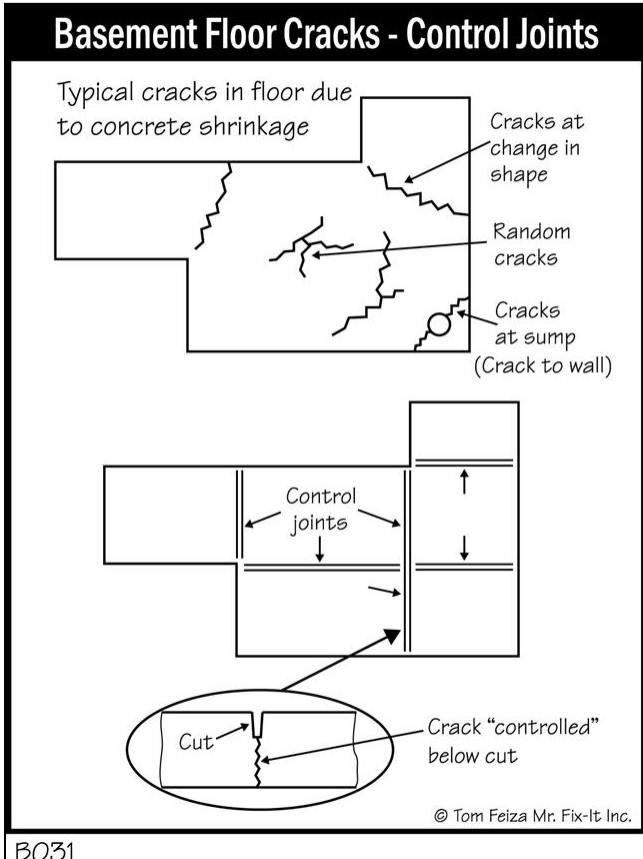

B031

4.2 Item 1(Picture)



4.3 (1) The door button is lower than the manufacturers recommended 5 feet above the floor. This is a safety issue. Recommend this be raised to prevent unauthorized use by children as an injury may occur or damage to a motor vehicle when the door is opened or closed automatically. A qualified licensed electrician is recommended for correcting.



4.3 Item 1(Picture)

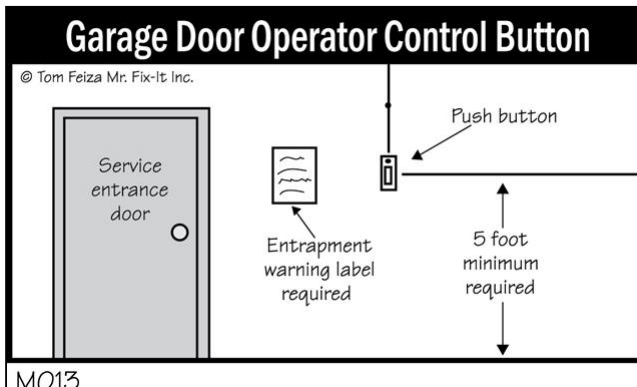

4.3 Item 2(Picture)

4.3 (2) The garage door opener electric eyes are installed too high. There is a serious risk of injury, particularly to children or pets, under this condition. The eyes should be placed 4" to 6" off the floor or as otherwise indicated in the installation manual. This should be dealt with immediately by a qualified garage installer.

Note: the door does reverse when eyes are interrupted and under resistance.



4.3 Item 3(Picture)

4.5 Recommend the door between the garage and the interior of the house be equipped with an auto-closer device to prevent automobile fumes from entering the house. This is for your information.

**4.7** Recommend a guard rail be installed at the staircase in the garage to prevent a fall from occurring which may result in an injury of a person. This is a potential safety issue. The railing needs to be at least 36 inches high and balusters need spacing to be at least 4 inches. Recommend a qualified contractor install one for safety.



4.7 Item 1(Picture)

**4.8** (1) The outlets in the garage are not GFCI protected. GFCI (Ground fault circuit interrupters) outlets should be considered for installation as a safety upgrade in all locations where water is present if the outlets are not presently connected to a GFCI. They are now required in all bathrooms, kitchen, unfinished basements, garages, exterior outlets, or other locations within 6' of a water source or sink. GFCI outlets may not have been required when this house was built but should be considered for safety. This is for your information. Personally recommend a licensed electrician replace as needed.

4.8 (2) Openings between the outlet and the cover plate in the garage where indicated in the photo is a serious safety issue. A child or person may place an object inside opening which may contact the connecting wires causing an electrical shock which could lead to a serious injury or death. Recommend a qualified electrician repair as needed for your safety before moving into home.



4.8 Item 1(Picture)

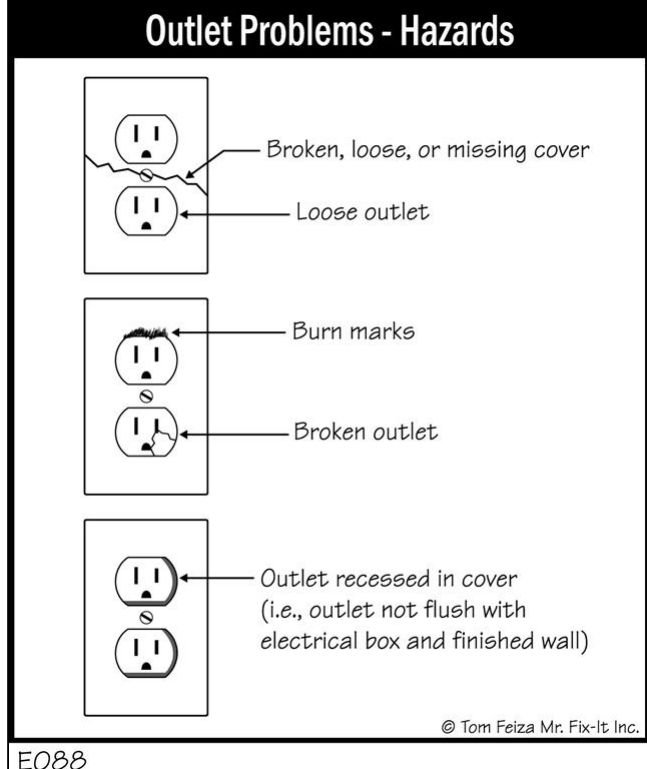

4.8 Item 2(Picture)

4.8 (3) The outlet(s) in the garage where indicated in the photo(s) are loose in the ceiling and is missing a cover plate. Electrical issues are considered a hazard until repaired. This is a safety issue that needs to be corrected due to an electric shock or fire from loose connections could occur if not repaired. Recommend a qualified licensed electrical contractor correct as needed.

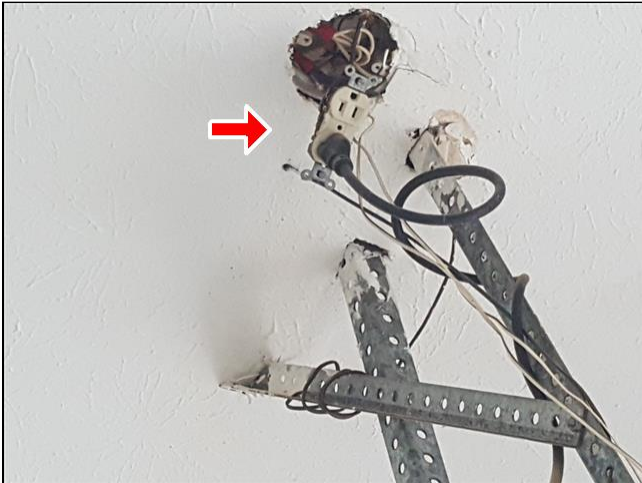

4.8 Item 3(Picture)

**4.9 Note:** Limited Inspection of the garage was performed due to excessive personal property, unable to view most of the walls, slab and access switches and outlets. Recommend further inspection of these item(s) / areas prior to closing.



4.9 Item 1(Picture)



4.9 Item 2(Picture)

---

The garage of the home was inspected and reported on with the above information. While the inspector makes every effort to find all areas of concern, some areas can go unnoticed. Please be aware that the inspector has your best interest in mind. Any repair items mentioned in this report should be considered before purchase. It is recommended that qualified contractors be used in your further inspection or repair issues as it relates to the comments in this inspection report.



**5(A) . Kitchen / Components and Appliances Main Kitchen**



The home inspector shall observe and operate the basic functions of the following kitchen appliances: Permanently installed dishwasher, through its normal cycle; Range, cook top, and permanently installed oven; Garbage disposal; Ventilation equipment or range hood; and Permanently installed microwave oven; Observe kitchen cabinets and countertops; Walls, ceiling, and floors; Interior water supply and distribution system, including: piping materials, supports, and insulation; fixtures and faucets; functional flow; leaks; and cross connections; Interior drain, waste, and vent system, including: traps; drain, waste, and vent piping; piping supports and pipe insulation; leaks; and functional drainage; Operate all plumbing fixtures, The operation of a representative number of installed ceiling fans, lighting fixtures, switches and receptacles; The operation of ground fault circuit interrupters; The polarity and grounding of all receptacles within six feet of interior plumbing fixtures, The home inspector is not required to observe: Clocks, timers, self-cleaning oven function, or thermostats for calibration or automatic operation; Non built-in appliances; Paint, wallpaper, and other finish treatments on the interior walls, ceilings, and floors; Carpeting; or Draperies, blinds, or other window treatments. The home inspector is not required to operate: Any water shut off valves; Appliances in use; or Any appliance that is shut down or otherwise inoperable.



washer dryer room

**Styles & Materials**

**Dishwasher Brand:**

BOSCH

Serial # Model# : #FD9402

00482 #SHX7ER55UC/74

**Disposer Brand:**

BADGER

Serial # Model # :

#15011683954

**Range/Oven Fuel Type and Brand:**

GAS

FRIGIDAIRE

THERMADOR

Serial # Model # : STOVE #941100022 #SGS305FS/04

OVEN #AF43602823 #FPEW3085PFC

**Exhaust/Range hood:**

RE-CIRCULATE

**Built in Microwave Vent**

**Type and Brand:**

**Refrigerator Brand:**

LG

UNKNOWN BRAND

LG

Serial # Model # Year # : #403TRCN2G923

Model # : N/A

Serial # Model# : #N/A #LFX28968ST/03 #2014

**Cabinetry:**

Wood

**Countertop:**

Corian

**Washer and Dryer:**

NOT INSPECTED

**Clothes Dryer Vent Material:**

Flexible Metal

**Dryer Power Source:**

Gas Connection

Propane Connection

		IN	NI	NP	C	RR
5.0.A	Plumbing Water Supply, Faucets, Shutoffs, and Fixtures	•				
5.1.A	Plumbing Drain and Vent Systems					•
5.2.A	Dishwasher					•
5.3.A	Food Waste Disposer	•				
5.4.A	Ranges/Ovens/Cooktops	•				
5.5.A	Range Hood	•				
5.6.A	Microwave Cooking Equipment	•				
5.7.A	Refrigerator	•				
5.8.A	Pantry/Closet Doors	•				
5.9.A	Counters and a representative number of Cabinets				•	
5.10.A	Outlets, GFCI (Ground Fault Circuit Interrupters), Wall Switches and Fixtures (Lights and Ceiling Fans)					•
5.11.A	Clothes Dryer Vent Piping				•	

IN= Inspected, NI= Not Inspected, NP= Not Present, C= Conditional, RR= Repair or Replace

IN NI NP C RR

**Comments:**

**5.1.A** The p-trap on the waste line is leaking at the connection underneath the sink in the kitchen. Repairs are needed to stop leaking water from damaging the cabinet bottom or to eliminate moisture that may contribute to fungi growth. A qualified licensed plumber is recommended for repairs as needed.

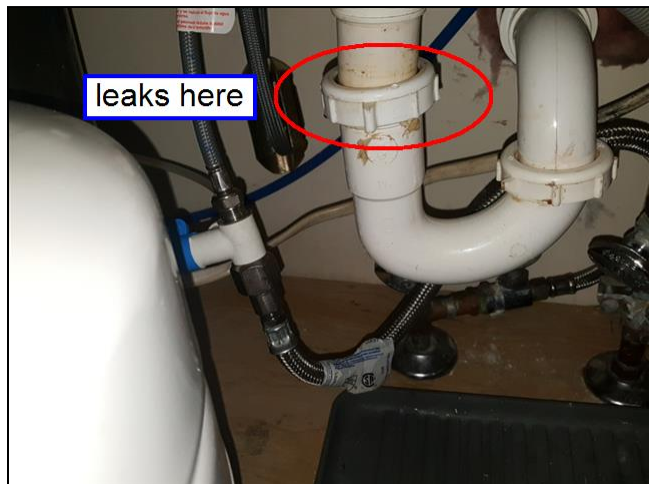

5.1.A Item 1(Picture)

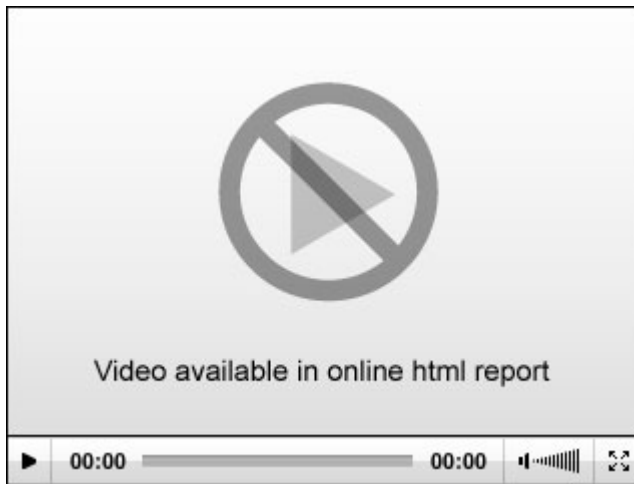

5.1.A Item 2(Video)

**5.2.A** The dishwasher drain hose did not perform a loop to create a trap under the sink. The current recommendations for the dishwasher drain lines are for them to be installed as close to the bottom of the countertop as possible. This creates a water blockage to prevent sewer gases entering the house through the dishwasher. Recommend repair or replace as necessary.

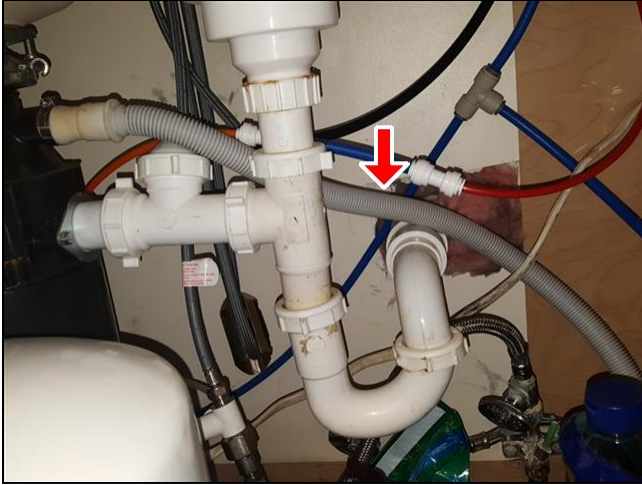

5.2.A Item 1(Picture)

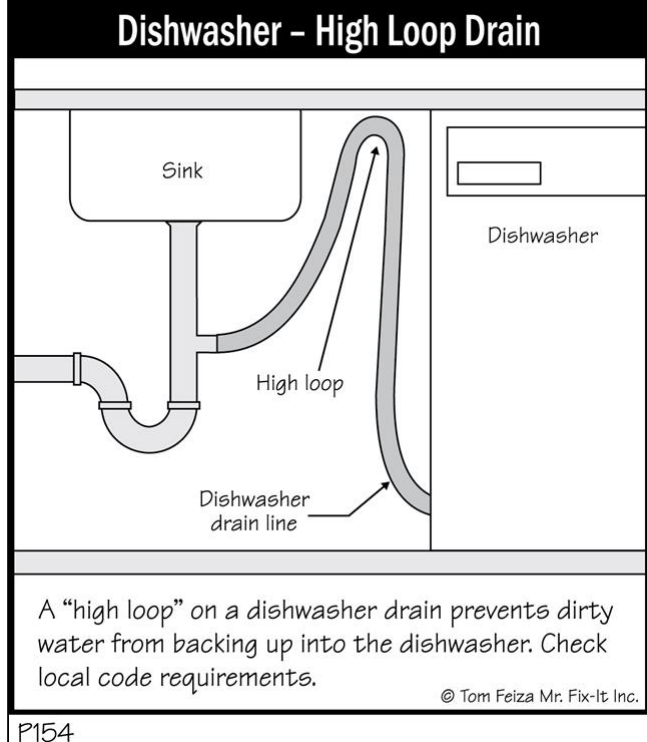

5.2.A Item 2(Picture)

**5.5.A** The data plate was not present on the range hood cabinet at the time of inspection.

**5.6.A** The data plate was not present on the micro wave at the time of inspection.

**5.9.A** Recommend caulking around the counter top in the kitchen to seal the gap/crack in front of the sink. Water may enter which can cause damage to the drywall and cabinets, then result in possible mold forming. Repair using a quality caulk that is resistant to moisture and is expandable. Here is a link on [How to Choose the right Caulk](#)



5.9.A Item 1(Picture)

**5.10.A** (1) I could not identify or inspect the outlet for refrigerator. I do not move refrigerators in order to access the outlet.

**5.10.A (2)** The outlet(s) are not GFCI protected in the kitchen in the home. Although GFCIs may not have been required at the time that this house was built, these are now required and recommended for safety within any water source as a safety feature when any changes to the outlets are made. GFCI outlet offers protection from shock or electrocution. Recommend a licensed electrician correct as needed prior to moving in.

**5.10.A (3)** The outlet(s) in the kitchen where indicated in the photo(s) are loose at the wall or in the outlet box. Electrical issues are considered a hazard until repaired. This is a safety issue that needs to be corrected due to an electric shock or fire from loose connections could occur if not repaired. Recommend a qualified licensed electrical contractor correct as needed.

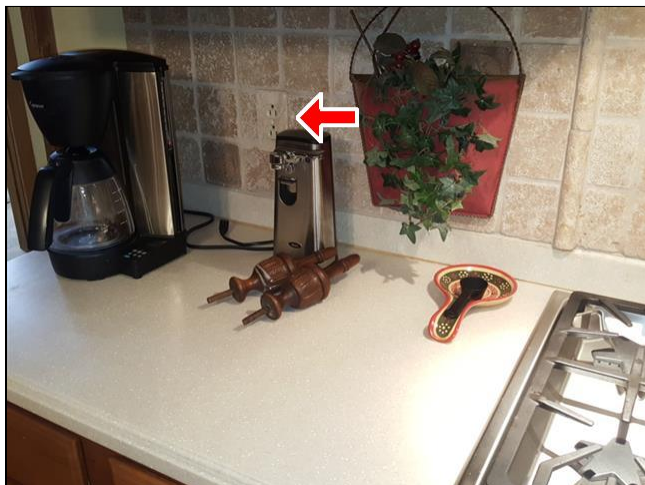

5.10.A Item 1(Picture)

**5.11.A (1)** The exterior port for the dryer vent pipe is located on the rear right side of the home. (see photo for location) This is for your information.



5.11.A Item 1(Picture)



**5.11.A** (2) The dryer vent piping is damaged. This can cause an obstruction of lint that has a possibility to create a fire hazard. Recommend replacing flexible line prior to using dryer.



5.11.A Item 2(Picture)

---

The Kitchen area of the home was inspected and reported on with the above information. While the inspector makes every effort to find all areas of concern, some areas can go unnoticed. Please be aware that the inspector has your best interest in mind. Any repair items mentioned in this report should be considered before purchase. It is recommended that qualified contractors be used in your further inspection or repair issues as it relates to the comments in this inspection report.

**5(B) . Kitchen / Components and Appliances Basement Kitchen**



The home inspector shall observe and operate the basic functions of the following kitchen appliances: Permanently installed dishwasher, through its normal cycle; Range, cook top, and permanently installed oven; Garbage disposal; Ventilation equipment or range hood; and Permanently installed microwave oven; Observe kitchen cabinets and countertops; Walls, ceiling, and floors; Interior water supply and distribution system, including: piping materials, supports, and insulation; fixtures and faucets; functional flow; leaks; and cross connections; Interior drain, waste, and vent system, including: traps; drain, waste, and vent piping; piping supports and pipe insulation; leaks; and functional drainage; Operate all plumbing fixtures, The operation of a representative number of installed ceiling fans, lighting fixtures, switches and receptacles; The operation of ground fault circuit interrupters; The polarity and grounding of all receptacles within six feet of interior plumbing fixtures, The home inspector is not required to observe: Clocks, timers, self-cleaning oven function, or thermostats for calibration or automatic operation; Non built-in appliances; Paint, wallpaper, and other finish treatments on the interior walls, ceilings, and floors; Carpeting; or Draperies, blinds, or other window treatments. The home inspector is not required to operate: Any water shut off valves; Appliances in use; or Any appliance that is shut down or otherwise inoperable.



basement washer dryer room

**Styles & Materials**

**Dishwasher Brand:**  
NONE

**Disposer Brand:**  
NONE

**Range/Oven Fuel Type and Brand:**  
ELECTRIC  
AGED  
GENERAL ELECTRIC  
Serial # Model # : #FV126537G #JBS030K2AD

**Exhaust/Range hood:**  
AGED  
RE-CIRCULATE  
UNKNOWN BRAND  
Model # : #N/A

**Built in Microwave Vent Type and Brand:**  
NONE

**Refrigerator (Basement):**  
MAYTAG  
Serial # Model # Year # : #10575508JL  
#MFI2568AEQ #N/A

**Cabinetry:**  
Wood

**Countertop:**  
Wood with laminate top

**Washer and Dryer:**  
NOT INSPECTED

**Clothes Dryer Vent Material:**  
Flexible foil

**Dryer Power Source:**  
Gas Connection  
Propane Connection

		IN	NI	NP	C	RR
5.0.B	Plumbing Water Supply, Faucets, Shutoffs, and Fixtures					•
5.1.B	Plumbing Drain and Vent Systems					•

IN= Inspected, NI= Not Inspected, NP= Not Present, C= Conditional, RR= Repair or Replace

**IN NI NP C RR**

		IN	NI	NP	C	RR
5.2.B	Ranges/Ovens/Cooktops					•
5.3.B	Range Hood	•				
5.4.B	Refrigerator	•				
5.5.B	Counters and a representative number of Cabinets	•				
5.6.B	Outlets, GFCI (Ground Fault Circuit Interupters), Wall Switches and Fixtures (Lights and Ceiling Fans)					•
5.7.B	Clothes Dryer Vent Piping					•

IN= Inspected, NI= Not Inspected, NP= Not Present, C= Conditional, RR= Repair or Replace

**IN NI NP C RR**

**Comments:**

**5.0.B (1)** The hot and cold water lines are connected to the faucets at the sink in reverse from there normal positions in the basement kitchen. This could result in scalding burns. Recommend they be changed to the accepted normal locations with the cold water valve on the right side of the fixture. Recommend a licensed plumber correct as needed.



5.0.B Item 1(Picture)

**5.0.B** (2) Your washing machine is connected to rubber hoses. These hoses are under constant water pressure and are prone to leaks or even bursting overtime. This will cause damage to your home. You may wish to convert hoses to "No-burst hoses" which are encased in a woven metal sleeve that prevents weak spots in the rubber from developing into leaks. This is for your information.



5.0.B Item 3(Picture)

5.0.B Item 2(Picture)

### Flood-Proof Washer Hoses

Reinforced flexible hoses (under pressure)

Clothes washer

Turn "off" here

Water is almost always "on"

The hoses connected to your clothes washer are always pressurized (unless you turn the valve off.) Use special reinforced hoses or hoses that automatically turn off if they sense a leak.

© Tom Feiza Mr. Fix-It Inc.

M064

5.0.B Item 4(Picture)



**5.1.B** The waste line is leaking at the connection underneath the left sink in the basement kitchen. Repairs are needed to stop leaking water from damaging the cabinet bottom or to eliminate moisture that may contribute to fungi growth. A qualified licensed plumber is recommended for repairs as needed.

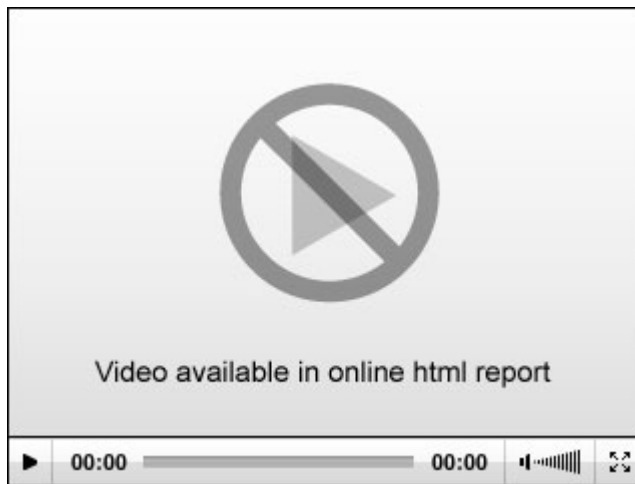

5.1.B Item 1(Picture)

5.1.B Item 2(Video)

**5.2.B** The "Anti Tip" bracket for the range has not been installed as required by manufacturer's installation instructions. This could allow the range to tip if it is pulled or if the oven door is pushed down or stepped on. This is a safety issue. A tip over hazard exists for small children and a serious injury or death could occur. Strongly recommend the bracket be installed for safety around small children or others. [Information about "anti tip" bracket](#)



5.2.B Item 1(Picture)

**5.3.B** The data plate was not present on the range hood cabinet at the time of inspection.

**5.4.B** The refrigerator does have a water supply line connected to it. The ice maker was turned off at time of inspection. Therefore the ice dispenser was not inspected. The water dispenser does work. This is for your information.

**5.6.B** (1) I could not identify or inspect the outlet for refrigerator. I do not move refrigerators in order to access the outlet.

**5.6.B** (2) The outlets in the basement kitchen are not GFCI protected. GFCI (Ground fault circuit interrupters) outlets should be considered for installation as a safety upgrade in all locations where water is present if the outlets are not presently connected to a GFCI. They are now required in all bathrooms, kitchen, unfinished basements, garages, exterior outlets, or other locations within 6' of a water source or sink. GFCI outlets may not have been required when this house was built but should be considered for safety. Personally recommend a licensed electrician replace as needed.







5.6.B Item 1(Picture)

**5.7.B** (1) A pleated Foil flex pipe is currently installed from the dryer to the exhaust vent. The current recommendations are for dryer vents to be heavy flexible or solid metal to help prevent crushing and damage from fires. Dryer lint fires are reported to be the third leading cause of fires. Exhaust ducts should be constructed of minimum 0.016 inch thick rigid metal ducts, having smooth interior surfaces with joints running in the direction of air flow. Exhaust ducts shall not be connected with sheet metal screws or fastening means which extend into the duct. All dryer vents should be disconnected and cleaned twice a year. This is a very common cause of fires. Recommend replacing duct for proper operation and for your safety using a qualified contractor.



5.7.B Item 1(Picture)

Choose these	Avoid these
 <p data-bbox="121 1033 446 1102"><b>RIGID METAL</b> These are least likely to sag.</p>	 <p data-bbox="560 1033 901 1123"><b>FLEXIBLE PLASTIC</b> These are likely to sag and trap lint.</p>
 <p data-bbox="121 1503 446 1593"><b>FLEXIBLE METAL</b> Also good, these hold their shape if bent.</p>	 <p data-bbox="560 1503 901 1593"><b>FLEXIBLE FOIL</b> These may look like flexible metal but don't hold their shape if bent.</p>

5.7.B Item 2(Picture)



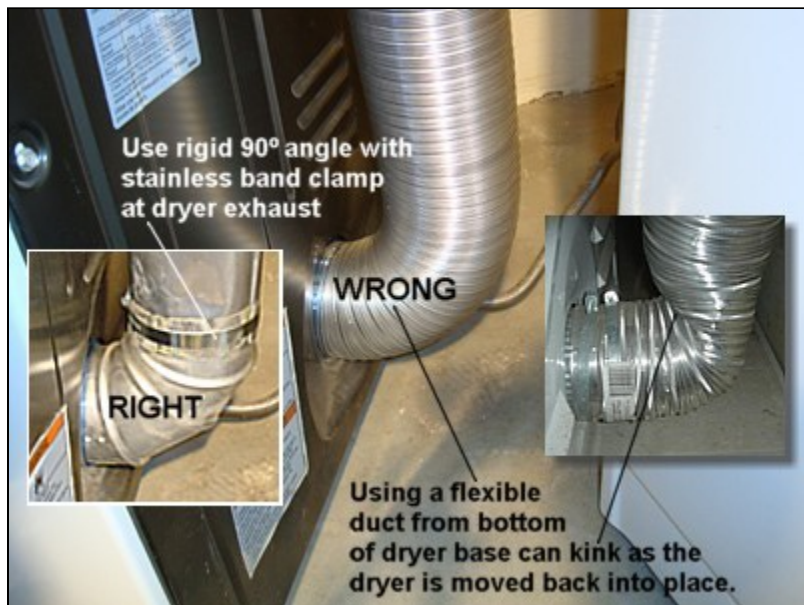

5.7.B Item 3(Picture)

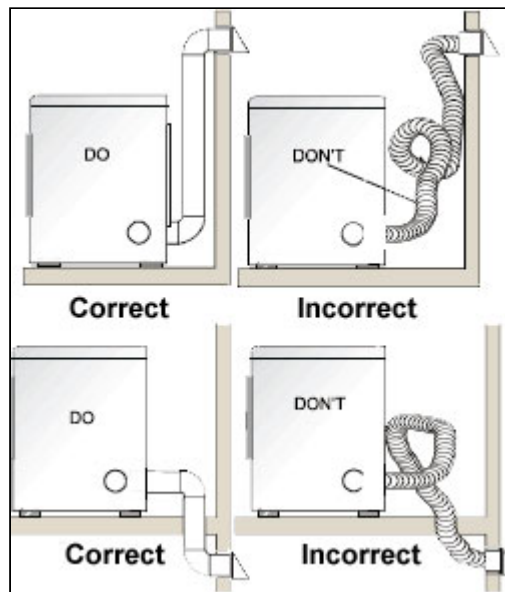

5.7.B Item 4(Picture)

**5.7.B (2)** The dryer vent piping uses a "lint trap kit" and does not vent to the outside in the basement. Recommend checking owners manual to see if this is recommended for this brand appliance. Ideally the dryer should be vented to the outside. Ensure that you clean the trap regularly to prevent a fire from occurring.

Note: Indoor dryer vent buckets are not recommended because of safety reasons, and they may be fire hazards as well.

1. Indoor dryer vent buckets contain water in a bucket, to which the dryer vent is attached. As the dryer is operating, the lint, moisture and heat are vented into the bucket. As the lint accumulates, it can constitute a fire hazard. If the dryer vent is blocked, the dryer operates at higher temperatures. The heat emanated to the vent bucket may be too hot. The lint, which is highly inflammable, can catch fire. The fire can quickly spread to other combustible materials and can lead to disaster.

Another risk factor is the constant presence of moisture, by way of water in the vent bucket. Over time, the moisture from the dryer and the water together can cause problems such as mold and mildew in your home. I would recommend having it corrected by a qualified contractor if possible.



5.7.B Item 5(Picture)

---

The Kitchen area of the home was inspected and reported on with the above information. While the inspector makes every effort to find all areas of concern, some areas can go unnoticed. Please be aware that the inspector has your best interest in mind. Any repair items mentioned in this report should be considered before purchase. It is recommended that qualified contractors be used in your further inspection or repair issues as it relates to the comments in this inspection report.

**6. Rooms**

The home inspector shall observe: Walls, ceiling, and floors; Steps, stairways, balconies, and railings; Counters and a representative number of installed cabinets; and A representative number of doors and windows. The home inspector shall: Operate a representative number of windows and interior doors; The operation of a representative number of installed ceiling fans, lighting fixtures, switches and receptacles; and Report signs of abnormal or harmful water penetration into the building or signs of abnormal or harmful condensation on building components. The home inspector is not required to observe: Paint, wallpaper, and other finish treatments on the interior walls, ceilings, and floors; Carpeting; or Draperies, blinds, or other window treatments. The home inspector is not required to: Move personal items, panels, furniture, or equipment that obstructs access or visibility.



dining room



formal dining room



living room



sitting room

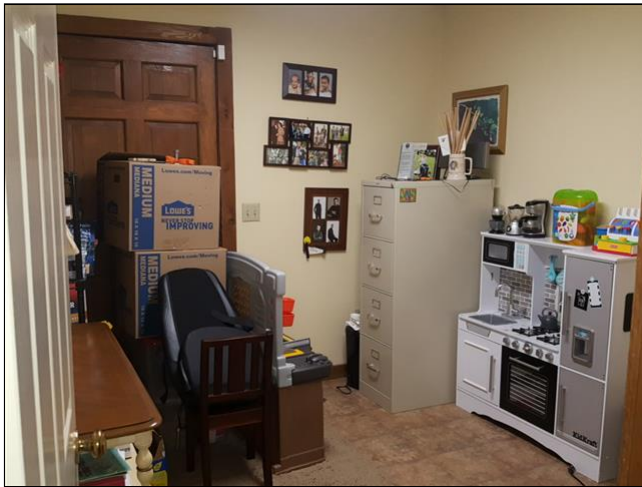

office room



guest bedroom

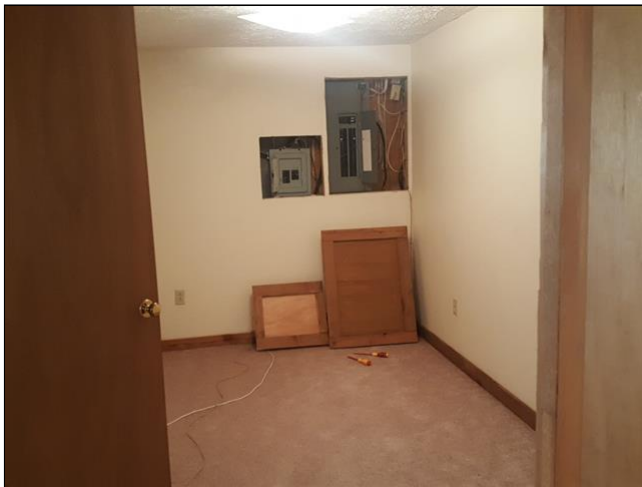

basement storage room



basement family room





basement 2nd bonus room 2



basement kitchen



basement bonus room

## Styles & Materials

### Ceiling Materials:

Drywall  
and  
Wood

### Wall Material:

Drywall  
and  
Wood Paneling

### Floor Covering(s):

Carpet  
Area rug(s)  
Hardwood  
Tile

### Interior Doors:

Hollow core  
Wood

### Window Types:

Wooden Frames  
Double-hung  
Thermal/Insulated

		IN	NI	NP	C	RR
6.0	Ceilings	•				•
6.1	Walls	•				
6.2	Floors	•				
6.3	Steps, Stairways and Railings					•
6.4	Doors (Representative number)	•				

IN= Inspected, NI= Not Inspected, NP= Not Present, C= Conditional, RR= Repair or Replace

IN NI NP C RR

		IN	NI	NP	C	RR
6.5	Windows (Representative number)	•				
6.6	Closets	•				
6.7	Outlets, GFCI, Wall Switches and Fixtures (Lights and Ceiling Fans)					•
6.8	Smoke and Carbon Monoxide Detectors					•
6.9	General Notes	•				

IN= Inspected, NI= Not Inspected, NP= Not Present, C= Conditional, RR= Repair or Replace

**IN NI NP C RR**

**Comments:**

**6.0** (1) The drywall at the ceiling in the guest bathroom above the roof intersection reveals an old water stain indicating a leak did or still exists where indicated by the photo(s). Although there was no leaking or elevated moisture content found at this time, I could not determine how the stain existed. Perhaps ask the owner of the home to explain cause of the stain. Inspections are limited and destructive inspections are excluded. Recommend cleaning the drywall then monitor this area to see if a leak is active and if a leak does exist, recommend further investigation and repair as needed. The repair work will likely involve the removal of the covering in order to determine where the leak is coming from and if it still exists.



6.0 Item 1(Picture)

**6.0** (2) The drywall on the ceiling in the master bedroom reveals a water stain indicating a leak did or still exists. It is positioned directly above the large suction line from the heat pump to the air handler in the attic. Although there was no leaking or elevated moisture content found at this time, future leaks may develop via condensation. Inspections are limited and destructive inspections are excluded. Recommend cleaning the drywall then monitor this area to see if leak is active and if leak does exist recommend further investigation and repair as needed. A qualified HVAC contractor may also be needed to repair leak if it is caused by the large suction line via a missing or deteriorated insulation sleeve.



6.0 Item 2(Picture)

**6.2** (1) The floor in the washer dryer room slopes towards the center of the kitchen in the home as indicated in the photo. This is normal and to be expected in a house of this age due to the joists may be sagging and/or require additional support. There was no evidence of cracks or damaged materials in relation to the floor being in this state. All doors opened and closed without rubbing on the jambs. There was no visible access under this area. Inspections are limited and exhaustive or destructive inspections are excluded. Recommend monitoring the floor and walls in this area periodically to see if cracks appear and if so this area may need further evaluation to determine cause and remedy. A structural engineer will need to be consulted if further sloping and/or settlement cracks greater than 1/8 inch start to occur. This is for your information.



6.2 Item 1(Picture)

6.2 (2) The floor squeaks in the master bedroom sitting room as indicated in the photo(s) (nuisance only). This is for your information and is of no concern from a structural perspective. A qualified carpenter should know how to eliminate or reduce squeaks in the flooring. This will likely involve the removal of the floor covering to repair the squeak in the floor. Repair as desired.

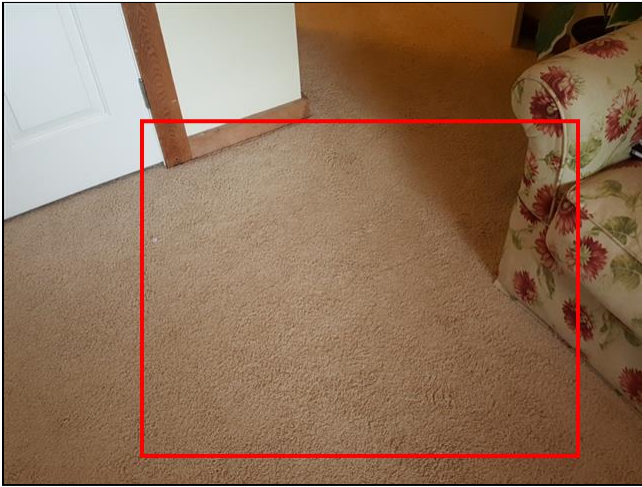

6.2 Item 2(Picture)

### Secure Floor Through Carpeting

Pull carpet fibers away and drive long deck screw through carpet into subfloor. Carpet will close over puncture.

© Tom Feiza Mr. Fix-It Inc.

M039

6.2 Item 3(Picture)

### "Squeeeeeek No More"

Secure floor through carpeting  
(O' Berry Enterprises)

Notch in screw allows screw to break off below carpet after it is set to proper depth by bracket. Bend screw to break.

© Tom Feiza Mr. Fix-It Inc.

M034

6.2 Item 4(Picture)



6.3 (1) The balcony railing is loose/unstable between the dining and living room. This is extremely dangerous and is a safety concern. This could collapse if someone was pushed against or was leaning on the railing. Recommend repair by a qualified contractor before closing.



6.3 Item 1(Picture) dining room

6.3 (2) The stair case rail on the on the left side leading to the upstairs is unstable and not secured properly. This is extremely dangerous and is a safety concern. It may fail under a medium or heavy force or if someone was pushed against or was leaning on the railing. For your safety it should be strengthened and secured. Recommend a qualified contractor repair as needed before closing.

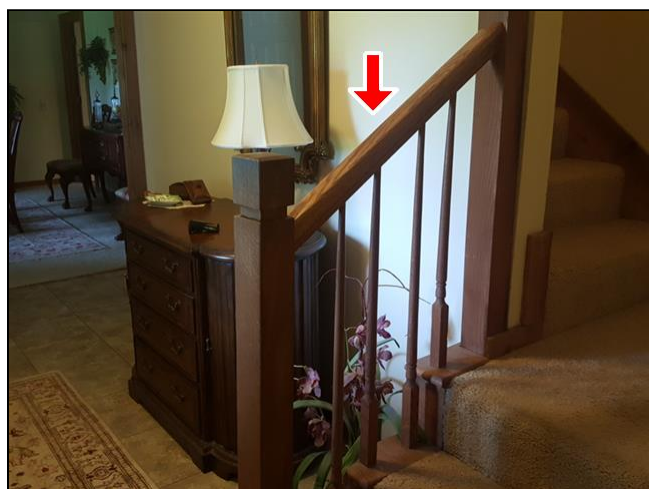

6.3 Item 2(Picture)

6.7 (1) It is not recommended that these adapters be used in the outlets as they can overheat and cause a fire. This is for your safety. Especially in areas like kitchens where numerous appliances can be connected. If additional outlets are required, recommend a qualified electrician install them as needed.



6.7 Item 1(Picture) living room

**Receptacles - Don't Overload**

© Tom Feiza Mr. Fix-It Inc.

Do not use adapters that allow multiple cords into one outlet. You may overload the outlet/circuit. They often have no ground, resulting in poor connections, excessive heat – posing a fire hazard!

E087

6.7 Item 2(Picture)

6.7 (2) The outlet(s) in the basement hallway where indicated in the photo(s) are loose at the wall or in the outlet box. Electrical issues are considered a hazard until repaired. This is a safety issue that needs to be corrected due to an electric shock or fire from loose connections could occur if not repaired. Recommend a qualified licensed electrical contractor correct as needed.



6.7 Item 3(Picture)



6.7 Item 4(Picture)

**6.7 (3)** Recommend sealing the gap between the wall and the outlet in the basement hallway where indicated in the photo(s) to prevent children being electrocuted by placing objects inside the opening. This is a serious safety issue. Recommend a qualified electrician and/or a general contractor repair as needed.



6.7 Item 5(Picture)

6.7 Item 6(Picture)

**6.8 (1)** Testing smoke and CO detectors is not part of a home inspection. We do not want to create a false alarm. If the smoke/CO detector is 10 years old or older, then would recommend replacement. Recommend the smoke detectors be tested in the home upon moving into the home. Note: Here is a link explaining type of alarm to use by the [Dept. of Fire and Emergency Services](#)

**6.8 (2)** There are no smoke detectors installed in the bedrooms. For safety considerations, you should consider installation of a battery or hard wired smoke detector in each bedroom. The smoke detector needs locating at least 4 inches from ceiling/wall junction and no further than 12 inches away. Recommend a licensed electrician install alarms if desired.

Note: Ensure the smoke alarm is a photoelectric type. Here is a link explaining type of alarm to use by the [Dept. of Fire and Emergency Services](#)

**6.8 (3)** There is no visible permanent carbon monoxide detector found in the home. It is recommended that one be installed according to the manufacturer's instructions for safety and to prevent a death from carbon monoxide poisoning due to the water heater located at the upstairs closet.

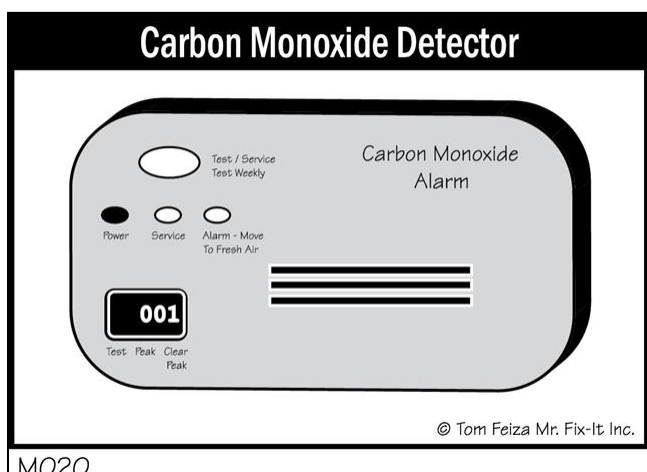

6.8 Item 1(Picture)

**6.9** The house is lived in and the furnishings or items prevented a complete inspection of the interior of the home, receptacles, closets, walls and floors in some areas. These areas should be examined before closing to verify that there is no damage that was hidden by the furnishings.

---

The interior of the home was inspected and reported on with the above information. While the inspector makes every effort to find all areas of concern, some areas can go unnoticed. The inspection did not involve moving furniture and inspecting behind furniture, area rugs or areas obstructed from view. Please be aware that the inspector has your best interest in mind. Any repair items mentioned in this report should be considered before purchase. It is recommended that qualified contractors be used in your further inspection or repair issues as it relates to the comments in this inspection report.



**7. Bathroom and Components**



The home inspector shall observe: Walls, ceiling, and floors; Counters and a representative number of installed cabinets; Interior water supply and distribution system, including: piping materials, supports, and insulation; fixtures and faucets; functional flow; leaks; and cross connections; Interior drain, waste, and vent system, including: traps; drain, waste, and vent piping; piping supports and pipe insulation; leaks; and functional drainage; The home inspector shall operate all plumbing fixtures, except where the flow end of the faucet is connected to an appliance; and Report signs of abnormal or harmful water penetration into the building or signs of abnormal or harmful condensation on building components; The operation of a representative number of installed ceiling fans, lighting fixtures, switches and receptacles, The polarity and grounding of all receptacles within six feet of interior plumbing fixtures. The home inspector is not required to: State the effectiveness of anti-siphon devices; or Observe the system for proper sizing, design, or use of proper materials; Paint, wallpaper, and other finish treatments on the interior walls, ceilings, and floors; Carpeting; or Draperies, blinds, or other window treatments; The home inspector is not required to operate: Any water shut off valves; and Move personal items, panels, furniture, or equipment that obstructs access or visibility.



guest bathroom



basement bathroom

**Styles & Materials**

**Floor Covering(s):**

Tile  
and  
Vinyl

**Wall Material/Coverings:**

Drywall  
and  
Wood Paneling

**Window Types:**

None

**Exhaust Fans:**

Fan with light  
and  
Fan

		IN	NI	NP	C	RR
7.0	Floor	•				
7.1	Counters and Cabinets				•	
7.2	Doors (Representative number)				•	
7.3	Windows	•				
7.4	Plumbing Water Supply, Shutoffs, Faucets, and Fixtures					•
7.5	Plumbing Drain and Vent Systems					•
7.6	Outlets, GFCI (Ground Fault Circuit Interrupters), Wall Switches and Fixtures					•

IN= Inspected, NI= Not Inspected, NP= Not Present, C= Conditional, RR= Repair or Replace

**IN NI NP C RR**

		IN	NI	NP	C	RR
7.7	Bath(s) and/or Shower(s) - walls,enclosure, and doors				•	
7.8	Toilet(s)					•
7.9	Exhaust fan	•				

IN= Inspected, NI= Not Inspected, NP= Not Present, C= Conditional, RR= Repair or Replace

**IN NI NP C RR**

**Comments:**

**7.1** Recommend caulking around the counter top in the guest bathroom to seal the gap/crack. Water may enter which can cause damage to the drywall and cabinets, then result in possible mold forming. Repair using a quality caulk that is resistant to moisture and is expandable. Here is a link on [How to Choose the right Caulk](#)



7.1 Item 1(Picture)

**7.2** The entry door in the basement bathroom where indicated in the photo does close properly, however it rubs at the door jamb when closing where indicated in photos. This is a maintenance issue and is for your information. Sometimes correcting the door opening can require the door trim to be removed then touch up painting or doors will need to be rehung or trimmed down. Recommend a qualified contractor repair as needed.



7.2 Item 1(Picture)

**7.3** There is a double hung window in the Master bathroom. This is for your information.

**7.4 (1)** The drain stopper is missing in the bath tub at the 2nd bathroom. Recommend a qualified licensed plumber install one or a rubber stopper can be used.

**7.4 (2)** The drain control stopper is not connected at the left sink and does not function in the master bathroom. Recommend correcting to allow easy use of the drain lever and to ensure it functions properly. Repair or correct as needed.



7.4 Item 1(Picture)

**7.5 (1)** Flexible ridged pipe is being used for the connection to the drain line under the sink in the master bathroom. The pipe ridges will hold and trap debris which could clog the drain. Plan on cleaning the drain from time to time. Smooth pipe would be better but may be difficult to fit to the existing drain lines. Recommend you seek a qualified licensed plumber to evaluate and correct if needed as this type of work is not to standard workman like practices.



7.5 Item 1(Picture)

**7.5 (2)** Rubber hose pipe is being used for the connection to the drain line under the sink in the basement bathroom. The pipe connections may leak in the future. Recommend you seek a qualified licensed plumber to correct as needed as this type of work is not to standard workman like practices.



7.5 Item 2(Picture)

**7.6 (1)** The outlet(s) in the master and the guest bathroom are GFCI protected however when tripped you need to reset them at the panel box at the appropriate breaker No. 10. This is for your information.

**7.6 (2)** The outlet(s) in the 2nd bathroom are GFCI protected however when tripped you need to reset them at the panel box at the appropriate breaker No. 9. This is for your information.



7.6 (3) The outlet(s) are not GFCI protected in the Master and basement bathrooms where indicated in the photos. Although GFCIs may not have been required at the time that this house was built, these are now required and recommended for safety within any water source as a safety feature when any changes to the outlets are made. GFCI outlet offers protection from shock or electrocution. Recommend a licensed electrician correct as needed prior to moving in.



7.6 Item 1(Picture) master bathroom



7.6 Item 2(Picture) basement bathroom



7.6 Item 3(Picture) basement bathroom

### Safety of GFCI vs. Breaker

20-amp GFCI outlet

Radio shorts to man. GFCI trips power off at .005 amps within 1/40 of a second. NO SHOCK.

20-amp outlet

Radio shorts to man. 20-amp breaker turns power off at 20 amps. SHOCK!

OUCH! Always use GFCI-protected circuits near water. A .005 amp shock should not hurt you. A 20-amp shock will hurt you – it could light you up like 24 100-watt bulbs before the 20-amp breaker trips.

© Tom Feiza Mr. Fix-It Inc.

E125  
7.6 Item 4(Picture)

**7.6** (4) The outlet in the master bathroom where indicated in the photo is loose at the wall or at the outlet box. Electrical issues are considered a hazard until repaired. This is a safety issue that needs to be corrected due to an electric shock or fire from loose connections could occur if not repaired. Recommend a qualified licensed electrical contractor correct as needed.



7.6 Item 5(Picture)

**7.7** (1) Water stains on the wood paneling at the bathtub in the master bathroom was noted. Recommend changing the wall covering to prevent mold and deterioration of the wall covering in the future.



7.7 Item 1(Picture)

7.7 (2) Recommend a quality caulk that is expandable and moisture resistant along the top of the threshold of the bath tub so moisture or water cannot penetrate in the master bathroom. [Choosing the right caulk](#)



7.7 Item 2(Picture)

7.8 The toilet tank base is loose at the floor in the master bathroom. The screws may need tightening to secure the toilet base to the floor to prevent a water leak between the toilet and the drain line connection. If tightening the screws at the base of the toilet does not secure the toilet, repairs may involve re-setting the toilet on a new wax seal and/or repairs to the floor may be required. Recommend a qualified licensed plumber repair or correct as needed.



7.8 Item 1(Picture)

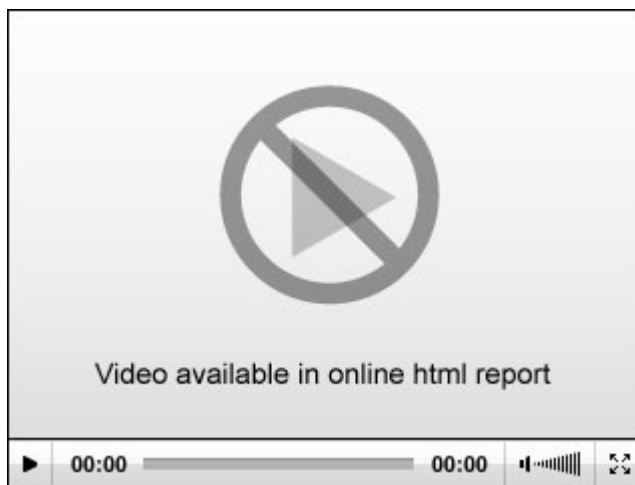

7.8 Item 2(Video)

The bathroom of the home was inspected and reported on with the above information. While the inspector makes every effort to find all areas of concern, some areas can go unnoticed. Please be aware that the inspector has your best interest in mind. Any repair items mentioned in this report should be considered before purchase. It is recommended that qualified contractors be used in your further inspection or repair issues as it relates to the comments in this inspection report.

8. Plumbing System



The home inspector shall observe: Interior water supply and distribution system, including: piping materials, supports, and insulation; fixtures and faucets; functional flow; leaks; and cross connections; Interior drain, waste, and vent system, including: traps; drain, waste, and vent piping; piping supports and pipe insulation; leaks; and functional drainage; Hot water systems including: water heating equipment; normal operating controls; automatic safety controls; and chimneys, flues, and vents; Fuel storage and distribution systems including: interior fuel storage equipment, supply piping, venting, and supports; The home inspector shall describe: Water supply and distribution piping materials; Drain, waste, and vent piping materials; and Location of main water supply shutoff device; Type and capacity of Water heating equipment;. The home inspector shall operate all plumbing fixtures, including their faucets and all exterior faucets attached to the house, except where the flow end of the faucet is connected to an appliance. The home inspector is not required to: State the effectiveness of anti-siphon devices; Determine whether water supply and waste disposal systems are public or private; Operate any valve except water closet flush valves, fixture faucets, and hose faucets; Observe: Water conditioning systems; Fire and lawn sprinkler systems; On-site water supply quantity and quality; On-site waste disposal systems; Foundation irrigation systems; Swimming pools; or Observe the system for proper sizing, design, or use of proper materials; Solar water heating equipment.



water heater/upstairs closet



2nd water heater/basement washer dryer room

Styles & Materials

**Main Water Valve Location:**

Basement  
on the right wall of home

**Water Source:**

Public

**Plumbing Water Supply (into home):**

Black hose

**Plumbing Water Distribution (inside home):**

Copper  
partially visible

**Plumbing Venting Line:**

PVC  
Partially Visible

**Plumbing Waste Line:**

PVC and ABS  
Partially Visible

**Washer Drain Size:**

2" Diameter

**Main Gas Valve Location:**

Undetermined

**Gas Distribution (inside home):**

Both  
Black Iron Pipe  
Copper  
Partially Visible

**Water Heater Manufacturer/Model/Age:**

AMERICAN  
Model# Serial# Year# : #BFG6140S403PH  
#1501100722063 #2015

**2nd Water Heater Manufacturer/Model/Age:**

AGED  
WHIRLPOOL

**Water Heater Power Source/Capacity/Location:**

Propane Gas  
40 Gallon (1-2 people)



Model# Serial# : #ETF40RD045V  
 #0044129510 #2000

Upstairs  
 Hallway closet

**2nd Water Heater Power Source/Capacity/**

**Location:**

- Electric
- 40 Gallon (1-2 people)
- Basement
- Washer/Dryer Room

		IN	NI	NP	C	RR
8.0	Plumbing Drain, Waste Pipes and Vent Systems	•				
8.1	Plumbing Water Supply and Distribution Systems	•				
8.2	Hot Water Systems and Controls					•
8.3	Pipes and Drainage (Hot Water Systems)	•				
8.4	Ventilation and Flue Pipes (Water Heater)					•
8.5	Main Water Supply Pipe and Shut-off Device (Describe location)	•				
8.6	Main Fuel Shut-off (Describe Location)		•			
8.7	Fuels Storage and Distribution Systems (Interior fuel storage, piping, supports, leaks)	•				
8.8	Sump Pump			•		

IN= Inspected, NI= Not Inspected, NP= Not Present, C= Conditional, RR= Repair or Replace

**IN NI NP C RR**

**Comments:**

---

**8.0 (1)** This inspection did not access the septic tank or determine its location. I did not visually locate the septic nor did I inspect the tank and drain lines for size or condition. Changes in water volume use can sometimes have an impact on septic tanks that before were working properly. Most septic contractors recommend that if the septic tank hasn't been pumped and inspected in the last 4-5 years, you should have it pumped and inspected visually during the inspection process to determine its true condition. For a more detailed inspection, recommend you contact a septic pumping company.

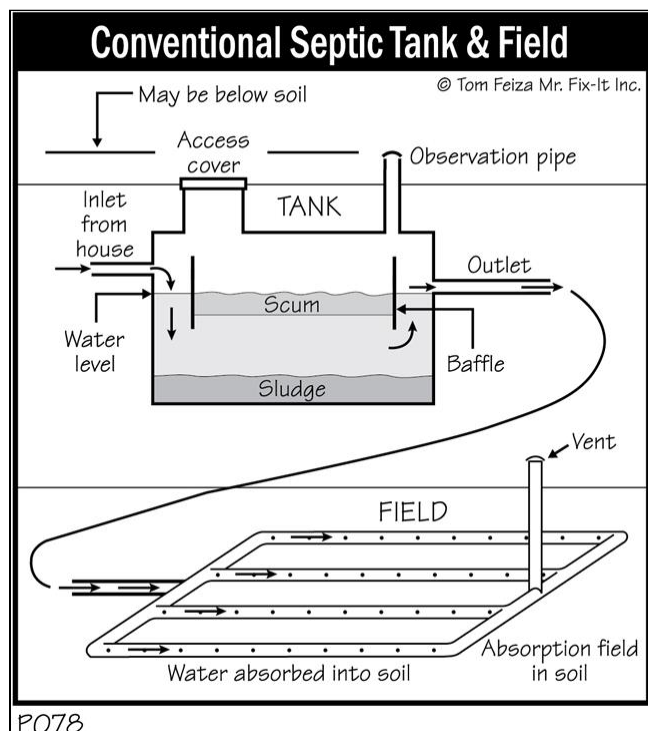

8.0 Item 1(Picture)

**8.0 (2)** Limited inspection of the plumbing waste line(s) in the basement due to access and visibility (finished basement). There may be hidden problems or leaks that could not be seen. If a more comprehensive inspection of the drainage and pipes is desired, recommend you consult a qualified licensed plumber.

**8.1 (1)** This house has a water softener unit under the kitchen sink. I did not inspect any water filtration units. Filters should be changed on a regular basis to prevent pressure loss and to keep the water cleaner. This is for your information. Recommend consulting with owner for operation and maintenance instructions for the unit. I would also recommend contacting the installer or qualified contractor for information on life expectancy and/or condition.



8.1 Item 1(Picture)

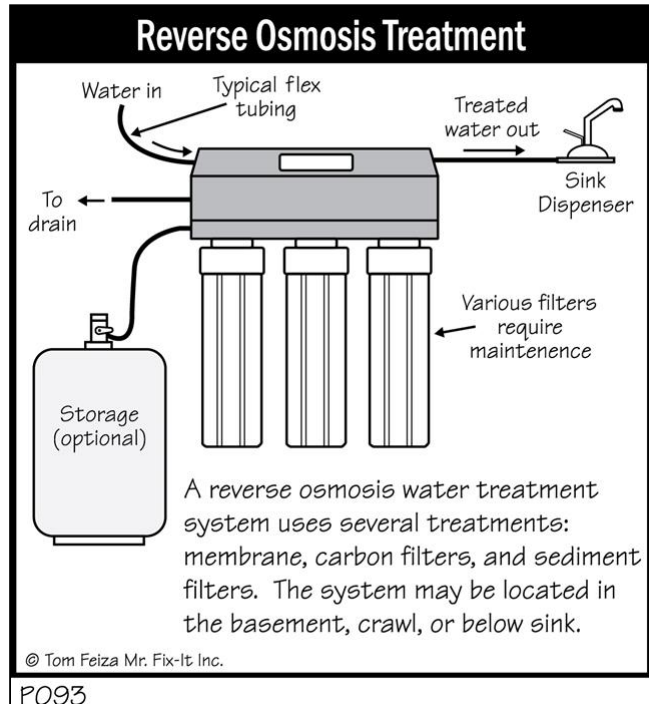

8.1 Item 2(Picture)

**8.1 (2)** Limited inspection of the water supply line(s) in the basement due to access and visibility. There may be hidden problems or leaks that could not be seen. If a more comprehensive inspection of the drainage and pipes is desired, recommend you consult a qualified licensed plumber. There were no visible leaks at the time of the inspection.

**8.1 (3)** The water pressure over-all passed "functional flow" in the home. This is determined by running water at the sinks in the bathrooms, kitchen and shower while the toilet is being flushed. If the shower spray remains, it passes functional flow. This is for your information.

**8.2 (1)** The normal life expectancy of a water heater is between 12-16 years. This is for your information.

**8.2 (2)** Both of your water heaters do not have a "Thermal Expansion tank" installed to prevent a possible leak at the TPR or "pop-off" valve. If the water pressure gets high enough it can damage valves in the plumbing fixtures, joints in the supply pipes and even the water heater. Thermal expansion always occurs in water heaters. Like most substances, water expands as it is heated. There were no visible leaks or drips at the TPR valve during the inspection. If your water heater does begin to drip or leak, then a thermal expansion tank may be needed. This is for your information.

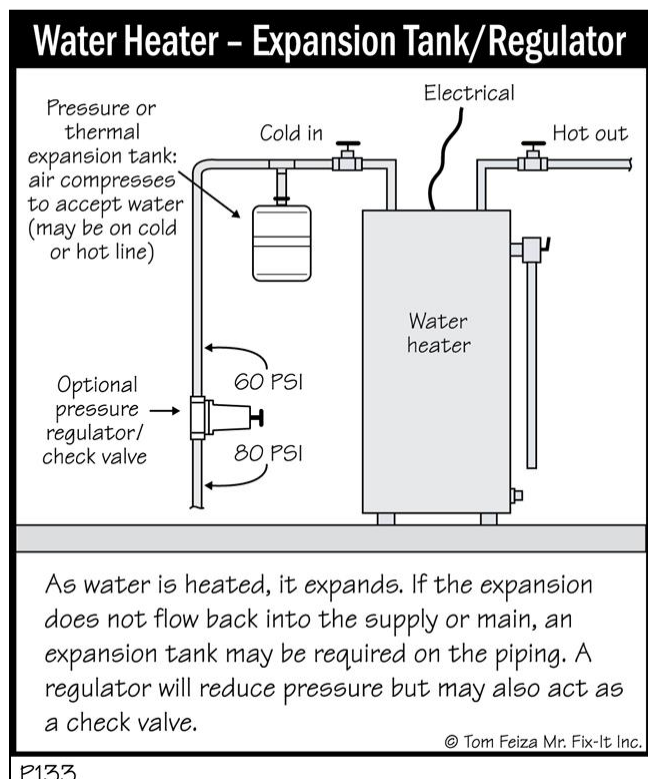

### 8.2 Item 1(Picture)

**8.2 (3)** The water heater in the upstairs closet was installed some time in 2015 or 2016 due to the age of the unit and does not have an "inspection approved label" by the state plumbing inspector that was visible at the time of inspection. This is a red flag. When the water heater was installed, the owner and the installer are both to submit paper work to the local county so the state plumbing inspector comes out and overlooks the installation to ensure it is up to code. Recommend contacting the owner to ask if this was done. If not, recommend contacting your local county to have there inspector check installation or have a qualified plumber verify installation is correct and up to code before closing.



**8.2 (4)** The drain pan installed under the water heater in the upstairs closet is missing a drain line to the exterior. If the water heater leaks it has the potential to cause severe damage if a leak should develop which will result in costly repairs to the floor and ceiling below if a drain line is not connected. As an inexpensive safe-guard a drain pan with a moisture alarm can easily be installed as another option. Recommend a qualified plumber install a drain line at the pan that leads to the exterior of home.



8.2 Item 2(Picture)

**8.2 (5)** Corrosion and a kink at the hot water supply inlet at the top of the water heater was noted in the basement washer dryer room. This usually occurs when two different types of metals are in contact with each other. This area will eventually leak water. Recommend a qualified plumber further investigate and repair as needed. Due to the age of unit, consideration in replacing unit would be wise before a major leak occurs.



8.2 Item 3(Picture)

**8.2 (6)** The water heater in a basement has the potential to cause severe damage if a leak should develop. Consider installing a drain pan under the water heater to prevent damage to the home if a leak develops. This will allow any water leaks to safely drain without damaging the finished materials, floor or furnishings. A qualified plumber could examine and install the drainage pan and drain line, but may need to install a drain line with a trap to the current drainage system. As an inexpensive safe-guard a drain pan with a moisture alarm can easily be installed as another option. Recommend a qualified plumber make the necessary corrections if desired.



8.2 Item 4(Picture)

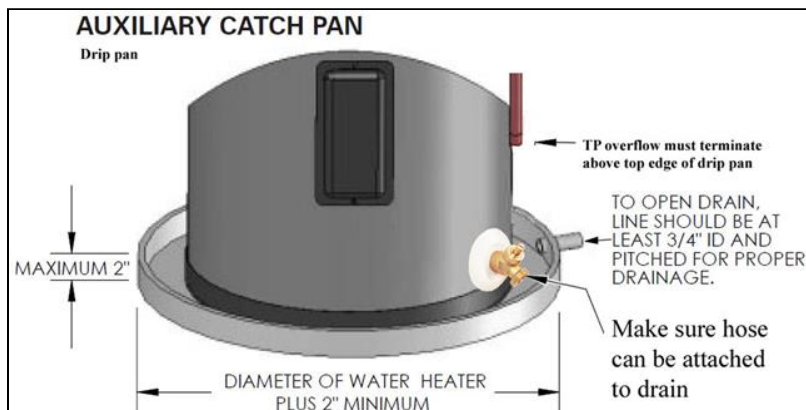

8.2 Item 5(Picture)

**8.2 (7)** The water heater in the basement is at or nearing the end of it's design life. The normal life expectancy of a water heater is between 12-16 years. The water heater in this home is dated 2000. You may wish to consider budgeting for a new water heater in the future. This is for your information.

8.2 (8) There is no strain-relief clamp on the wire where it enters the top of the water heater in the basement. This is a safety issue. A child or person could easily pull the wire out of the heater, touch an energized conductor, and be electrocuted causing possible death. Recommend a qualified licensed electrician repair as needed for safety.



8.2 Item 6(Picture)

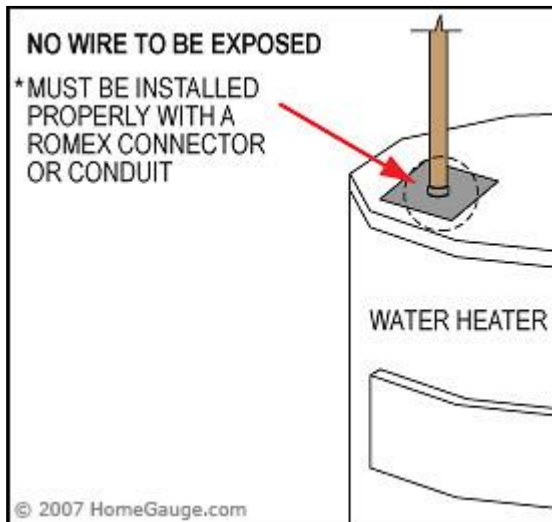

8.2 Item 7(Picture)

8.2 (9) Unprotected electrical wiring leading into the water heater in the basement is susceptible to being damaged and should be covered or protected by a rigid conduit. This is a potential safety issue. This will protect the wire jacket from possible melting if it comes in contact with the hot water line which could energize the unit and cause an electric shock if any water or metal surface is touched. Recommend a qualified electrician install a conduit to make the connection safer and protect the wire from being damaged.



8.2 Item 8(Picture)

8.3 (1) Location of the TPR (temperature pressure relief) drain line to exterior. (see picture)



8.3 Item 1(Picture)

8.3 (2) Could not identify or visibly see where the drainage for the TPR line for the water heater in the upstairs closet is draining to the exterior. Recommend contacting owner for location.

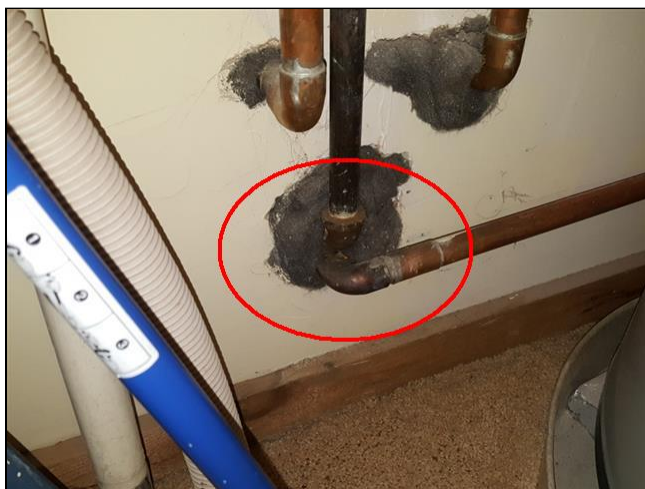

8.3 Item 2(Picture)



**8.4** The water heater is located in the closet upstairs. This is a safety issue and can be hazardous to your health. When a gas appliance is located in a small enclosed room it requires combustion air. If the closet doors are closed, there will be inadequate combustion air for the water heater due to only one vent was found. Inadequate combustion can result in excessive amounts of CO (carbon monoxide) being produced and has been known to cause sickness or death. When a gas appliance is placed in a small confined enclosure, it requires proper ventilation. The easiest remedy is to install two metal 6" pipes to obtain air from the attic or the outside. The two openings located high and low with 144 square inches of free space each, or a louvered door with free space of 288 square inches is required. Recommend a qualified plumber further evaluate and make the necessary corrections for your safety prior to closing.

Note: Vent screens that are used for combustion air for a gas appliance **must not have any damper or closing device**. This is a serious safety issue. Recommend replacing vents that are not adjustable.



8.4 Item 1(Picture)



8.4 Item 2(Picture)

**8.5** (1) The main water shut off is the red knob located in the basement under the living room area. This is for your information.



8.5 Item 1(Picture)

**8.5** (2) Recommend insulating the main water supply line pipe in the basement due to the pipe is located in an unconditioned area. This will ensure that the pipe does not freeze in winter which may cause a serious plumbing leak and prevent costly damage to the home. This is for your information.

**8.6** I could not locate the main shut-off for the gas? Please ask the current owners for the location.

**8.7** Limited inspection of the gas pipes in the home due to access. There may be hidden problems or lack of support of pipes that could not be seen. If a more comprehensive inspection of the gas lines is desired, recommend you consult a qualified licensed plumber.

---

The plumbing in the home was inspected and reported on with the above information. While the inspector makes every effort to find all areas of concern, some areas can go unnoticed. Older homes with galvanized supply lines or cast iron drain lines can be obstructed and barely working during an inspection but then fails under heavy use. If the water is turned off or not used for periods of time (like a vacant home waiting for closing) rust or deposits within the pipes can further clog the piping system. Please be aware that the inspector has your best interest in mind. Any repair items mentioned in this report should be considered before purchase. It is recommended that qualified contractors be used in your further inspection or repair issues as it relates to the comments in this inspection report.

9. Electrical System



The home inspector shall observe: Service entrance conductors; Service equipment, grounding equipment, main over current device, and main and distribution panels; Amperage and voltage ratings of the service; Branch circuit conductors, their over current devices, and the compatibility of their ampacities and voltages. The home inspector shall describe: Service amperage and voltage; Service entry conductor materials; Service type as being overhead or underground; and Location of main and distribution panels. The home inspector shall report any observed aluminum branch circuit wiring, and presence or absence of smoke detectors, and operate their test function, if accessible, except when detectors are part of a central system. The home inspector is not required to: The home inspector is not required to: Perform any procedure that may damage the property or its components or be dangerous to or adversely effect the health of the home inspector or other persons, move personal items, panels, furniture, or equipment that obstructs access or visibility; Insert any tool, probe, or testing device inside the panels; Test or operate any over current device except ground fault circuit interrupters; Dismantle any electrical device or control other than to remove the covers of the main and auxiliary distribution panels; or Observe: Low voltage systems; Security system devices, heat detectors, or carbon monoxide detectors; Telephone, security, cable TV, intercoms, or other ancillary wiring that is not a part of the primary electrical distribution system; or Built-in vacuum equipment.



main panel



main panel



sub panel

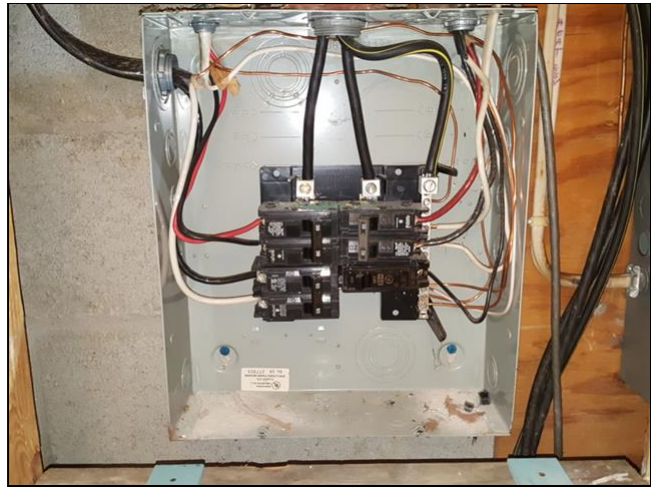

sub panel

Styles & Materials

**Meter Location:**

Right side of home (facing front)  
Extra Info : Under the porch

**Electrical Main Disconnect:**

Panel Box

**Electrical Service Conductors Entry:**

Copper  
240 volts  
2/0 200 Amps

Electric Panel Manufacturer/Type:

Panel capacity:

Branch wire 15 and 20 AMP:

SQUARE D  
Circuit breakers

200 AMP

Copper

		IN	NI	NP	C	RR
9.0	Service Entrance Conductors and Meterbase	•				
9.1	Location of Main and Distribution Panels	•				
9.2	Main and Distribution Panels, Main Overcurrent Device, and Service.					•
9.3	Branch Circuit Conductors, Overcurrent Devices and Compatability of their Amperage and Voltage					•
9.4	Polarity and Grounding of Receptacles within 6 feet of interior plumbing fixtures, and all receptacles in garage, carport and exterior walls	•				
9.5	Breaker Operation of GFCI (Ground Fault Circuit Interrupters) AFCI (Arc Fault Circuit Interrupters)	•				
9.6	General Comments	•				

IN= Inspected, NI= Not Inspected, NP= Not Present, C= Conditional, RR= Repair or Replace

IN NI NP C RR

**Comments:**

**9.1** The main panel box is located in the basement storage room.

**9.2 (1)** The panel box is missing an electricians approval sticker. Many older homes have had modifications made to the electrical for convenience or to add appliances, lights, or receptacles. These modifications may have used the existing circuits in the house instead of installing additional breakers and wiring as required by the code in effect at that time. Be aware that this may result in overloaded breakers or wiring cables. Unfortunately these conditions cannot be discovered during a general home inspection and may only be discovered when several of the components are used at the same time resulting in an overloaded circuit and tripped breaker. Due to the findings with some issues in the electrical main panel, **strongly** recommend a qualified electrician further inspect panel box and wiring and perform a complete electrical system evaluation for improper wiring per the edition of the code which was in effect at the time, correct problems they may find that were not visible at time of inspection, and make the necessary repairs as needed to ensure safety of the occupants and condition within the home prior to closing.



9.2 (2) There are screws missing from the cover for both the electric panels where indicated in photos. This is a safety issue. The missing cover screws should be installed to prevent easy entry and to prevent moisture from entering the panel box. Recommend an licensed electrician correct as needed for your safety.



9.2 Item 1(Picture) main panel

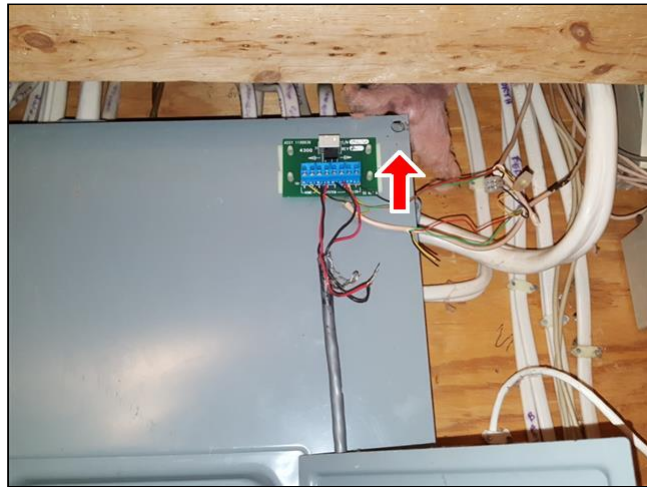

9.2 Item 2(Picture) main panel

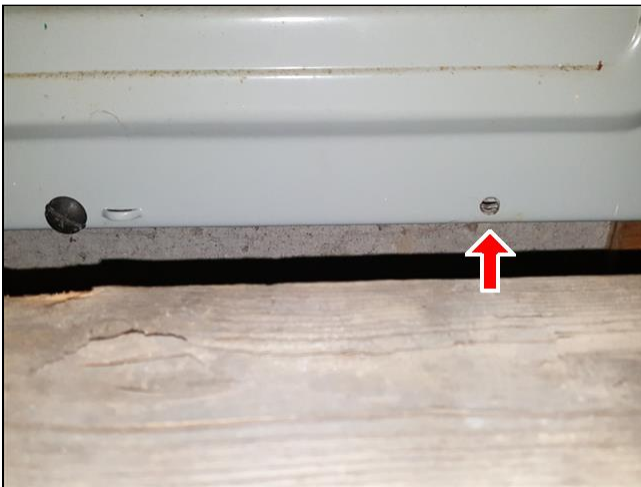

9.2 Item 3(Picture) sub panel

9.2 (3) Cable clamps (sometimes referred to as bushings or grommets) are required where wiring passes into the electrical main panel box. Cable clamps serve to protect the wiring from the metal edges of the panel box to prevent a short from occurring or from the panel box becoming energized which can result in a death via electric shock. This is a safety issue. Recommend a qualified licensed electrician repair as needed.

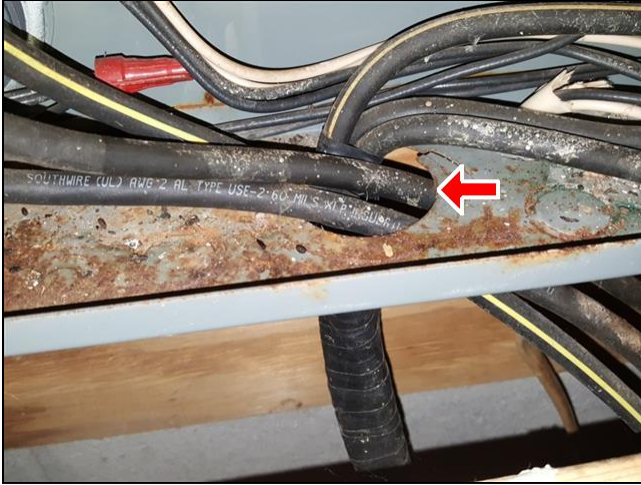

9.2 Item 4(Picture)

9.2 (4) The wiring in the main panel box is near or on top of the panel under where the cover is attached on both sides. This is a serious safety issue. If the panel cover were to be secured with screws on this side it could crush wires which may cause the box to energize resulting in a death via electrocution if the panel box is touched. Recommend a qualified licensed electrician correct for safety as needed.

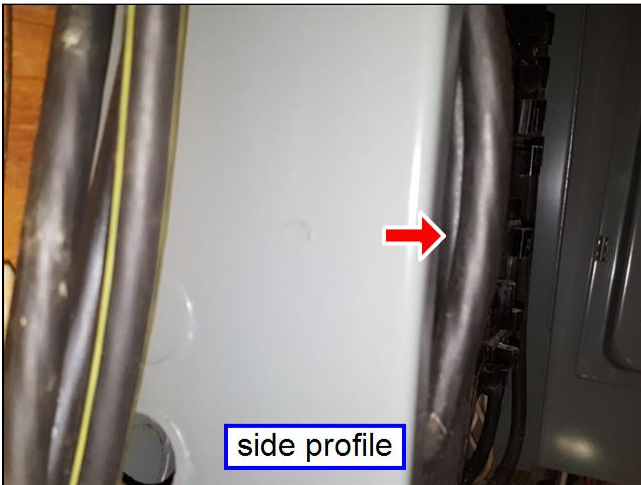

9.2 Item 5(Picture)

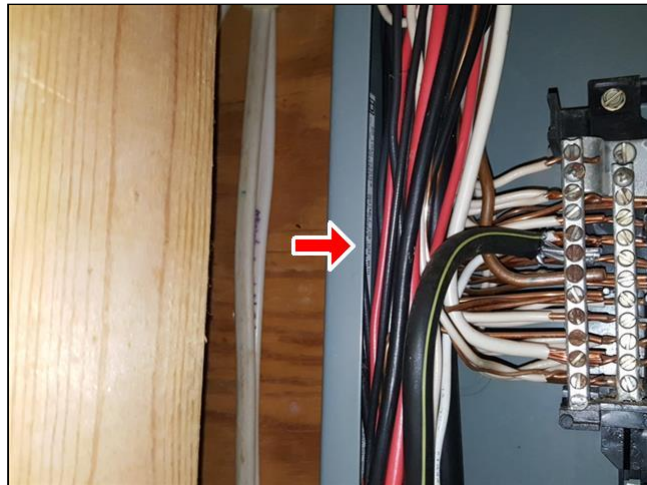

9.2 Item 6(Picture)

9.2 (5) No wires should be attached to the panel cover. This makes it difficult to have it removed for inspection and repairs when needed. Recommend an electrician correct as needed.

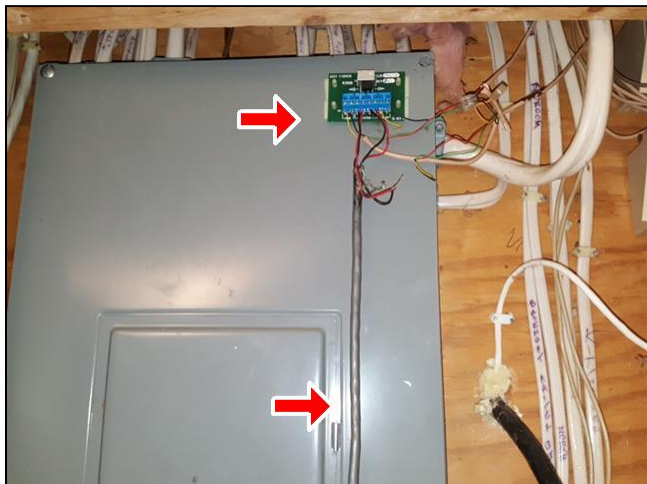

9.2 Item 7(Picture)

9.2 (6) Some of the circuit breakers are not labelled at the sub panel cover. This is a safety issue. Could not check if breakers may be overloaded with appliances in the home. The electrical panel should be indexed, identifying each circuit breaker. This will allow for quick de-energizing of a circuit under emergency situations. Recommend the panel be fully labelled to facilitate turning off breakers to circuits. A licensed electrician is recommended to correct as needed.

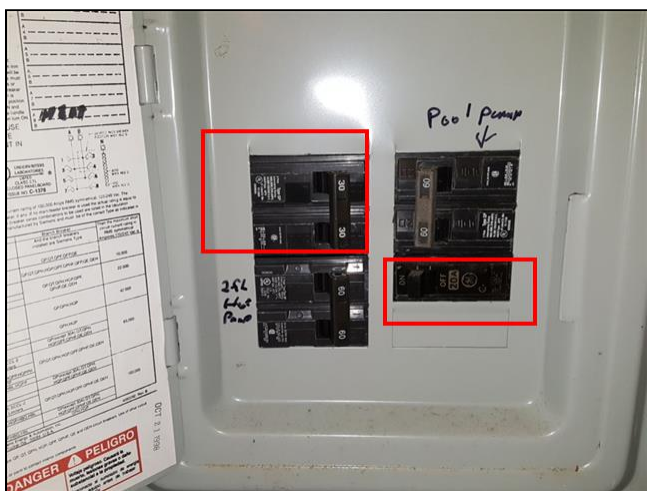

9.2 Item 8(Picture)

**9.3 (1)** Evidence of scorched wires was noted on the bus bar in the main panel. This indicates that a short is happening and a fire could develop if not repaired or corrected. Strongly recommend a qualified licensed electrician further investigate all wiring in the panel box and correct problems found as needed for your safety.

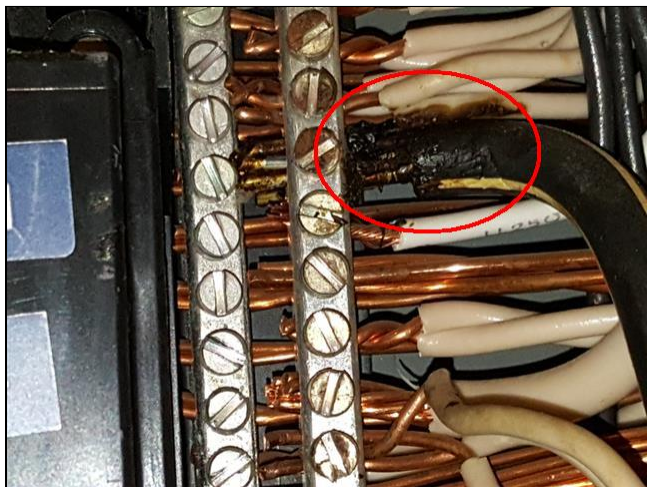

9.3 Item 1(Picture)

**9.3 (2)** The breaker for the Heat Pump on the ground level is oversized in the panel box. Currently it has a 40 amp breaker installed, whereas the data plate on the Heat Pump specifies maximum breaker of 35 amps. The concern with an oversized breaker is typically causing possible damage to the equipment, and if the unit pulls more than 35 amps it could cause the insulation on the wires to start to melt. This will void warranty on the unit. Recommend a qualified HVAC contractor and/or electrician further evaluate to determine if correction is needed.



9.3 (3) Multiple tap wiring (more than one hot wire attached to the same breaker) was found in the main panel. This panel and breakers are NOT MADE or DESIGNED to provide adequate holding power for multiple wires on a single breaker. A separate breaker should serve each circuit. This is a very hazardous and is a safety issue. May cause a fire or short. Recommend a qualified electrician further evaluate the panel box for further issues and repair and correct as needed.

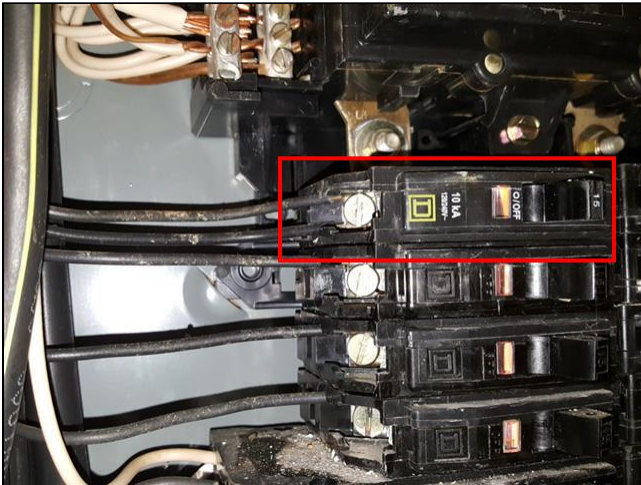

9.3 Item 2(Picture)

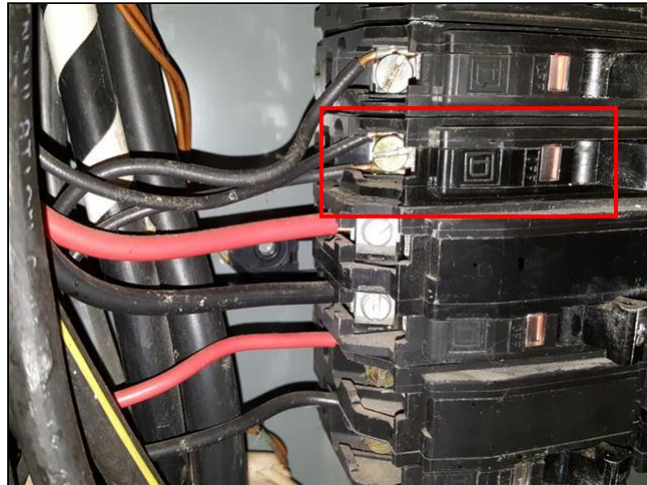

9.3 Item 3(Picture)

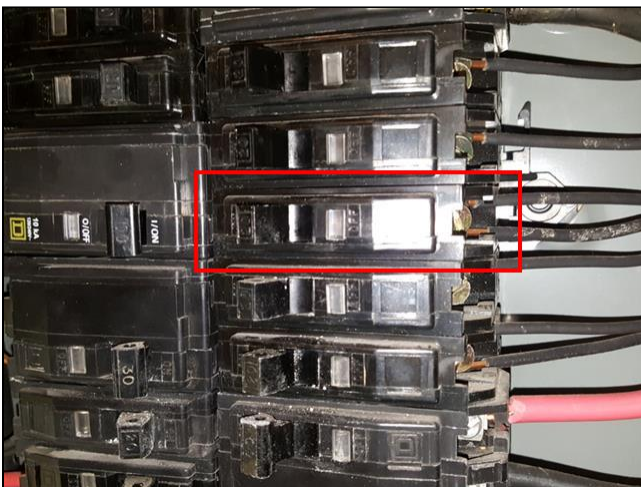

9.3 Item 4(Picture)

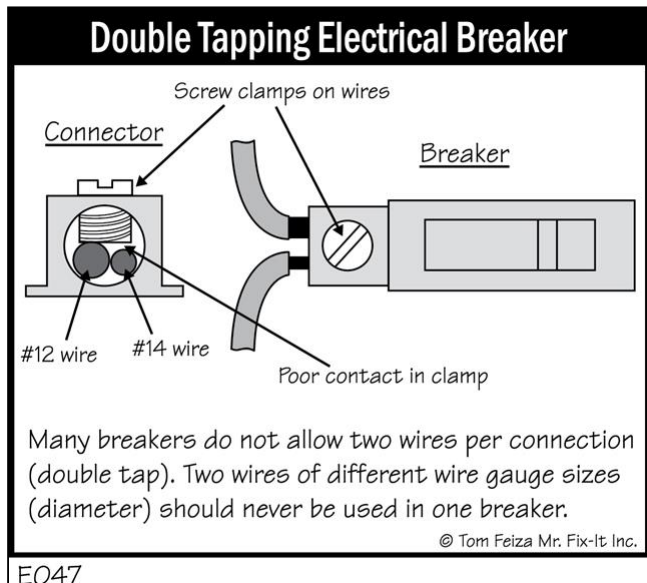

9.3 Item 5(Picture)

9.3 (4) The white wire(s) that are connected to the circuit breaker(s) in the main panel should be marked black to indicate that they are live (hot wires) and are being used for the flow of electricity to travel. Recommend an electrician correct due to safety.

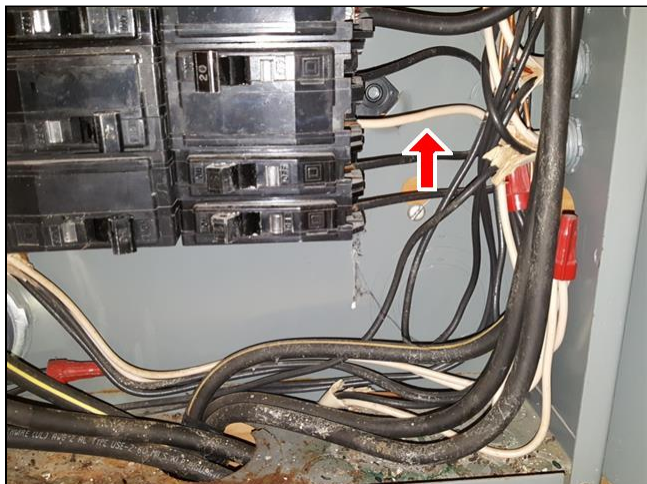

9.3 Item 6(Picture)

9.3 (5) Some of the breakers are not manufactured by the maker of the sub panel. Most mismatched breakers are normally not allowed because the connections may be loose or tight which can result in an electrical fire or short. This is a potential safety hazard. Recommend a qualified electrician verify that these breakers are compatible with this panel prior to closing.



9.3 Item 7(Picture)

**9.3** (6) Wires that are not in use or connected to a breaker in the panel box should have a twist cap to protect the wire from possibly being energized if it comes in contact with current. If not corrected this could lead to a possible short creating a fire or it may energize the panel box creating an electrical shock when the box is touched. This is a serious safety issue. Recommend a qualified electrician repair as needed and further inspect panel to determine any other additional issues that could not be found within the panel box for your safety.

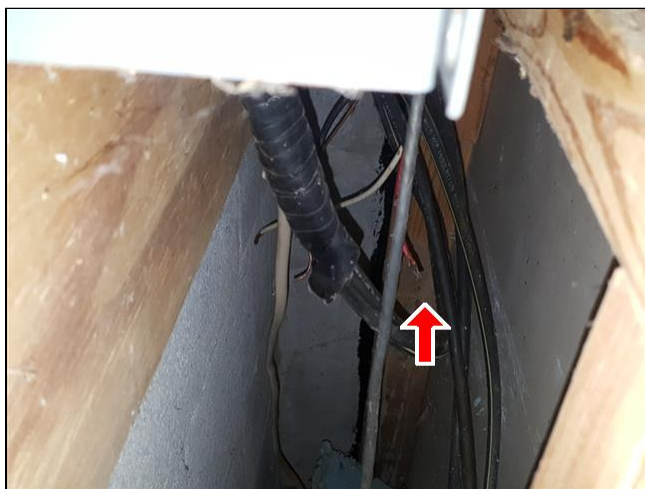

9.3 Item 8(Picture)

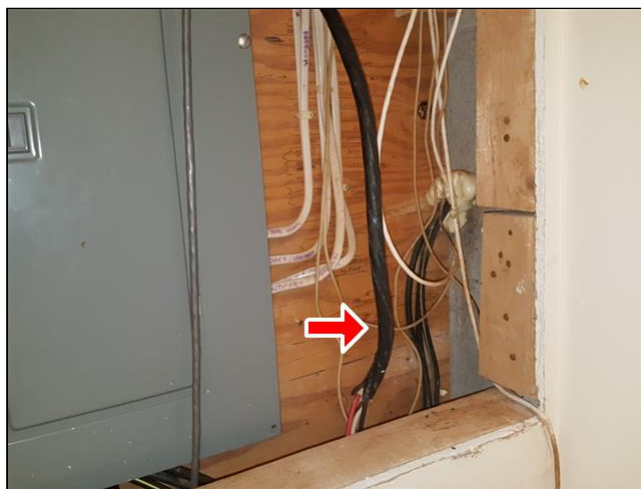

9.3 Item 9(Picture)

**9.6** Due to the findings with some issues in the electrical panel, no electricians approval sticker when the house was built and updated, recommend a qualified electrician further inspect the panel box and wiring and perform a complete electrical system evaluation for improper wiring per the edition of the code which was in effect at the time of the modifications and make the necessary repairs as needed to ensure safety of the occupants and condition within the home.

---

The electrical system of the home was inspected and reported on with the above information. While the inspector makes every effort to find all areas of concern, some areas can go unnoticed. Outlets were not removed and the inspection was only visual. Any outlet not accessible (behind the refrigerator for example) was not inspected or accessible. Please be aware that the inspector has your best interest in mind. Any repair items mentioned in this report should be considered before purchase. It is recommended that qualified contractors be used in your further inspection or repair issues as it relates to the comments in this inspection report.



**10(A) . Heating / Central Air Conditioning Unit 1 Lower Level**



The home inspector shall observe permanently installed heating and cooling systems including: Cooling Equipment including; condenser and evaporative units; coils; refrigeration lines, and condensation lines; Heating equipment; Normal operating controls; Automatic safety controls; Chimneys, flues, and vents, where readily visible; Solid fuel heating devices; Heat distribution systems including fans, pumps, ducts and piping, with supports, insulation, air filters, registers, radiators, fan coil units, convectors; and the presence of an installed heat source in each room. The home inspector shall describe: Energy source; and Heating equipment and distribution type. The home inspector shall operate the systems using normal operating controls. The home inspector shall open readily openable access panels provided by the manufacturer or installer for routine homeowner maintenance. The home inspector is not required to: Operate heating/cooling systems when weather conditions or other circumstances may cause equipment damage; Operate automatic safety controls; Check the electrical current drawn by the unit; Inspect gas fired refrigeration systems, evaporative coolers, or wall or window mounted air conditioning units; Ignite or extinguish solid fuel fires; or Observe: The interior of flues; Fireplace insert flue connections; Humidifiers; or The uniformity or adequacy of heat/cool supply to the various rooms.



heat pump/right side of home



gas furnace/basement

**Styles & Materials**

**Central Cooling Air Brand/Model/Year:**  
 TEMPSTAR  
 Serial # Model# Year# : #E102630051  
 #TXH536GKA100 #2010

**Cooling Equipment Source/  
 Capacity/Type/Location:**  
 Electric  
 3 tonne  
 High Efficiency  
 Heat Pump Forced Air (also  
 provides warm air)  
 right side of home

**Number of Cooling Units  
 (excluding window units):**  
 Two

**Heat System Brand/Model/Year:**  
 TEMPSTAR  
 Serial # Model# Year# : #A103662746  
 #T9MVX100L20A1 #2010

**Heating Source/Capacity/Type/  
 Location:**  
 Gas  
 Propane  
 100000 BTU/HR  
 High Efficiency Power vented  
 Basement

**Number of Heat Systems  
 (excluding wood):**  
 Two

**Filter Type/Size/Location:**  
 Disposable  
 (Two filters)  
 16x25

**Ductwork:**  
 Insulated  
 partially visible

**Fireplaces/Location:**  
 Four  
 Living Room  
 Basement Family Room



Basement  
at the gas furnace

Master bedroom  
Sitting room

**Types of Fireplaces:**

Wood Burning  
or  
Propane gas logs vented  
and  
Propane gas logs non-vented

		IN	NI	NP	C	RR
10.0.A	Heating / Cooling Equipment	•				
10.1.A	Filter Location/Condition				•	
10.2.A	Automatic Safety Controls	•				
10.3.A	Electrical (heating and cooling systems)	•				
10.4.A	Distribution Systems (Pipes and Pumps)	•				
10.5.A	Ducts and Registers	•				
10.6.A	Presence of installed heat and cooling source in each room	•				
10.7.A	Normal Operating Controls (Thermostat)	•				
10.8.A	Temp Differentials (Cooling)	•				
10.9.A	Ventilation (heating systems)	•				
10.10.A	Solid Fuel heating Devices (Fireplaces, Woodstove, Damper)			•		
10.11.A	Gas/LP Firelogs and Fireplaces					•
10.12.A	Chimneys, Flues and Damper (for fireplaces)	•				
10.13.A	General Notes	•				

IN= Inspected, NI= Not Inspected, NP= Not Present, C= Conditional, RR= Repair or Replace

IN NI NP C RR

**Comments:**

**10.0.A (1)** Due to the season, the heat pump was tested in the cooling and emergency heat modes only. The heating mode uses the same components as the cooling mode but in the reverse cycle. To avoid possible damage to the unit due to outside temperature is above 60 degrees, the unit was not tested in the heat mode.

**10.0.A** (2) The heat pump should be raised of the ground for better efficiency and proper drainage. Blocked fins via snow coverage can harm the unit and increase energy costs. Recommend a qualified HVAC contractor correct if desired. Ensure when a new unit is installed that this is done on new installation.



10.0.A Item 1(Picture)

**10.0.A** (3) The gas furnace was not tested for operation due to the outside temperature not being cold enough for the furnace to engage. The gas furnace is only used as a back-up and for efficiency. Refer to general notes for full explanation on how system works with two heating types.

**10.1.A** (1) Filter location (see photo). The arrow on the filter should always point towards the blower.



10.1.A Item 1(Picture)



10.1.A Item 2(Picture)

**10.1.A** (2) The door to access the filter next to the Gas Furnace is missing in the basement. This can allow dirt and debris to bypass the filter. The filter ensures clean air is distributed within the home and also protects the equipment from small debris entering which can lead to problems with the unit and duct work. Recommend replacement/correcting as needed by a qualified HVAC contractor.

**10.4.A** (1) Location of the condensate drain line to exterior. (see photo)



10.4.A Item 1(Picture)

**10.4.A** (2) The condensate pump was tested and was working at time of inspection.



10.4.A Item 2(Picture)

**10.5.A** (1) Ensure the return air ducts in the home are kept clear and not blocked with furniture. Return air ducts must have a clearance of at least 2 feet so they are doing their job in returning air back into the system. Blocking an air vent with a sofa or furniture can reduce the air flow by 30 percent or more. This can have a significant impact on the way your system is operating. Blocked ducts reduces the efficiency of the heating and cooling systems in the home. You will stop the system from working efficiently. This is for your information.

**10.5.A** (2) Never fully close any register in a particular room(s). This can place stress on the blower fan of your unit and may shorten it's life span. It is okay to partially close registers so long as there is an airflow being pushed through. This is for your information.

Here is an article explaining [why supply and return ducts must be open and clear](#).

**10.6.A** It is difficult to eliminate temperature differences between the basement and the upper level in the home. In winter the warm air tends to rise causing the upper level to be warmer. In summer the cool air flows down causing the basement to be cooler. This condition can be somewhat adjusted by fully opening or partially closing the internal louvers inside the ducts in the basement or upper level. Note: never completely close off supply registers. If adjustment of the registers does not fulfill your comfort needs recommend you contact a qualified HVAC contractor. It is possible to have a HVAC contractor create a "zoned" system using an additional thermostat in the basement. This is for your information.

**10.8.A** The ambient air test was performed by using thermometers at the registers closest to the blower to determine if the difference in temperatures of the supply and return air are between 14 degrees and 22 degrees which indicates that the unit is cooling as intended. The supply air temperature on your system read 50 degrees, and the return air temperature was 70 degrees. This indicates the range in temperature drop is normal.



10.8.A Item 1(Picture)

**10.9.A** Could not locate the exhaust vent port for the gas furnace in the basement to the exterior. Recommend asking owner for location or you may need to consult HVAC contractor. Ensure they are not blocked. Failure to provide proper venting may result in a fire, an explosion, or generation of deadly carbon monoxide gas within the home. This is for your information.

**10.10.A** (1) The fireplace in the living room, sitting room and the Master Bedroom is currently being used for vented fire logs (propane). However the fireplace can also accommodate wood burning. Before converting fireplace back to wood, I strongly recommend a qualified fireplace contractor further inspect the fireplace and chimney before lighting any fires. This is for your information.



10.10.A (2) The fireplace in the basement is not suited for wood burning. This is for your information.



10.10.A Item 1(Picture)

**10.11.A (1)** The fireplace in the living room, sitting room, and master bedroom is equipped with a gas log insert with the pilot light turned off. The inspector is **NOT** required to light pilot lights and operate these fixtures. Reason why we do not light pilot lights is for safety. As such we suggest that the pilot be lit and the fireplace operation be verified with the current owner during the final walk-through to insure continued good operating conditions. If the owner is unsure or if the gas fireplace has not been used for some time, we strongly recommend a qualified fireplace contractor further evaluate and inspect to ensure safety and operation of the gas fireplace prior to moving in.

Note: when the gas fireplace is being operated you **MUST** have the damper fully opened in order to prevent carbon monoxide entering the home which is a poisonous gas that can lead to a death.



10.11.A Item 1(Picture) living room



10.11.A Item 2(Picture) sitting room



10.11.A Item 3(Picture) master bedroom

**10.11.A (2)** Could not locate the gas shut off for all the fireplaces in the home. Recommend consulting with the owner for location. This must be known for safety in the event the gas needs to be turned off if there is a leak. Turning the gas off at the meter is **NOT** an alternative.

**10.11.A** (3) The non vented gas fireplace at the basement family room was not inspected for operation. There was no pilot light lit. The inspector is **NOT** required to light pilot lights and operate these fixtures. Reason why we do not light pilot lights is for safety. As such we suggest that the pilot be lit and the fireplace operation be verified with the current owner during the final walk-through to insure continued good operating conditions. If owner is unsure or gas fireplace has not been used for some time, we strongly recommend a qualified fireplace contractor further evaluate and inspect to ensure safety and operation of the gas fireplace prior to moving in.



10.11.A Item 4(Picture)

**10.12.A** Our inspection of the chimney is limited to the readily visible portions only. The inner reaches of the flue is relatively inaccessible. Our restricted view from the top or bottom is not adequate to discover possible deficiencies or damage, even with a strong light. For safe and efficient operation we recommend annual inspections by a qualified fireplace professional. A qualified fireplace professional will clean the interior if necessary, use specialized tools, testing procedures, mirrors and video cameras as needed to evaluate the fireplace system. If the chimney/flue has not been inspected or cleaned by a qualified fireplace professional within the past year we recommend this be done prior to use.

Please Note: Ensure the professional is a member of the CSIA, Chimney Safety Institute of America.



10.12.A Item 1(Picture) living room



10.12.A Item 2(Picture) master bedroom

**10.13.A (1)** During inspection it was noted that the home was not being cooled as intended. Upon arrival the temperature within the home was 76degrees. The thermostat was set to 72 degrees and took nearly 4 hours to reach the desired setting within the home before the unit turned off. This indicates that the unit is not running efficiently. This could be caused by a number of conditions, some could be costly. This condition can increase cooling and heating costs and add wear and tear on the HVAC unit within the home. Recommend a qualified licensed HVAC contractor further inspect and evaluate heat pump for proper operation before closing.

**10.13.A (2)** This home has a 2 heat pumps and 1 gas furnaces for heating the home. A dual-fuel furnace system takes on the problem with a hybrid approach that combines a heat pump and a backup gas-fired heater. As long as outdoor temperatures remain above the balance point, the heat pump handles the job of keeping the house warm with typical heat pump energy-efficiency and low operating costs. Meanwhile, an outside sensor and thermostat continuously monitor the outdoor air temperature. If it drops to the balance point, the thermostat controller automatically shuts down the heat pump and actuates the backup furnace. When outdoor temps again rise above the balance point, the gas-fired unit shuts down and the heat pump kicks in again. Because natural gas is significantly less costly than electricity, the household heating budget takes a considerably smaller hit when the system utilizes the gas backup furnace. This is for your information.

**10.13.A (3)** Check with the owner to verify when the HVAC System was serviced last. If it hasn't been serviced in the past 12 months, would **strongly** recommend having the unit serviced to ensure efficient and safe operation of the unit, especially due to the unit was not tested in the heating mode.

---

The heating and cooling system of this home was inspected and reported on with the above information. While the inspector makes every effort to find all areas of concern, some areas can go unnoticed. The inspection is not meant to be technically exhaustive. The inspection does not involve removal and inspection behind service door or dismantling that would otherwise reveal something only a licensed heat contractor would discover. Please be aware that the inspector has your best interest in mind. Any repair items mentioned in this report should be considered before purchase. It is recommended that qualified contractors be used in your further inspection or repair issues as it relates to the comments in this inspection report.



**10(B) . Heating / Central Air Conditioning Unit 2 Upper Level**



The home inspector shall observe permanently installed heating and cooling systems including: Cooling Equipment including; condenser and evaporative units; coils; refrigeration lines, and condensation lines; Heating equipment; Normal operating controls; Automatic safety controls; Chimneys, flues, and vents, where readily visible; Solid fuel heating devices; Heat distribution systems including fans, pumps, ducts and piping, with supports, insulation, air filters, registers, radiators, fan coil units, convectors; and the presence of an installed heat source in each room. The home inspector shall describe: Energy source; and Heating equipment and distribution type. The home inspector shall operate the systems using normal operating controls. The home inspector shall open readily openable access panels provided by the manufacturer or installer for routine homeowner maintenance. The home inspector is not required to: Operate heating/cooling systems when weather conditions or other circumstances may cause equipment damage; Operate automatic safety controls; Check the electrical current drawn by the unit; Inspect gas fired refrigeration systems, evaporative coolers, or wall or window mounted air conditioning units; Ignite or extinguish solid fuel fires; or Observe: The interior of flues; Fireplace insert flue connections; Humidifiers; or The uniformity or adequacy of heat/cool supply to the various rooms.



heat pump/right side of home



air handler/attic

**Styles & Materials**

**Central Cooling Air Brand/Model/Year:**

TEMPSTAR  
Serial # Model# Year# : #E10120237  
#TXH530GKA100 #2010

**Cooling Equipment Source/Capacity/Type/Location:**

Electric  
2.5 tonne  
High Efficiency  
Heat Pump Forced Air (also provides warm air)  
right side of home

**Heat System Brand/Model/Year:**

TEMPSTAR  
Serial # Model# Year# :  
##A102569247 #FXM4X3000A #2010

**Heating Source/Capacity/Type/Location:**

Electric  
2.5 tonne  
Air Handler  
Attic  
Master bedroom closet area

**Filter Type/Size/Location:**

Disposable  
(Two filters)  
14x20  
Return air grille located at  
Upstairs hallway ceiling  
Master Bedroom

**Ductwork:**  
Insulated

		IN	NI	NP	C	RR
10.0.B	Heating / Cooling Equipment					•
10.1.B	Filter Location/Condition	•				
10.2.B	Electrical (heating and cooling systems)					•

IN= Inspected, NI= Not Inspected, NP= Not Present, C= Conditional, RR= Repair or Replace

**IN NI NP C RR**

		IN	NI	NP	C	RR
10.3.B	Distribution Systems (Pipes and Pumps)	•				
10.4.B	Ducts and Registers	•				
10.5.B	Presence of installed heat and cooling source in each room	•				
10.6.B	Normal Operating Controls (Thermostat)	•				
10.7.B	Temp Differentials (Cooling)	•				
10.8.B	General Notes	•				

IN= Inspected, NI= Not Inspected, NP= Not Present, C= Conditional, RR= Repair or Replace

**IN NI NP C RR**

**Comments:**

**10.0.B (1)** Due to the season, the heat pump was tested in the cooling and emergency heat modes only. The heating mode uses the same components as the cooling mode but in the reverse cycle. To avoid possible damage to the unit due to outside temperature is above 60 degrees, the unit was not tested in the heat mode.

**10.0.B (2)** The Air Handler in the attic has a condensate drip tray with an aqua guard shut off switch installed. In the event that condensate malfunctions or water overflows into the tray the float switch will sense there is excess water in the tray and will shut down the system. This may be inconvenient in hot weather, but the installer or owner have chosen to protect the building against a potentially costly mold or water damage to the attic. This is for your information.

Please note: If your HVAC system seems okay but won't turn on, this switch could be one of the items to check. Recommend checking the tray each quarter for water as it has no where to drain away.



10.0.B Item 1(Picture)

**10.0.B** (3) Water was found in the condensate drain pan under the air handler in the attic. This water may be leaking from the evaporative coil or maybe caused by condensation from the large suction line leading into the unit. **Strongly** recommend a qualified HVAC contractor further investigate for cause and make any needed repairs that may be necessary prior to closing. Also recommend the Aqua guard condensate shut off switch be checked to see if it is working as the unit remained on during the inspection.

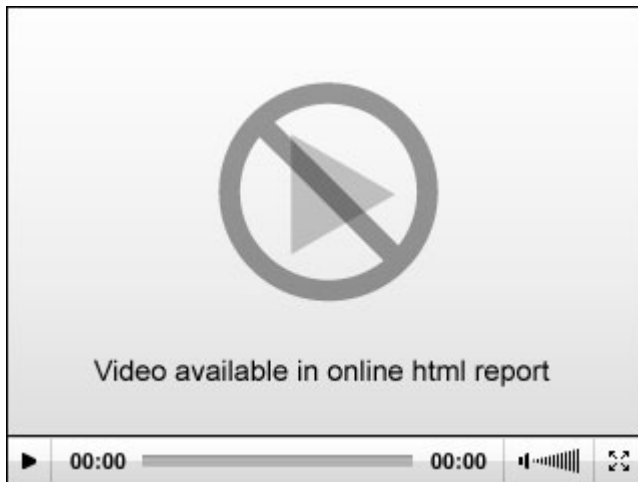

10.0.B Item 2(Picture)

10.0.B Item 3(Video)

**10.1.B** Filter location (see photo). The arrow on the filter should always point towards the blower.



10.1.B Item 1(Picture) upstairs hallway ceiling

10.1.B Item 2(Picture) master bedroom ceiling

**10.2.B (1)** The exterior electrical box for the Heat Pump is rusted on the outside and on the inside. Recommend it be painted or replaced to prevent further rusting. If replaced a qualified electrician should perform replacement.

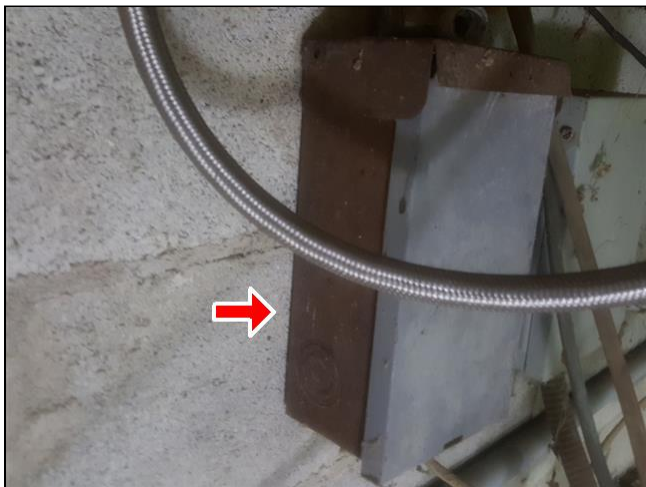

10.2.B Item 1(Picture)

**10.2.B (2)** The disconnect for the Heat Pump at the right side of the home is missing a cover inside the box to protect the wiring. This is a safety issue especially due to no lock on the box cover. The wires are exposed. A child or person can be shocked if wires are tampered with which may result in a death or injury. Recommend a qualified electrician correct and repair for safety.

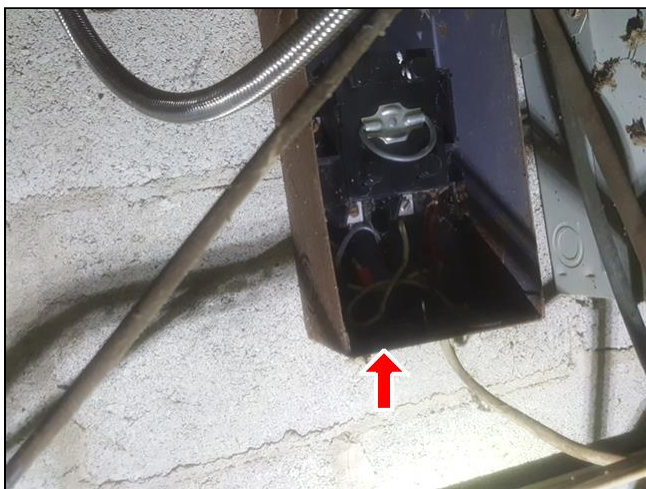

10.2.B Item 2(Picture)



**10.2.B (3)** The aqua guard safety switch does not appear to be working. Water was in the tray and the switch was in contact with the water, yet the unit remained on. Recommend a qualified HVAC contractor repair or replace as needed to prevent a water leak occurring in the attic which will damage ceiling and insulation in the attic. Also refer to note 10.0.B(3).



10.2.B Item 3(Picture)

**10.3.B** Location of the condensate drain line to exterior. (see photo)



10.3.B Item 1(Picture)

**10.4.B** Never fully close any register in a particular room(s). This can place stress on the blower fan of your unit and may shorten it's life span. It is okay to partially close registers so long as there is an airflow being pushed through. This is for your information.

Here is an article explaining [why supply and return ducts must be open and clear](#).

**10.7.B** The ambient air test was performed by using thermometers at the registers closest to the blower to determine if the difference in temperatures of the supply and return air are between 14 degrees and 22 degrees which indicates that the unit is cooling as intended. The supply air temperature on your system read 52 degrees, and the return air temperature was 71 degrees. This indicates the range in temperature drop is normal.

**10.8.B** Check with the owner to verify when the Heat Pump was serviced last. If it hasn't been serviced in the past 12 months, would **strongly** recommend having the unit serviced to ensure efficient and safe operation of the unit, especially due to the unit was not tested in the heating mode.

The heating and cooling system of this home was inspected and reported on with the above information. While the inspector makes every effort to find all areas of concern, some areas can go unnoticed. The inspection is not meant to be technically exhaustive. The inspection does not involve removal and inspection behind service door or dismantling that would otherwise reveal something only a licensed heat contractor would discover. Please be aware that the inspector has your best interest in mind. Any repair items mentioned in this report should be considered before purchase. It is recommended that qualified contractors be used in your further inspection or repair issues as it relates to the comments in this inspection report.

# Repair/ Replace General Summary



**TALON**  
Home Inspections

**Talon Home Inspections, LLC**

**4101 Tates Creek Centre Drive  
Suite 150 - PMB 312  
Lexington, KY, 40517  
(859) 447 0050**

**Customer**

Mrs. Gail Schneider

**Address**

780 Nutfield Way  
Richmond KY 40475

The following items or discoveries indicate that these systems or components **do not function as intended** or **adversely affects the habitability of the dwelling;** or **warrants further investigation by a specialist,** or **requires subsequent observation.** This summary shall not contain recommendations for routine upkeep of a system or component to keep it in proper functioning condition or recommendations to upgrade or enhance the function or efficiency of the home. This Summary is not the entire report. The complete report may include additional information of concern to the customer. It is recommended that the customer read the complete report.

## 1. Structural Components



### 1.7 Ventilation of Foundation Area (crawl space or basement)

#### Repair or Replace

The basement window at the rear right side of the home is at or near ground level. This can allow water entry into the basement. Water intrusion in a basement can lead to more costly repairs and cause mildew or mold to form. Recommend a half-round window well be installed where needed. The dirt inside the well should be replaced with approximately four inches of gravel. A couple of inches clearance between the gravel and window opening is recommended. Recommend a general contractor correct as needed.

## 1. Structural Components



1.7 Item 1(Picture)

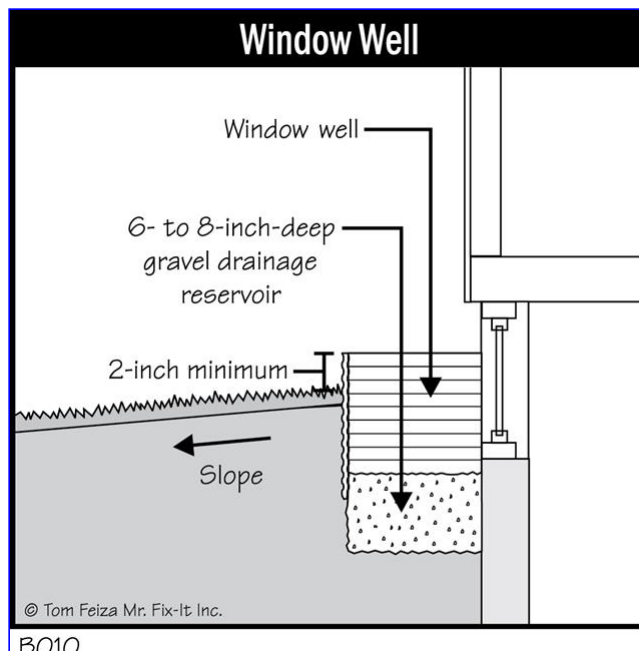

1.7 Item 2(Picture)

## 2. Roofing / Chimneys / Roof Structure and Attic



### 2.1 Roof Flashings Repair or Replace

(2) Where the wall and roof intersects at the top level of the home it is recommended that a 2 inch gap is needed between the siding and the roof to prevent water absorption to prevent the ends of the wood siding from deterioration. Cannot determine if a metal flashing has been installed. This area is more prone for water leakage which can lead to the deterioration of the wood structure and framing of the roof and damage to the wall framing if a flashing is not installed. Recommend a qualified roofing contractor further evaluate, correct and repair as needed to ensure water leakage does not occur and to prevent the wood siding from rotting underneath.



2. Roofing / Chimneys / Roof Structure and Attic



2.1 Item 1(Picture) front of home



2.1 Item 2(Picture) front of home



2.1 Item 3(Picture) rear of home

2. Roofing / Chimneys / Roof Structure and Attic

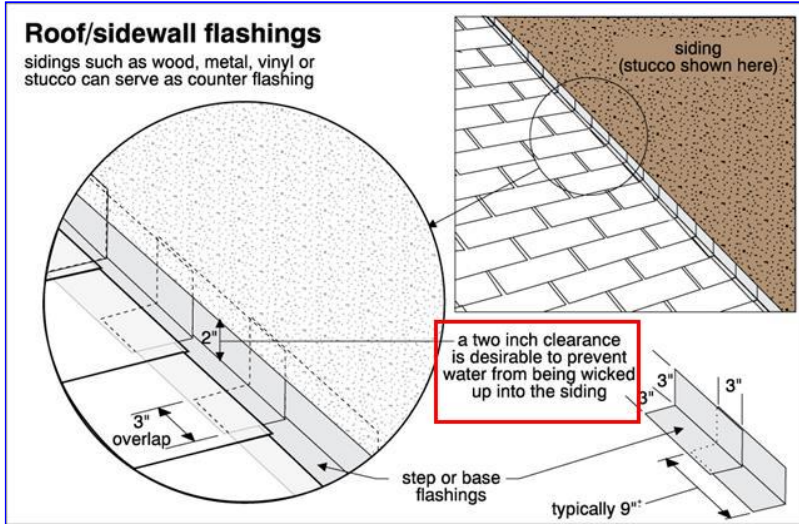

2.1 Item 4(Picture)

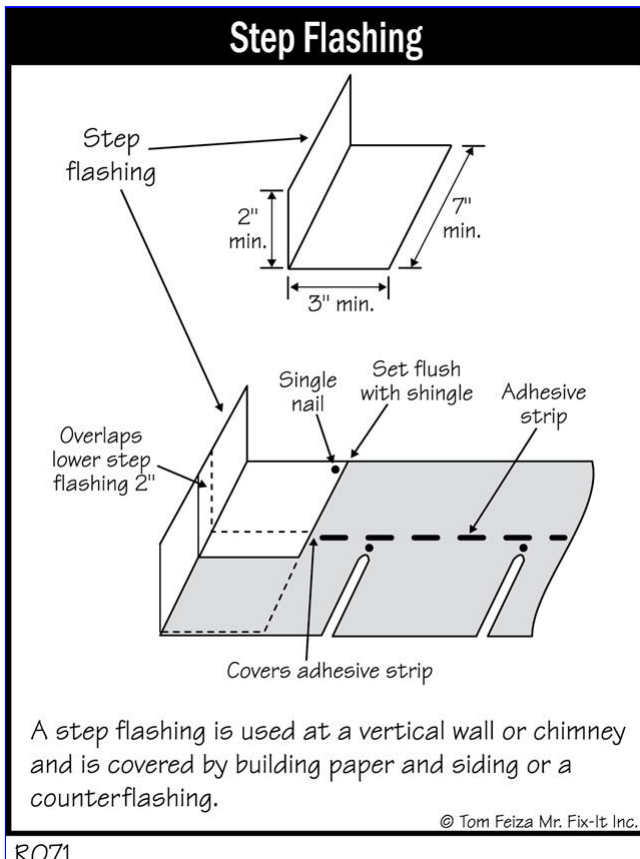

R071

2.1 Item 5(Picture)

**2.4 Roof Drainage Systems (drip edge, gutters, downspouts, and splashblocks)**  
**Repair or Replace**

(3) The downspout extension has deteriorated at the join at the front center of the home. Leakage maybe be experienced here when it rains which could lead to basement leakage. Recommend replacement as needed.

## 2. Roofing / Chimneys / Roof Structure and Attic



2.4 Item 3(Picture) front center of home

(4) Gutters and downspouts are missing at the top roof of the home and should be installed to prevent deterioration of the roof shingles below and to avoid spilling roof runoff around the building if current downspouts cannot adequately drain roof runoff efficiently- a potential source of water entry into the basement or water damage. Recommend a qualified contractor install a gutter system at the top level of the home. Ensure that the downspouts drain directly into the lower gutter and not on the roof.



2.4 Item 4(Picture)



2.4 Item 5(Picture) front of home

(5) The gutter(s) where indicated in the photos, especially where they drain into the downspouts, are full of debris and need to be cleaned. The debris in gutters can also conceal rust, deterioration or leaks that are not visible until cleaned, and I am unable to determine if such conditions exist. Gutters require cleaning to avoid spilling roof runoff around the building - a potential source of water entry or water damage, and/or the fascia could become damaged. Recommend cleaning the gutters as needed. You may wish to consider installing gutter guards due to trees surrounding the home.



2. Roofing / Chimneys / Roof Structure and Attic



2.4 Item 6(Picture) front right corner of home



2.4 Item 7(Picture) rear left side of home



2.4 Item 8(Picture) right side of home

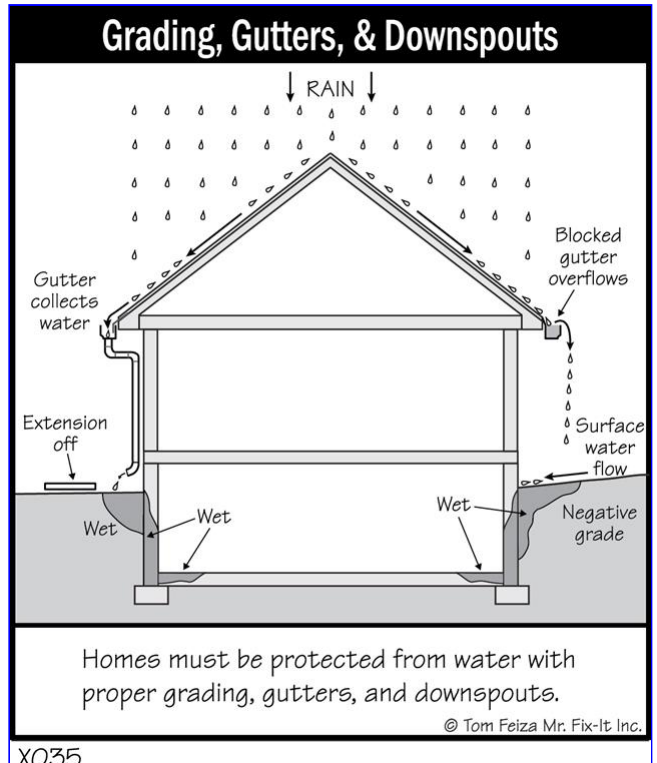

X035

2.4 Item 9(Picture)



2. Roofing / Chimneys / Roof Structure and Attic

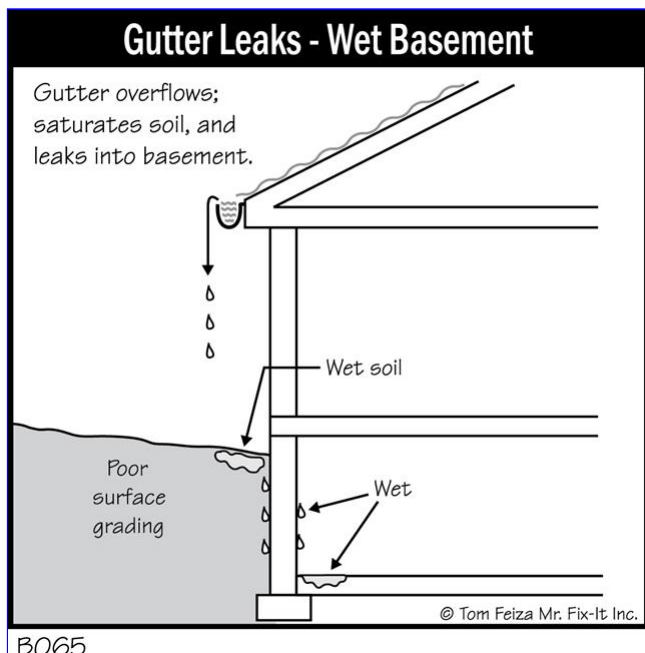

B065

2.4 Item 10(Picture)

(6) The gutter needs to be tightened against fascia and sealed at the front left side of the home. This may cause water to pool in this area and may cause the gutter to pull away and detach from the fascia. Recommend a general contractor repair as needed.



2.4 Item 11(Picture)



2.4 Item 12(Picture)

(7) The gutter leaks at the seam where indicated in the photos. Evidence of minor leakage was observed in this area during the inspection. Repairs are needed to prevent possible deterioration of the fascia and/or soffit via water intrusion. Recommend a general contractor repair as needed.

2. Roofing / Chimneys / Roof Structure and Attic

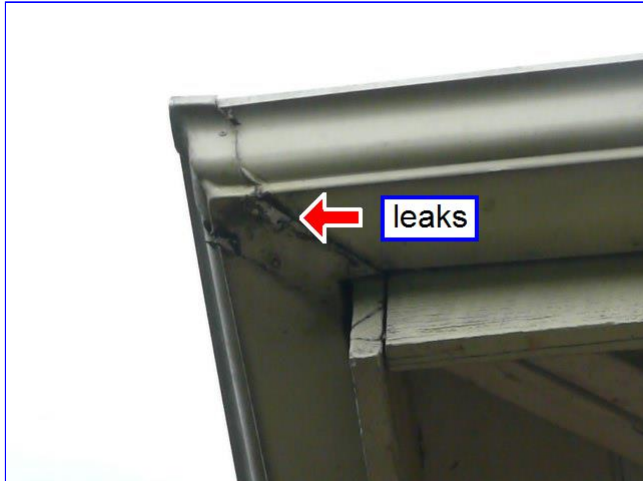

2.4 Item 13(Picture) rear right corner of home

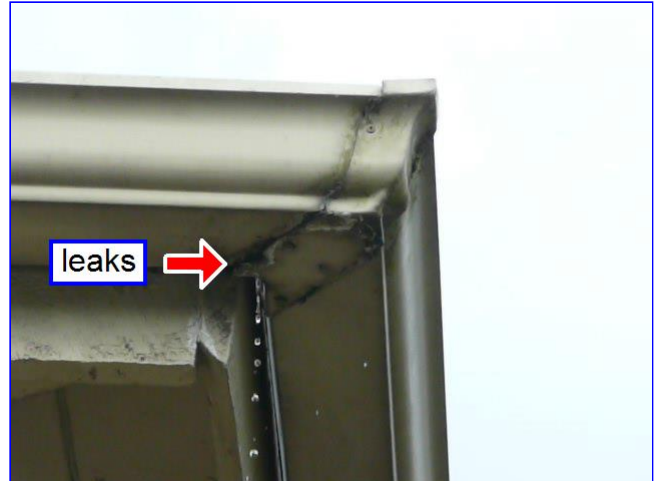

2.4 Item 14(Picture) front left corner of home

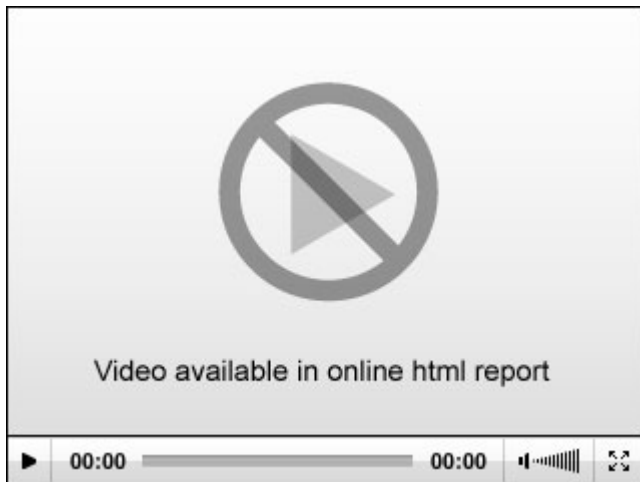

2.4 Item 15(Video) front left corner of home

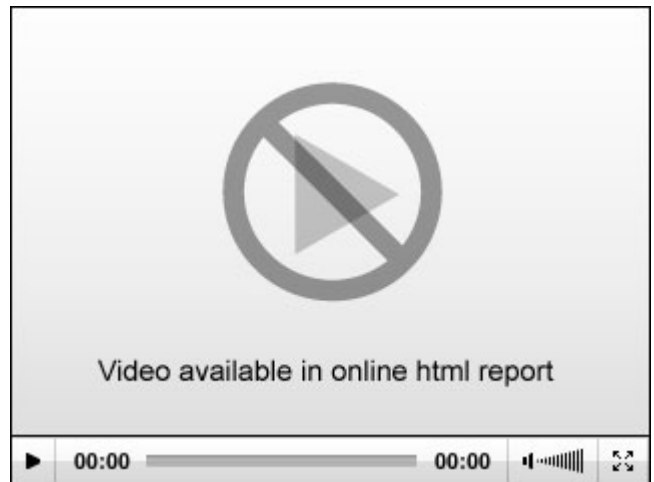

2.4 Item 16(Video) rear right corner of home

2.5 Attic Access

**Repair or Replace**

(1) The pull down ladder in the garage is not assembled properly at the bottom stile, leaving the bottom stile unstable and not sitting flush against the mid stile for support against the floor. This is a safety issue. If it were to fail when someone is using it they could be severely hurt. Recommend that the stairs be repaired or replaced to prevent injuries.

## 2. Roofing / Chimneys / Roof Structure and Attic



2.5 Item 1(Picture)



2.5 Item 2(Picture)



2.5 Item 3(Picture)

### 2.6 Roof Structure and Attic (Report leak signs or condensation)

#### Repair or Replace

The 2x4 truss above the attic house fan has been cut/modified in the master bedroom attic area. The truss may fail if not repaired correctly. Excess loads on the roof like snow can cause separation if not reinforced. Truss repairs should be approved by an engineer or qualified architect before performing the work involved. Some reinforcement may be recommended by an engineer. For this reason, I **strongly** recommend you contact an engineer or qualified person for a second opinion before closing.

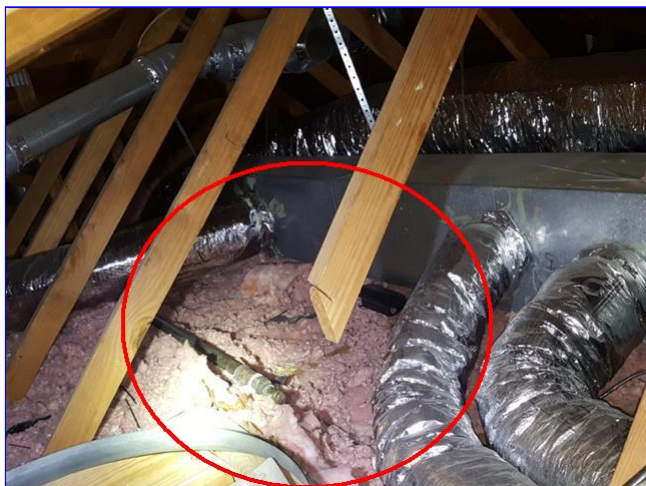
**2. Roofing / Chimneys / Roof Structure and Attic**

2.6 Item 1(Picture)

**2.10 Attic Electrical (Visible Electric Wiring in Attic, Switches, Outlets, and Light Fixtures)  
Repair or Replace**

(1) Loose wiring in the garage attic should be secured to prevent tripping accidents. This is a safety issue. Recommend a licensed electrician secure where needed.



2.10 Item 1(Picture) garage

(2) The wiring installation of the power vent in the garage attic is non-standard. It is suspected that an amateur, rather than a licensed electrician performed the installation. Splices in electrical wiring should be enclosed in junction boxes and fitted with cover plates, not covered in insulation tape. This is a safety issue. Recommend a licensed electrician repair as needed to prevent accidental electric shocks.



## 2. Roofing / Chimneys / Roof Structure and Attic



2.10 Item 2(Picture)

## 3. Exterior



### 3.1 Wood Siding and Trim Repair or Replace

(3) The wood siding has cracked and is loose in some areas at the front of the home. See photos for location. These areas need to be repaired or replaced to prevent further water intrusion which will lead to further deterioration of the siding and possible rotting. Over time deterioration of the wall sheathing and/or framing may occur and possible mold may occur. Recommend a qualified contractor further access damaged areas and repair or replace as needed.

**3. Exterior**

3.1 Item 2(Picture) front right side of home

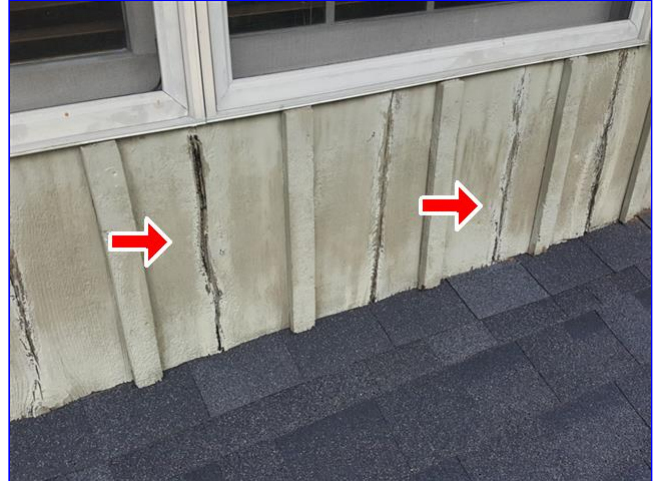

3.1 Item 3(Picture) front right side of home



3.1 Item 4(Picture) front left side of home

**3.5 Porches, Balconies, Areaways, Stoops, Steps, and Applicable Railings  
Repair or Replace**

(1) The guard rail for the balcony porch on the right side of the home have large spaces between the ballusters. This is a safety issue. A fall or injury could occur if not corrected as this condition could allow a child or pet to fall through which may result in a death. The current recommendations are for spacing to be no more than 4" to prevent these accidents. A qualified contractor should make the necessary repairs and corrections where needed for safety.

3. Exterior

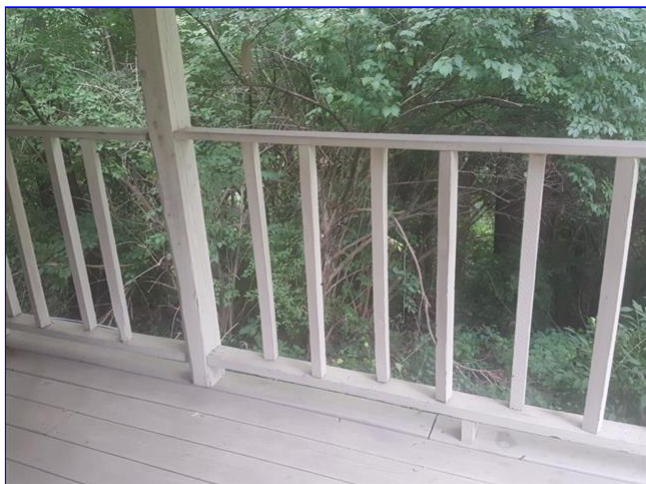

3.5 Item 1(Picture)

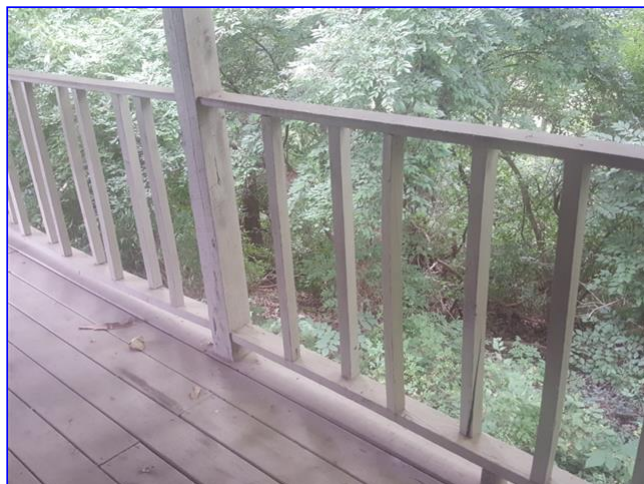

3.5 Item 2(Picture)

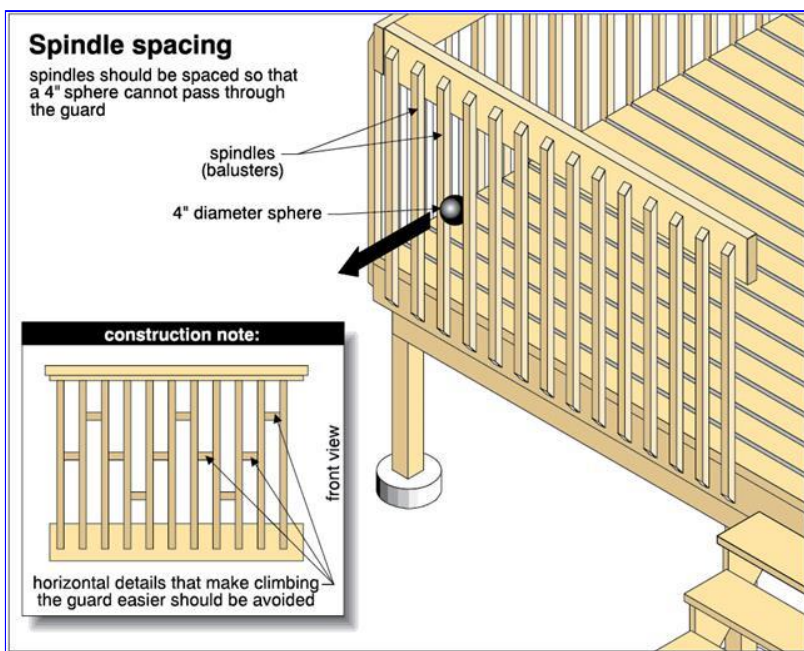

3.5 Item 3(Picture)

(2) Recommend a guard rail be installed at the front porch on the right side to prevent a fall from occurring which may result in an injury of a person. This is a potential safety issue. The railing needs to be at least 36 inches high and balusters need spacing to be at least 4 inches. Recommend a qualified contractor install one for safety.



### 3. Exterior



3.5 Item 4(Picture) front right side of home

(3) 2x6s are installed for handrails for the basement staircase at the left side of the home and are not considered "gripable" by industry standards. This is a safety issue and an injury could occur if not corrected. Recommend that a standard approved handrail be installed for safety by a general contractor.



3.5 Item 5(Picture)

#### 3.6 Decks, Structure, Railings, Stairs Repair or Replace

(1) The guard rail for the rear deck and the staircase have large spaces between the ballusters. This is a safety issue. A fall or injury could occur if not corrected as this condition could allow a child or pet to fall through which may result in a death. The current recommendations are for spacing to be no more than 4" to prevent these accidents. A qualified contractor should make the necessary repairs and corrections where needed for safety.



3. Exterior



3.6 Item 1(Picture)

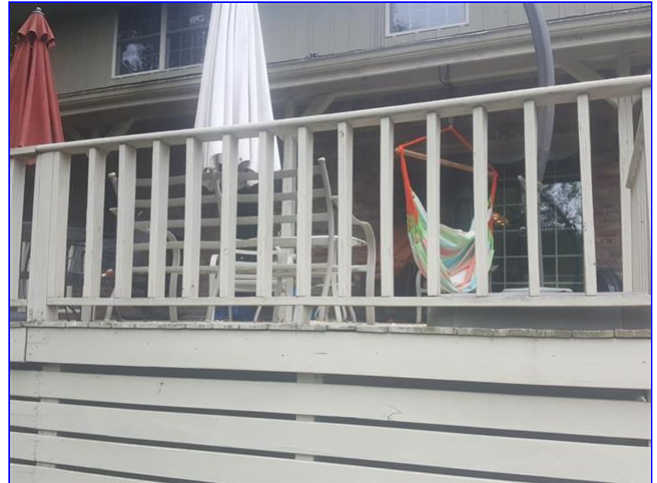

3.6 Item 2(Picture)



3.6 Item 3(Picture)

(2) 2x4s are installed for handrails for the deck staircase and are not considered "gripable" by industry standards. This is a safety issue and an injury could occur if not corrected. Recommend that a standard approved handrail be installed for safety by a general contractor.



3.6 Item 4(Picture)

### 3. Exterior



(3) The guard rail for rear deck is loose, unstable and not secured properly. This is extremely dangerous and is a major safety concern. It may fail under a medium or heavy force or if someone was pushed against or was leaning on the railing. For your safety it should be strengthened and secured. Recommend a qualified contractor repair as needed before closing.

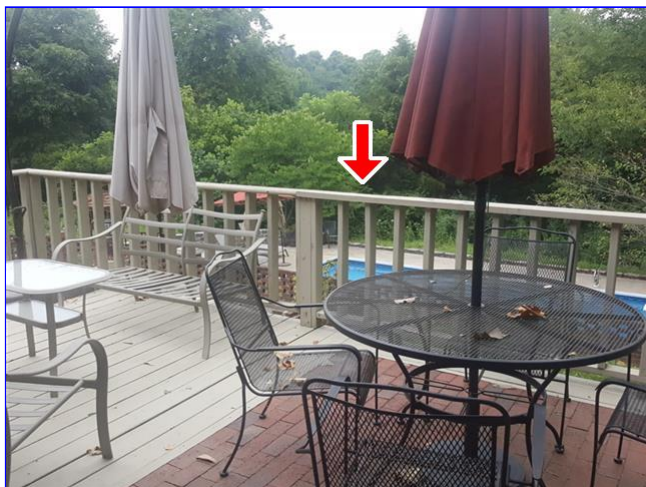

3.6 Item 5(Picture)



3.6 Item 6(Picture)

(4) Recommend a guard rail be installed for the staircase at the rear right side of the home to prevent a fall from occurring which may result in an injury of a person. This is a potential safety issue. The railing needs to be at least 36 inches high and balusters need spacing to be at least 4 inches. Recommend a qualified contractor install one for safety.



3.6 Item 7(Picture)

### 4. Garage/Carport

#### 4.3 Garage Door/Operators (Report whether or not doors will reverse when met with resistance)

##### Repair or Replace

(1) The door button is lower than the manufacturers recommended 5 feet above the floor. This is a safety issue. Recommend this be raised to prevent unauthorized use by children as an injury may occur or damage to a motor vehicle when the door is opened or closed automatically. A qualified licensed electrician is recommended for correcting.

## 4. Garage/Carport



4.3 Item 1(Picture)

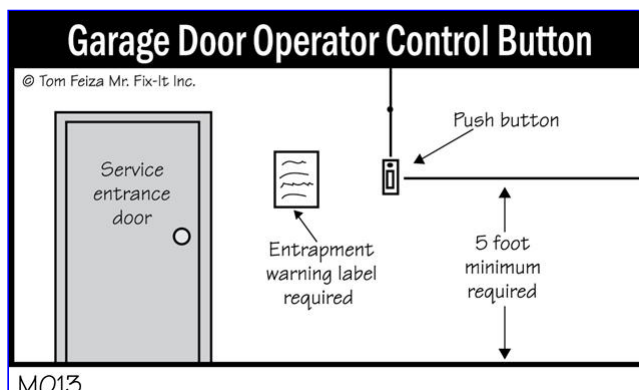

M013

4.3 Item 2(Picture)

(2) The garage door opener electric eyes are installed too high. There is a serious risk of injury, particularly to children or pets, under this condition. The eyes should be placed 4" to 6" off the floor or as otherwise indicated in the installation manual. This should be dealt with immediately by a qualified garage installer.

Note: the door does reverse when eyes are interrupted and under resistance.



4.3 Item 3(Picture)

### 4.7 Steps, Stairways, Balconies and Railings Repair or Replace

Recommend a guard rail be installed at the staircase in the garage to prevent a fall from occurring which may result in an injury of a person. This is a potential safety issue. The railing needs to be at least 36 inches high and balusters need spacing to be at least 4 inches. Recommend a qualified contractor install one for safety.



**4. Garage/Carport**



4.7 Item 1(Picture)

**4.8 Connected Devices and Fixtures (Observed from a representative number operation of ceiling fans, lighting fixtures, switches and receptacles)**

**Repair or Replace**

(2) Openings between the outlet and the cover plate in the garage where indicated in the photo is a serious safety issue. A child or person may place an object inside opening which may contact the connecting wires causing an electrical shock which could lead to a serious injury or death. Recommend a qualified electrician repair as needed for your safety before moving into home.



4.8 Item 1(Picture)

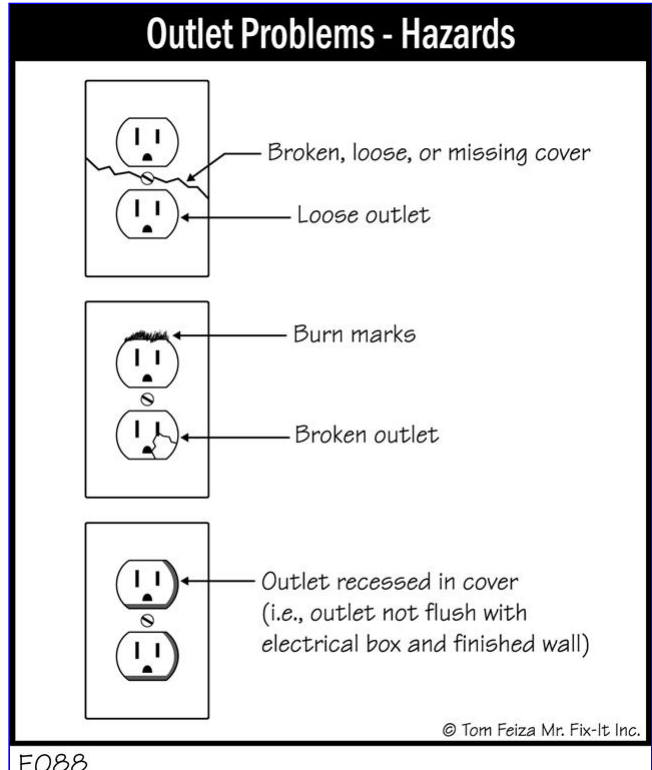

4.8 Item 2(Picture)

(3) The outlet(s) in the garage where indicated in the photo(s) are loose in the ceiling and is missing a cover plate. Electrical issues are considered a hazard until repaired. This is a safety issue that needs to be corrected due to an electric shock or fire from loose connections could occur if not repaired. Recommend a qualified licensed electrical contractor correct as needed.



**4. Garage/Carport**

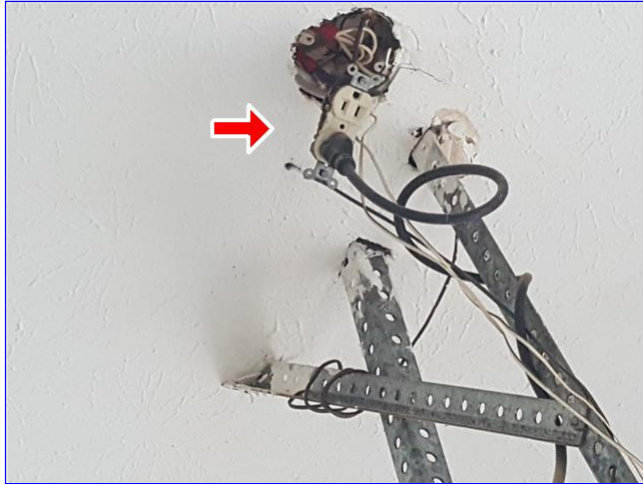

4.8 Item 3(Picture)

**5(A). Kitchen / Components and Appliances Main Kitchen**



**5.1.A Plumbing Drain and Vent Systems**

**Repair or Replace**

The p-trap on the waste line is leaking at the connection underneath the sink in the kitchen. Repairs are needed to stop leaking water from damaging the cabinet bottom or to eliminate moisture that may contribute to fungi growth. A qualified licensed plumber is recommended for repairs as needed.



5.1.A Item 1(Picture)

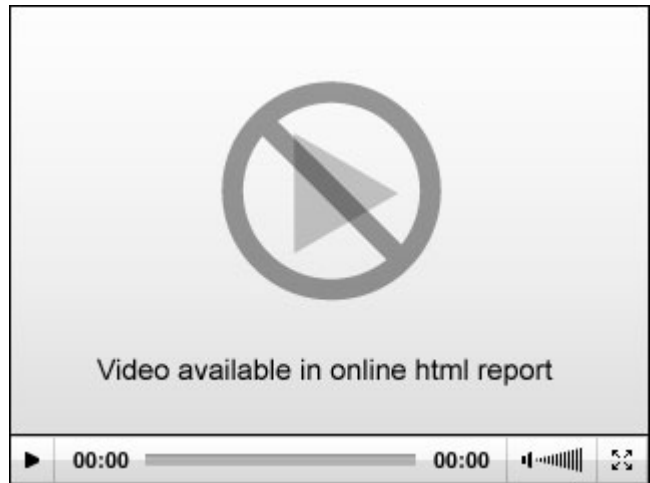

5.1.A Item 2(Video)

**5.2.A Dishwasher**

**Repair or Replace**

The dishwasher drain hose did not perform a loop to create a trap under the sink. The current recommendations for the dishwasher drain lines are for them to be installed as close to the bottom of the countertop as possible. This creates a water blockage to prevent sewer gases entering the house through the dishwasher. Recommend repair or replace as necessary.

5(A). Kitchen / Components and Appliances Main Kitchen

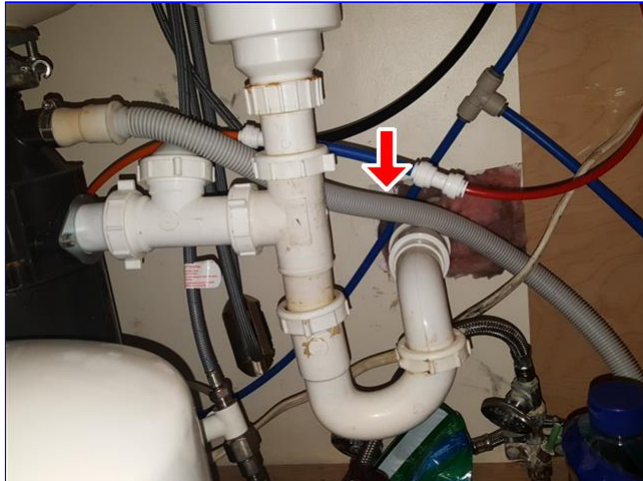

5.2.A Item 1(Picture)

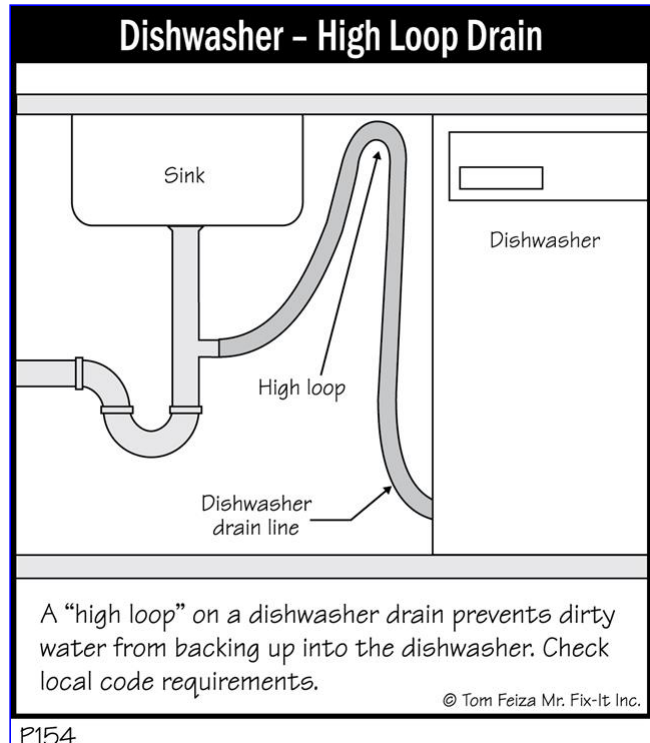

P154

5.2.A Item 2(Picture)

5.10.A Outlets, GFCI (Ground Fault Circuit Interrupters), Wall Switches and Fixtures (Lights and Ceiling Fans)

Repair or Replace

(2) The outlet(s) are not GFCI protected in the kitchen in the home. Although GFCIs may not have been required at the time that this house was built, these are now required and recommended for safety within any water source as a safety feature when any changes to the outlets are made. GFCI outlet offers protection from shock or electrocution. Recommend a licensed electrician correct as needed prior to moving in.

(3) The outlet(s) in the kitchen where indicated in the photo(s) are loose at the wall or in the outlet box. Electrical issues are considered a hazard until repaired. This is a safety issue that needs to be corrected due to an electric shock or fire from loose connections could occur if not repaired. Recommend a qualified licensed electrical contractor correct as needed.



5.10.A Item 1(Picture)

## 5(B). Kitchen / Components and Appliances Basement Kitchen



### 5.0.B Plumbing Water Supply, Faucets, Shutoffs, and Fixtures

#### Repair or Replace

(1) The hot and cold water lines are connected to the faucets at the sink in reverse from there normal positions in the basement kitchen. This could result in scalding burns. Recommend they be changed to the accepted normal locations with the cold water valve on the right side of the fixture. Recommend a licensed plumber correct as needed.



5.0.B Item 1(Picture)

### 5.1.B Plumbing Drain and Vent Systems

#### Repair or Replace

The waste line is leaking at the connection underneath the left sink in the basement kitchen. Repairs are needed to stop leaking water from damaging the cabinet bottom or to eliminate moisture that may contribute to fungi growth. A qualified licensed plumber is recommended for repairs as needed.



5.1.B Item 1(Picture)

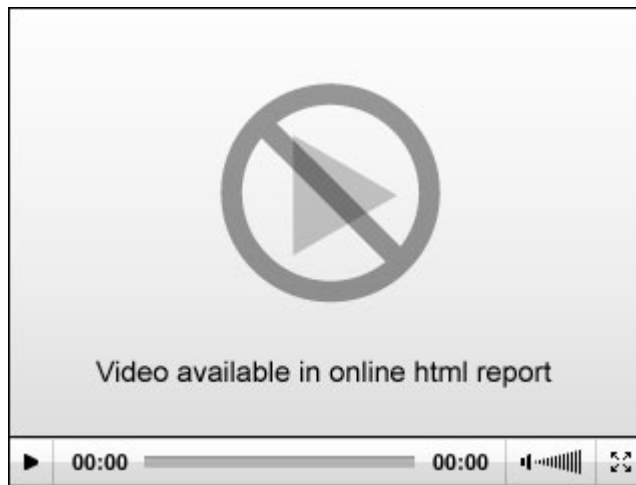

5.1.B Item 2(Video)

### 5.2.B Ranges/Ovens/Cooktops

#### Repair or Replace

The "Anti Tip" bracket for the range has not been installed as required by manufacturer's installation instructions. This could allow the range to tip if it is pulled or if the oven door is pushed down or stepped on. This is a safety issue. A tip over hazard exists for small children and a serious injury or death could occur. Strongly recommend the bracket be installed for safety around small children or others. [Information about "anti tip" bracket](#)

## 5(B). Kitchen / Components and Appliances Basement Kitchen



5.2.B Item 1(Picture)

### 5.6.B Outlets, GFCI (Ground Fault Circuit Interrupters), Wall Switches and Fixtures (Lights and Ceiling Fans)

#### Repair or Replace

(2) The outlets in the basement kitchen are not GFCI protected. GFCI (Ground fault circuit interrupters) outlets should be considered for installation as a safety upgrade in all locations where water is present if the outlets are not presently connected to a GFCI. They are now required in all bathrooms, kitchen, unfinished basements, garages, exterior outlets, or other locations within 6' of a water source or sink. GFCI outlets may not have been required when this house was built but should be considered for safety. Personally recommend a licensed electrician replace as needed.



5.6.B Item 1(Picture)

### 5.7.B Clothes Dryer Vent Piping

#### Repair or Replace





(1) A pleated Foil flex pipe is currently installed from the dryer to the exhaust vent. The current recommendations are for dryer vents to be heavy flexible or solid metal to help prevent crushing and damage from fires. Dryer lint fires are reported to be the third leading cause of fires. Exhaust ducts should be constructed of minimum 0.016 inch thick rigid metal ducts, having smooth interior surfaces with joints running in the direction of air flow. Exhaust ducts shall not be connected with sheet metal screws or fastening means which extend into the duct. All dryer vents should be disconnected and cleaned twice a year. This is a very common cause of fires. Recommend replacing duct for proper operation and for your safety using a qualified contractor.



5(B). Kitchen / Components and Appliances Basement Kitchen



5.7.B Item 1(Picture)

Choose these	Avoid these
 <p data-bbox="212 1129 537 1192"><b>RIGID METAL</b> These are least likely to sag.</p>	 <p data-bbox="652 1129 977 1192"><b>FLEXIBLE PLASTIC</b> These are likely to sag and trap lint.</p>
 <p data-bbox="212 1600 537 1663"><b>FLEXIBLE METAL</b> Also good, these hold their shape if bent.</p>	 <p data-bbox="652 1600 977 1663"><b>FLEXIBLE FOIL</b> These may look like flexible metal but don't hold their shape if bent.</p>

5.7.B Item 2(Picture)

5(B). Kitchen / Components and Appliances Basement Kitchen

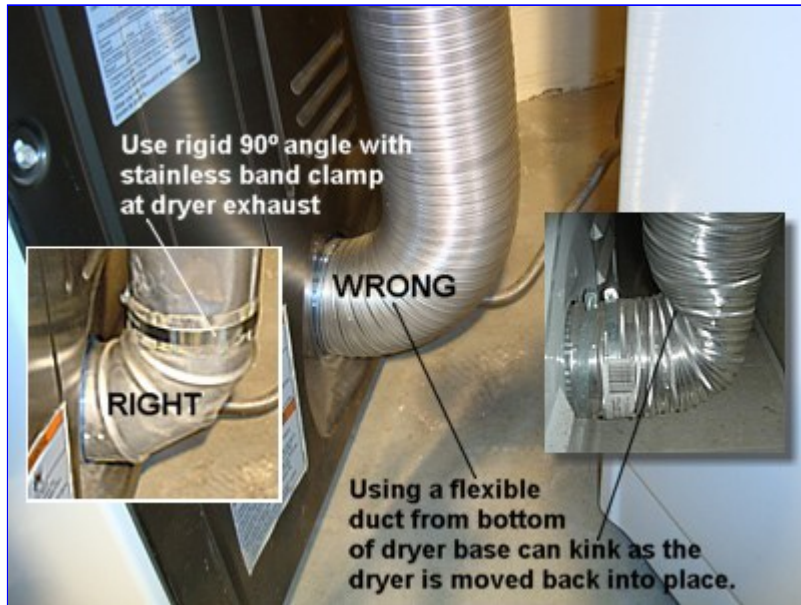

5.7.B Item 3(Picture)

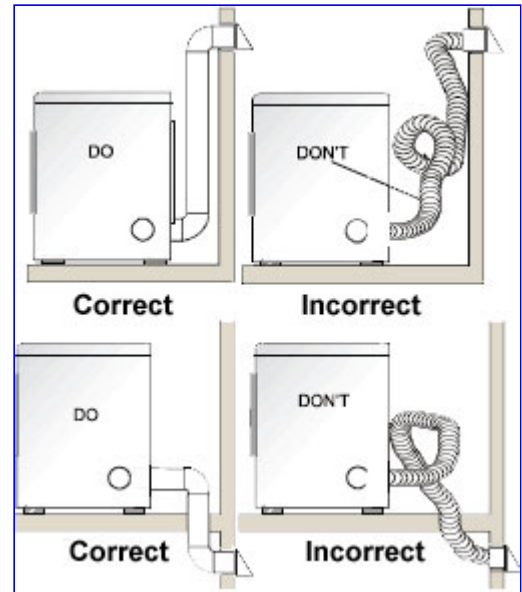

5.7.B Item 4(Picture)

6. Rooms



6.3 Steps, Stairways and Railings

Repair or Replace

(1) The balcony railing is loose/unstable between the dining and living room. This is extremely dangerous and is a safety concern. This could collapse if someone was pushed against or was leaning on the railing. Recommend repair by a qualified contractor before closing.



6.3 Item 1(Picture) dining room

(2) The stair case rail on the on the left side leading to the upstairs is unstable and not secured properly. This is extremely dangerous and is a safety concern. It may fail under a medium or heavy force or if someone was pushed against or was leaning on the railing. For your safety it should be strengthened and secured. Recommend a qualified contractor repair as needed before closing.

**6. Rooms**

6.3 Item 2(Picture)

**6.7 Outlets, GFCI, Wall Switches and Fixtures (Lights and Ceiling Fans)  
Repair or Replace**

(2) The outlet(s) in the basement hallway where indicated in the photo(s) are loose at the wall or in the outlet box. Electrical issues are considered a hazard until repaired. This is a safety issue that needs to be corrected due to an electric shock or fire from loose connections could occur if not repaired. Recommend a qualified licensed electrical contractor correct as needed.



6.7 Item 3(Picture)



6.7 Item 4(Picture)

(3) Recommend sealing the gap between the wall and the outlet in the basement hallway where indicated in the photo(s) to prevent children being electrocuted by placing objects inside the opening. This is a serious safety issue. Recommend a qualified electrician and/or a general contractor repair as needed.

## 6. Rooms



6.7 Item 5(Picture)



6.7 Item 6(Picture)

### 6.8 Smoke and Carbon Monoxide Detectors Repair or Replace

(3) There is no visible permanent carbon monoxide detector found in the home. It is recommended that one be installed according to the manufacturer's instructions for safety and to prevent a death from carbon monoxide poisoning due to the water heater located at the upstairs closet.

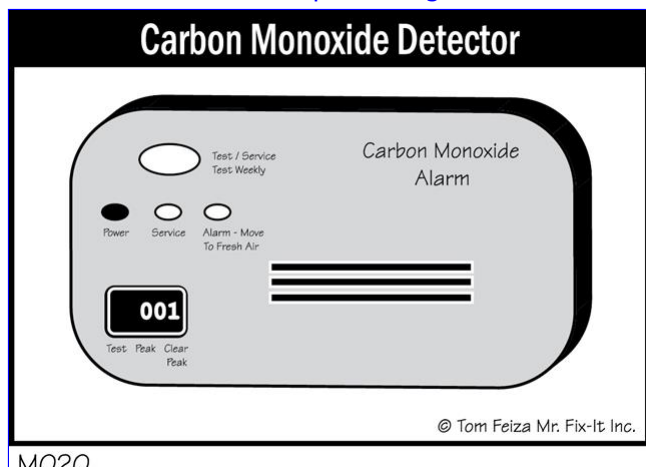

M020

6.8 Item 1(Picture)

## 7. Bathroom and Components



### 7.4 Plumbing Water Supply, Shutoffs, Faucets, and Fixtures Repair or Replace

(1) The drain stopper is missing in the bath tub at the 2nd bathroom. Recommend a qualified licensed plumber install one or a rubber stopper can be used.

(2) The drain control stopper is not connected at the left sink and does not function in the master bathroom. Recommend correcting to allow easy use of the drain lever and to ensure it functions properly. Repair or correct as needed.



## 7. Bathroom and Components



7.4 Item 1(Picture)

### 7.5 Plumbing Drain and Vent Systems Repair or Replace

(1) Flexible ridged pipe is being used for the connection to the drain line under the sink in the master bathroom. The pipe ridges will hold and trap debris which could clog the drain. Plan on cleaning the drain from time to time. Smooth pipe would be better but may be difficult to fit to the existing drain lines. Recommend you seek a qualified licensed plumber to evaluate and correct if needed as this type of work is not to standard workman like practices.



7.5 Item 1(Picture)

(2) Rubber hose pipe is being used for the connection to the drain line under the sink in the basement bathroom. The pipe connections may leak in the future. Recommend you seek a qualified licensed plumber to correct as needed as this type of work is not to standard workman like practices.

## 7. Bathroom and Components



7.5 Item 2(Picture)

### 7.6 Outlets, GFCI (Ground Fault Circuit Interrupters), Wall Switches and Fixtures Repair or Replace

(2) The outlet(s) in the 2nd bathroom are GFCI protected however when tripped you need to reset them at the panel box at the appropriate breaker No. 9. This is for your information.

(3) The outlet(s) are not GFCI protected in the Master and basement bathrooms where indicated in the photos. Although GFCIs may not have been required at the time that this house was built, these are now required and recommended for safety within any water source as a safety feature when any changes to the outlets are made. GFCI outlet offers protection from shock or electrocution. Recommend a licensed electrician correct as needed prior to moving in.

7. Bathroom and Components



7.6 Item 1(Picture) master bathroom



7.6 Item 2(Picture) basement bathroom



7.6 Item 3(Picture) basement bathroom

### Safety of GFCI vs. Breaker

20-amp GFCI outlet

Water outside

Radio shorts to man. GFCI trips power off at .005 amps within 1/40 of a second. NO SHOCK.

20-amp outlet

Water outside

Radio shorts to man. 20-amp breaker turns power off at 20 amps. SHOCK!

OUCH! Always use GFCI-protected circuits near water. A .005 amp shock should not hurt you. A 20-amp shock will hurt you – it could light you up like 24 100-watt bulbs before the 20-amp breaker trips.

© Tom Feiza Mr. Fix-It Inc.

E125

7.6 Item 4(Picture)

(4) The outlet in the master bathroom where indicated in the photo is loose at the wall or at the outlet box. Electrical issues are considered a hazard until repaired. This is a safety issue that needs to be corrected due to an electric shock or fire from loose connections could occur if not repaired. Recommend a qualified licensed electrical contractor correct as needed.

## 7. Bathroom and Components

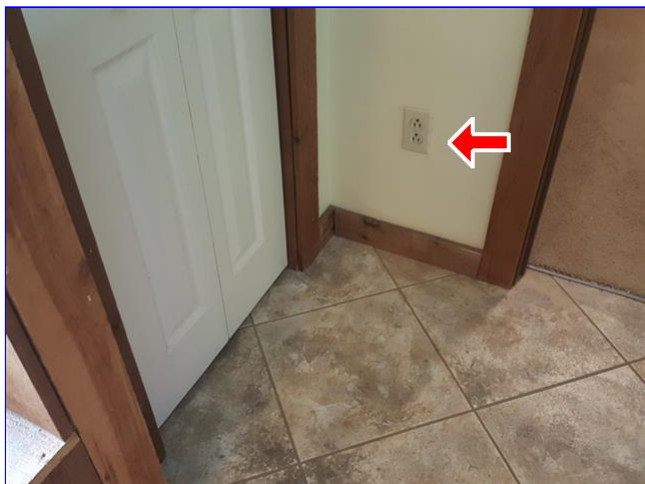

7.6 Item 5(Picture)

### 7.8 Toilet(s)

#### Repair or Replace

The toilet tank base is loose at the floor in the master bathroom. The screws may need tightening to secure the toilet base to the floor to prevent a water leak between the toilet and the drain line connection. If tightening the screws at the base of the toilet does not secure the toilet, repairs may involve re-setting the toilet on a new wax seal and/or repairs to the floor may be required. Recommend a qualified licensed plumber repair or correct as needed.



7.8 Item 1(Picture)

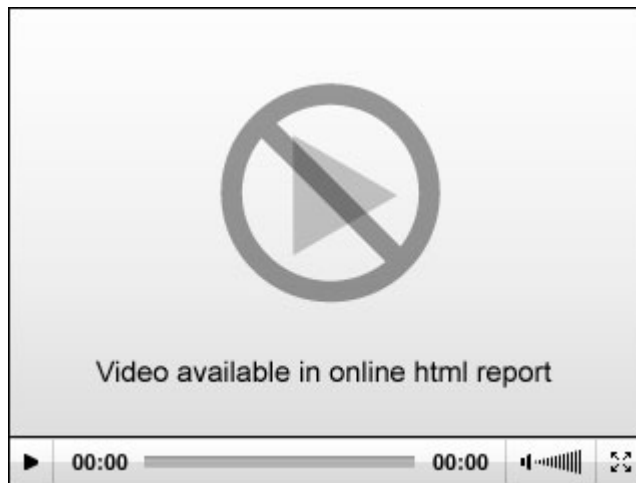

7.8 Item 2(Video)

## 8. Plumbing System



### 8.2 Hot Water Systems and Controls

#### Repair or Replace

(3) The water heater in the upstairs closet was installed some time in 2015 or 2016 due to the age of the unit and does not have an "inspection approved label" by the state plumbing inspector that was visible at the time of inspection. This is a red flag. When the water heater was installed, the owner and the installer are both to submit paper work to the local county so the state plumbing inspector comes out and overlooks the installation to ensure it is up to code. Recommend contacting the owner to ask if this was done. If not, recommend contacting your local county to have there inspector check installation or have a qualified plumber verify installation is correct and up to code before closing.



## 8. Plumbing System



(5) Corrosion and a kink at the hot water supply inlet at the top of the water heater was noted in the basement washer dryer room. This usually occurs when two different types of metals are in contact with each other. This area will eventually leak water. Recommend a qualified plumber further investigate and repair as needed. Due to the age of unit, consideration in replacing unit would be wise before a major leak occurs.



8.2 Item 3(Picture)

(8) There is no strain-relief clamp on the wire where it enters the top of the water heater in the basement. This is a safety issue. A child or person could easily pull the wire out of the heater, touch an energized conductor, and be electrocuted causing possible death. Recommend a qualified licensed electrician repair as needed for safety.



8.2 Item 6(Picture)

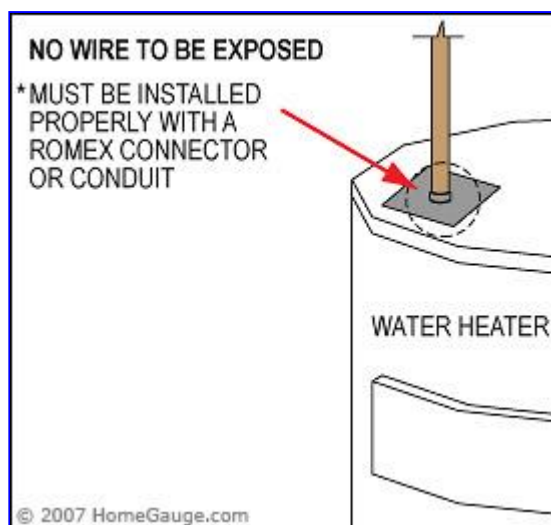

8.2 Item 7(Picture)

### 8.4 Ventilation and Flue Pipes (Water Heater)

#### Repair or Replace

The water heater is located in the closet upstairs. This is a safety issue and can be hazardous to your health. When a gas appliance is located in a small enclosed room it requires combustion air. If the closet doors are closed, there will be inadequate combustion air for the water heater due to only one vent was found. Inadequate combustion can result in excessive amounts of CO (carbon monoxide) being produced and has been known to cause sickness or death. When a gas appliance is placed in a small confined enclosure, it requires proper ventilation. The easiest remedy is to install two metal 6" pipes to obtain air from the attic or the outside. The two openings located high and low with 144 square inches of free space each, or a louvered door with free space of 288 square inches is required.

## 8. Plumbing System



Recommend a qualified plumber further evaluate and make the necessary corrections for your safety prior to closing.

Note: Vent screens that are used for combustion air for a gas appliance **must not have any damper or closing device**. This is a serious safety issue. Recommend replacing vents that are not adjustable.



8.4 Item 1(Picture)



8.4 Item 2(Picture)

## 9. Electrical System



### 9.2 Main and Distribution Panels, Main Overcurrent Device, and Service.

#### Repair or Replace

(1) The panel box is missing an electrician's approval sticker. Many older homes have had modifications made to the electrical for convenience or to add appliances, lights, or receptacles. These modifications may have used the existing circuits in the house instead of installing additional breakers and wiring as required by the code in effect at that time. Be aware that this may result in overloaded breakers or wiring cables. Unfortunately, these conditions cannot be discovered during a general home inspection and may only be discovered when several of the components are used at the same time, resulting in an overloaded circuit and tripped breaker. Due to the findings with some issues in the electrical main panel, **strongly** recommend a qualified electrician further inspect the panel box and wiring and perform a complete electrical system evaluation for improper wiring per the edition of the code which was in effect at the time, correct problems they may find that were not visible at the time of inspection, and make the necessary repairs as needed to ensure the safety of the occupants and condition within the home prior to closing.

(2) There are screws missing from the cover for both the electric panels where indicated in photos. This is a safety issue. The missing cover screws should be installed to prevent easy entry and to prevent moisture from entering the panel box. Recommend a licensed electrician correct as needed for your safety.

9. Electrical System



9.2 Item 1(Picture) main panel

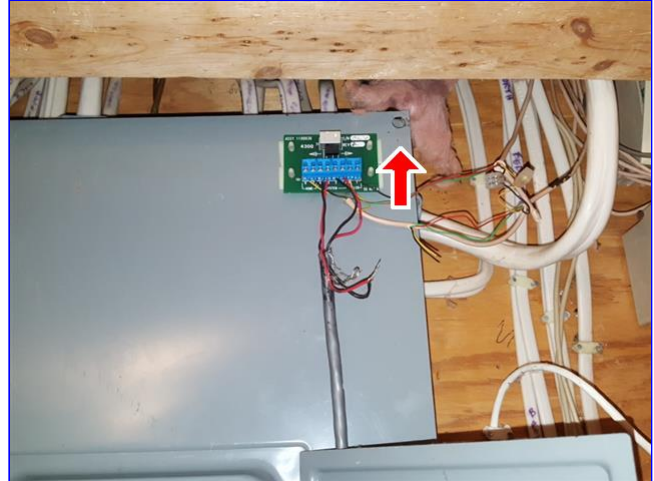

9.2 Item 2(Picture) main panel

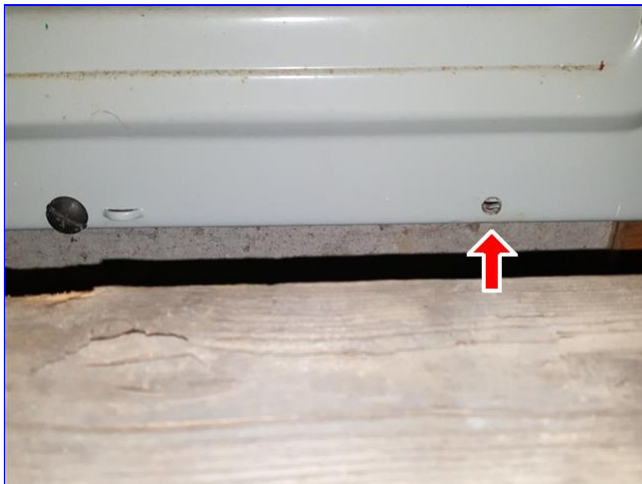

9.2 Item 3(Picture) sub panel

(3) Cable clamps (sometimes referred to as bushings or grommets) are required where wiring passes into the electrical main panel box. Cable clamps serve to protect the wiring from the metal edges of the panel box to prevent a short from occurring or from the panel box becoming energized which can result in a death via electric shock. This is a safety issue. Recommend a qualified licensed electrician repair as needed.

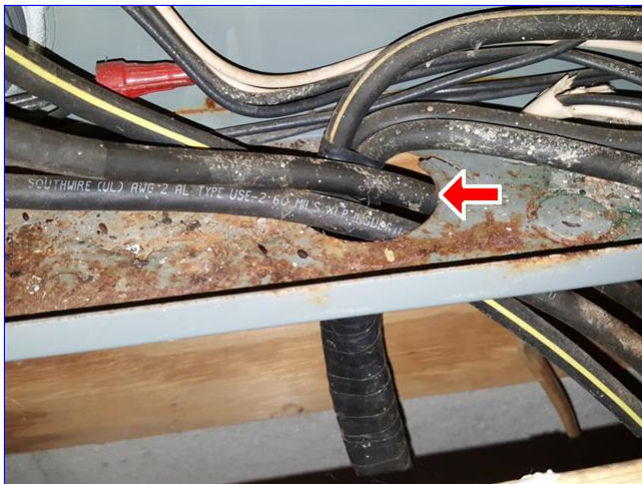

9.2 Item 4(Picture)



## 9. Electrical System



(4) The wiring in the main panel box is near or on top of the panel under where the cover is attached on both sides. This is a serious safety issue. If the panel cover were to be secured with screws on this side it could crush wires which may cause the box to energize resulting in a death via electrocution if the panel box is touched. Recommend a qualified licensed electrician correct for safety as needed.

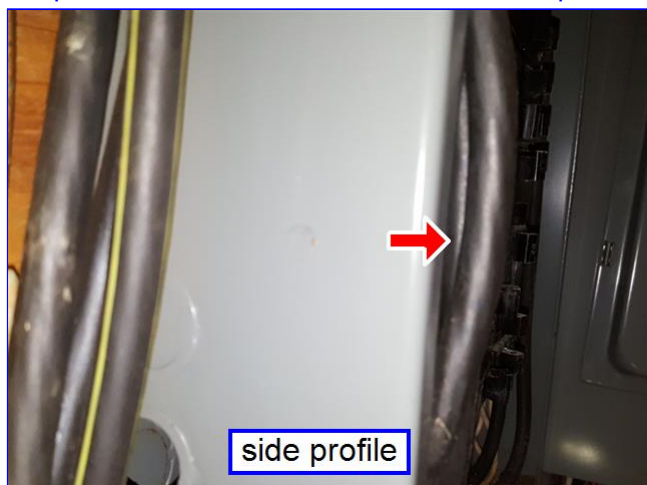

9.2 Item 5(Picture)

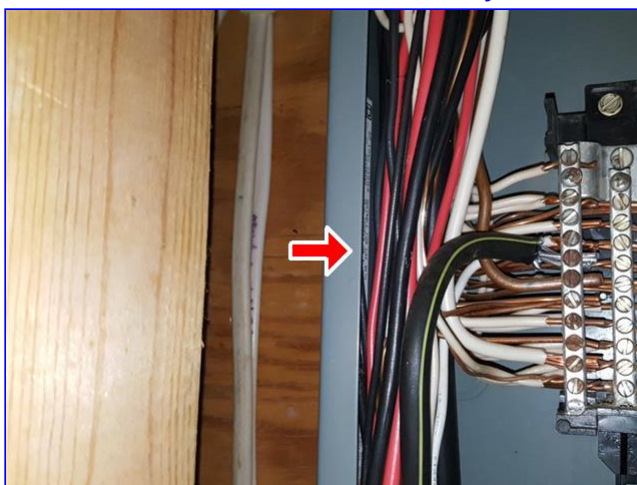

9.2 Item 6(Picture)

(5) No wires should be attached to the panel cover. This makes it difficult to have it removed for inspection and repairs when needed. Recommend an electrician correct as needed.

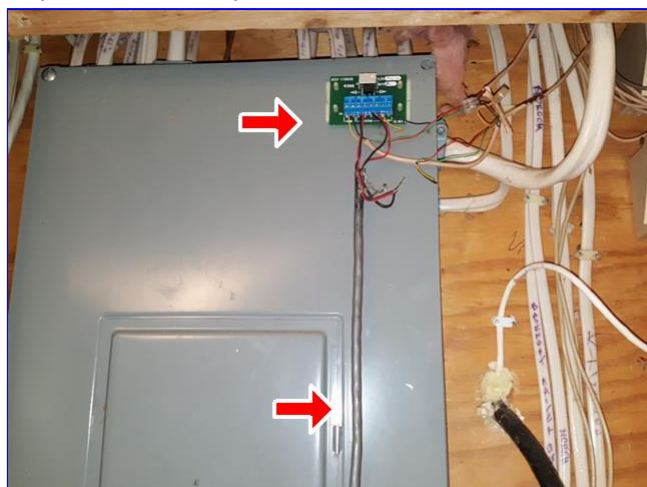

9.2 Item 7(Picture)

(6) Some of the circuit breakers are not labelled at the sub panel cover. This is a safety issue. Could not check if breakers may be overloaded with appliances in the home. The electrical panel should be indexed, identifying each circuit breaker. This will allow for quick de-energizing of a circuit under emergency situations. Recommend the panel be fully labelled to facilitate turning off breakers to circuits. A licensed electrician is recommended to correct as needed.



## 9. Electrical System

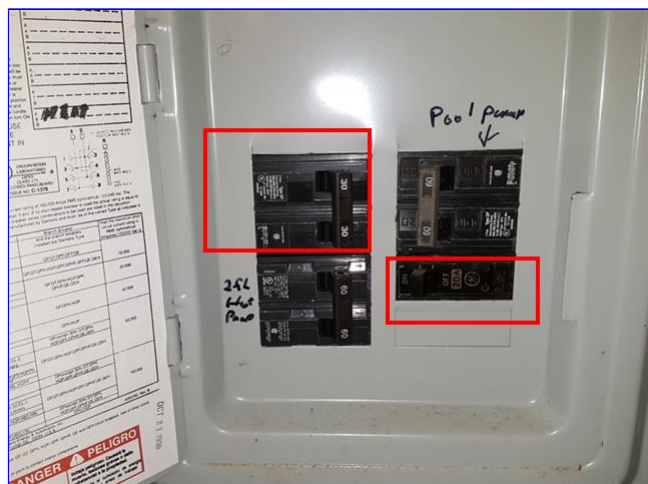

9.2 Item 8(Picture)

### 9.3 Branch Circuit Conductors, Overcurrent Devices and Compatibility of their Amperage and Voltage

#### Repair or Replace

(1) Evidence of scorched wires was noted on the bus bar in the main panel. This indicates that a short is happening and a fire could develop if not repaired or corrected. Strongly recommend a qualified licensed electrician further investigate all wiring in the panel box and correct problems found as needed for your safety.

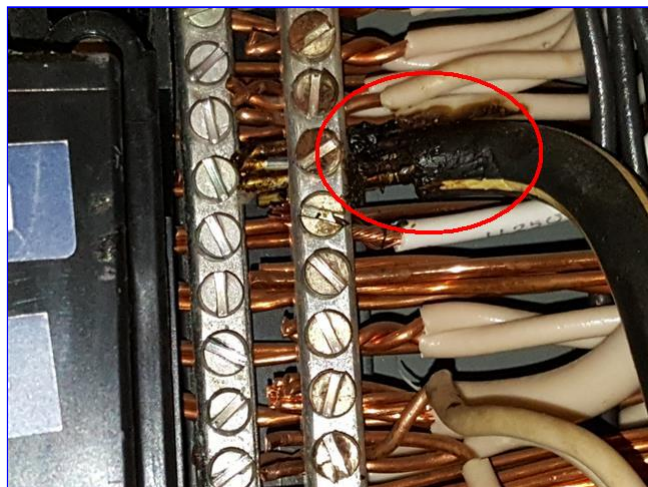

9.3 Item 1(Picture)

(2) The breaker for the Heat Pump on the ground level is oversized in the panel box. Currently it has a 40 amp breaker installed, whereas the data plate on the Heat Pump specifies maximum breaker of 35 amps. The concern with an oversized breaker is typically causing possible damage to the equipment, and if the unit pulls more than 35 amps it could cause the insulation on the wires to start to melt. This will void warranty on the unit. Recommend a qualified HVAC contractor and/or electrician further evaluate to determine if correction is needed.

(3) Multiple tap wiring (more than one hot wire attached to the same breaker) was found in the main panel. This panel and breakers are NOT MADE or DESIGNED to provide adequate holding power for multiple wires on a single breaker. A separate breaker should serve each circuit. This is a very hazardous and is a safety issue. May cause a fire or short. Recommend a qualified electrician further evaluate the panel box for further issues and repair and correct as needed.

9. Electrical System

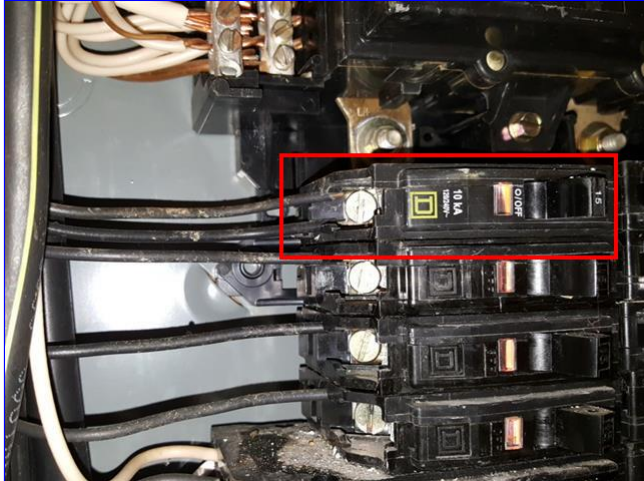

9.3 Item 2(Picture)

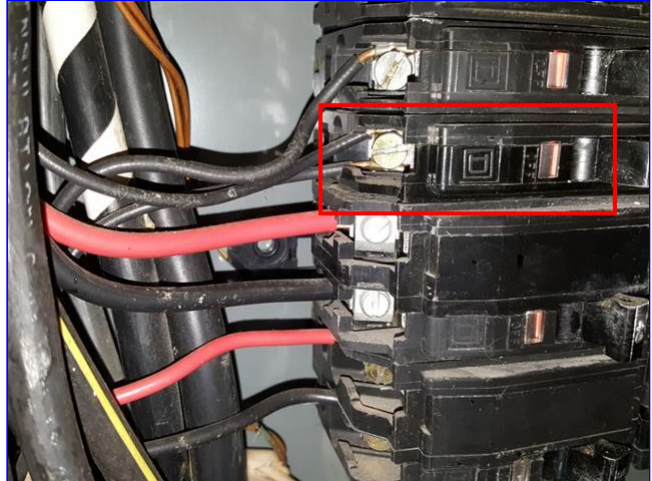

9.3 Item 3(Picture)

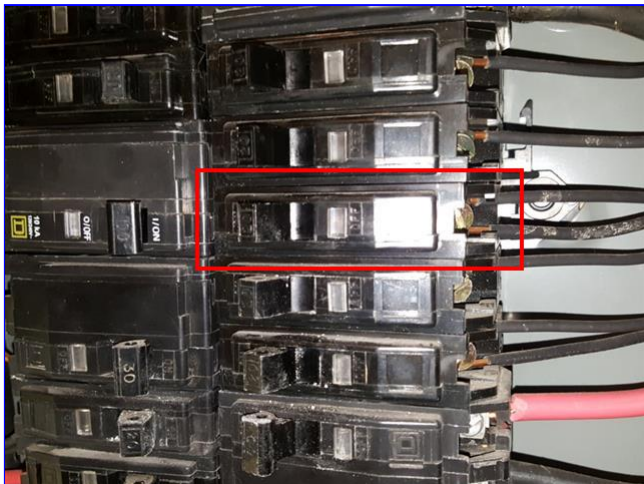

9.3 Item 4(Picture)

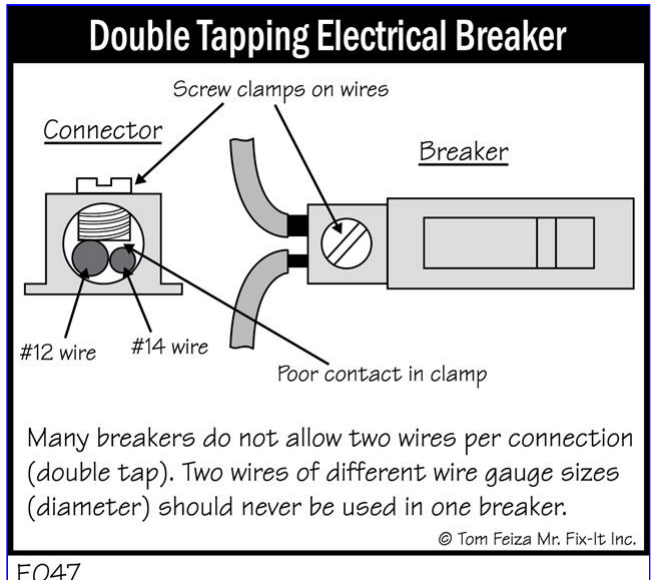

EO47  
9.3 Item 5(Picture)

(5) Some of the breakers are not manufactured by the maker of the sub panel. Most mismatched breakers are normally not allowed because the connections may be loose or tight which can result in an electrical fire or short. This is a potential safety hazard. Recommend a qualified electrician verify that these breakers are compatible with this panel prior to closing.

## 9. Electrical System

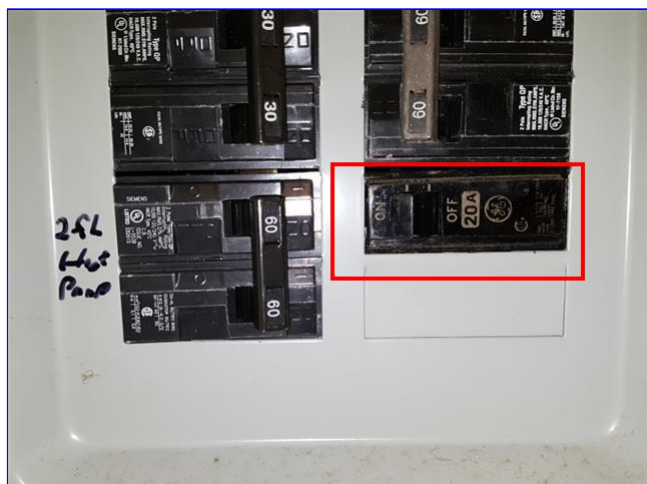

9.3 Item 7(Picture)

(6) Wires that are not in use or connected to a breaker in the panel box should have a twist cap to protect the wire from possibly being energized if it comes in contact with current. If not corrected this could lead to a possible short creating a fire or it may energize the panel box creating an electrical shock when the box is touched. This is a serious safety issue. Recommend a qualified electrician repair as needed and further inspect panel to determine any other additional issues that could not be found within the panel box for your safety.

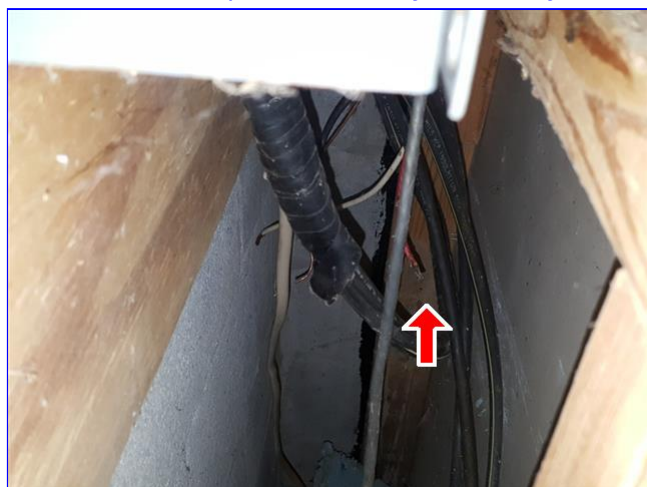

9.3 Item 8(Picture)

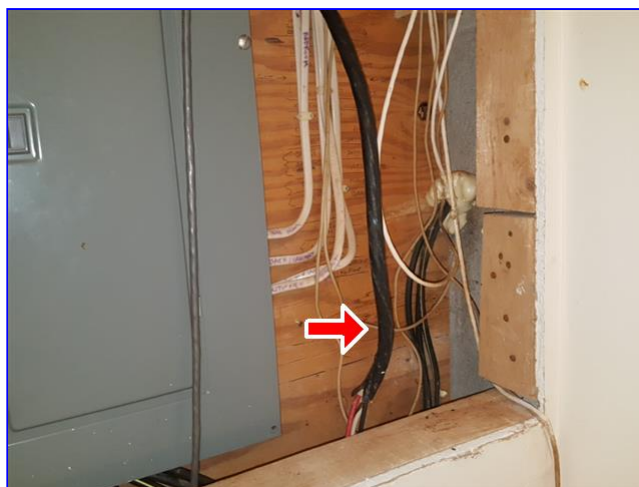

9.3 Item 9(Picture)

## 10(A). Heating / Central Air Conditioning Unit 1 Lower Level



### 10.13.A General Notes

#### Inspected

(1) During inspection it was noted that the home was not being cooled as intended. Upon arrival the temperature within the home was 76degrees. The thermostat was set to 72 degrees and took nearly 4 hours to reach the desired setting within the home before the unit turned off. This indicates that the unit is not running efficiently. This could be caused by a number of conditions, some could be costly. This condition can increase cooling and heating costs and add wear and tear on the HVAC unit within the home. Recommend a qualified licensed HVAC contractor further inspect and evaluate heat pump for proper operation before closing.



**10(B). Heating / Central Air Conditioning Unit 2 Upper Level****10.0.B Heating / Cooling Equipment****Repair or Replace**

(3) Water was found in the condensate drain pan under the air handler in the attic. This water may be leaking from the evaporative coil or maybe caused by condensation from the large suction line leading into the unit. **Strongly** recommend a qualified HVAC contractor further investigate for cause and make any needed repairs that may be necessary prior to closing. Also recommend the Aqua guard condensate shut off switch be checked to see if it is working as the unit remained on during the inspection.



10.0.B Item 2(Picture)

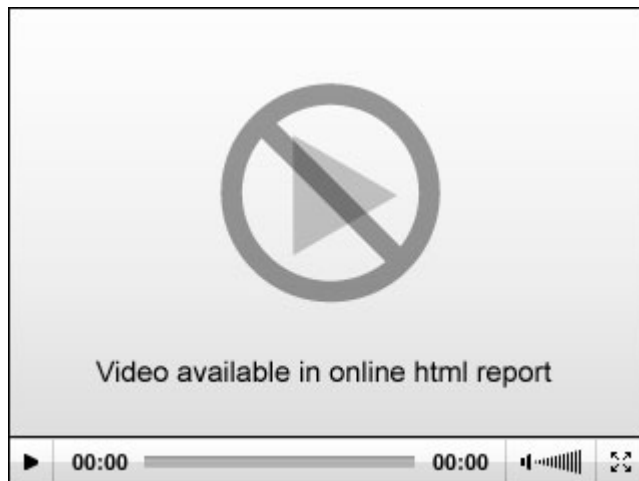

10.0.B Item 3(Video)

**10.2.B Electrical (heating and cooling systems)****Repair or Replace**

(2) The disconnect for the Heat Pump at the right side of the home is missing a cover inside the box to protect the wiring. This is a safety issue especially due to no lock on the box cover. The wires are exposed. A child or person can be shocked if wires are tampered with which may result in a death or injury. Recommend a qualified electrician correct and repair for safety.

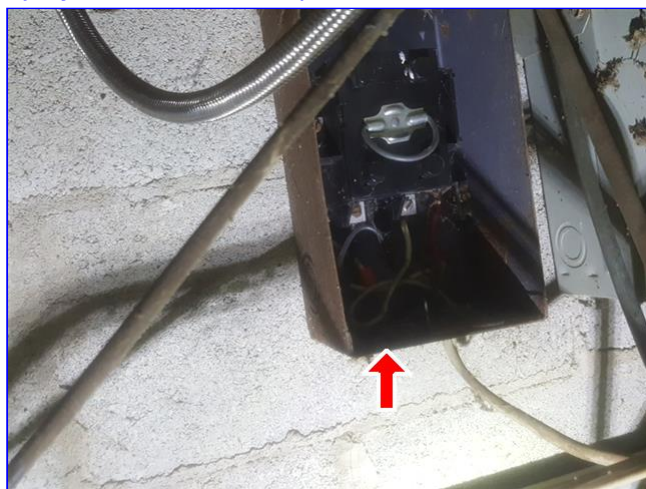

10.2.B Item 2(Picture)

(3) The aqua guard safety switch does not appear to be working. Water was in the tray and the switch was in contact with the water, yet the unit remained on. Recommend a qualified HVAC contractor repair or replace as needed to prevent a water leak occurring in the attic which will damage ceiling and insulation in the attic. **Also refer to note 10.0.B(3).**



**10(B). Heating / Central Air Conditioning Unit 2 Upper Level**

10.2.B Item 3(Picture)

---

Home inspectors are not required to report on the following: Life expectancy of any component or system; The causes of the need for a repair; The methods, materials, and costs of corrections; The suitability of the property for any specialized use; Compliance or non-compliance with codes, ordinances, statutes, regulatory requirements or restrictions; The market value of the property or its marketability; The advisability or inadvisability of purchase of the property; Any component or system that was not observed; The presence or absence of pests such as wood damaging organisms, rodents, or insects; or Cosmetic items, underground items, or items not permanently installed. Home inspectors are not required to: Offer warranties or guarantees of any kind; Calculate the strength, adequacy, or efficiency of any system or component; Enter any area or perform any procedure that may damage the property or its components or be dangerous to the home inspector or other persons; Operate any system or component that is shut down or otherwise inoperable; Operate any system or component that does not respond to normal operating controls; Disturb insulation, move personal items, panels, furniture, equipment, plant life, soil, snow, ice, or debris that obstructs access or visibility; Determine the presence or absence of any suspected adverse environmental condition or hazardous substance, including but not limited to mold, toxins, carcinogens, noise, contaminants in the building or in soil, water, and air; Determine the effectiveness of any system installed to control or remove suspected hazardous substances; Predict future condition, including but not limited to failure of components; Since this report is provided for the specific benefit of the customer(s), secondary readers of this information should hire a licensed inspector to perform an inspection to meet their specific needs and to obtain current information concerning this property.

Prepared Using HomeGauge <http://www.HomeGauge.com> : Licensed To Giancarlo Barone

# Conditional General Summary



**TALON**  
Home Inspections

**Talon Home Inspections, LLC**

**4101 Tates Creek Centre Drive  
Suite 150 - PMB 312  
Lexington, KY, 40517  
(859) 447 0050**

**Customer**

Mrs. Gail Schneider

**Address**

780 Nutfield Way  
Richmond KY 40475

The following items or discoveries indicate that these systems or components **appeared to be functioning as intended, but is in need of minor repair or correcting to prevent possible issues that can effect the building.** This summary shall not contain recommendations for routine upkeep of a system or component to keep it in proper functioning condition or recommendations to upgrade or enhance the function or efficiency of the home. This Summary is not the entire report. The complete report may include additional information of concern to the customer. It is recommended that the customer read the complete report.

## **2. Roofing / Chimneys / Roof Structure and Attic**



### **2.4 Roof Drainage Systems (drip edge, gutters, downspouts, and splashblocks)**

#### **Repair or Replace**

(1) The gutters where indicated in photos have mounting bolts that are loose at the left side of the home. If not corrected gutters can become detached from the fascia and also water can enter the soffits which can lead to wood rot. Recommend a qualified contractor repair loose gutters to avoid spilling roof runoff around perimeter of home.

**2. Roofing / Chimneys / Roof Structure and Attic**

2.4 Item 1(Picture)

(2) Recommend the downspout extension(s) be attached to the downspout at the front right corner of the home by placing a screw at the top and bottom where it connects to the downspout to ensure the extension(s) does not pull away from the downspout(s). Failing to do this may create future problems to the foundation around the home due to soil erosion and water entering the basement which may result in the foundation settlement if the extension detaches from the downspout.



2.4 Item 2(Picture)

**2.5 Attic Access****Repair or Replace**

(2) Recommend repairing the hole in the pull down ladder door.

## 2. Roofing / Chimneys / Roof Structure and Attic

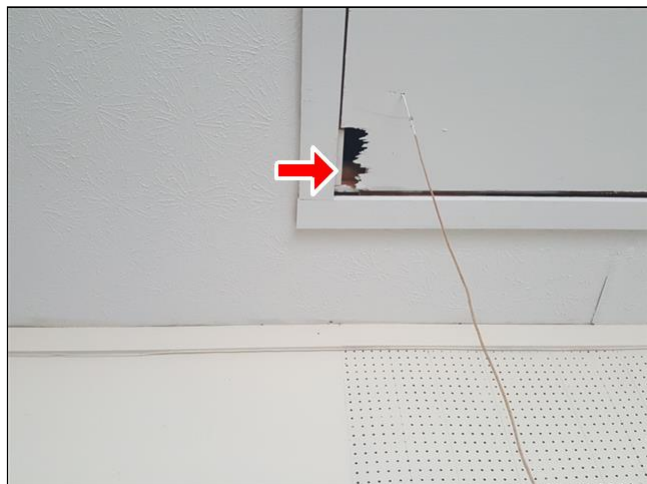

2.5 Item 4(Picture)

## 3. Exterior



### 3.0 Masonry Siding and Trim

#### Conditional

Typical stair step cracks at the mortar joint in the brick siding at the right side of the home above the garage was observed. These cracks imply that the lintel may be rusting or expanding. A lintel is a metal beam supporting the masonry above an opening in a wall. It also may imply that minor settlement of the home has occurred. While the rate of movement cannot be predicted during a one-time inspection it is likely that repairs are needed. These cracks do not appear significant at this stage from a structural concern due to the width of the crack. Due to freeze/thaw (water entering), the cracks should be sealed to minimize further chipping away, flaking or deterioration. The lintel is covered. Recommend these cracks be sealed to prevent further cracking and possible deterioration of the brick work. A skilled masonry contractor should perform the repairs via re-pointing mortar. It is recommended that you monitor periodically and if cracks reappear further investigation by a structural engineer is recommend. Ensure the lintel is sealed so that water intrusion does not occur to prevent rusting of the lintel.



### 3. Exterior



3.0 Item 1(Picture) right side of garage

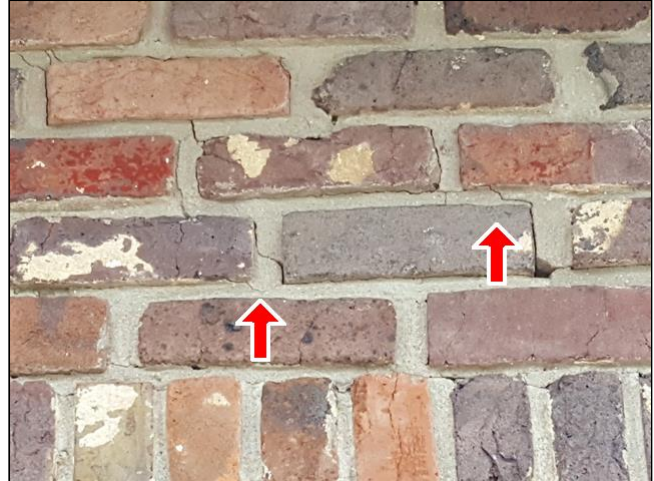

3.0 Item 2(Picture) right side

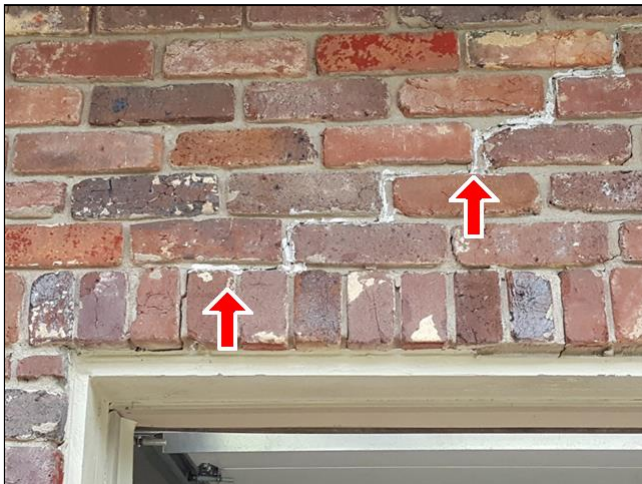

3.0 Item 3(Picture) left side

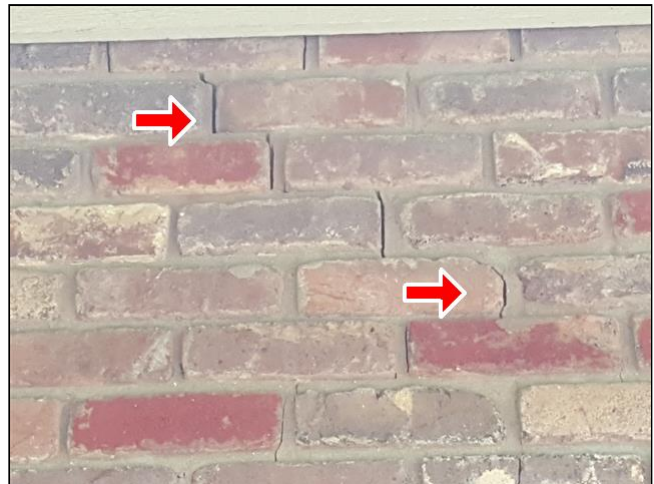

3.0 Item 4(Picture) left side

#### 3.1 Wood Siding and Trim

##### Repair or Replace

(1) There is evidence of recent carpenter bee damage to the wood siding in some areas of the home. Carpenter bees have the ability to tunnel into the wood which can compromise the structure and cause damage via water intrusion. Recommend sealing holes where found around the perimeter of the home with the appropriate sealer, then consult a pest control specialist for advice on a possible treatment to prevent further damage and deterioration of the wood siding around the home.

[Carpenter Bee Treatment and Repair](#)

### 3. Exterior



3.1 Item 1(Picture)

#### 3.4 Windows

##### Conditional

(1) The gaps between the window frames and the siding around the home need to be sealed correctly to prevent water intrusion. Water entering here can lead to deterioration of the wall siding and potential leaks inside the wall cavity. Recommend caulking these areas with a quality moisture resistant caulk that expands and contracts. [Choosing the right caulk](#)



3.4 Item 1(Picture)



3.4 Item 2(Picture)

(2) The window frame at the rear right side of the home has cracked sealant between the siding and the window frame. Water and/or insects may enter and deterioration may occur behind the wall cavity and siding. This is a small repair. Recommend re-caulking as needed. [Which caulk to use](#)



### 3. Exterior



3.4 Item 3(Picture)

### 3.5 Porches, Balconies, Areaways, Stoops, Steps, and Applicable Railings

#### Repair or Replace

(4) The staircase at the front porch has sunken on the left side. The staircase may be in contact with the ground. This may become a possible safety issue if further settlement occurs. Recommend replacement or repair as needed by a qualified contractor.



3.5 Item 6(Picture)

### 3.6 Decks, Structure, Railings, Stairs

#### Repair or Replace

(6) The bottom of the deck steps are in contact with the soil at the rear right side of the home. The stairs need to be resting on a concrete landing. Over time the soil will erode away and weaken the bottom of the staircase and will not be supported. In the future this will result in being a safety issue and an injury could occur. Recommend correcting as needed by a general contractor or qualified person.

### 3. Exterior



3.6 Item 10(Picture)

#### 3.7 Driveways, Walkways (With respect to their effect on the condition of the building)

##### Conditional

Common settlement crack(s) were noted at the concrete drive. This is not a tripping hazard as yet at this time. I also do not see these small cracks as an indication of a structural issue. Further deterioration and/or settlement can occur to the driveway via water intrusion if not repaired. Recommend repairs via a masonry caulk as needed then monitor annually. Here is a link for [Sealing Concrete Cracks](#)



3.7 Item 1(Picture)

#### 3.11 Vegetation, (With respect to their effect on the condition of the building)

##### Conditional

(2) There are tree branches that overhang over the roof at the front right corner of the home. Be observant. Tree limbs should be cut as needed to prevent damage to the shingles and from scraping on the roof surface. They will also clog gutters which will cause water run off problems around the home. Recommend cutting back tree branches as needed.



### 3. Exterior



3.11 Item 1(Picture)

#### 3.14 General Comments

##### Inspected

(2) Common settlement crack(s) were noted at the patio floor near the pool area. This has caused a slope which allows water to pool and not drain correctly. Water pooling here can lead to the retaining wall to settle or lean in the future. Recommend a qualified masonry contractor repair as needed. Consideration for improving drainage in this area is also recommended. Further deterioration and/or settlement can occur to the concrete floor via water intrusion if not repaired.



3.14 Item 4(Picture)

### 5(A). Kitchen / Components and Appliances Main Kitchen



#### 5.9.A Counters and a representative number of Cabinets

##### Conditional

Recommend caulking around the counter top in the kitchen to seal the gap/crack in front of the sink. Water may enter which can cause damage to the drywall and cabinets, then result in possible mold forming. Repair using a quality caulk that is resistant to moisture and is expandable. Here is a link on [How to Choose the right Caulk](#)

**5(A). Kitchen / Components and Appliances Main Kitchen**

5.9.A Item 1(Picture)

**5.11.A Clothes Dryer Vent Piping****Conditional**

(2) The dryer vent piping is damaged. This can cause an obstruction of lint that has a possibility to create a fire hazard. Recommend replacing flexible line prior to using dryer.

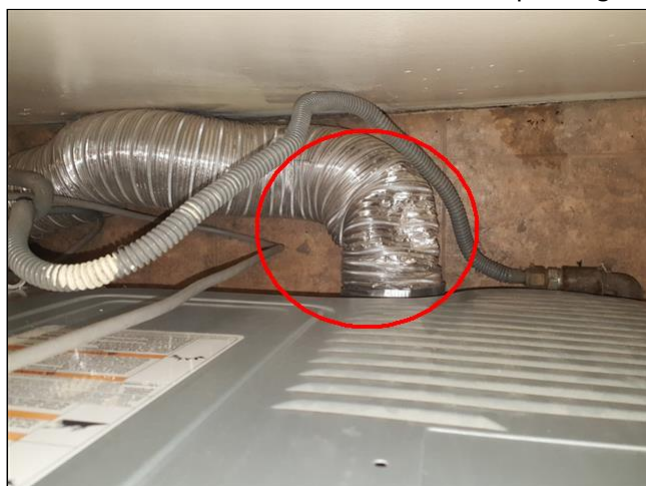

5.11.A Item 2(Picture)

**6. Rooms****6.7 Outlets, GFCI, Wall Switches and Fixtures (Lights and Ceiling Fans)****Repair or Replace**

(1) It is not recommended that these adapters be used in the outlets as they can overheat and cause a fire. This is for your safety. Especially in areas like kitchens where numerous appliances can be connected. If additional outlets are required, recommend a qualified electrician install them as needed.

## 6. Rooms



6.7 Item 1(Picture) living room

### Receptacles – Don't Overload

© Tom Feiza Mr. Fix-It Inc.

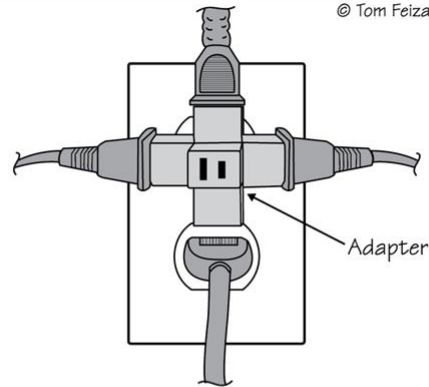

Do not use adapters that allow multiple cords into one outlet. You may overload the outlet/circuit. They often have no ground, resulting in poor connections, excessive heat – posing a fire hazard!

E087

6.7 Item 2(Picture)

## 7. Bathroom and Components



### 7.1 Counters and Cabinets

#### Conditional

Recommend caulking around the counter top in the guest bathroom to seal the gap/crack. Water may enter which can cause damage to the drywall and cabinets, then result in possible mold forming.

Repair using a quality caulk that is resistant to moisture and is expandable. Here is a link on [How to Choose the right Caulk](#)



7.1 Item 1(Picture)

### 7.2 Doors (Representative number)

#### Conditional

The entry door in the basement bathroom where indicated in the photo does close properly, however it rubs at the door jamb when closing where indicated in photos. This is a maintenance issue and is for your information. Sometimes correcting the door opening can require the door trim to be removed

## 7. Bathroom and Components



then touch up painting or doors will need to be rehung or trimmed down. Recommend a qualified contractor repair as needed.



7.2 Item 1(Picture)

### 7.7 Bath(s) and/or Shower(s) - walls,enclosure, and doors

#### Conditional

(2) Recommend a quality caulk that is expandable and moisture resistant along the top of the threshold of the bath tub so moisture or water cannot penetrate in the master bathroom. [Choosing the right caulk](#)



7.7 Item 2(Picture)

## 8. Plumbing System



### 8.2 Hot Water Systems and Controls

#### Repair or Replace

(4) The drain pan installed under the water heater in the upstairs closet is missing a drain line to the exterior. If the water heater leaks it has the potential to cause severe damage if a leak should develop which will result in costly repairs to the floor and ceiling below if a drain line is not connected. As an inexpensive safe-guard a drain pan with a moisture alarm can easily be installed as



## 8. Plumbing System



another option. Recommend a qualified plumber install a drain line at the pan that leads to the exterior of home.



8.2 Item 2(Picture)

(9) Unprotected electrical wiring leading into the water heater in the basement is susceptible to being damaged and should be covered or protected by a rigid conduit. This is a potential safety issue. This will protect the wire jacket from possible melting if it comes in contact with the hot water line which could energize the unit and cause an electric shock if any water or metal surface is touched. Recommend a qualified electrician install a conduit to make the connection safer and protect the wire from being damaged.



8.2 Item 8(Picture)

## 9. Electrical System



### 9.3 Branch Circuit Conductors, Overcurrent Devices and Compatibility of their Amperage and Voltage

#### Repair or Replace

(4) The white wire(s) that are connected to the circuit breaker(s) in the main panel should be marked black to indicate that they are live (hot wires) and are being used for the flow of electricity to travel. Recommend an electrician correct due to safety.

## 9. Electrical System

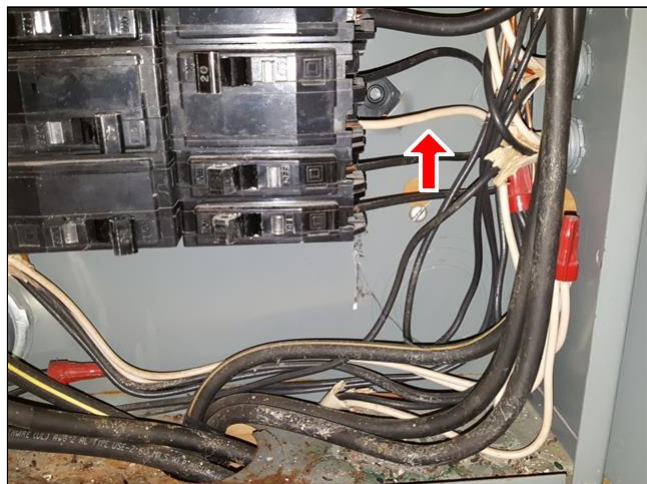

9.3 Item 6(Picture)

## 10(A). Heating / Central Air Conditioning Unit 1 Lower Level



### 10.0.A Heating / Cooling Equipment

#### Inspected

(2) The heat pump should be raised of the ground for better efficiency and proper drainage. Blocked fins via snow coverage can harm the unit and increase energy costs. Recommend a qualified HVAC contractor correct if desired. Ensure when a new unit is installed that this is done on new installation.



10.0.A Item 1(Picture)

### 10.1.A Filter Location/Condition

#### Conditional

(2) The door to access the filter next to the Gas Furnace is missing in the basement. This can allow dirt and debris to bypass the filter. The filter ensures clean air is distributed within the home and also protects the equipment from small debris entering which can lead to problems with the unit and duct work. Recommend replacement/correcting as needed by a qualified HVAC contractor.

**10(B). Heating / Central Air Conditioning Unit 2 Upper Level****10.2.B Electrical (heating and cooling systems)****Repair or Replace**

(1) The exterior electrical box for the Heat Pump is rusted on the outside and on the inside. Recommend it be painted or replaced to prevent further rusting. If replaced a qualified electrician should perform replacement.

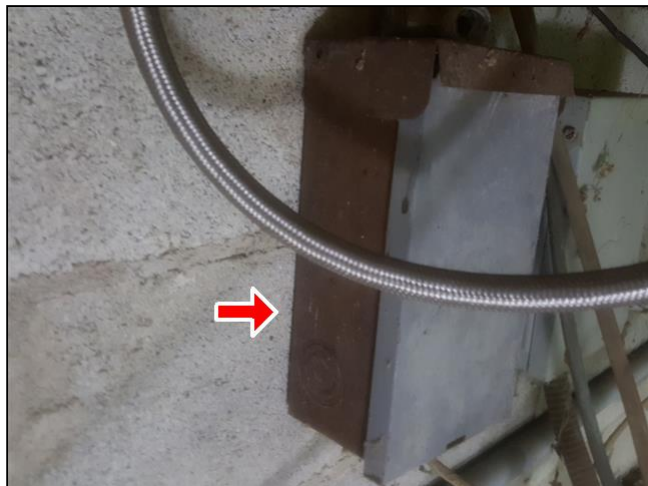

10.2.B Item 1(Picture)

---

Prepared Using HomeGauge <http://www.HomeGauge.com> : Licensed To Giancarlo Barone



**TALON**  
Home Inspections

**INVOICE**

**Talon Home Inspections, LLC**  
**4101 Tates Creek Centre Drive**  
**Suite 150 - PMB 312**  
**Lexington, KY, 40517**  
**(859) 447 0050**  
**Inspected By: Giancarlo Barone**

**Inspection Date: 7/15/2018**  
**Report ID: 180715BETHAM**

<b>Customer Info:</b>	<b>Inspection Property:</b>
Mrs. Gail Schneider 780 Nutfield Way Richmond KY 40475	780 Nutfield Way Richmond KY 40475
<b>Customer's Real Estate Professional:</b>	

**Inspection Fee:**

<b>Service</b>	<b>Price</b>	<b>Amount</b>	<b>Sub-Total</b>
Sq Ft 5,001 -5500	600.00	1	600.00
Crawlspace / Basement	40.00	1	40.00
Over 30 Years Old	35.00	1	35.00
			<b>Tax \$0.00</b>
			<b>Total Price \$675.00</b>

**Payment Method:** Money Order  
**Payment Status:** Paid At Time Of Inspection  
**Note:**





**Talon Home Inspections, LLC**

**Giancarlo Barone**

**4101 Tates Creek Centre Drive  
Suite 150 - PMB 312  
Lexington, KY, 40517  
(859) 447 0050**

