

Canadian Suggested Retail Price List in USD
Jan-19

Phone: 260-665-2769

Fax: 260-665-3047

Email: iim@mobility-usa.com

www.mobility-usa.com

Quote: _____

P.O. _____

Bill To:

Dealer: _____ Contact: _____

Address: _____

City: _____ State: _____ Zip: _____

Phone: _____ Fax: _____

Email: _____ Mark For: _____

Ship To:

Same as Bill To: _____

Dealer: _____ Contact: _____

Address: _____

City: _____ State: _____ Zip: _____

Phone: _____ Fax: _____

Email: _____ Mark For: _____

Clip Features and Specifications

- **Frame** - lightweight aluminum, silver painted with non-toxic epoxy powders, chair folds similar to an umbrella
- **Backrest** - semi-rigid, reclines in three positions with zippers
- **Seat Bottom** - slightly inclined, semi-rigid
- **Blue & White Upholstery** - removable for washing with removable aluminium reinforcement ribs, slots for attaching accessories
- **Wheels** - puncture-proof wheels glide on ball bearings: 6" front wheels swivel, 8" rear wheels with independent brakes
- **Net basket** - on the back of the backrest
- **Footrest** - removable, height adjustable

Clip Seat - White & Blue Upholstery

Part Number	Description	Price (USD)	HCPCS
_____ CLP-1	Clip size 1	\$2,200.00	E1236
_____ CLP-2	Clip size 2	\$2,300.00	E1236



Footrest Options

Part Number	Description	Price (USD)	HCPCS
_____ 827	Foot Straps 8"-11"	\$70.00	E0951
_____ 827A	Foot Straps 11"-14"	\$80.00	E0951



_____ CLP817-1	Leg Straps size 1,2	\$135.00	K0038
----------------	---------------------	----------	-------







Client:





PO:

Clip USD

Positioning Options

Part Number	Description	Price (USD)	HCPCS	
CLP816-1	Side Supports for the trunk <small>size 1,2</small>	\$150.00	E0965	
CLP853-1	Vest Harness <small>size 1,2</small>	\$175.00	E0960	
894-1	45° Pelvic Belt <small>size 1,2</small>	\$95.00	E0978	
906-1	Five Point Harness <small>size 1,2</small>	\$130.00	E0960	
CLP835-1	Adjustable Headrest <small>size 1,2</small>	\$150.00	E0955	

Clip Accessories

Part Number	Description	Price (USD)	HCPCS	
CLP812-1	Wheel direction locks <small>size 1,2,3</small>	\$175.00	K0108	
CLP818-1	Blue Thermal Cover <small>size 1,2</small>	\$375.00	K0108	
CLP819-1	Blue Canopy <small>size 1,2 requires CLP819-HW</small>	\$300.00	K0108	
CLP819-HW	Canopy Hardware	\$125.00	K0108	
CLP 825-1	Blue Rain Cover <small>size 1,2 requires 819</small>	\$150.00	K0108	
891	Tie Down Hooks Set of 4-forward-facing transport conforms with ISO 7176/19 and ANSI RESNA WC/19	\$275.00	K0108	

Client:

PO:

Clip USD

Client Measurements

A Back height _____ F Lower leg length _____
 B Chest depth _____ G Head height _____
 C Chest width _____ H Arm height _____
 D Seat depth _____ Age: _____
 E Seat width _____ Weight: _____

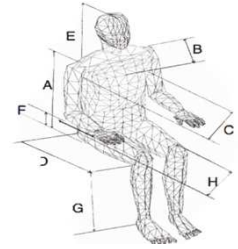

Dimensions

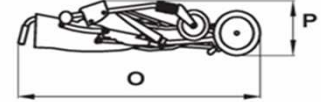
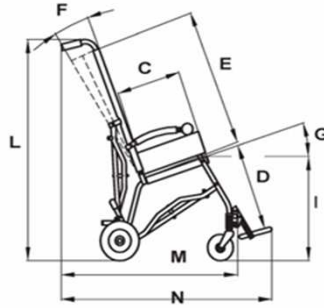
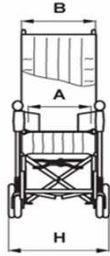

Measurement in Inches

Clip	Size 1	Size 2
Max Capacity	66 lbs	77 lbs
User Height	43 - 49	47 - 55
Unit Weight	24 lbs	24 lbs
A Seat width	12	13
B Back width	16	16
C Seat depth	10	12
D Legrest length	6 - 9	8 - 12
E Backrest height	21.5	23
F Backrest inclination	0° - 12°	0° - 12°
G Seat bottom inclination-tilt	18°	18°
H Total width	20	20
I Knee to floor	18	19
L Height of chair	39	39
M Front wheel to handle bar	29	29
N Total length	31.5	35
O Folded seat height	43	43
P Folded seat depth	12	12
Q Folded seat width	12.5	12.5

Note: All specification and prices are subject to change without notice. Prices listed are only valid if ordering with a stroller. The HCPCS codes provided are not intended to be billing or legal advice, rather Innovation In Motion's interpretation of the code definitions. Use of the codes provided does not ensure coverage or payment for the item. For coverage information, verify the policy of the appropriate payer. It is recommended to contact Innovation In Motion with any questions regarding proper ordering of the chair at 1-260-665-2769.