

24 BAKER ST, P.O. BOX 100, HASTINGS DN, KOL - 1Y0  
 705-696-2383, 1-800-465-3433, FAX 705-696-1922

**17'X30' R.H. PALETTE**

QTY.	LENGTH	RADIUS	TYPE
1	8'0"	24'0"	PLAIN
1	8'0"	24'0"	SKIMMER
1	7'6"	24'0"	PLAIN
2	8'0"	8'0"	PLAIN
1	8'0"	8'0"	RETURN
1	6'0"	8'0"	PLAIN
1	7'0"	7'0"	PLAIN
1	4'0"	4'0"	REVERSE
2	3'2"	4'0"	REVERSE
2	3'2"	2'0"	CORNER
1	6'0"	NA	RETURN
1	4'0"	NA	PLAIN
15	-	NA	A-FRAME
1	-	NA	N&B PKG
			S.A. 407 sq.ft.
			PER: 87'2"
1731PALC			DATE: 12-04-00

STAKE OUT			
A-C	12'4-1/2"	B-C	10'7-3/8"
A-D	17'-1/2"	B-D	11'5"
A-E	16'5-1/4"	B-E	9'1-3/8"
A-F	21'6-1/4"	B-F	23'2"
A-G	25'11-1/2"	B-G	22'8"
A-H	27'5-3/8"	B-H	21'9"
A-I	26'4-5/8"	B-I	18'8-1/4"
A-J	23'9"	B-J	14'8-3/4"
A-K	21'2-3/4"	B-K	11'11-3/4"
A-L	19'1-3/4"	B-L	20'7-7/8"
A-M	10'9"	B-M	13'3"

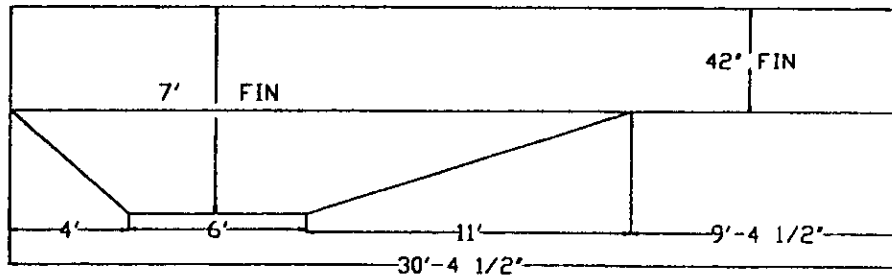
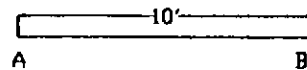

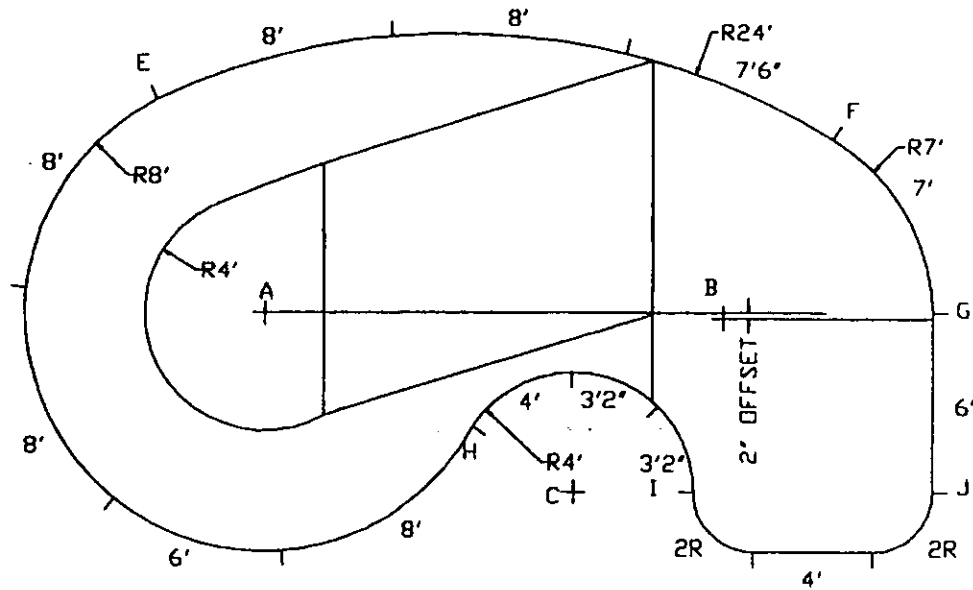
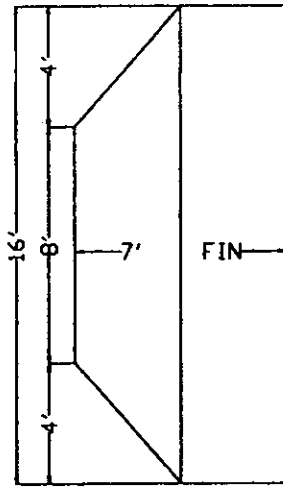

24 BAKER ST. P.O. BOX 100, HASTINGS ON KOL - 1Y0  
 705-696-2385, 1-800-465-3433, FAX: 705-696-1922

**17'X30' R.H. PALETTE**

QTY.	LENGTH	RADIUS	TYPE
1	8'0"	24'0"	PLAIN
1	8'0"	24'0"	SKINNER
1	7'6"	24'0"	PLAIN
2	8'0"	8'0"	PLAIN
1	8'0"	8'0"	RETURN
1	6'0"	8'0"	PLAIN
1	7'0"	7'0"	PLAIN
1	4'0"	4'0"	REVERSE
2	3'2"	4'0"	REVERSE
2	3'2"	2'0"	CORNER
1	6'0"	NA	RETURN
1	4'0"	NA	PLAIN
15	-	NA	A-FRAME
1	-	NA	N&B PKG
			S.A.: 407 sq.ft.
			PER: 87'2"
1731PALC			DATE: 12-04-00

STAKE OUT			
A-B	15'4-1/2"	I-E	22'3"
A-C	11'11-7/8"	I-F	12'8-1/4"
A-D	16'-1/8"	I-G	10'
B-C	7'8-1/4"	I-H	7'8"
B-D	17'	I-J	8'
B-G	7'		

D+

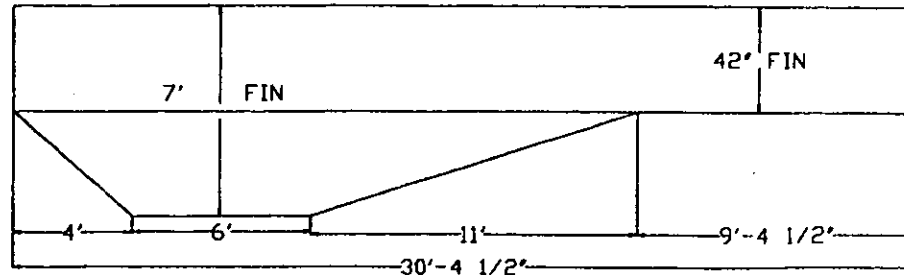

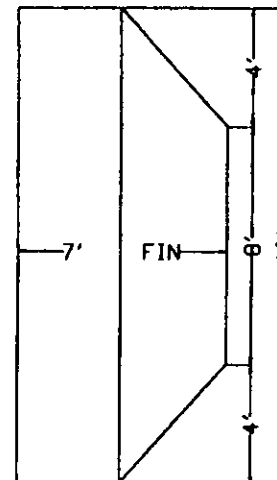
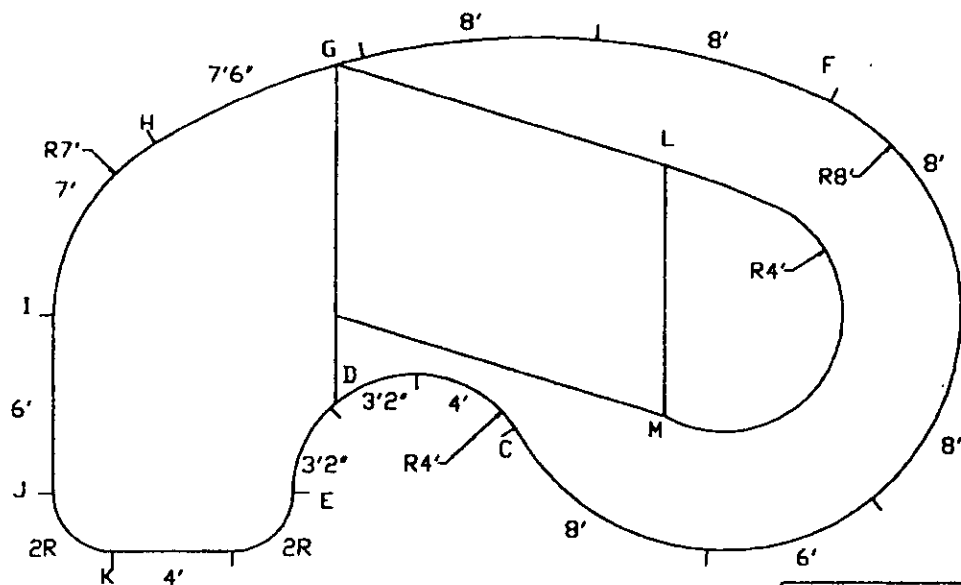

STAKE OUT			
A-C	12'-4-1/2"	B-C	10'-7-3/8"
A-D	17'-1/2"	B-D	11'-5"
A-E	16'-5-1/4"	B-E	9'-1-3/8"
A-F	21'-6-1/4"	B-F	25'-2"
A-G	25'-11-1/2"	B-G	22'-8"
A-H	27'-5-3/8"	B-H	21'-9"
A-I	26'-4-5/8"	B-I	18'-8-1/4"
A-J	23'-9"	B-J	14'-8-3/4"
A-K	21'-2-3/4"	B-K	11'-11-3/4"
A-L	19'-1-3/4"	B-L	20'-7-7/8"
A-M	10'-9"	B-M	13'-3"

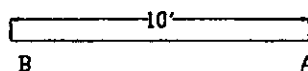

24 BAKER ST. P.O. BOX 100 HASTINGS ON KOL-1Y0  
 705-696-2385, 1-800-465-3433, FAX 705-696-1922

### 17'X30' L.H. PALETTE

QTY.	LENGTH	RADIUS	TYPE
1	8'0"	24'0"	PLAIN
1	8'0"	24'0"	SKIMMER
1	7'6"	24'0"	PLAIN
2	8'0"	8'0"	PLAIN
1	8'0"	8'0"	RETURN
1	6'0"	8'0"	PLAIN
1	7'0"	7'0"	PLAIN
1	4'0"	4'0"	REVERSE
2	3'2"	4'0"	REVERSE
2	3'2"	2'0"	CORNER
1	6'0"	NA	RETURN
1	4'0"	NA	PLAIN
15	-	NA	A-FRAME
1	-	NA	N&B PKG
			S.A. 407 sq.ft.
			PER: 87'2"
1731PALC			DATE: 12-04-00

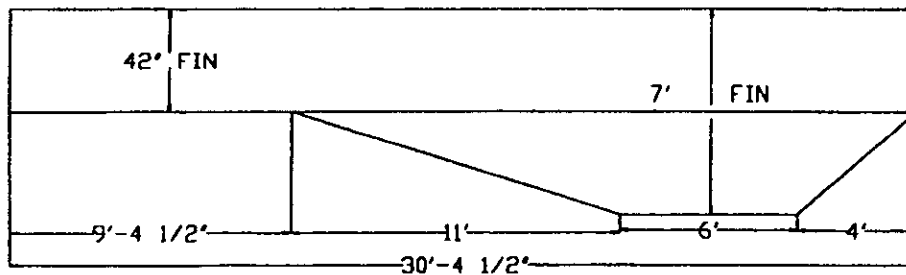

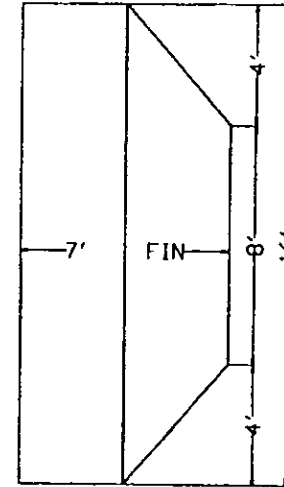
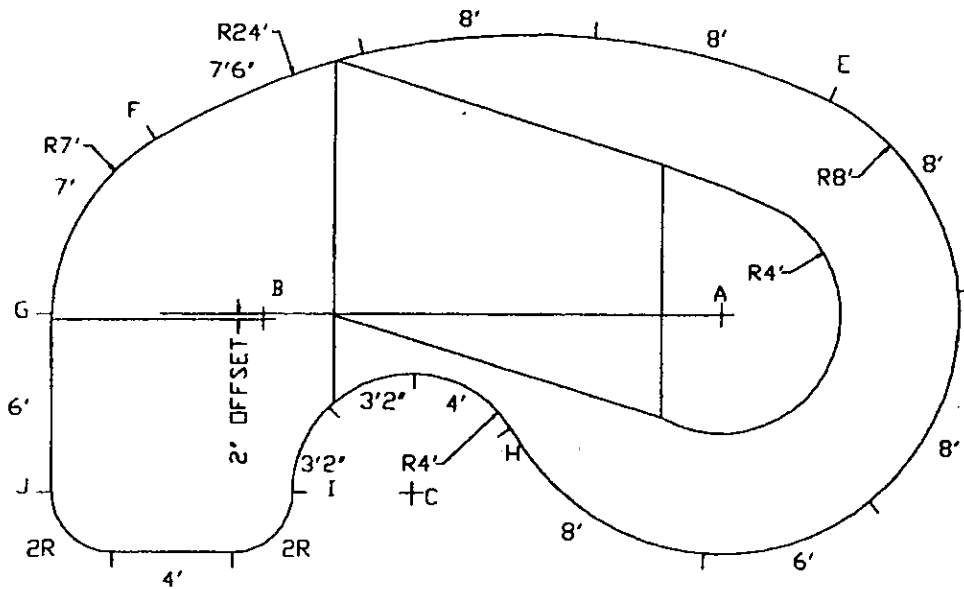

STAKE OUT			
A-B	15'-1/2"	I-E	22'-3"
A-C	11'-11-7/8"	I-F	12'-8-1/4"
A-D	16'-1/8"	I-G	10'
B-C	7'-8-1/4"	I-H	7'-8"
B-D	17'	I-J	8"
B-G	7'		

+D

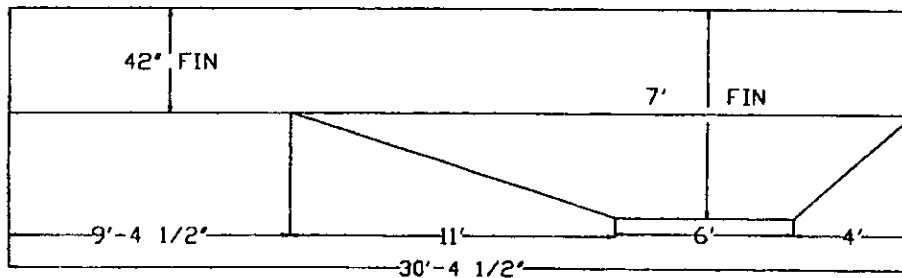

24 BAKER ST. P.O. BOX 100, HASTINGS DN. KOL-1Y0  
705-696-2385, 1-800-465-3433, FAX: 705-696-1922

### 17'X30' L.H. PALETTE

QTY.	LENGTH	RADIUS	TYPE
1	8'0"	24'0"	PLAIN
1	8'0"	24'0"	SKIMMER
1	7'6"	24'0"	PLAIN
2	8'0"	8'0"	PLAIN
1	8'0"	8'0"	RETURN
1	6'0"	8'0"	PLAIN
1	7'0"	7'0"	PLAIN
1	4'0"	4'0"	REVERSE
2	3'2"	4'0"	REVERSE
2	3'2"	2'0"	CORNER
1	6'0"	NA	RETURN
1	4'0"	NA	PLAIN
15	-	NA	A-FRAME
1	-	NA	N&B PKG
			S.A. 407 sq.ft.
			PER. 87'2"
1731PALC			DATE: 12-04-00

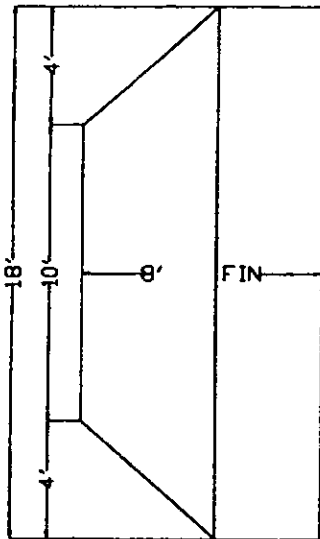

24 BAKER ST. P.O. BOX 100, HASTINGS ON KOL. 1Y0  
705-696-2383, 1-800-465-3433, FAX: 705-696-1922

**19'X34' R.H. PALETTE**

QTY.	LENGTH	RADIUS	TYPE
2	8'0"	24'0"	PLAIN
1	8'0"	24'0"	SKIMMER
1	4'0"	24'0"	PLAIN
3	8'0"	9'0"	PLAIN
1	8'0"	9'0"	RETURN
1	1'0"	9'0"	PLAIN
1	6'6"	7'0"	PLAIN
1	4'0"	4'0"	REVERSE
2	3'2"	4'0"	REVERSE
2	3'2"	2'0"	CORNER
1	7'0"	NA	RETURN
1	6'0"	NA	PLAIN
17	-	NA	A-FRAME
1	-	NA	N&B PKG
			S.A.: 527 sq.Ft.
			PER: 97'2"
1934PALC			DATE: 16-11-00

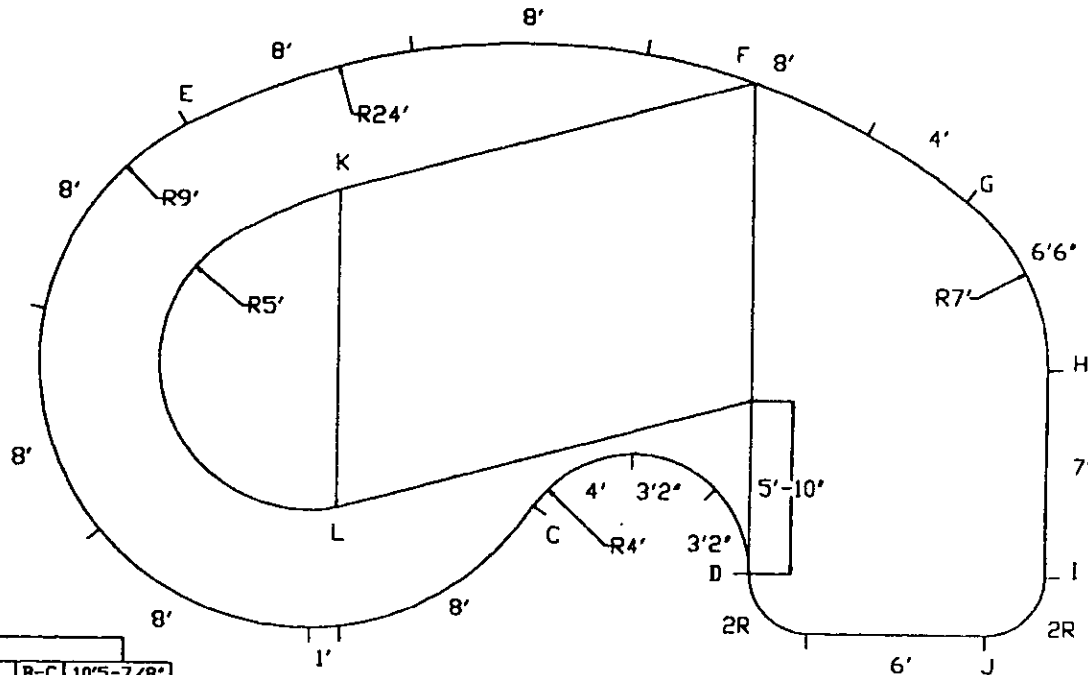

STAKE OUT			
A-C	12'9"	B-C	10'5-7/8"
A-D	16'11-3/4"	B-D	9'5"
A-E	23'4"	B-E	27'
A-F	28'9"	B-F	25'-1/2"
A-G	30'3"	B-G	23'11"
A-H	29'1-1/2"	B-H	21'2-1/4"
A-I	26'2-5/8"	B-I	16'11-3/4"
A-J	23'8-7/8"	B-J	14'3-1/2"
A-K	20'10-3/8"	B-K	22'8-5/8"
A-L	10'1-3/4"	B-L	13'6-1/2"
A-M		B-M	

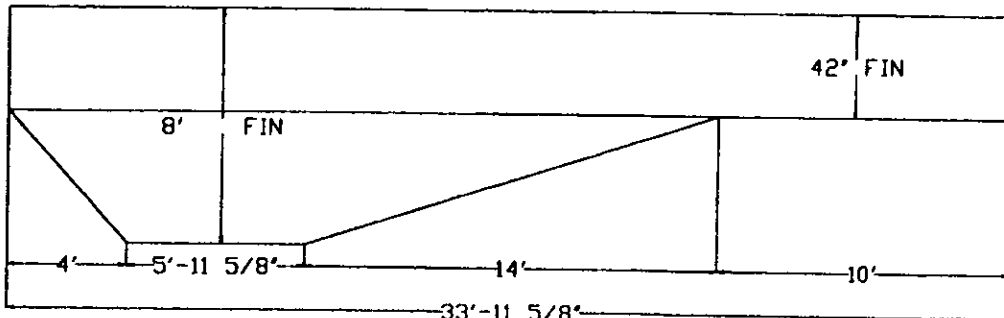
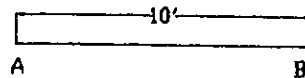

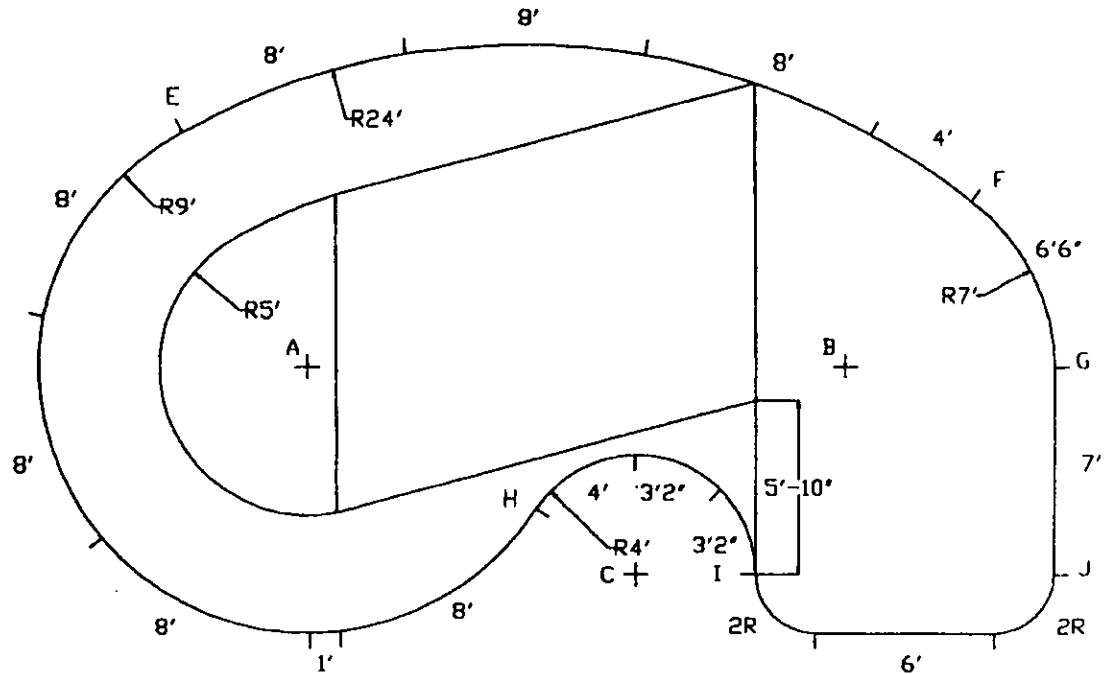
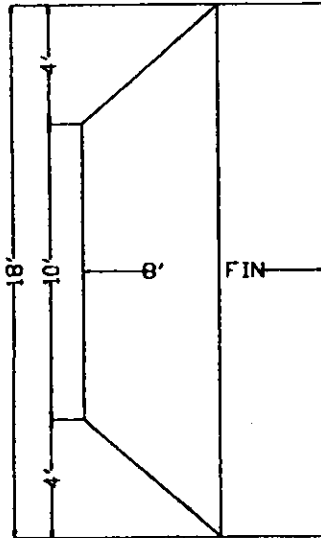

24 BAKER ST. P.O. BOX 100, HASTINGS ON KOL-1Y0  
705-696-2385, 1-800-465-3433, FAX: 705-696-1922

**19'X34' R.H. PALETTE**

QTY.	LENGTH	RADIUS	TYPE
2	8'0"	24'0"	PLAIN
1	8'0"	24'0"	SKINNER
1	4'0"	24'0"	PLAIN
3	8'0"	9'0"	PLAIN
1	8'0"	9'0"	RETURN
1	1'0"	9'0"	PLAIN
1	6'6"	7'0"	PLAIN
1	4'0"	4'0"	REVERSE
2	3'2"	4'0"	REVERSE
2	3'2"	2'0"	CORNER
1	7'0"	NA	RETURN
1	6'0"	NA	PLAIN
17	-	NA	A-FRAME
1	-	NA	N&B PKG
			S.A.: 527 sq.ft.
			PER: 97'2"
1934PALC			DATE: 16-11-00

STAKE OUT			
A-B	17'11-5/8"	I-E	24'3-3/4"
A-C	13'-1/8"	I-F	14'6-1/8"
A-D	15'	I-G	12'2-1/2"
B-C	9'10-3/4"	I-H	7'8-1/8"
B-D	17'	I-J	10'

D+

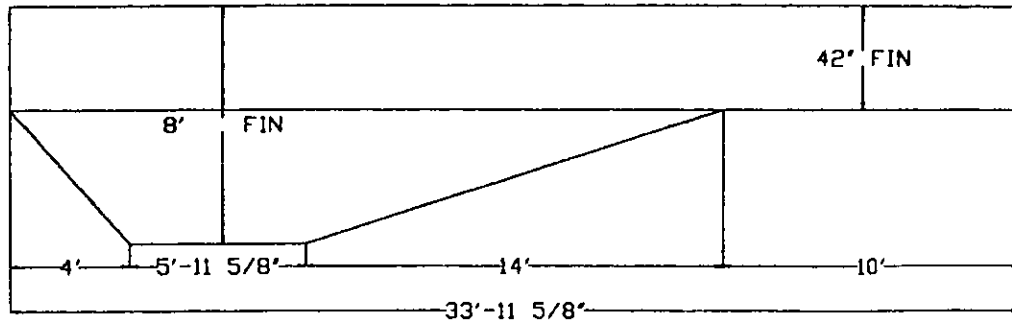

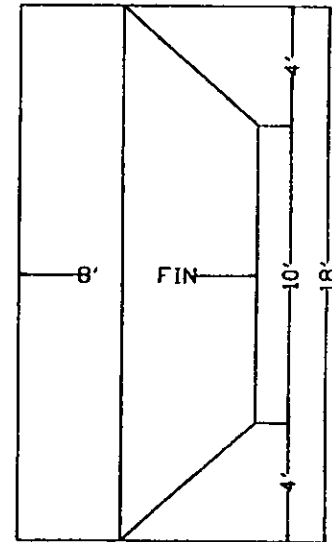
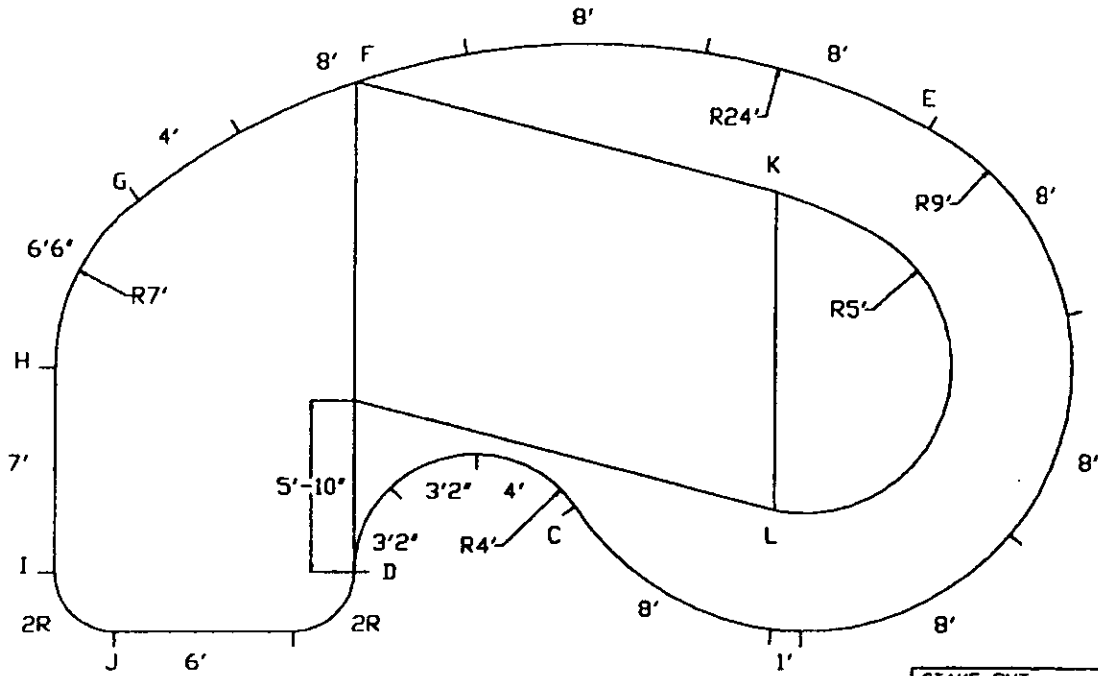

STAKE OUT			
A-C	12'9"	B-C	10'5-7/8"
A-D	16'11-3/4"	B-D	9'5"
A-E	23'4"	B-E	27'
A-F	28'9"	B-F	25'-1/2"
A-G	30'3"	B-G	23'11"
A-H	29'1-1/2"	B-H	21'2-1/4"
A-I	26'2-5/8"	B-I	16'11-3/4"
A-J	23'8-7/8"	B-J	14'3-1/2"
A-K	20'10-3/8"	B-K	22'8-5/8"
A-L	10'1-3/4"	B-L	13'6-1/2"
A-M		B-M	

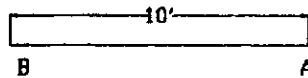

24 BAKER ST. P.O. BOX 100, HASTINGS ON KOL-1YQ  
 705-696-2385, 1-800-465-3433 FAX: 705-696-1922

19' X 34' L.H. PALETTE

QTY.	LENGTH	RADIUS	TYPE
2	8'0"	24'0"	PLAIN
1	8'0"	24'0"	SKIMMER
1	4'0"	24'0"	PLAIN
3	8'0"	9'0"	PLAIN
1	8'0"	9'0"	RETURN
1	1'0"	9'0"	PLAIN
1	6'6"	7'0"	PLAIN
1	4'0"	4'0"	REVERSE
2	3'2"	4'0"	REVERSE
2	3'2"	2'0"	CORNER
1	7'0"	NA	RETURN
1	6'0"	NA	PLAIN
17	-	NA	A-FRAME
1	-	NA	N&B PKG
			S.A: 527 sq.ft.
			PER: 97'2"
1934PALC			DATE: 16-11-00

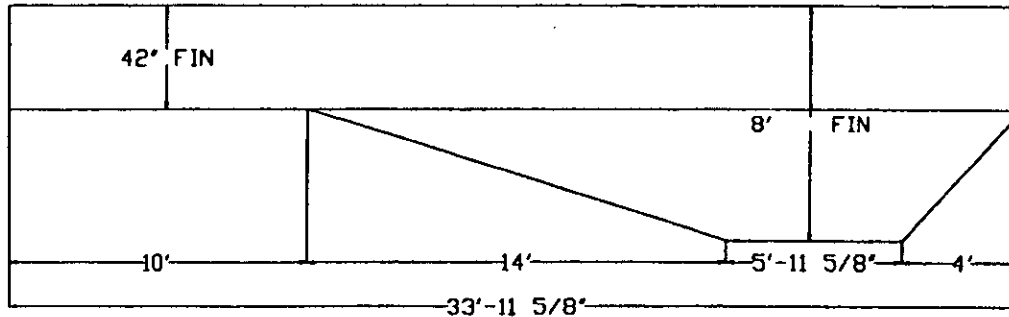

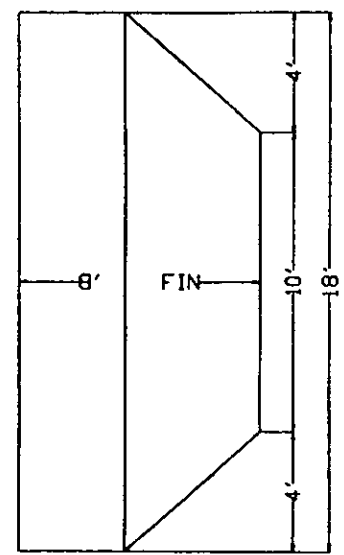
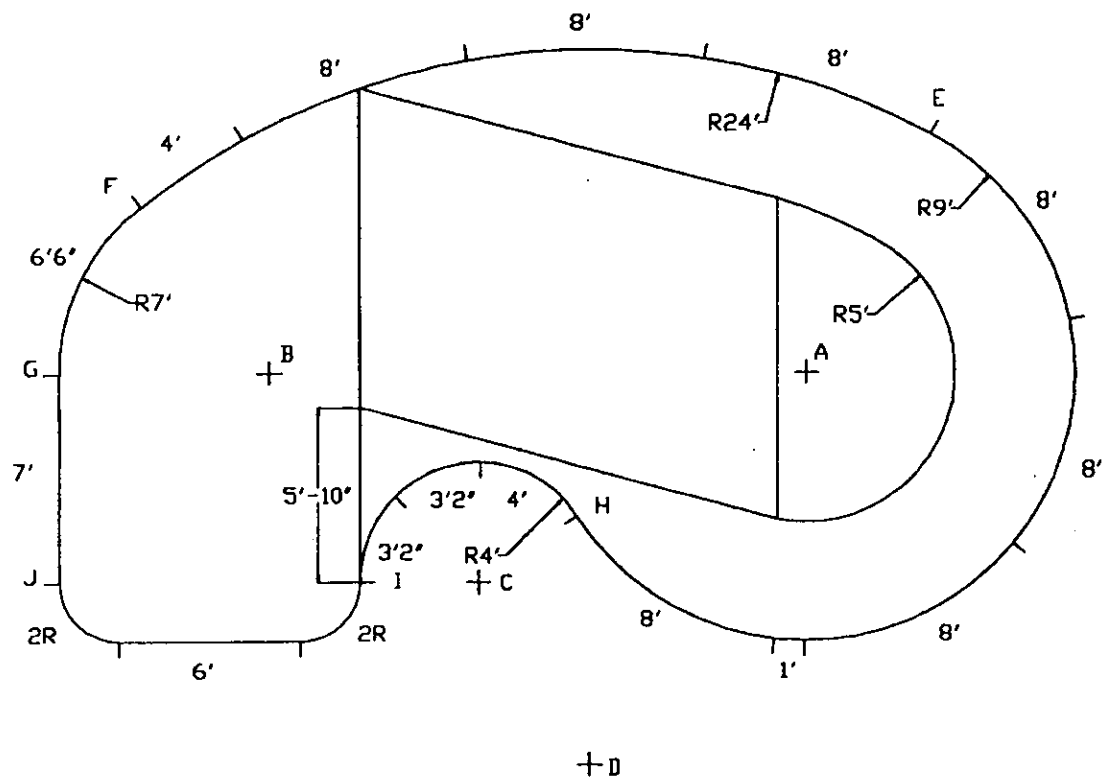

STAKE OUT			
A-B	17'-11-5/8"	I-E	24'-3-3/4"
A-C	13'-1/8"	I-F	14'-6-1/8"
A-D	15'	I-G	12'-2-1/2"
B-C	9'-10-3/4"	I-H	7'-8-1/8"
B-D	17'	I-J	10"



24 BAKER ST., P.O. BOX 100, HASTINGS DN, KOL-1Y0  
 705-696-2385, 1-800-465-3433, FAX 705-696-1922

### 19' X 34' L.H. PALETTE

QTY.	LENGTH	RADIUS	TYPE
2	8'0"	24'0"	PLAIN
1	8'0"	24'0"	SKIMMER
1	4'0"	24'0"	PLAIN
3	8'0"	9'0"	PLAIN
1	8'0"	9'0"	RETURN
1	1'0"	9'0"	PLAIN
1	6'6"	7'0"	PLAIN
1	4'0"	4'0"	REVERSE
2	3'2"	4'0"	REVERSE
2	3'2"	2'0"	CORNER
1	7'0"	NA	RETURN
1	6'0"	NA	PLAIN
17	-	NA	A-FRAME
1	-	NA	N&B PKG
			S.A. 527 sq.ft.
			PER. 97'2"
1934PALC			DATE: 16-11-00

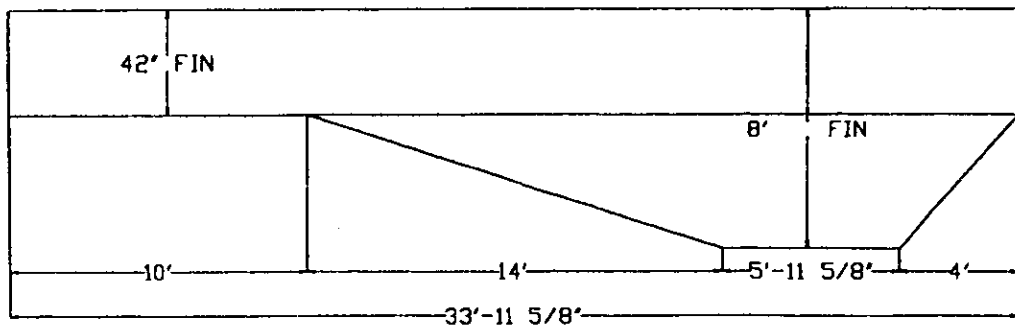



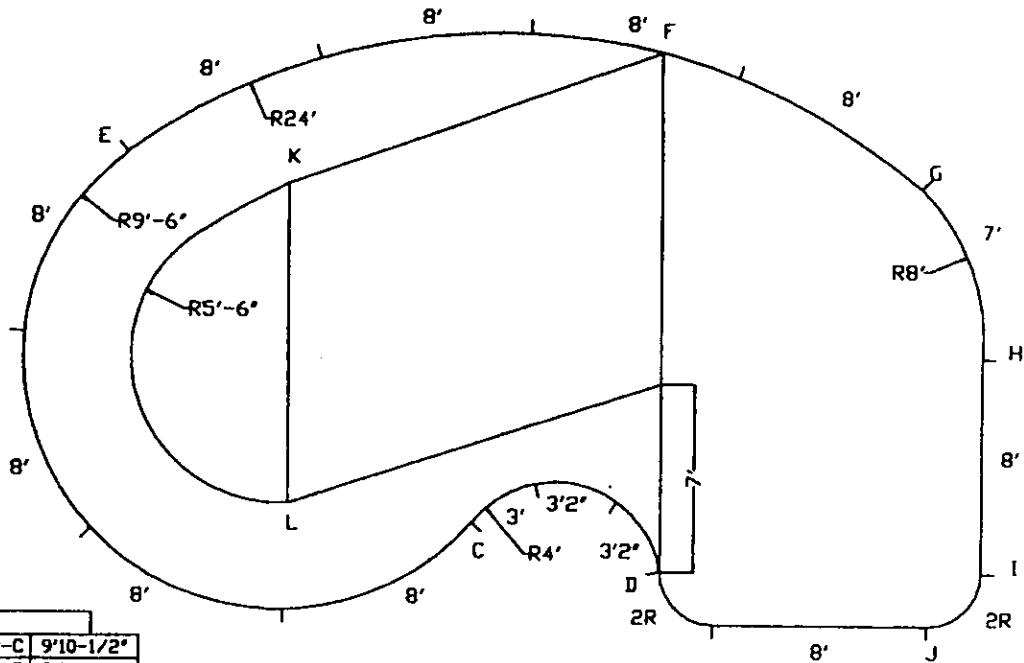
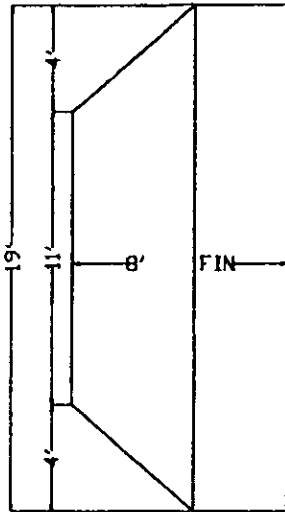

STAKE OUT			
A-C	11'11-5/8"	B-C	9'10-1/2"
A-D	16'2"	B-D	8'7-7/8"
A-E	23'11-1/4"	B-E	28'-3/8"
A-F	30'6"	B-F	27'3-3/8"
A-G	32'5-3/4"	B-G	25'11-3/4"
A-H	30'6-1/2"	B-H	22'6"
A-I	27'4-1/2"	B-I	17'11-1/2"
A-J	24'11-1/4"	B-J	15'4"
A-K	22'-1/4"	B-K	24'-1/2"
A-L	10'-1/4"	B-L	13'11"
A-M		B-M	

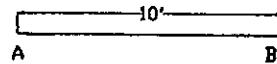

24 BAKER ST. P.O. BOX 100, HASTINGS ON KOL-1Y0  
705-696-2385, 1-800-465-3433, FAX 705-696-1922

### 22'X36' R.H. PALETTE

QTY.	LENGTH	RADIUS	TYPE
3	8'0"	24'0"	PLAIN
1	8'0"	24'0"	SKIMMER
3	8'0"	9'6"	PLAIN
1	8'0"	9'6"	RETURN
1	7'0"	8'0"	PLAIN
2	3'2"	4'0"	REVERSE
1	3'0"	4'0"	REVERSE
2	3'2"	2'0"	CORNER
1	8'0"	NA	RETURN
1	8'0"	NA	PLAIN
16	-	NA	A-FRAME
1	-	NA	N&B PKG
			S.A. 616 sq.ft.
			PER: 102'8"
2236PALC			DATE: 16-11-00

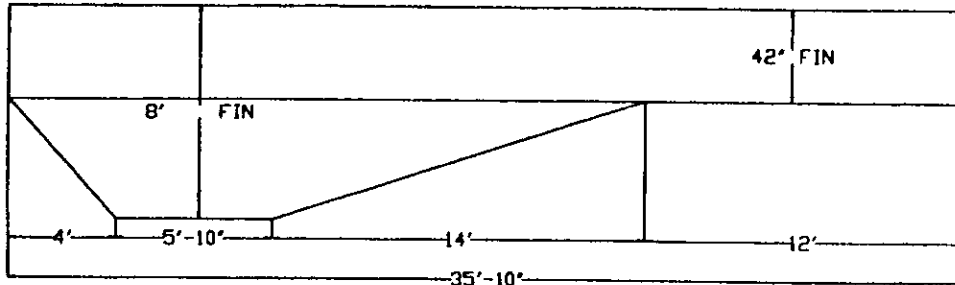

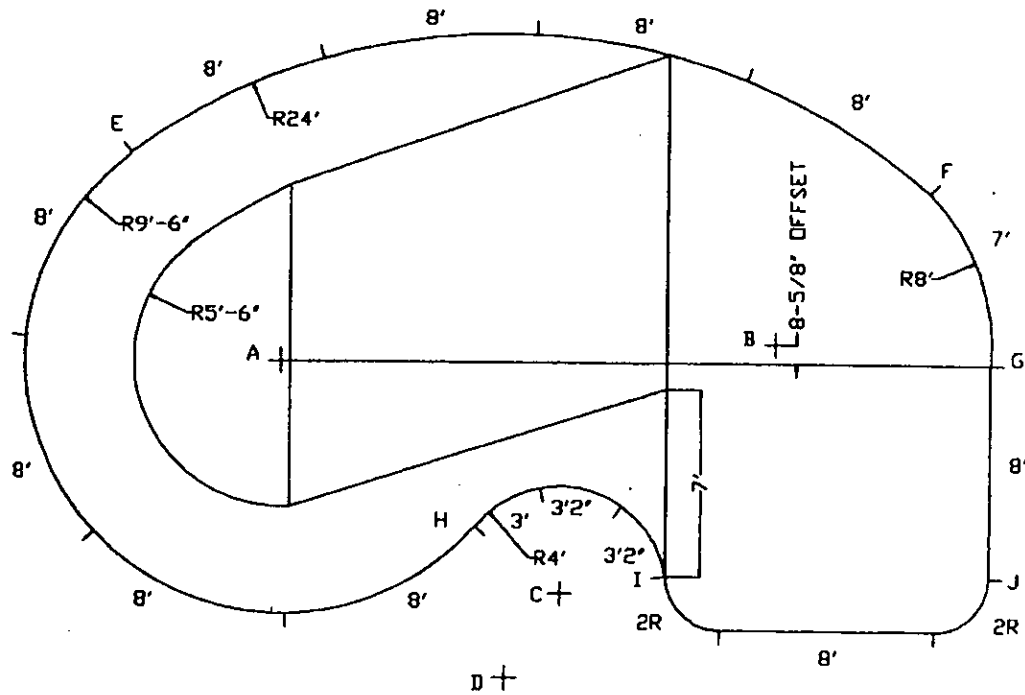
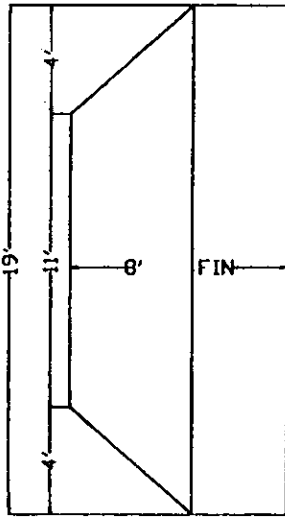

24 BAKER ST, P.O. BOX 100, HASTINGS ON KOL - 1Y0  
 705-696-2385, 1-800-465-3433, FAX: 705-696-1922

**22'X36' R.H. PALETTE**

QTY.	LENGTH	RADIUS	TYPE
3	8'0"	24'0"	PLAIN
1	8'0"	24'0"	SKIMMER
3	8'0"	9'6"	PLAIN
1	8'0"	9'6"	RETURN
1	7'0"	8'0"	PLAIN
2	3'2"	4'0"	REVERSE
1	3'0"	4'0"	REVERSE
2	3'2"	2'0"	CORNER
1	8'0"	NA	RETURN
1	8'0"	NA	PLAIN
16	-	NA	A-FRAME
1	-	NA	N&B PKG
			S.A.: 616 sq.ft.
			PER: 102'8"
2236PALC			DATE: 16-11-00

STAKE OUT			
A-B	18'4-1/2"	I-E	25'4-3/4"
A-C	13'6-1/4"	I-F	17'-4"
A-D	14'5-1/2"	I-G	14'5-1/8"
B-C	12'3-3/4"	I-H	7'4-1/8"
B-D	16'-3/8"	I-J	12'

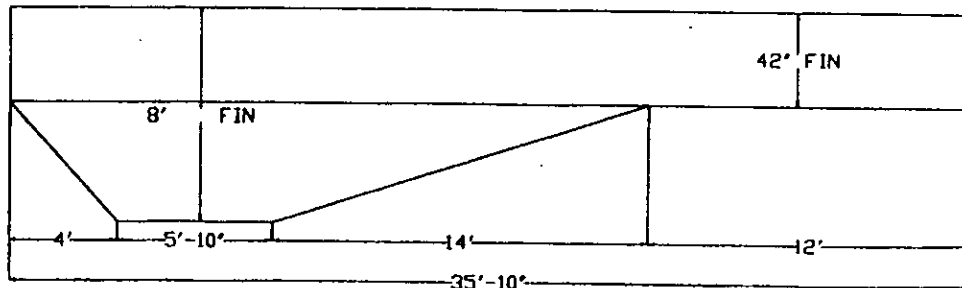

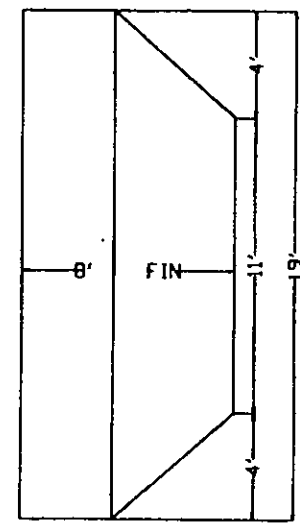
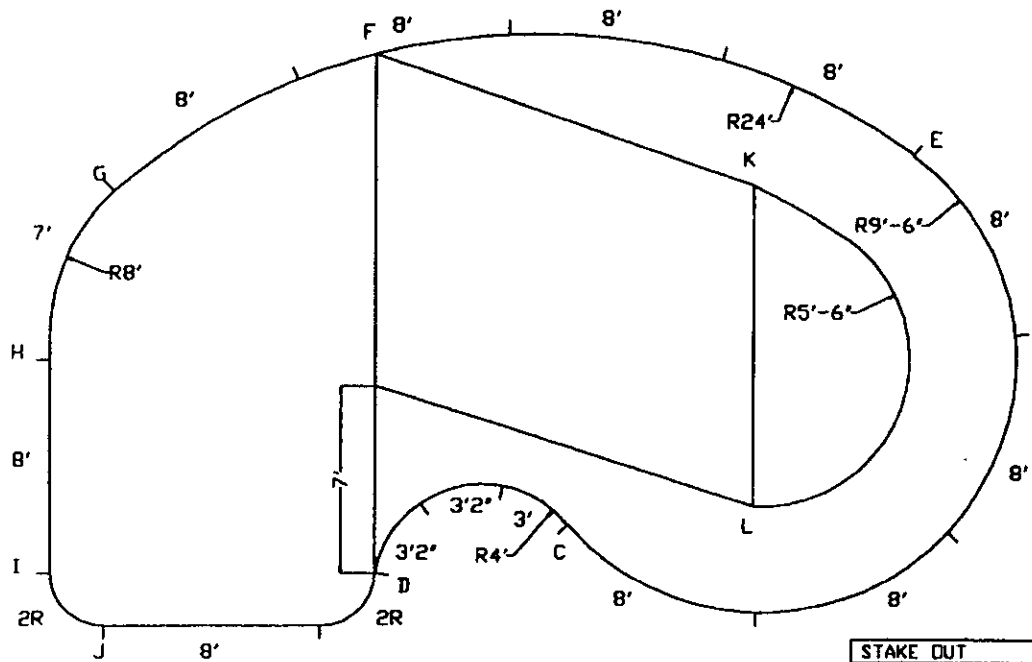

STAKE OUT			
A-C	11'11-5/8"	B-C	9'10-1/2"
A-D	16'2"	B-D	8'7-7/8"
A-E	23'11-1/4"	B-E	28'-3/8"
A-F	30'6"	B-F	27'3-3/8"
A-G	32'3-3/4"	B-G	25'11-3/4"
A-H	30'6-1/2"	B-H	22'6"
A-I	27'4-1/2"	B-I	17'11-1/2"
A-J	24'11-1/4"	B-J	15'4"
A-K	22'-1/4"	B-K	24'-1/2"
A-L	10'-1/4"	B-L	13'11"
A-M		B-M	

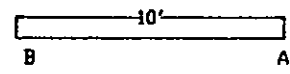

24 BAKER ST. P.O. BOX 100, HASTINGS ON KOL-1YO  
 705-696-2385, 1-800-465-3433, FAX: 705-696-1922

### 22'X36' L.H. PALETTE

QTY.	LENGTH	RADIUS	TYPE
3	8'0"	24'0"	PLAIN
1	8'0"	24'0"	SKIMMER
3	8'0"	9'6"	PLAIN
1	8'0"	9'6"	RETURN
1	7'0"	8'0"	PLAIN
2	3'2"	4'0"	REVERSE
1	3'0"	4'0"	REVERSE
2	3'2"	2'0"	CORNER
1	8'0"	NA	RETURN
1	8'0"	NA	PLAIN
16	-	NA	A-FRAME
1	-	NA	N&B PKG
			S.A.: 616 sq.ft.
			PER: 102'8"
2236PALC			DATE: 16-11-00

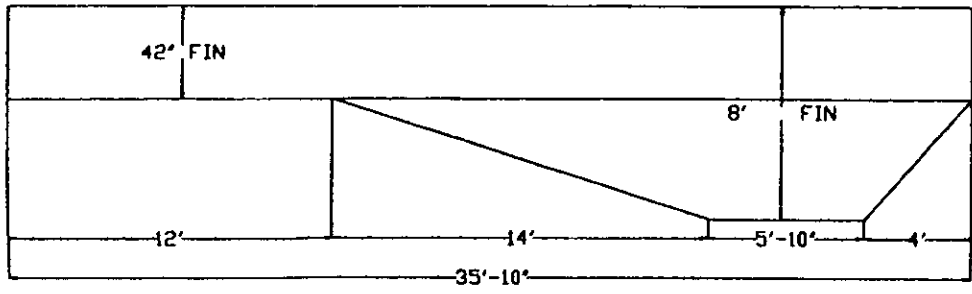

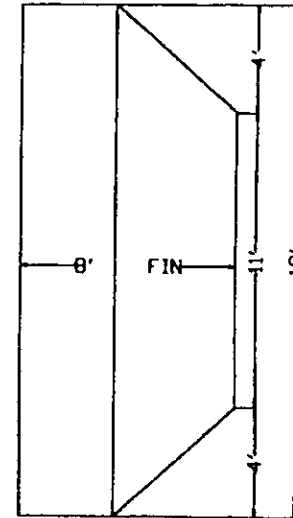
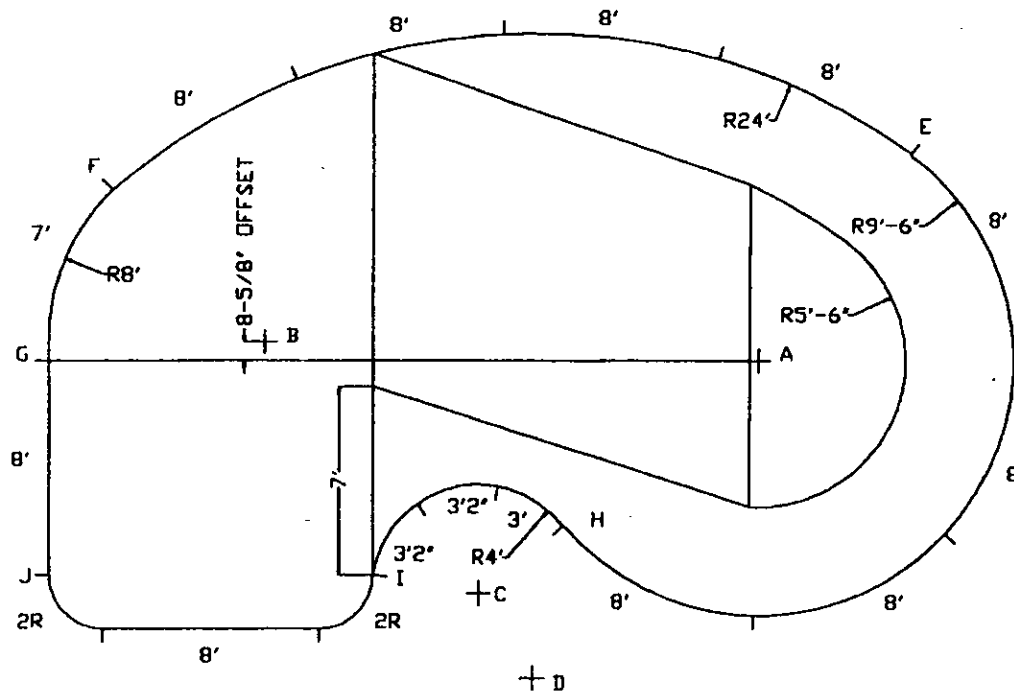

STAKE OUT			
A-B	18'-1/2"	I-E	25'-3/4"
A-C	13'-1/4"	I-F	17'-4"
A-D	14'-5-1/2"	I-G	14'-5-1/8"
B-C	12'-3-3/4"	I-H	7'-4-1/8"
B-D	16'-3/8"	I-J	12"



24 BAKER ST. P.O. BOX 100, HASTINGS ON KOL-1YO  
705-696-2385, 1-800-465-3433, FAX: 705-696-1922

### 22'X36' L.H. PALETTE

QTY.	LENGTH	RADIUS	TYPE
3	8'0"	24'0"	PLAIN
1	8'0"	24'0"	SKIMMER
3	8'0"	9'6"	PLAIN
1	8'0"	9'6"	RETURN
1	7'0"	8'0"	PLAIN
2	3'2"	4'0"	REVERSE
1	3'0"	4'0"	REVERSE
2	3'2"	2'0"	CORNER
1	8'0"	NA	RETURN
1	8'0"	NA	PLAIN
16	-	NA	A-FRAME
1	-	NA	N&B PKG
			S.A. 616 sq.ft.
			PER. 102'8"
2236PALC			DATE: 16-11-00

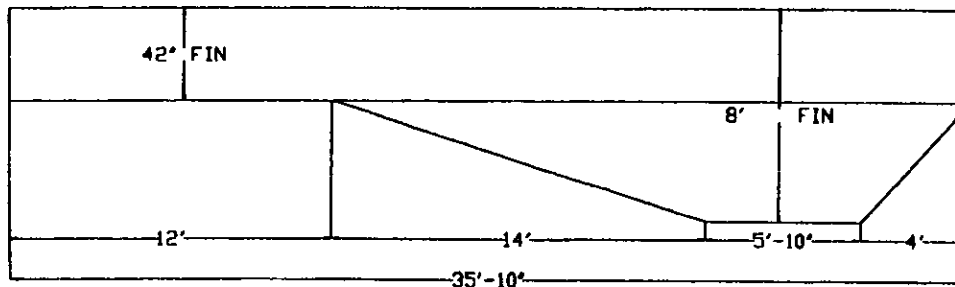

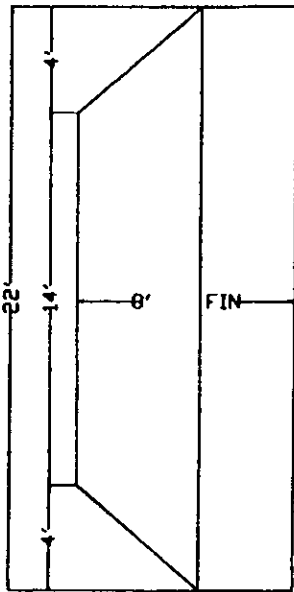

24 BAKER ST. P.O. BOX 100, HASTINGS ON, KOL - 1Y0  
 705-696-2385, 1-800-465-3433, FAX: 705-696-1922

**24'X40' R.H. PALETTE**

QTY.	LENGTH	RADIUS	TYPE
3	8'0"	24'0"	PLAIN
1	8'0"	24'0"	SKINNER
1	6'0"	24'0"	PLAIN
3	8'0"	11'0"	PLAIN
1	8'0"	11'0"	RETURN
1	6'0"	11'0"	PLAIN
1	5'0"	7'0"	PLAIN
1	4'0"	4'0"	REVERSE
2	3'2"	4'0"	REVERSE
2	3'2"	2'0"	CORNER
1	8'0"	NA	PLAIN
1	8'0"	NA	PLAIN
18	-	NA	A-FRAME
1	-	NA	NLB PKG
			S.A.: 755 sq.ft.
			PER: 113'8"
2440PALC			DATE: 16-11-00

STAKE OUT			
A-C	14'6-1/2"	B-C	11'2-1/2"
A-D	18'10-7/8"	B-D	11'2"
A-E	26'6-1/4"	B-E	30'8-5/8"
A-F	33'7-3/8"	B-F	29'11-1/2"
A-G	34'6"	B-G	27'5"
A-H	33'3-1/2"	B-H	25'2-5/8"
A-I	30'	B-I	20'8-1/4"
A-J	27'6-3/8"	B-J	18'-1/2"
A-K	26'2-5/8"	B-K	27'1-1/4"
A-L	10'10-3/4"	B-L	12'10-3/4"
A-M		B-M	

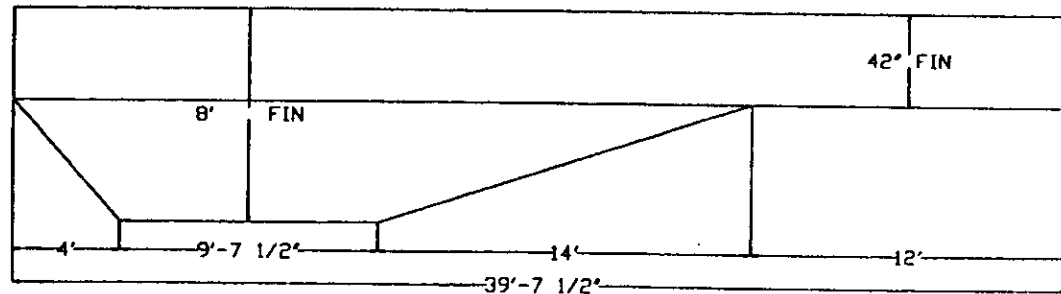
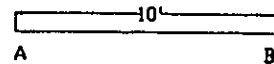
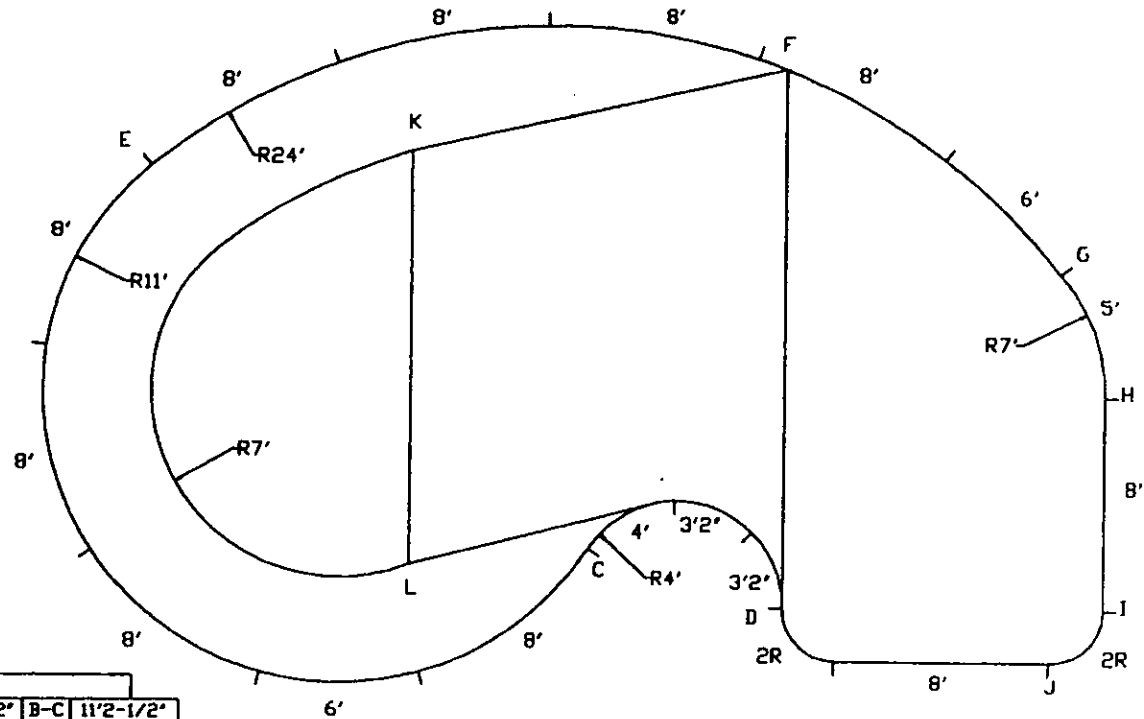

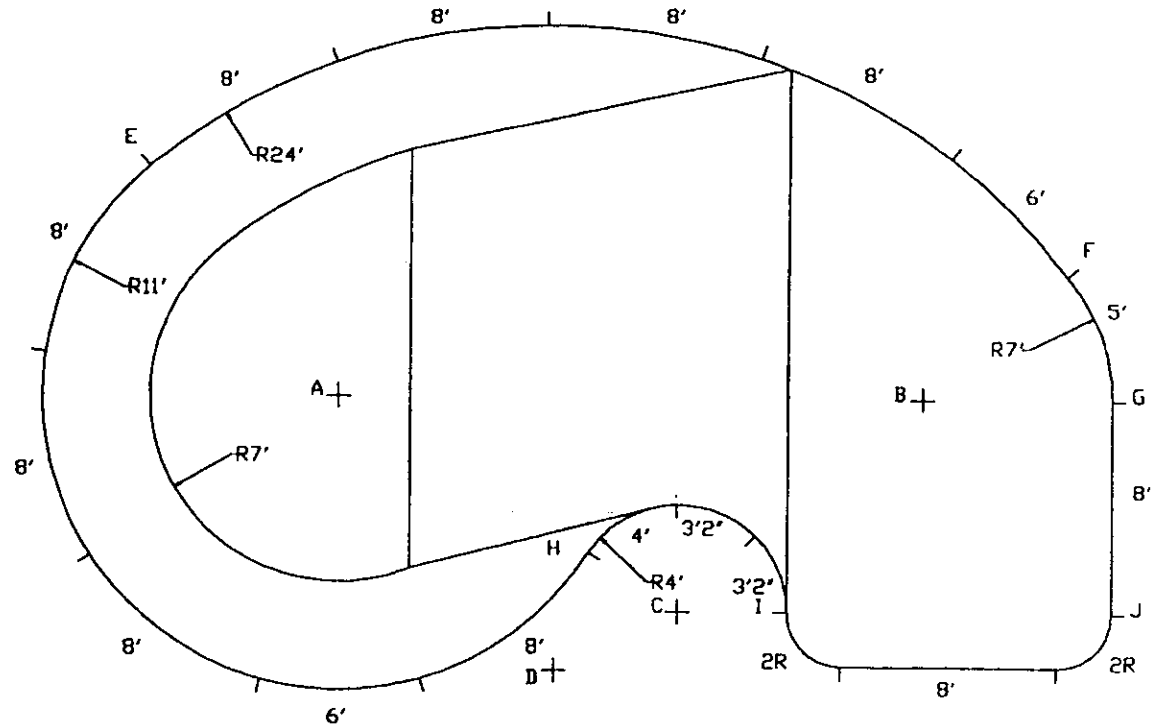
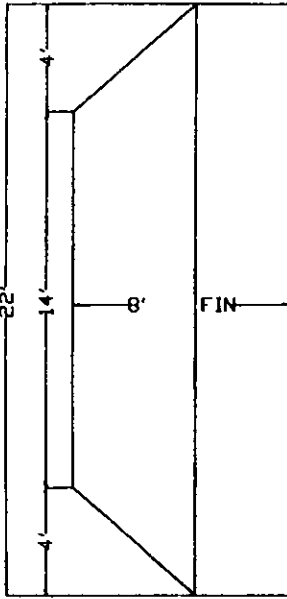

24 BAKER ST, P.O. BOX 100, HASTINGS ON KOL - 1Y0  
 705-696-2385, 1-800-465-3433, FAX: 705-696-1922

**24'X40' R.H. PALETTE**

QTY.	LENGTH	RADIUS	TYPE
3	8'0"	24'0"	PLAIN
1	8'0"	24'0"	SKIMMER
1	6'0"	24'0"	PLAIN
3	8'0"	11'0"	PLAIN
1	8'0"	11'0"	RETURN
1	6'0"	11'0"	PLAIN
1	5'0"	7'0"	PLAIN
1	4'0"	4'0"	REVERSE
2	3'2"	4'0"	REVERSE
2	3'2"	2'0"	CORNER
1	8'0"	NA	PLAIN
1	8'0"	NA	PLAIN
18	-	NA	A-FRAME
1	-	NA	N&B PKG
			S.A.: 755 sq.ft.
			PER: 113'8"
2440PALC			DATE: 16-11-00

STAKE OUT			
A-B	21'7-7/8"	I-E	28'10-5/8"
A-C	15'	I-F	16'3-1/8"
A-D	13'	I-G	14'5-1/8"
B-C	12'-1/2"	I-H	7'8"
B-D	17'-1/8"	I-J	12'

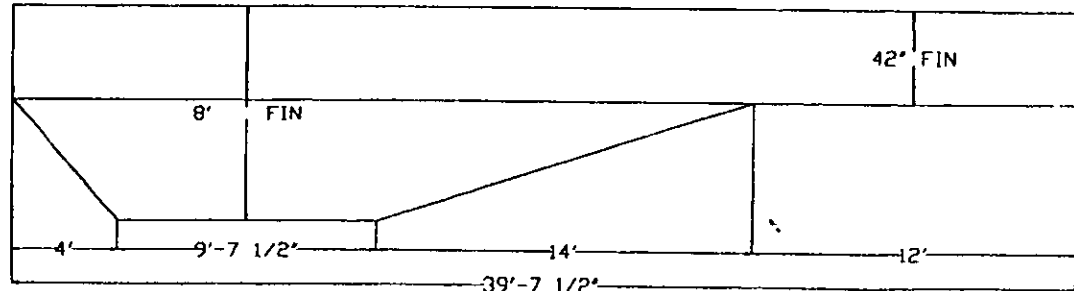

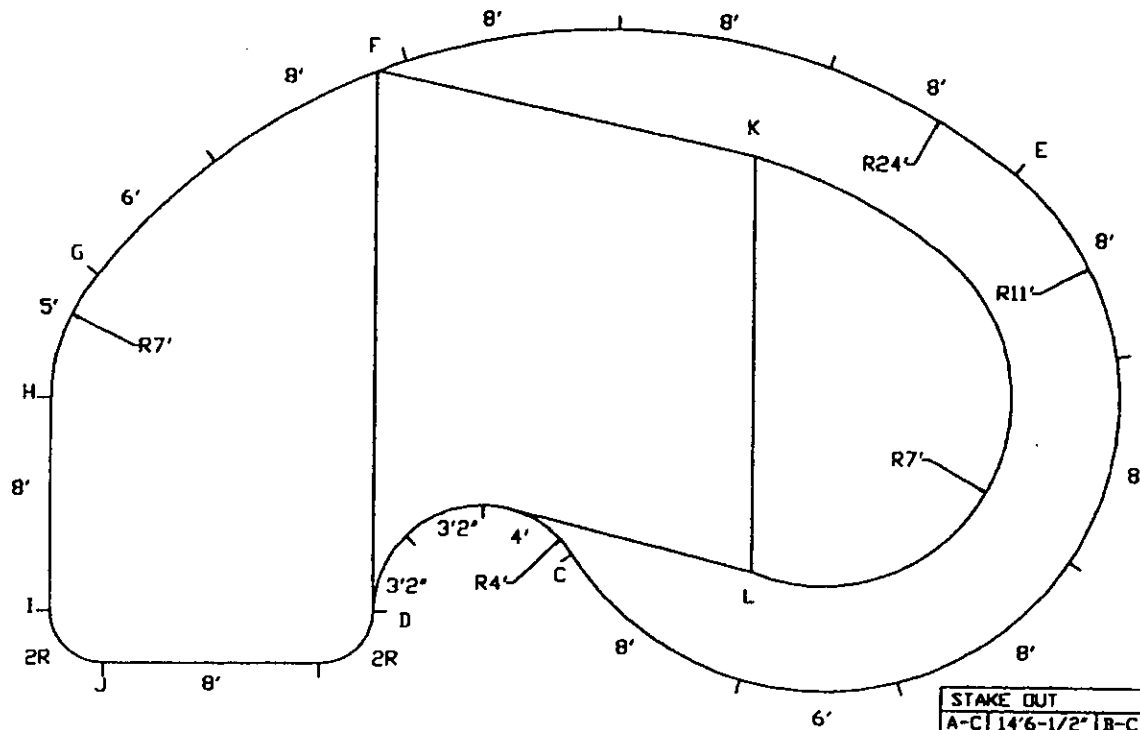

STAKE OUT			
A-C	14'6-1/2"	B-C	11'2-1/2"
A-D	18'10-7/8"	B-D	11'2"
A-E	26'6-1/4"	B-E	30'8-5/8"
A-F	33'7-3/8"	B-F	29'11-1/2"
A-G	34'6"	B-G	27'5"
A-H	33'3-1/2"	B-H	25'2-5/8"
A-I	30'	B-I	20'8-1/4"
A-J	27'6-3/8"	B-J	18'-1/2"
A-K	26'2-5/8"	B-K	27'1-1/4"
A-L	10'10-3/4"	B-L	12'10-3/4"
A-M		B-M	

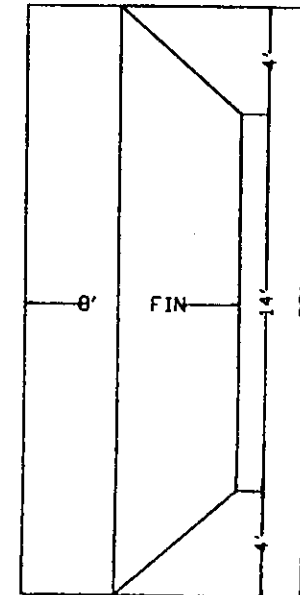

24 BAKER ST, P.O. BOX 100, HASTINGS ON KOL - 1Y0  
705-696-2383, 1-800-465-3433, FAX 705-696-1922

### 24'X40' L.H. PALETTE

QTY.	LENGTH	RADIUS	TYPE
3	8'0"	24'0"	PLAIN
1	8'0"	24'0"	SKIMMER
1	6'0"	24'0"	PLAIN
3	8'0"	11'0"	PLAIN
1	8'0"	11'0"	RETURN
1	6'0"	11'0"	PLAIN
1	5'0"	7'0"	PLAIN
1	4'0"	4'0"	REVERSE
2	3'2"	4'0"	REVERSE
2	3'2"	2'0"	CORNER
1	8'0"	NA	PLAIN
1	8'0"	NA	PLAIN
18	-	NA	A-FRAME
1	-	NA	N&B PKG
			S.A. 755 sq.Ft.
			PER: 113'8"
2440PALC			DATE: 16-11-00

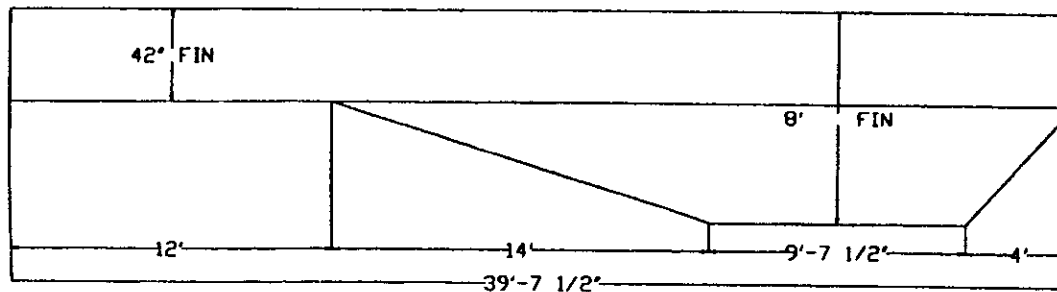

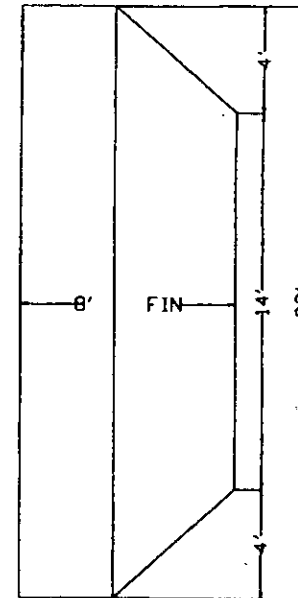
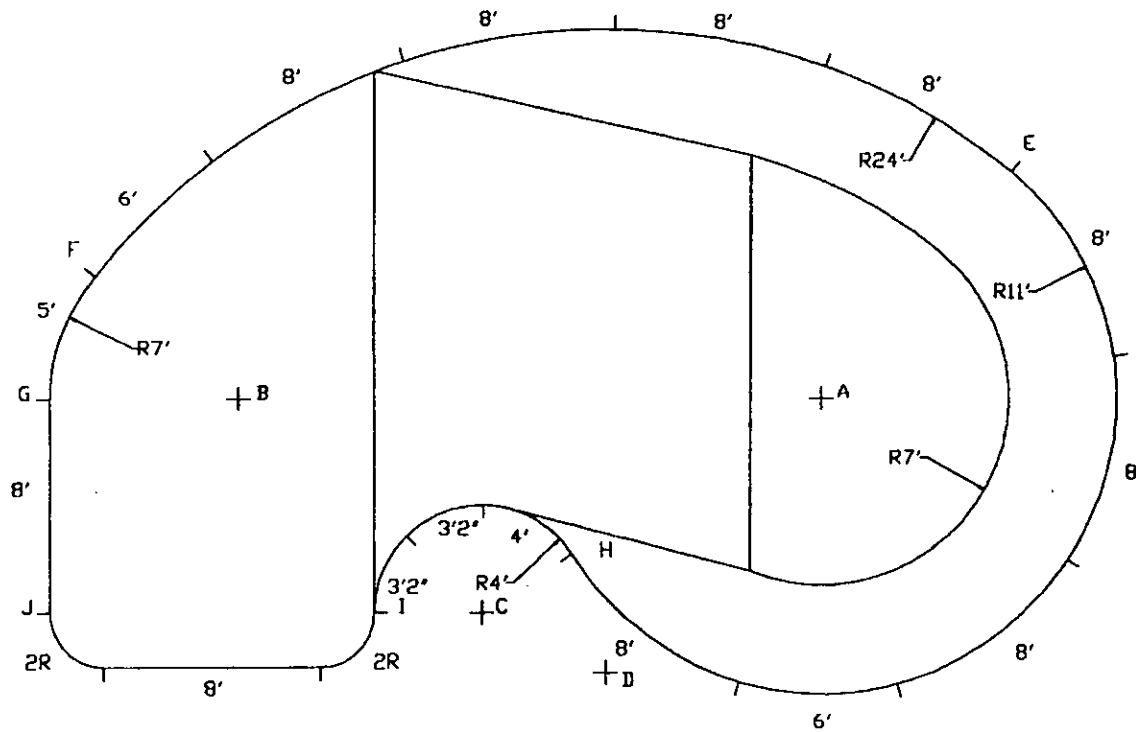

STAKE OUT

A-B	21'7-7/8"	I-E	28'10-5/8"
A-C	15'	I-F	16'3-1/8"
A-D	13'	I-G	14'5-1/8"
B-C	12'-1/2"	I-H	7'8"
B-D	17'-1/8"	I-J	12'

24 BAKER ST., P.O. BOX 100, HASTINGS ON KOL - IYO  
705-696-2385, 1-800-465-3433, FAX: 705-696-1922

24'X40' L.H. PALLETTE

QTY.	LENGTH	RADIUS	TYPE
3	8'0"	24'0"	PLAIN
1	8'0"	24'0"	SKIMMER
1	6'0"	24'0"	PLAIN
3	8'0"	11'0"	PLAIN
1	8'0"	11'0"	RETURN
1	6'0"	11'0"	PLAIN
1	5'0"	7'0"	PLAIN
1	4'0"	4'0"	REVERSE
2	3'2"	4'0"	REVERSE
2	3'2"	2'0"	CORNER
1	8'0"	NA	PLAIN
1	8'0"	NA	PLAIN
18	-	NA	A-FRAME
1	-	NA	N&B PKG
			S.A.: 755 sq.ft.
			PER: 113'8"
2440PALC			DATE: 16-11-00

