

INSTALLATION INSTRUCTIONS

HONEYCOMB SHADES

TOP-DOWN, MOVABLE ARCH

Thank you for your purchase. This shade has been custom built for you from the highest quality materials.

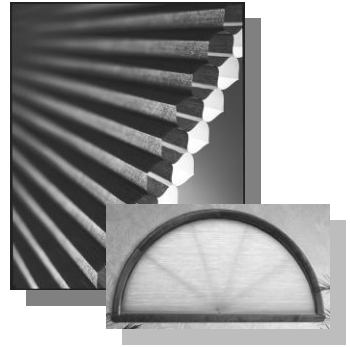

To avoid errors and save valuable time, please read these instructions before installing your new shade.

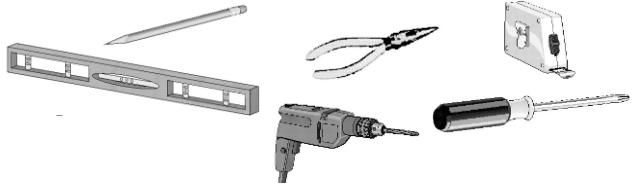

TOOLS YOU WILL NEED

1. Pencil or Marker
2. Measuring Tape
3. Needle-nose Pliers
4. Phillips Screwdriver
5. Carpenter's Level
6. Power Drill
7. Mounting Fasteners









Mounting Surface	Fastener
Drywall, Plaster	Wall Anchors, Expansion Bolts (Not Provided) 
Metal	Sheet Metal Screws (Not Provided) 
Wood	No. 6 Hex Head Screws (Provided) 

GETTING STARTED

All the required installation components are wrapped in your package along with these instructions. Check that the parts you have correspond to the parts shown below. *NOTE: Some parts may vary depending upon your chosen mounting options.*

PARTS

- Swivel Installation Brackets (Inside Mounts) 
- Standard Installation Brackets (Outside Mounts) 
- Extension Bracket (optional) 
- Spacer Blocks (optional 3/4" or 3/8") 
- Arch KIT: Joiner Ball, Washers & Top Block(s) 
- Screws 
- Extension Pole (optional) 

MOVABLE ARCH TYPES - OVERVIEW

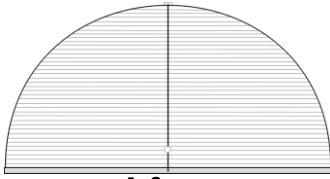

1-String

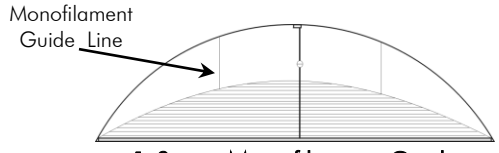

1-String Monofilament Guide

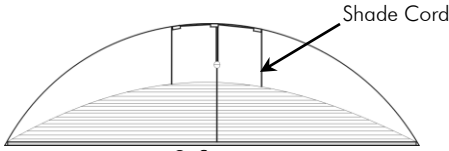

2-String

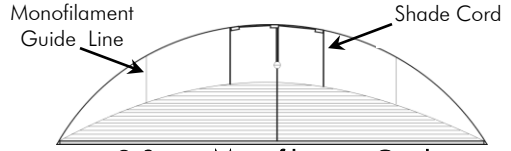

2-String Monofilament Guide

INSTALLATION INSTRUCTIONS - OVERVIEW

Mounting Brackets Overview	Page 3
Inside Mount Installations	Page 4
Optional Arch Trim	Page 6
Outside Mounts Installations	Page 7
End Mounts Installations (Over Rectangular Shades)	Page 9
Shades With Monofilament Guides	Page 9
Joiner Ball Installation & Adjustment (All Mount Types)	Page 10
Operating The Shade	Page 11
Trouble Shooting	Page 11
Care & Cleaning	Page 12
Warranty	Page 13
Warning	Page 14

MOUNTING BRACKETS - OVERVIEW

Swivel installation brackets will be used for normal **INSIDE** mounts. Standard installation brackets will be used for all **OUTSIDE** mounts. End installation brackets will be used for **END (SIDE)** mounts when arches are installed over rectangular shades. [NOTE: for each of these bracket types, there is a small size (for 3/8" honeycomb shades) and a large size (for 3/4" and 1/2" honeycomb shades).

Mounting the brackets level is essential for proper operation of the shade.

- The swivel and standard bracket requirements and placements are the same for inside and outside mounts. Mount installation brackets **3" from each end** of the shade. Space any additional brackets evenly. Refer to the following spacing diagram and bracket requirement chart.

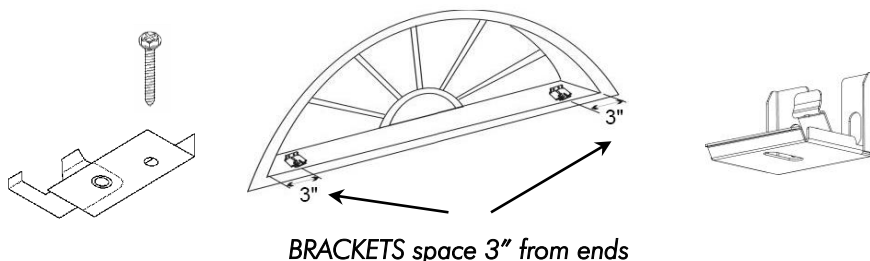

Installation Bracket Requirement Chart – Swivel & Standard

Shade Width	Brackets Required
18" to 40"	2
40-1/8" to 72"	3
72-1/8" and over	4

- Specialty end-mount brackets will be installed just off the shade ends for inside mounts onto a recessed surface area above a rectangular shade. The maximum shade width for this installation type is 48" and only 2 brackets will be used.

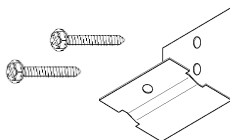

Installation Bracket Requirement Chart – End

Shade Width	Brackets Required
18" to 48"	2

INSIDE MOUNT INSTALLATIONS

For inside mounts the swivel installation brackets will be screwed in place through the center hole(s) of each bracket. The back leg of the swivel brackets will face upward and install flush to the back side of the shade's bottom rail. Refer to the depth chart below.

Inside Mount Depth Requirements

Bracket Type	Minimum Depth	Fully Recessed
3/8" Swivel	1/2"	1-1/8"
3/4" Swivel	1/2" (1 screw) 7/8" (2 screws)	2"

NOTE: Prior to mounting the brackets, consider any clearance depth required to avoid obstructions such as window cranks or handles. **For the best fit on a non-perfect half circle, in a deeply recessed window opening, position the brackets close to the original depth that the template was made.**

MARK THE BRACKET POSITIONS:

- Mark where the ends of the bottom rail will be positioned.
- Then mark 3" in from the bottom rail end-marks for the installation brackets.

ATTACH THE BRACKETS:

- Screw 3/8" swivel bracket through 1 center hole.
- Screw 3/4" swivel bracket through 2 center holes.

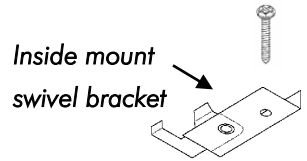

INSTALL THE SHADE (MOUNT THE BOTTOM RAIL):

- Open the swivel brackets by rotating the swivel tab.
- With the front (colored) side of the shade facing you ...
- Position the bottom rail against the back side of the brackets.
- Close the swivel tab (rotate forwards) until it grabs UNDER the bottom rail ridge.
- Ensure the swivel tab is flush against the front of the bottom rail to lock in place.

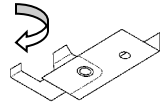

MARK THE TOP BLOCK POSITION: 1-STRING SHADES

- Place a mark at the top center of the window opening.

ATTACH THE TOP BLOCK: 1-STRING SHADES

- Align the **groove** of the top block with the center mark.
- Ensure the front of the top block is aligned with the front of the shade.
- NOTE: DO NOT position the top block so that the screw hole is center.
- Ensure that the screw hole is 3/8" off center.
- Screw the top block in place. Before tightening all the way ...

- Loop the shade cord into the top block groove so that the top half of the joiner ball is coming out of the front of the top block.

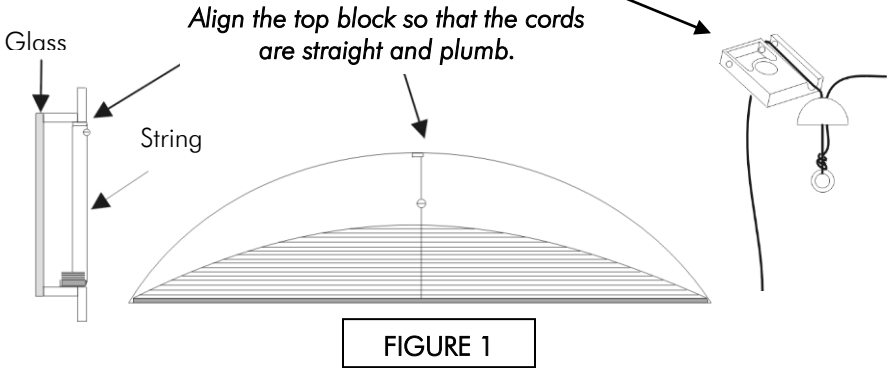

MARK THE TOP BLOCK POSITIONS: 2-STRING SHADES

- Place a mark at the top center of the window opening.
- Measure the distance between the two cords coming out the top cell of the shade.
- NOTE: the distance was determined by the curvature in the arch.
- At the top of the arch opening, mark to the left and right of the middle mark ...
- These marks correspond to the distance each cord is left and right of center.

ATTACH THE TOP BLOCKS: 2-STRING SHADES

- The center top block is already attached to the cords..
- Screw the center top block in place ...
- Ensure that the groove for the cords is centered over the eyelet on the bottom rail.
- Screw the outer top blocks to the frame. Before tightening all the way ...
- Loop the left and right cords into their corresponding grooves and then tighten.

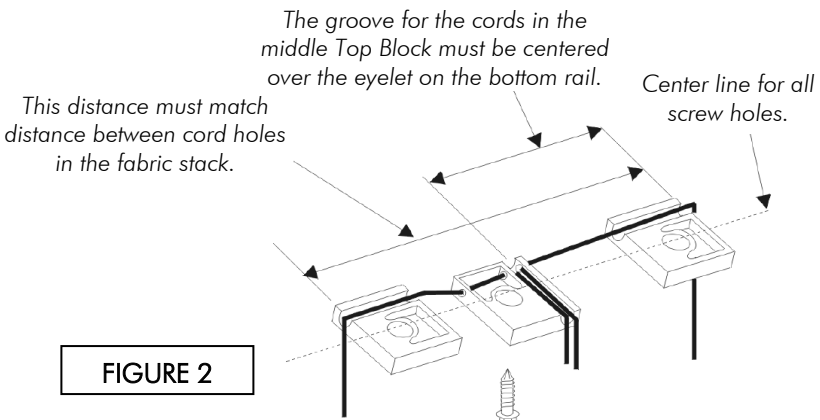

OPTIONAL ARCH TRIM

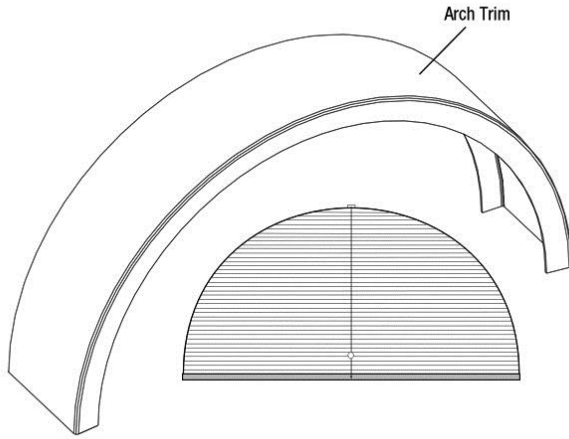

- To size the trim, position it along the entire curved surface, inside the window frame.
- Mark where to cut the arch trim. With inside-mounted shades, the ends of the trim should rest on the bottom of the window casement.
- Cut the arch trim to the correct length using a utility knife.
- For a shade with a wider bottom rail, cut a notch into the bottom back of the arch trim to accommodate the rail, as shown in the photo above.
- Place the trim back into the casement and line up the trim with both ends of the bottom rail, flush with the front of the casement.
- Attach the arch trim, using the screws provided.

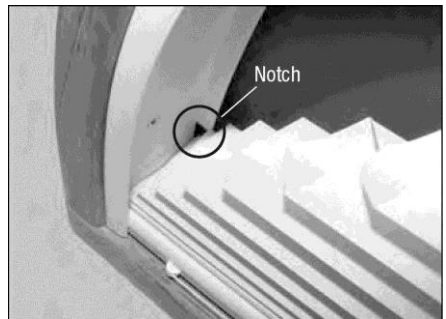

OUTSIDE MOUNT INSTALLATIONS

For outside mounts the standard installation brackets will be screwed in place through the two back holes of each bracket. Refer to the minimum surface height chart below.

Outside Mount Surface Height Requirements

Bracket Size	Minimum Height
3/8" Bracket	5/8"
3/4" Bracket	1"

MARK THE BRACKET POSITIONS:

- Mark where the ends of the headrail will be positioned. Either...
- Hold shade up and mark positions or measure bottom rail and mark width.
- Then mark 3" in from the bottom rail end-marks for the installation brackets.

ATTACH THE BRACKETS:

- Screw standard brackets through two back holes.

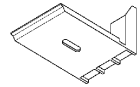

SPACER BLOCKS (optional):

- Spacer blocks will be attached to the end of each bracket.
- Ensure the screws are long enough to secure brackets to surface.
- Do not use more than three spacer blocks per bracket.
- If installing extension brackets, do not use spacer blocks.

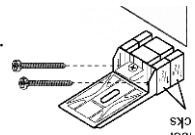

EXTENSION BRACKETS (optional):

- Position the extension brackets to the desired wall location.
- The bracket tops must be aligned and level to one another.
- Mount the extension brackets through the back holes.
- Attach the installation brackets to the extension brackets.
- Use the same holes for all brackets to ensure an even projection.

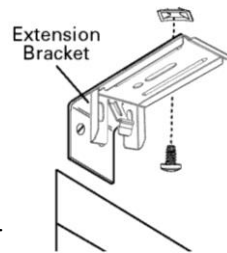

MARK THE TOP BLOCK POSITION: 1-STRING SHADES

- Place a mark at the top center of the window opening.

INSTALL THE SHADE (MOUNT THE BOTTOM RAIL):

- With the front (colored) side of the shade facing you ...
- Tilt the bottom rail slightly forward to angle the back inside lip to the brackets.
- Rotate bottom rail upward to snap into place.

- To **REMOVE** shade, maintain hold on shade and loosen tabs with screwdriver.

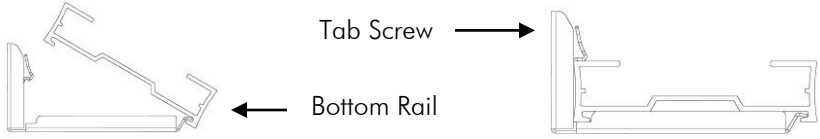

ATTACH THE TOP BLOCK: 1-STRING SHADES

- Align the **groove** of the top block with the center mark.
- Ensure the front of the top block is aligned with the front of the shade.
- NOTE: DO NOT** position the top block so that the screw hole is center.
- Ensure that the screw hole is 3/8" off center.
- Screw the top block in place. Before tightening all the way ...
- Loop the shade cord into the top block groove so that the top half of the joiner ball is coming out of the front of the top block.

Make sure the Top Block is positioned so that the cords are straight and plumb.

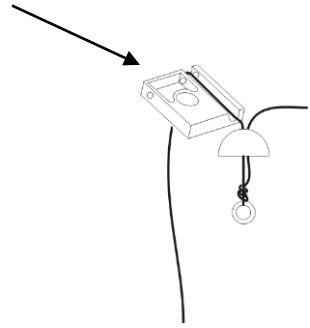
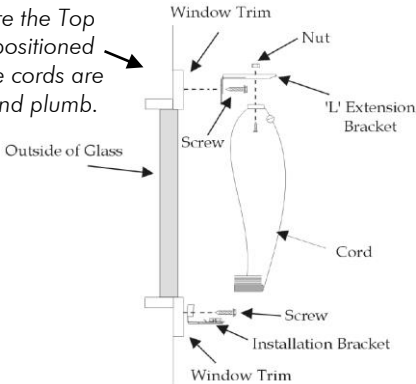

FIGURE 3

MARK THE TOP BLOCK POSITIONS: 2-STRING SHADES

- Place a mark at the top center of the window opening.
- Measure the distance between the two cords coming out the top cell of the shade.
- NOTE:** the distance was determined by the curvature in the arch.
- At the top of the arch opening, mark to the left and right of the middle mark ...
- These marks correspond to the distance each cord is left and right of center.

ATTACH THE TOP BLOCKS: 2-STRING SHADES

- The center top block is already attached to the cords..
- Screw the center top block in place ...
- Ensure that the groove for the cords is centered over the eyelet on the bottom rail.
- Screw the outer top blocks to the frame/bracket. Before tightening all the way ...
- Loop the left and right cords into their corresponding grooves and then tighten.

NOTE: SEE 2-STRING DIAGRAM UNDER INSIDE MOUNTS (**FIGURE 2**).

END MOUNT INSTALLATIONS

END (INSIDE) MOUNTS OVER RECTANGULAR SHADE:

For end mounts the specialty end brackets will be screwed in place through the two holes of each bracket. These are used for inside mount side-surface areas and will typically be installed over an end (inside) mounted rectangular shade. Refer to the minimum surface height chart below.

End Mount Surface Height Requirements

Bracket Size	Minimum Height
3/8" Bracket	7/8"
3/4" Bracket	1"

NOTE: Prior to mounting the brackets, **remove the plastic end-caps from each end of the arch bottom rail**. The end brackets will slide into the open ends of the bottom rail.

MARK THE BRACKET POSITIONS:

- Slide the end mount brackets into the open ends of the arch bottom rail.
- Hold shade up and mark positions **or** ...
- Place arch bottom rail onto rectangular shade headrail, align and mark positions.

INSTALL THE SHADE (MOUNT THE BOTTOM RAIL):

- Screw end brackets through two holes to desired location.

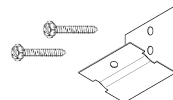

MARK AND ATTACH THE TOP BLOCK POSITION(S): 1 AND 2-STRING SHADES

- See INSIDE MOUNT instructions for TOP BLOCKS (above).

NOTE: SEE INSIDE MOUNT 1-STRING OR 2-STRING DIAGRAM (FIGURE 1 OR 2).

FOR SHADES WITH MONOFILAMENT GUIDES

For shades with monofilament guides, the line needs to be **straight** when the screw is tightened all the way. The screw will be secured to the window opening.

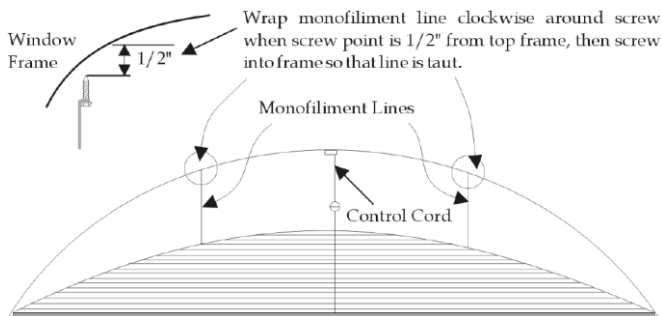

JOINER BALL INSTALLATION & ADJUSTEMENT

NOTE: Because each arch is custom made, slight adjustments may need to be made to position the joiner ball. Excess cord has been left for that purpose. **DO NOT** cut excess cord until you are completely satisfied with the operation of the shade.

ATTACH AND OPERATE THE JOINER BALL

- Screw the two halves of the Joiner Ball together and test the shade operation.
 1. The shade should go all the way up to the top block.
 2. The shade should go all the way down to the stack position.
 3. The shade should be able to stay in position in between and move without excess tension.

ADJUST AND OPERATE THE JOINER BALL

- If the shade goes all the way up and all the way down, but will not stay up without holding the cord, move the bottom half of the ball down (shorten lower cord) approximately 3/4". Test the operation and adjust again if necessary.
- If the shade operates with too much tension, move the bottom half of the ball up (lengthen bottom cord).
- If the shade will not go all the way up, but has correct tension, move both halves of the ball up (shorten upper cord and lengthen lower cord).
- If the shade will not go all the way down, but has correct tension, move both halves of the ball down (lengthen upper cord and shorten lower cord).
- If a 2-String shade does not appear level, or gaps on one side, adjust one or both of the cords coming into the top half of the ball.

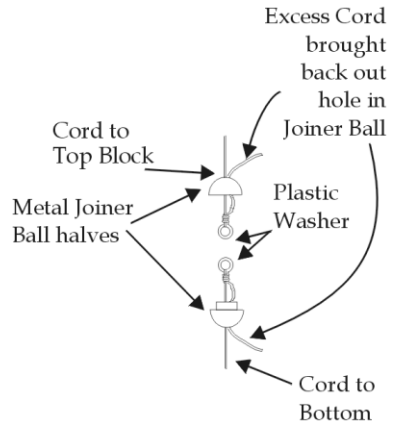

Once the shade has been adjusted properly and the shade goes all the way up and down, the excess cord can be trimmed near the upper and lower holes of the joiner ball.

STEP 4: OPERATING THE SHADE

TO RAISE AND LOWER THE SHADE:

- Pull the **Joiner Ball** up or down to raise, lower and position the shade.
- Or, use the (optional) extension pole with forked end to push/pull the ball.

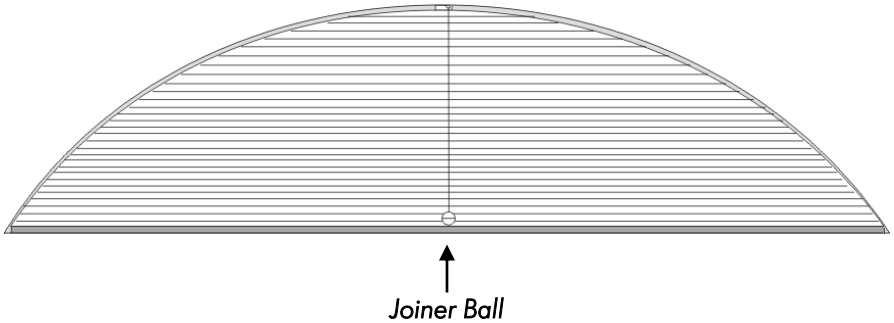

TROUBLE SHOOTING

Issue:	The shade will not go all the way up.
Cause:	Joiner Ball position not set correctly.
Adjustment:	Reposition the Joiner Ball. See section 3 for instructions.
Issue:	The shade will not go all the way down.
Cause:	Joiner Ball position not set correctly.
Adjustment:	Reposition the Joiner Ball. See section 3 for instructions.
Issue:	The shade will not stay up.
Cause:	Joiner Ball position not set correctly with enough cord tension.
Adjustment:	Reposition the Joiner Ball. See section 3 for instructions.
Issue:	The shade is difficult to operate.
Cause:	Joiner Ball position not set correctly, causing too much cord tension.
Adjustment:	Reposition the Joiner Ball. See section 3 for instructions.
Issue:	There is a gap on one side of the shade.
Cause:	Control cord is not straight and plumb.
Adjustment:	Check the position of the bottom rail and Top Block. The bottom rail must be centered in the window opening. Make sure that the Top Block is installed so that the groove is centered over the eyelet in the bottom rail. The screw should NOT be placed at center. The screw is 3/8" off center.

CLEANING INSTRUCTIONS

Honeycomb shades are made of an anti-static, dust resistant fabric which repels dirt and dust. For most of these fabrics, the following options are available if your shade needs cleaning.

DUSTING: Regular light dusting with a feather duster is all the cleaning needed in most circumstances.

VACUUMING: Use a hand-held vacuum with low suction for thorough dust removal.

SPOT CLEANING: Use these steps for spot cleaning: (1) Prepare a solution of warm water and mild dishwashing detergent. (2) Dampen a clean cloth in the solution and ring it out. (3) Dab the spot with the dampened cloth until it is gone. **DO NOT RUB THE FABRIC.** (4) Allow the shade to dry in the completely lowered position.

CAUTION: Avoid creasing Serenity or Opulence Blackout fabrics during cleaning.

DEEP CLEANING: Use the following steps for deep cleaning: (1) Immerse shade in basin or bathtub filled with warm water and mild detergent. (2) Rinse with clean water. (3) Fully raise shade and tilt to eliminate excess water, (4) Reinstall damp shade, lower it, and let it dry completely.

CAUTION: Do not immerse Serenity or Opulence Blackout fabrics. Do not immerse headrail in water.

ULTRASONIC CLEANING: Standard shades, except those made with Serenity or Opulence Blackout can be ultrasonically cleaned by a professional.

- Specify that a mild detergent be used.
- Never immerse the headrail in the solution.
- Dry the shade completely in the lowered position.

CAUTION: Do not ultrasonically clean Serenity or Opulence Blackout fabrics.

WARRANTY INFORMATION

Lifetime Limited Warranty covering our Custom Made Blinds

We extend this lifetime limited warranty to the original purchaser. This warranty applies only to manually operated Custom Products properly installed in the window, door or interior area for which they were intended. Installation of the product must be in accordance with accompanying instructions. The product cannot be modified. It is the purchaser's responsibility to maintain and clean the product in compliance with the instruction provided. The product must be used only in the window for which it was purchased. Damage to the product resulting from misuse, abuse, direct exposure to salty air or discoloration due to sunlight or the passage of time is not covered by this warranty.

This warranty does not apply to conditions caused by normal wear and tear upon the product. This warranty is exclusive and in lieu of all other obligations, liabilities or warranties. In no event shall the Manufacturer be liable for incidental or consequential damages or for any other direct or indirect damage, loss, cost, expense or fee. Some states do not allow the exclusion or limitation of incidental or consequential damages, so this exclusion or limitation may not apply to you.

In the event of a defect under this warranty, we will repair or replace the product, at our option, provided it is returned to our store. Our warranty obligation excludes shipping charges and labor costs for measuring and installation. Repairs will be made with like or similar parts. This warranty gives you specific legal rights, and you may have other rights which vary from state to state.

Notes: Motorization Systems are warranted for five years from the date of purchase. Specialty Blinds and Shades are warranted for one year from the date of purchase.

This warranty does not apply to Commercial Orders.

WARNING



**For more safety information
call 1-866-662-0666 or go to
www.healthcanada.gc.ca/blindcords**



Inner cords can pull out to form a loop, which can STRANGLE a young child.

- Children can climb furniture to access inner cords. Move cribs, playpens, and other furniture away from window coverings.

