

ATF-34143

Low Noise Pseudomorphic HEMT in a Surface Mount Plastic Package



Data Sheet

Description

Avago's ATF-34143 is a high dynamic range, low noise PHEMT housed in a 4-lead SC-70 (SOT-343) surface mount plastic package.

Based on its featured performance, ATF-34143 is ideal for the first stage of base station LNA due to the excellent combination of low noise figure and high linearity^[1]. The device is also suitable for applications in Wireless LAN, WLL/RLL, MMDS, and other systems requiring super low noise figure with good intercept in the 450 MHz to 10 GHz frequency range.

Note:

1. From the same PHEMT FET family, the larger geometry ATF-33143 may also be considered either for the higher linearity performance or easier circuit design for stability in the lower frequency bands (800–900 MHz).

Surface Mount Package - SOT-343

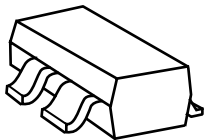

Pin Connections and Package Marking

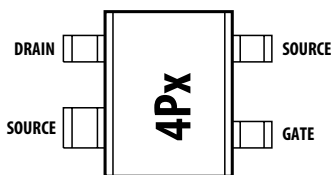

Note: Top View. Package marking provides orientation and identification.

"4P" = Device code

"x" = Date code character. A new character is assigned for each month, year.

Features

- Lead-free Option Available
- Low Noise Figure
- Excellent Uniformity in Product Specifications
- 800 micron Gate Width
- Low Cost Surface Mount Small Plastic Package SOT-343 (4 lead SC-70)
- Tape-and-Reel Packaging Option Available

Specifications

1.9 GHz; 4V, 60 mA (Typ.)

- 0.5 dB Noise Figure
- 17.5 dB Associated Gain
- 20 dBm Output Power at 1 dB Gain Compression
- 31.5 dBm Output 3rd Order Intercept

Applications

- Tower Mounted Amplifier and Low Noise Amplifier for GSM/TDMA/CDMA Base Stations
- LNA for Wireless LAN, WLL/RLL and MMDS Applications
- General Purpose Discrete PHEMT for other Ultra Low Noise Applications



Attention: Observe precautions for handling electrostatic sensitive devices.

ESD Machine Model (Class A)

ESD Human Body Model (Class 1)

Refer to Avago Application Note A004R:

Electrostatic Discharge Damage and Control.

ATF-34143 Absolute Maximum Ratings^[1]

Symbol	Parameter	Units	Absolute Maximum
V_{DS}	Drain - Source Voltage ^[2]	V	5.5
V_{GS}	Gate - Source Voltage ^[2]	V	-5
V_{GD}	Gate Drain Voltage ^[2]	V	-5
I_D	Drain Current ^[2]	mA	I_{dss} ^[3]
P_{diss}	Total Power Dissipation ^[4]	mW	725
$P_{in\ max}$	RF Input Power	dBm	17
T_{CH}	Channel Temperature	°C	160
T_{STG}	Storage Temperature	°C	-65 to 160
θ_{jc}	Thermal Resistance ^[5]	°C/W	165

Notes:

1. Operation of this device above any one of these parameters may cause permanent damage.
2. Assumes DC quiescent conditions.
3. $V_{GS} = 0$ volts.
4. Source lead temperature is 25°C. Derate 6 mW/°C for $T_L > 40$ °C.
5. Thermal resistance measured using 150°C Liquid Crystal Measurement method.
6. Under large signal conditions, V_{GS} may swing positive and the drain current may exceed I_{dss} . These conditions are acceptable as long as the maximum P_{diss} and $P_{in\ max}$ ratings are not exceeded.

Product Consistency Distribution Charts^[7]

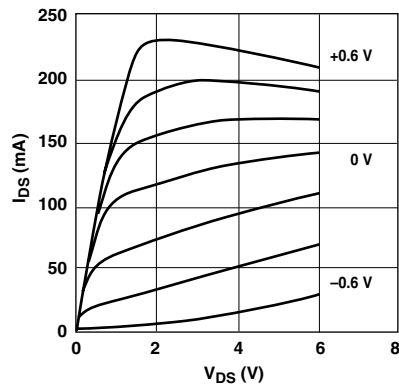

Figure 1. Typical/Pulsed I-V Curves^[6].
($V_{GS} = -0.2$ V per step)

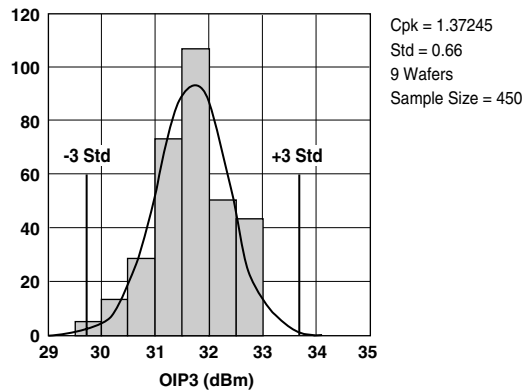

Figure 2. OIP3 @ 2 GHz, 4 V, 60 mA.
LSL=29.0, Nominal=31.8, USL=35.0

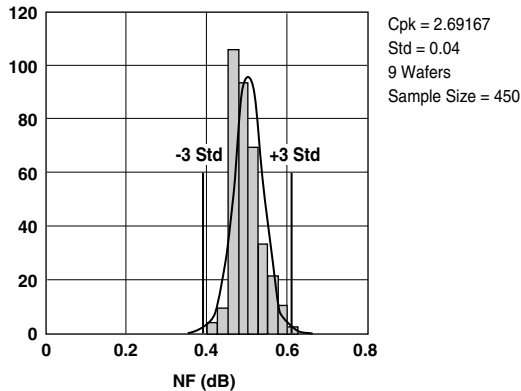

Figure 3. NF @ 2 GHz, 4 V, 60 mA.
LSL=0.1, Nominal=0.47, USL=0.8

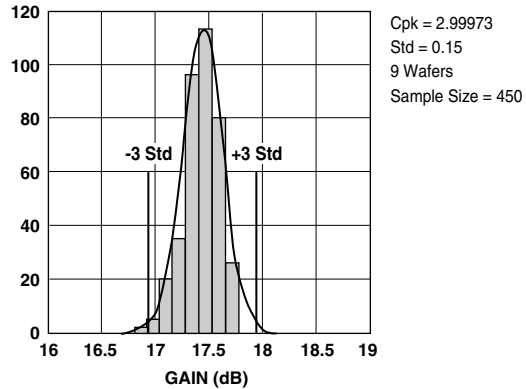

Figure 4. Gain @ 2 GHz, 4 V, 60 mA.
LSL=16.0, Nominal=17.5, USL=19.0

Notes:

7. Distribution data sample size is 450 samples taken from 9 different wafers. Future wafers allocated to this product may have nominal values anywhere within the upper and lower spec limits.
8. Measurements made on production test board. This circuit represents a trade-off between an optimal noise match and a realizable match based on production test requirements. Circuit losses have been de-embedded from actual measurements.

ATF-34143 Electrical Specifications

$T_A = 25^\circ\text{C}$, RF parameters measured in a test circuit for a typical device

Symbol	Parameters and Test Conditions	Units	Min.	Typ. ^[2]	Max.
$I_{dss}^{[1]}$	Saturated Drain Current $V_{DS} = 1.5\text{ V}, V_{GS} = 0\text{ V}$	mA	90	118	145
$V_p^{[1]}$	Pinchoff Voltage $V_{DS} = 1.5\text{ V}, I_{DS} = 10\% \text{ of } I_{dss}$	V	-0.65	-0.5	-0.35
I_d	Quiescent Bias Current $V_{GS} = -0.34\text{ V}, V_{DS} = 4\text{ V}$	mA	—	60	—
$g_m^{[1]}$	Transconductance $V_{DS} = 1.5\text{ V}, g_m = I_{dss}/V_p$	mmho	180	230	—
I_{GDO}	Gate to Drain Leakage Current $V_{GD} = 5\text{ V}$	μA			500
I_{gss}	Gate Leakage Current $V_{GD} = V_{GS} = -4\text{ V}$	μA	—	30	300
NF	Noise Figure	$f = 2\text{ GHz}$ $V_{DS} = 4\text{ V}, I_{DS} = 60\text{ mA}$ $V_{DS} = 4\text{ V}, I_{DS} = 30\text{ mA}$	dB	0.5	0.8
		$f = 900\text{ MHz}$ $V_{DS} = 4\text{ V}, I_{DS} = 60\text{ mA}$		0.5	0.4
G_a	Associated Gain	$f = 2\text{ GHz}$ $V_{DS} = 4\text{ V}, I_{DS} = 60\text{ mA}$ $V_{DS} = 4\text{ V}, I_{DS} = 30\text{ mA}$	dB	16	17.5
		$f = 900\text{ MHz}$ $V_{DS} = 4\text{ V}, I_{DS} = 60\text{ mA}$		17	19
OIP3	Output 3 rd Order Intercept Point ^[3]	$f = 2\text{ GHz}$ $+5\text{ dBm } P_{out}/\text{Tone}$ $V_{DS} = 4\text{ V}, I_{DS} = 60\text{ mA}$ $V_{DS} = 4\text{ V}, I_{DS} = 30\text{ mA}$	dBm	29	31.5
		$f = 900\text{ MHz}$ $+5\text{ dBm } P_{out}/\text{Tone}$ $V_{DS} = 4\text{ V}, I_{DS} = 60\text{ mA}$		30	31
P_{1dB}	1 dB Compressed Intercept Point ^[3]	$f = 2\text{ GHz}$ $V_{DS} = 4\text{ V}, I_{DS} = 60\text{ mA}$ $V_{DS} = 4\text{ V}, I_{DS} = 30\text{ mA}$	dBm	20	19
		$f = 900\text{ MHz}$ $V_{DS} = 4\text{ V}, I_{DS} = 60\text{ mA}$		18.5	18.5

Notes:

1. Guaranteed at wafer probe level
2. Typical value determined from a sample size of 450 parts from 9 wafers.
3. Using production test board.

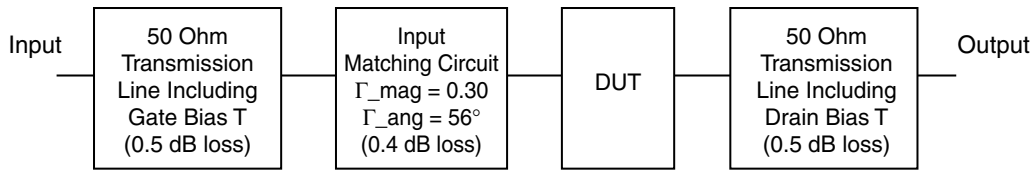

Figure 5. Block diagram of 2 GHz production test board used for Noise Figure, Associated Gain, P1dB, and OIP3 measurements. This circuit represents a trade-off between an optimal noise match and associated impedance matching circuit losses. Circuit losses have been de-embedded from actual measurements.

ATF-34143 Typical Performance Curves

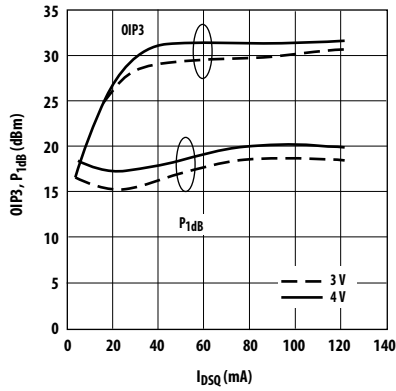

Figure 6. OIP3 and P_{1dB} vs. I_{DSQ} and V_{DS} Tuned for NF @ 4 V, 60 mA at 2 GHz. [1,2]

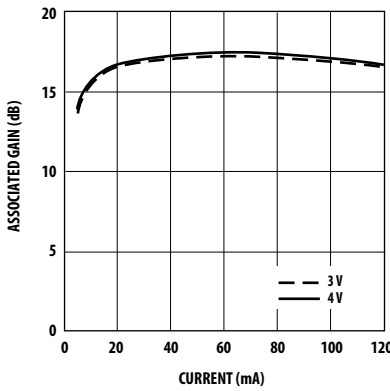

Figure 7. Associated Gain vs. Current (I_d) and Voltage (V_D) at 2 GHz. [1,2]

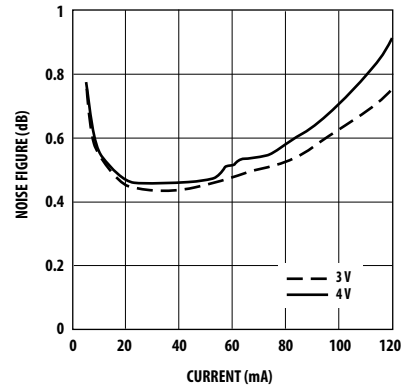

Figure 8. Noise Figure vs. Current (I_d) and Voltage (V_{DS}) at 2 GHz. [1,2]

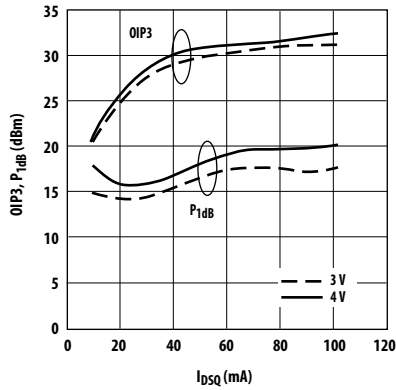

Figure 9. OIP3 and P_{1dB} vs. I_{DSQ} and V_{DS} Tuned for NF @ 4 V, 60 mA at 900 MHz. [1,2]

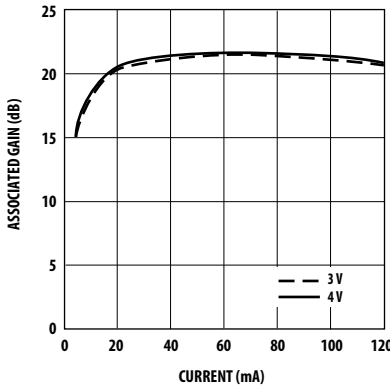

Figure 10. Associated Gain vs. Current (I_d) and Voltage (V_D) at 900 MHz. [1,2]

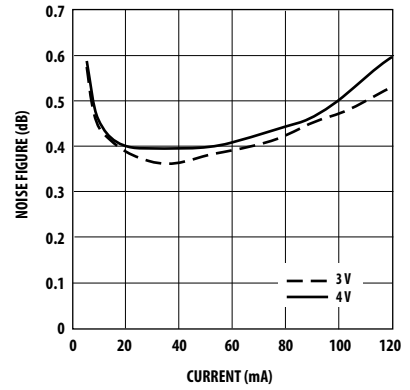

Figure 11. Noise Figure vs. Current (I_d) and Voltage (V_{DS}) at 900 MHz. [1,2]

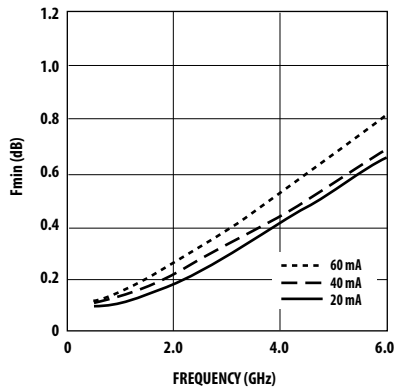

Figure 12. F_{min} vs. Frequency and Current at 4 V.

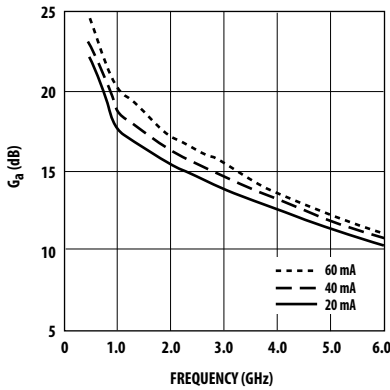

Figure 13. Associated Gain vs. Frequency and Current at 4 V.

Notes:

1. Measurements made on a fixed toned production test board that was tuned for optimal gain match with reasonable noise figure at 4V, 60 mA bias. This circuit represents a trade-off between optimal noise match, maximum gain match, and a realizable match based on production test board requirements. Circuit losses have been de-embedded from actual measurements.
2. P_{1dB} measurements are performed with passive biasing. Quiescent drain current, I_{DSQ} , is set with zero RF drive applied. As P_{1dB} is approached, the drain current may increase or decrease depending on frequency and dc bias point. At lower values of I_{DSQ} the device is running closer to class B as power output approaches P_{1dB} . This results in higher PAE (power added efficiency) when compared to a device that is driven by a constant current source as is typically done with active biasing. As an example, at a $V_{DS} = 4$ V and $I_{DSQ} = 10$ mA, I_d increases to 62 mA as a P_{1dB} of +19 dBm is approached.

ATF-34143 Typical Performance Curves, continued

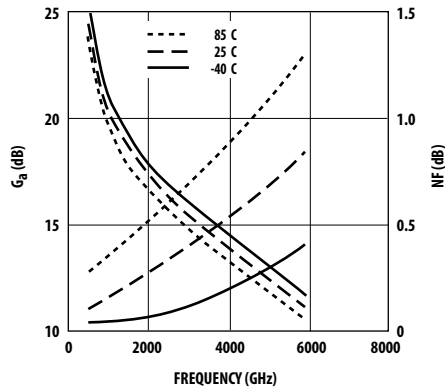

Figure 14. F_{min} and G_a vs. Frequency and Temperature at $V_{DS} = 4V$, $I_{DS} = 60$ mA.

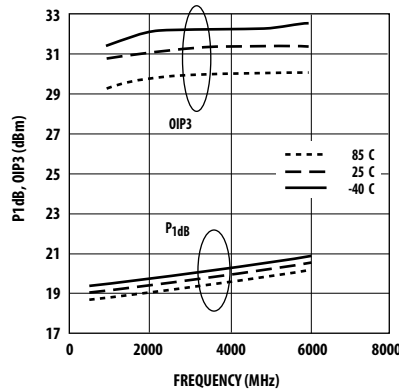

Figure 15. P_{1dB} , $IP3$ vs. Frequency and Temperature at $V_{DS} = 4V$, $I_{DS} = 60$ mA. [1]

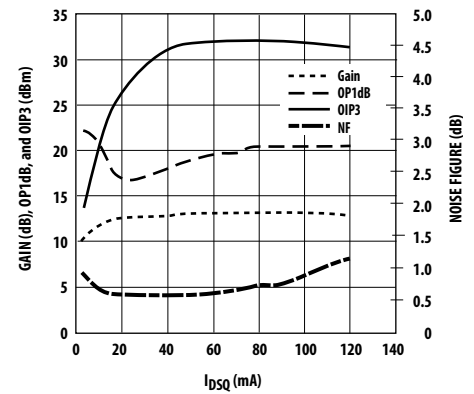

Figure 16. NF, Gain, OP1dB and OIP3 vs. I_{DSQ} at 4 V and 3.9 GHz Tuned for Noise Figure. [1]

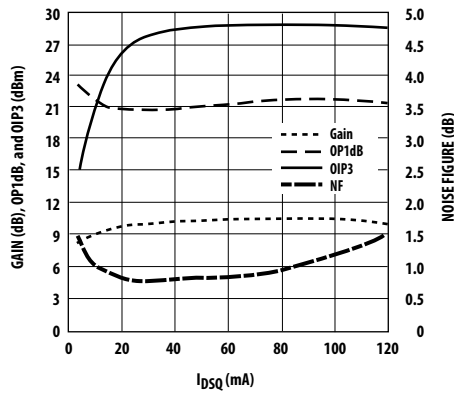

Figure 17. NF, Gain, OP1dB and OIP3 vs. I_{DSQ} at 4 V and 5.8 GHz Tuned for Noise Figure. [1]

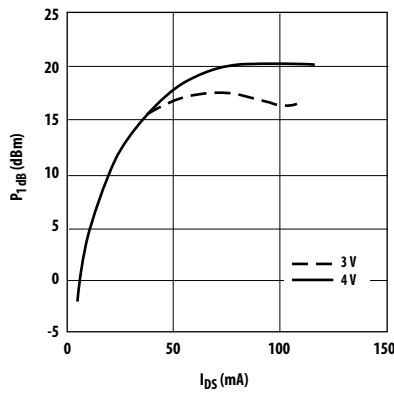

Figure 18. P_{1dB} vs. I_{DS} Active Bias Tuned for NF @ 4V, 60 mA at 2 GHz.

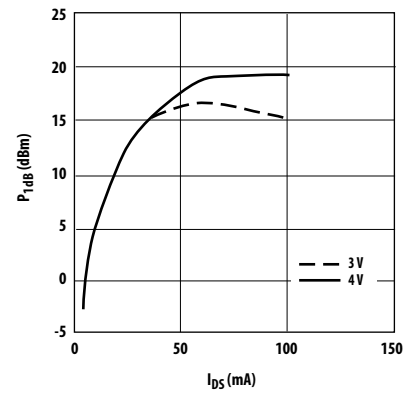

Figure 19. P_{1dB} vs. I_{DS} Active Bias Tuned for min NF @ 4V, 60 mA at 900 MHz.

Note:

- P_{1dB} measurements are performed with passive biasing. Quiescent drain current, I_{DSQ} , is set with zero RF drive applied. As P_{1dB} is approached, the drain current may increase or decrease depending on frequency and dc bias point. At lower values of I_{DSQ} the device is running closer to class B as power output approaches P_{1dB} . This results in higher PAE (power added efficiency) when compared to a device that is driven by a constant current source as is typically done with active biasing. As an example, at a $V_{DS} = 4V$ and $I_{DSQ} = 10$ mA, I_d increases to 62 mA as a P_{1dB} of +19 dBm is approached.

ATF-34143 Power Parameters tuned for Power, $V_{DS} = 4\text{ V}$, $I_{DSQ} = 120\text{ mA}$

Freq (GHz)	P_{1dB} (dBm)	I_d (mA)	G_{1dB} (dB)	PAE_{1dB} (%)	P_{3dBm} (dBm)	I_d (mA)	PAE_{3dB} (%)	Gamma Out_mag (Mag)	Gamma Out_ang (Degrees)
0.9	20.9	114	25.7	27	22.8	108	44	0.34	136
1.5	21.7	115	21.9	32	23.1	95	53	0.31	152
1.8	21.3	111	20.5	30	23.0	105	47	0.30	164
2	22.0	106	19.5	37	23.7	115	50	0.28	171
4	22.7	110	12.7	40	23.6	111	47	0.26	-135
6	23.3	115	9.2	41	24.2	121	44	0.24	-66

ATF-34143 Power Parameters tuned for Power, $V_{DS} = 4\text{ V}$, $I_{DSQ} = 60\text{ mA}$

Freq (GHz)	P_{1dB} (dBm)	I_d (mA)	G_{1dB} (dB)	PAE_{1dB} (%)	P_{3dBm} (dBm)	I_d (mA)	PAE_{3dB} (%)	Gamma Out_mag (Mag)	Gamma Out_ang (Degrees)
0.9	18.2	75	27.5	22	20.5	78	36	0.48	102
1.5	18.7	58	24.5	32	20.8	59	51	0.45	117
1.8	18.8	57	23.0	33	21.1	71	45	0.42	126
2	18.8	59	22.2	32	21.9	81	47	0.40	131
4	20.2	66	13.9	38	22.0	77	48	0.25	-162
6	21.2	79	9.9	37	23.5	102	46	0.18	-77

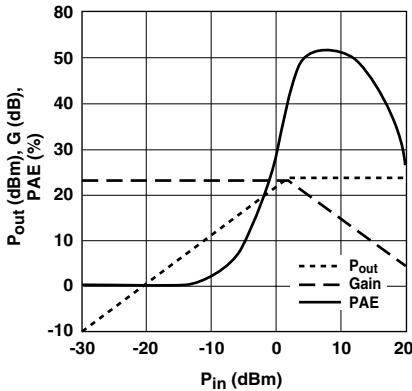

Figure 20. Swept Power Tuned for Power at 2 GHz, $V_{DS} = 4\text{ V}$, $I_{DSQ} = 120\text{ mA}$.

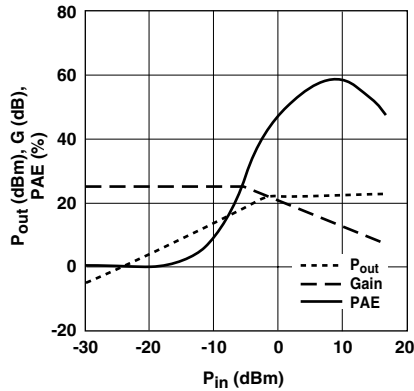

Figure 21. Swept Power Tuned for Power at 2 GHz, $V_{DS} = 4\text{ V}$, $I_{DSQ} = 60\text{ mA}$.

Notes:

- P_{1dB} measurements are performed with passive biasing. Quiescent drain current, I_{DSQ} is set with zero RF drive applied. As P_{1dB} is approached, the drain current may increase or decrease depending on frequency and dc bias point. At lower values of I_{DSQ} the device is running closer to class B as power output approaches P_{1dB} . This results in higher PAE (power added efficiency) when compared to a device that is driven by a constant current source as is typically done with active biasing. As an example, at a $V_{DS} = 4\text{ V}$ and $I_{DSQ} = 10\text{ mA}$, I_d increases to 62 mA as a P_{1dB} of +19 dBm is approached.
- $PAE(\%) = ((P_{out} - P_{in})/P_{dc}) \times 100$
- Gamma out is the reflection coefficient of the matching circuit presented to the output of the device.

ATF-34143 Typical Scattering Parameters, $V_{DS} = 3\text{ V}$, $I_{DS} = 20\text{ mA}$

Freq. GHz	S_{11}			S_{21}			S_{12}			S_{22}			MSG/MAG dB
	Mag.	Ang.	dB	Mag.	Ang.	dB	Mag.	Ang.	Mag.	Ang.	Mag.	Ang.	
0.5	0.96	-37	20.07	10.079	153	-29.12	0.035	68	0.40	-35	24.59		
0.8	0.91	-60	19.68	9.642	137	-26.02	0.050	56	0.34	-56	22.85		
1.0	0.87	-76	18.96	8.867	126	-24.29	0.061	48	0.32	-71	21.62		
1.5	0.81	-104	17.43	7.443	106	-22.27	0.077	34	0.29	-98	19.85		
1.8	0.78	-115	16.70	6.843	98	-21.62	0.083	28	0.28	-110	19.16		
2.0	0.75	-126	16.00	6.306	90	-21.11	0.088	23	0.26	-120	18.55		
2.5	0.72	-145	14.71	5.438	75	-20.45	0.095	15	0.25	-140	17.58		
3.0	0.69	-162	13.56	4.762	62	-19.83	0.102	7	0.23	-156	16.69		
4.0	0.65	166	11.61	3.806	38	-19.09	0.111	-8	0.22	174	15.35		
5.0	0.64	139	10.01	3.165	16	-18.49	0.119	-21	0.22	146	14.25		
6.0	0.65	114	8.65	2.706	-5	-18.06	0.125	-35	0.23	118	13.35		
7.0	0.66	89	7.33	2.326	-27	-17.79	0.129	-49	0.25	91	10.91		
8.0	0.69	67	6.09	2.017	-47	-17.52	0.133	-62	0.29	67	9.71		
9.0	0.72	48	4.90	1.758	-66	-17.39	0.135	-75	0.34	46	8.79		
10.0	0.75	30	3.91	1.568	-86	-17.08	0.140	-88	0.39	28	8.31		
11.0	0.77	10	2.88	1.393	-105	-16.95	0.142	-103	0.43	10	7.56		
12.0	0.80	-10	1.74	1.222	-126	-16.95	0.142	-118	0.47	-10	6.83		
13.0	0.83	-29	0.38	1.045	-145	-17.39	0.135	-133	0.53	-28	6.18		
14.0	0.85	-44	-0.96	0.895	-161	-17.86	0.128	-145	0.58	-42	5.62		
15.0	0.86	-55	-2.06	0.789	-177	-18.13	0.124	-156	0.62	-57	5.04		
16.0	0.85	-72	-3.09	0.701	166	-18.13	0.124	-168	0.65	-70	3.86		
17.0	0.85	-88	-4.22	0.615	149	-18.06	0.125	177	0.68	-85	3.00		
18.0	0.88	-101	-5.71	0.518	133	-18.94	0.113	165	0.71	-103	2.52		

ATF-34143 Typical Noise Parameters

$V_{DS} = 3\text{ V}$, $I_{DS} = 20\text{ mA}$

Freq. GHz	F_{min} dB	Γ_{opt}		$R_{n/50}$ -	G_a dB
		Mag.	Ang.		
0.5	0.10	0.90	13	0.16	21.8
0.9	0.11	0.85	27	0.14	18.3
1.0	0.11	0.84	31	0.13	17.8
1.5	0.14	0.77	48	0.11	16.4
1.8	0.17	0.74	57	0.10	16.0
2.0	0.19	0.71	66	0.09	15.6
2.5	0.23	0.65	83	0.07	14.8
3.0	0.29	0.59	102	0.06	14.0
4.0	0.42	0.51	138	0.03	12.6
5.0	0.54	0.45	174	0.03	11.4
6.0	0.67	0.42	-151	0.05	10.3
7.0	0.79	0.42	-118	0.10	9.4
8.0	0.92	0.45	-88	0.18	8.6
9.0	1.04	0.51	-63	0.30	8.0
10.0	1.16	0.61	-43	0.46	7.5

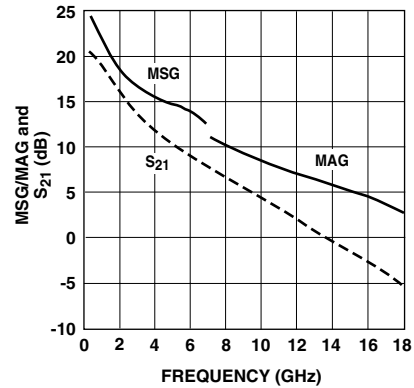

Figure 23. MSG/MAG and $|S_{21}|^2$ vs. Frequency at 3 V, 20 mA.

Notes:

1. F_{min} values at 2 GHz and higher are based on measurements while the F_{min} s below 2 GHz have been extrapolated. The F_{min} values are based on a set of 16 noise figure measurements made at 16 different impedances using an ATN NP5 test system. From these measurements a true F_{min} is calculated. Refer to the noise parameter application section for more information.
2. S and noise parameters are measured on a microstrip line made on 0.025 inch thick alumina carrier. The input reference plane is at the end of the gate lead. The output reference plane is at the end of the drain lead. The parameters include the effect of four plated through via holes connecting source landing pads on top of the test carrier to the microstrip ground plane on the bottom side of the carrier. Two 0.020 inch diameter via holes are placed within 0.010 inch from each source lead contact point, one via on each side of that point.

ATF-34143 Typical Scattering Parameters, $V_{DS} = 3\text{ V}$, $I_{DS} = 40\text{ mA}$

Freq. GHz	S_{11}			S_{21}			S_{12}		S_{22}		MSG/MAG dB
	Mag.	Ang.	dB	Mag.	Ang.	dB	Mag.	Ang.	Mag.	Ang.	
0.5	0.96	-40	21.32	11.645	151	-30.46	0.030	68	0.29	-43	25.89
0.8	0.89	-64	20.79	10.950	135	-27.33	0.043	56	0.24	-70	24.06
1.0	0.85	-81	19.96	9.956	124	-25.68	0.052	49	0.24	-88	22.82
1.5	0.79	-109	18.29	8.209	104	-23.61	0.066	36	0.23	-118	20.95
1.8	0.76	-121	17.50	7.495	96	-22.97	0.071	32	0.23	-130	20.24
2.0	0.74	-131	16.75	6.876	88	-22.38	0.076	27	0.22	-141	19.57
2.5	0.70	-150	15.39	5.880	74	-21.51	0.084	19	0.22	-160	18.45
3.0	0.67	-167	14.19	5.120	61	-20.92	0.090	12	0.22	-176	17.55
4.0	0.64	162	12.18	4.063	38	-19.83	0.102	-1	0.21	157	16.00
5.0	0.64	135	10.54	3.365	16	-19.02	0.112	-14	0.22	131	14.78
6.0	0.65	111	9.15	2.867	-5	-18.34	0.121	-28	0.24	105	12.91
7.0	0.66	87	7.80	2.454	-26	-17.86	0.128	-42	0.28	81	11.03
8.0	0.69	65	6.55	2.125	-46	-17.46	0.134	-55	0.32	60	9.93
9.0	0.73	46	5.33	1.848	-65	-17.20	0.138	-69	0.37	40	9.07
10.0	0.76	28	4.33	1.647	-84	-16.83	0.144	-84	0.41	23	8.59
11.0	0.78	9	3.30	1.462	-104	-16.65	0.147	-99	0.45	5	7.84
12.0	0.80	-11	2.15	1.281	-123	-16.65	0.147	-114	0.50	-14	7.15
13.0	0.83	-30	0.79	1.095	-142	-17.08	0.140	-130	0.55	-31	6.50
14.0	0.86	-44	-0.53	0.941	-158	-17.52	0.133	-142	0.60	-45	5.96
15.0	0.87	-56	-1.61	0.831	-174	-17.72	0.130	-154	0.64	-59	5.39
16.0	0.86	-72	-2.60	0.741	169	-17.72	0.130	-166	0.66	-73	4.21
17.0	0.86	-88	-3.72	0.652	153	-17.79	0.129	179	0.69	-88	3.43
18.0	0.88	-102	-5.15	0.553	137	-18.64	0.117	166	0.72	-105	2.95

ATF-34143 Typical Noise Parameters

$V_{DS} = 3\text{ V}$, $I_{DS} = 40\text{ mA}$

Freq. GHz	F_{min} dB	Γ_{opt}		$R_{n/50}$ -	G_a dB
		Mag.	Ang.		
0.5	0.10	0.87	13	0.16	23.0
0.9	0.13	0.82	28	0.13	19.6
1.0	0.14	0.80	32	0.13	19.2
1.5	0.17	0.73	50	0.1	17.7
1.8	0.21	0.70	61	0.09	17.1
2.0	0.23	0.66	68	0.08	16.7
2.5	0.29	0.60	87	0.06	15.8
3.0	0.35	0.54	106	0.05	14.9
4.0	0.47	0.46	144	0.03	13.4
5.0	0.6	0.41	-178	0.03	12.1
6.0	0.72	0.39	-142	0.06	10.9
7.0	0.85	0.41	-109	0.12	9.9
8.0	0.97	0.45	-80	0.21	9.1
9.0	1.09	0.52	-56	0.34	8.4
10.0	1.22	0.61	-39	0.50	8.0

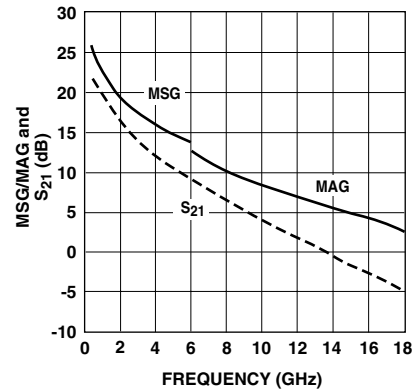

Figure 24. MSG/MAG and $|S_{21}|^2$ vs. Frequency at 3 V, 40 mA.

Notes:

1. F_{min} values at 2 GHz and higher are based on measurements while the F_{min} s below 2 GHz have been extrapolated. The F_{min} values are based on a set of 16 noise figure measurements made at 16 different impedances using an ATN NP5 test system. From these measurements a true F_{min} is calculated. Refer to the noise parameter application section for more information.
2. S and noise parameters are measured on a microstrip line made on 0.025 inch thick alumina carrier. The input reference plane is at the end of the gate lead. The output reference plane is at the end of the drain lead. The parameters include the effect of four plated through via holes connecting source landing pads on top of the test carrier to the microstrip ground plane on the bottom side of the carrier. Two 0.020 inch diameter via holes are placed within 0.010 inch from each source lead contact point, one via on each side of that point.

ATF-34143 Typical Scattering Parameters, $V_{DS} = 4\text{ V}$, $I_{DS} = 40\text{ mA}$

Freq. GHz	S_{11}			S_{21}			S_{12}			S_{22}		MSG/MAG dB
	Mag.	Ang.	dB	Mag.	Ang.	dB	Mag.	Ang.	Mag.	Ang.		
0.5	0.95	-40	21.56	11.973	151	0.03	0.030	68	0.33	-39	26.01	
0.8	0.89	-65	21.02	11.252	135	0.04	0.042	56	0.27	-63	24.28	
1.0	0.85	-82	20.19	10.217	123	0.05	0.051	48	0.26	-80	23.02	
1.5	0.78	-109	18.49	8.405	104	0.06	0.064	36	0.24	-109	21.18	
1.8	0.73	-131	16.93	7.024	87	0.07	0.074	27	0.22	-131	20.46	
2.0	0.70	-150	15.57	6.002	73	0.08	0.081	19	0.21	-150	19.77	
2.5	0.67	-167	14.36	5.223	61	0.09	0.087	12	0.20	-167	18.70	
3.0	0.64	162	12.34	4.141	37	0.10	0.098	-1	0.19	165	17.75	
4.0	0.63	135	10.70	3.428	16	0.11	0.108	-13	0.20	138	16.26	
5.0	0.64	111	9.32	2.923	-6	0.12	0.117	-27	0.21	111	15.02	
6.0	0.66	87	7.98	2.506	-26	0.12	0.124	-41	0.24	86	12.93	
7.0	0.69	65	6.74	2.173	-46	0.13	0.130	-54	0.29	63	11.14	
8.0	0.72	47	5.55	1.894	-65	0.13	0.134	-68	0.34	42	10.09	
9.0	0.76	28	4.55	1.689	-85	0.14	0.141	-82	0.38	26	9.24	
10.0	0.78	9	3.53	1.501	-104	0.15	0.145	-97	0.42	8	8.79	
11.0	0.80	-11	2.39	1.317	-124	0.15	0.145	-113	0.47	-11	8.09	
12.0	0.84	-29	1.02	1.125	-143	0.14	0.140	-128	0.53	-29	7.35	
13.0	0.86	-44	-0.30	0.966	-160	0.13	0.133	-141	0.58	-43	6.76	
14.0	0.87	-56	-1.38	0.853	-176	0.13	0.130	-152	0.62	-58	6.19	
15.0	0.86	-72	-2.40	0.759	167	0.13	0.131	-165	0.65	-71	5.62	
16.0	0.86	-88	-3.53	0.666	151	0.13	0.130	-180	0.68	-86	4.43	
17.0	0.89	-102	-4.99	0.563	134	0.12	0.119	168	0.71	-103	3.60	
18.0	0.89	-101.85	-4.99	0.563	134	0.12	0.119	168	0.71	-103	3.15	

ATF-34143 Typical Noise Parameters

$V_{DS} = 4\text{ V}$, $I_{DS} = 40\text{ mA}$

Freq. GHz	F_{min} dB	Γ_{opt}		$R_{n/50}$ -	G_a dB
		Mag.	Ang.		
0.5	0.10	0.87	13	0.16	22.8
0.9	0.13	0.82	27	0.14	19.4
1.0	0.14	0.80	31	0.13	18.9
1.5	0.17	0.73	49	0.11	17.4
1.8	0.20	0.70	60	0.10	16.9
2.0	0.22	0.66	67	0.09	16.4
2.5	0.28	0.60	85	0.07	15.6
3.0	0.34	0.54	104	0.05	14.8
4.0	0.45	0.45	142	0.03	13.3
5.0	0.57	0.40	180	0.03	12.0
6.0	0.69	0.38	-144	0.05	10.9
7.0	0.81	0.39	-111	0.11	9.9
8.0	0.94	0.43	-82	0.20	9.1
9.0	1.06	0.51	-57	0.32	8.5
10.0	1.19	0.62	-40	0.47	8.1

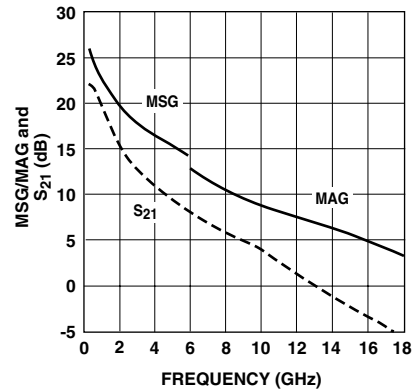

Figure 25. MSG/MAG and $|S_{21}|^2$ vs. Frequency at 4 V, 40 mA.

Notes:

1. F_{min} values at 2 GHz and higher are based on measurements while the F_{min} s below 2 GHz have been extrapolated. The F_{min} values are based on a set of 16 noise figure measurements made at 16 different impedances using an ATN NP5 test system. From these measurements a true F_{min} is calculated. Refer to the noise parameter application section for more information.
2. S and noise parameters are measured on a microstrip line made on 0.025 inch thick alumina carrier. The input reference plane is at the end of the gate lead. The output reference plane is at the end of the drain lead. The parameters include the effect of four plated through via holes connecting source landing pads on top of the test carrier to the microstrip ground plane on the bottom side of the carrier. Two 0.020 inch diameter via holes are placed within 0.010 inch from each source lead contact point, one via on each side of that point.

ATF-34143 Typical Scattering Parameters, $V_{DS} = 4\text{ V}$, $I_{DS} = 60\text{ mA}$

Freq. GHz	S_{11}			S_{21}			S_{12}			S_{22}		MSG/MAG dB
	Mag.	Ang.	dB	Mag.	Ang.	dB	Mag.	Ang.	Mag.	Ang.		
0.5	0.95	-41	21.91	12.454	150	-31.06	0.028	68	0.29	-41	26.48	
0.8	0.89	-65	21.33	11.654	134	-28.18	0.039	57	0.24	-67	24.75	
1.0	0.85	-83	20.46	10.549	123	-26.56	0.047	49	0.23	-84	23.51	
1.5	0.78	-111	18.74	8.646	103	-24.44	0.060	38	0.21	-114	21.59	
1.8	0.75	-122	17.92	7.873	95	-23.74	0.065	33	0.21	-125	20.83	
2.0	0.73	-133	17.16	7.207	87	-23.22	0.069	29	0.20	-136	20.19	
2.5	0.69	-151	15.78	6.149	73	-22.38	0.076	22	0.19	-155	19.08	
3.0	0.67	-168	14.56	5.345	60	-21.62	0.083	15	0.19	-171	18.09	
4.0	0.64	161	12.53	4.232	37	-20.54	0.094	3	0.18	162	16.53	
5.0	0.63	134	10.88	3.501	16	-19.58	0.105	-10	0.19	135	15.23	
6.0	0.64	111	9.49	2.983	-5	-18.79	0.115	-24	0.21	109	12.89	
7.0	0.66	86	8.15	2.557	-26	-18.27	0.122	-38	0.24	84	11.22	
8.0	0.69	65	6.92	2.217	-46	-17.79	0.129	-51	0.28	62	10.21	
9.0	0.73	46	5.72	1.932	-65	-17.46	0.134	-65	0.33	42	9.36	
10.0	0.76	28	4.73	1.723	-84	-16.95	0.142	-79	0.38	25	8.94	
11.0	0.78	9	3.70	1.531	-104	-16.71	0.146	-94	0.42	7	8.23	
12.0	0.81	-11	2.57	1.344	-124	-16.71	0.146	-111	0.47	-12	7.56	
13.0	0.84	-30	1.20	1.148	-143	-17.02	0.141	-126	0.52	-29	6.94	
14.0	0.86	-44	-0.12	0.986	-159	-17.46	0.134	-139	0.58	-43	6.37	
15.0	0.87	-56	-1.21	0.870	-175	-17.59	0.132	-150	0.62	-58	5.78	
16.0	0.86	-72	-2.21	0.775	168	-17.59	0.132	-163	0.65	-71	4.60	
17.0	0.86	-88	-3.35	0.680	151	-17.65	0.131	-178	0.68	-86	3.79	
18.0	0.89	-101.99	-4.81	0.575	135	-18.42	0.120	169	0.71	-104	3.33	

ATF-34143 Typical Noise Parameters

$V_{DS} = 4\text{ V}$, $I_{DS} = 60\text{ mA}$

Freq. GHz	F_{min} dB	Γ_{opt}		$R_{n/50}$ -	G_a dB
		Mag.	Ang.		
0.5	0.11	0.84	15	0.14	24.5
0.9	0.14	0.78	30	0.12	20.7
1.0	0.15	0.77	34	0.12	20.2
1.5	0.20	0.69	53	0.10	18.5
1.8	0.23	0.66	62	0.10	17.7
2.0	0.26	0.62	72	0.09	17.2
2.5	0.33	0.55	91	0.07	16.3
3.0	0.39	0.50	111	0.05	15.4
4.0	0.53	0.43	149	0.03	13.7
5.0	0.67	0.39	-173	0.04	12.3
6.0	0.81	0.39	-137	0.07	11.1
7.0	0.96	0.42	-104	0.14	10.0
8.0	1.10	0.47	-76	0.26	9.2
9.0	1.25	0.54	-53	0.41	8.6
10.0	1.39	0.62	-37	0.60	8.2

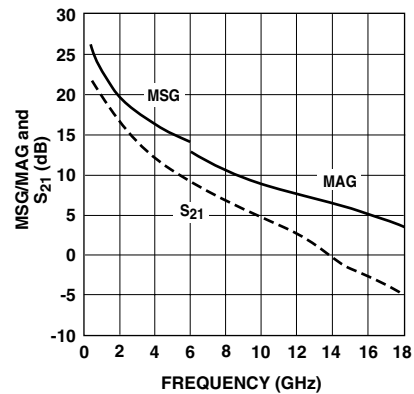

Figure 26. MSG/MAG and $|S_{21}|^2$ vs. Frequency at 4 V, 60 mA.

Notes:

1. Fmin values at 2 GHz and higher are based on measurements while the Fmins below 2 GHz have been extrapolated. The Fmin values are based on a set of 16 noise figure measurements made at 16 different impedances using an ATN NP5 test system. From these measurements a true Fmin is calculated. Refer to the noise parameter application section for more information.
2. S and noise parameters are measured on a microstrip line made on 0.025 inch thick alumina carrier. The input reference plane is at the end of the gate lead. The output reference plane is at the end of the drain lead. The parameters include the effect of four plated through via holes connecting source landing pads on top of the test carrier to the microstrip ground plane on the bottom side of the carrier. Two 0.020 inch diameter via holes are placed within 0.010 inch from each source lead contact point, one via on each side of that point.

Noise Parameter Applications Information

F_{min} values at 2 GHz and higher are based on measurements while the F_{mins} below 2 GHz have been extrapolated. The F_{min} values are based on a set of 16 noise figure measurements made at 16 different impedances using an ATN NP5 test system. From these measurements, a true F_{min} is calculated. F_{min} represents the true minimum noise figure of the device when the device is presented with an impedance matching network that transforms the source impedance, typically 50Ω , to an impedance represented by the reflection coefficient Γ_o . The designer must design a matching network that will present Γ_o to the device with minimal associated circuit losses. The noise figure of the completed amplifier is equal to the noise figure of the device plus the losses of the matching network preceding the device. The noise figure of the device is equal to F_{min} only when the device is presented with Γ_o . If the reflection coefficient of the matching network is other than Γ_o , then the noise figure of the device will be greater than F_{min} based on the following equation.

$$NF = F_{min} + 4 \frac{R_n}{Z_o} \frac{|\Gamma_s - \Gamma_o|^2}{(1 + |\Gamma_o|^2)(1 - |\Gamma_s|^2)}$$

Where R_n/Z_o is the normalized noise resistance, Γ_o is the optimum reflection coefficient required to produce F_{min} and Γ_s is the reflection coefficient of the source impedance actually presented to the device. The losses of the matching networks are non-zero and they will also add

to the noise figure of the device creating a higher amplifier noise figure. The losses of the matching networks are related to the Q of the components and associated printed circuit board loss. Γ_o is typically fairly low at higher frequencies and increases as frequency is lowered. Larger gate width devices will typically have a lower Γ_o as compared to narrower gate width devices.

Typically for FETs, the higher Γ_o usually infers that an impedance much higher than 50Ω is required for the device to produce F_{min} . At VHF frequencies and even lower L Band frequencies, the required impedance can be in the vicinity of several thousand ohms. Matching to such a high impedance requires very hi-Q components in order to minimize circuit losses. As an example at 900 MHz, when airwound coils ($Q > 100$) are used for matching networks, the loss can still be up to 0.25 dB which will add directly to the noise figure of the device. Using multilayer molded inductors with Qs in the 30 to 50 range results in additional loss over the airwound coil. Losses as high as 0.5 dB or greater add to the typical 0.15 dB F_{min} of the device creating an amplifier noise figure of nearly 0.65 dB. A discussion concerning calculated and measured circuit losses and their effect on amplifier noise figure is covered in Avago Application 1085.

**ATF-34143 SC-70 4 Lead, High Frequency Nonlinear Model
Optimized for 0.1–6.0 GHz**

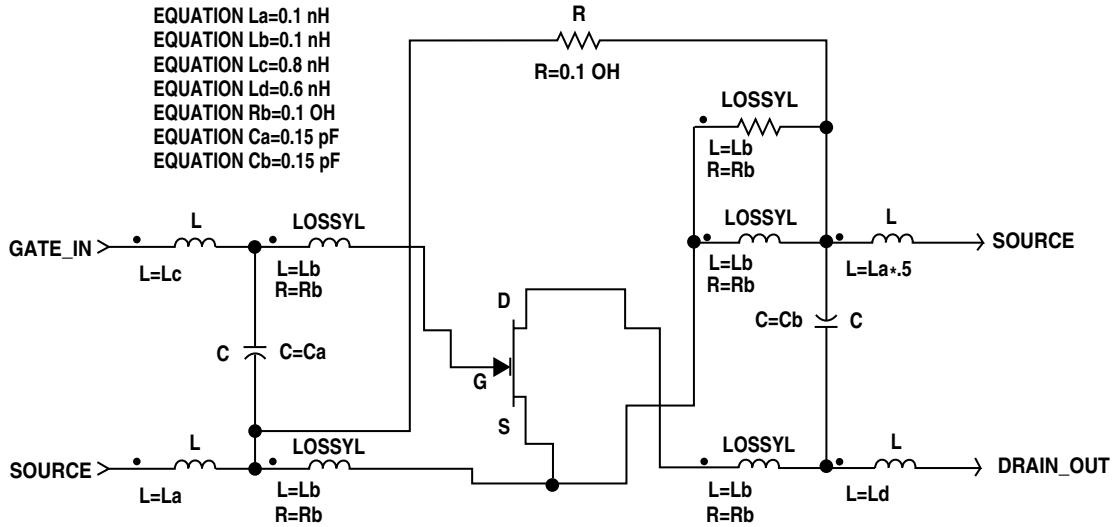

This model can be used as a design tool. It has been tested on MDS for various specifications. However, for more precise and accurate design, please refer to the measured

data in this data sheet. For future improvements Avago reserves the right to change these models without prior notice.

ATF-34143 Die Model

* STATZ MESFET MODEL *				
MODEL = FET				
IDS model	Gate model	Parasitics	Breakdown	Noise
NFET=yes	DELTA=.2	RG=1	GSFWD=1	FNC=01e+6
PFET=	GSCAP=3	RD=Rd	GSREV=0	R=.17
IDSMOD=3	CGS=cgs pF	RS=Rs	GDFWD=1	P=.65
VTO=-0.95	VTO=-0.95	LG=Lg nH	GDREV=0	C=.2
BETA= Beta	GCD=Cgd pF	LD=Ld nH	VJR=1	
LAMBDA=0.09		LS=Ls nH	IS=1 nA	
ALPHA=4.0		CDS=Cds pF	IR=1 nA	
B=0.8		CRF=.1	IMAX=.1	
TNOM=27		RC=Rc	XTI=	
IDSTC=			N=	
VBI=.7			EG=	

Model scal factors (W=FET width in microns)

- EQUATION Cds=0.01*W/200
- EQUATION Beta=0.06*W/200
- EQUATION Rd=200/W
- EQUATION Rs=.5*200/W
- EQUATION Cgs=0.2*W/200
- EQUATION Cgd=0.04*W/200
- EQUATION Lg=0.03*200/W
- EQUATION Ld=0.03*200/W
- EQUATION Ls=0.01*200/W
- EQUATION Rc=500*200/W

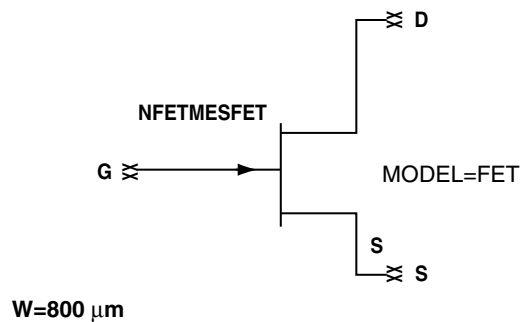

Part Number Ordering Information

Part Number	No. of Devices	Container
ATF-34143-TR1G	3000	7" Reel
ATF-34143-TR2G	10000	13" Reel
ATF-34143-BLKG	100	antistatic bag

Package Dimensions

SC-70 4L/SOT-343

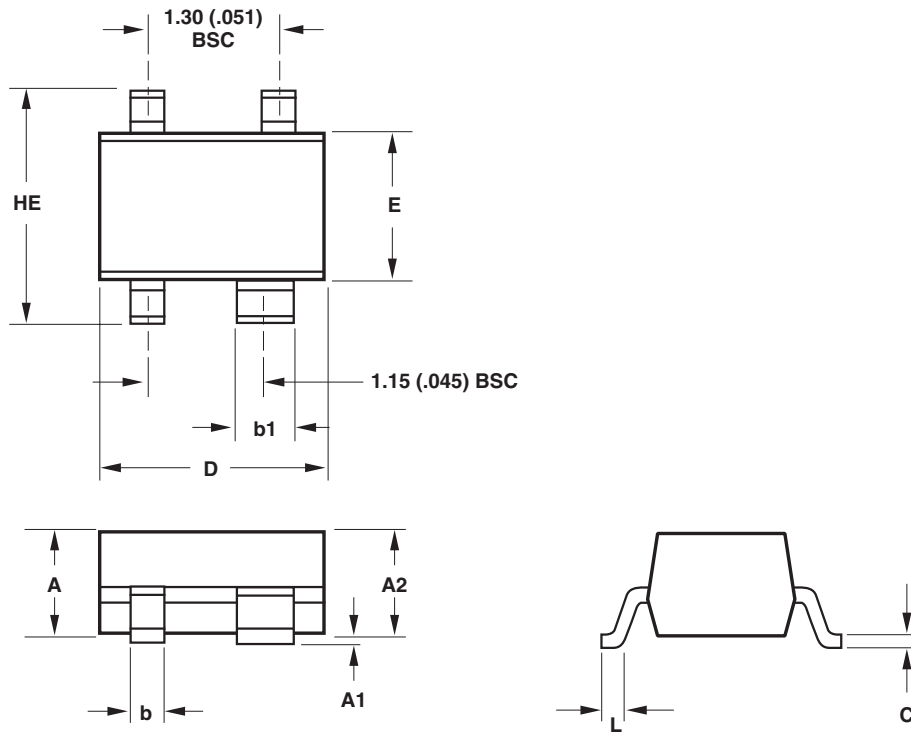

SYMBOL	DIMENSIONS (mm)	
	MIN.	MAX.
E	1.15	1.35
D	1.85	2.25
HE	1.80	2.40
A	0.80	1.10
A2	0.80	1.00
A1	0.00	0.10
b	0.25	0.40
b1	0.55	0.70
c	0.10	0.20
L	0.10	0.46

NOTES:

1. All dimensions are in mm.
2. Dimensions are inclusive of plating.
3. Dimensions are exclusive of mold flash & metal burr.
4. All specifications comply to EIAJ SC70.
5. Die is facing up for mold and facing down for trim/form, ie: reverse trim/form.
6. Package surface to be mirror finish.

**Recommended PCB Pad Layout for
Avago's SC70 4L/SOT-343 Products**

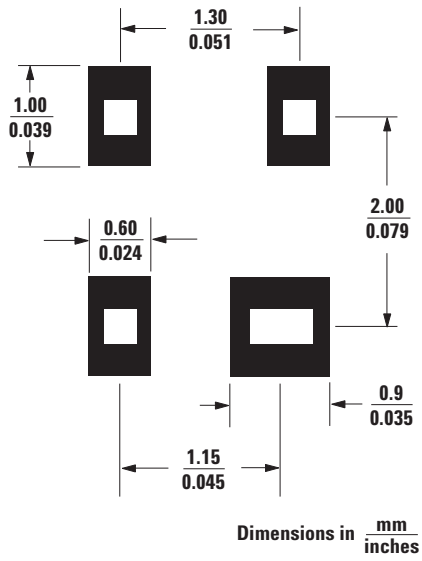

Device Orientation

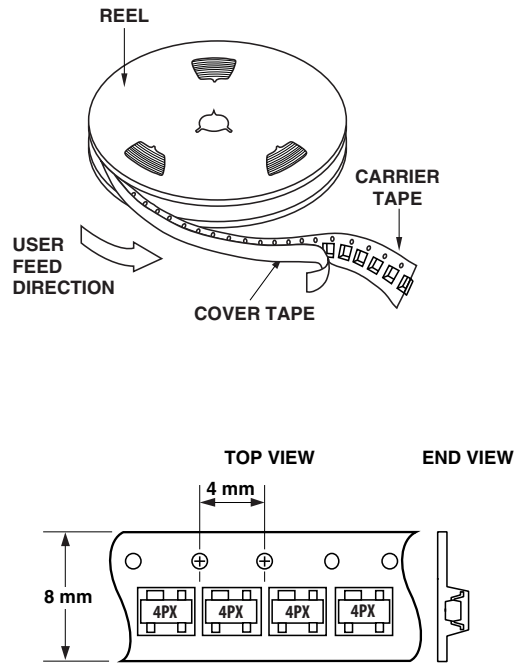

Tape Dimensions and Product Orientation

For Outline 4T

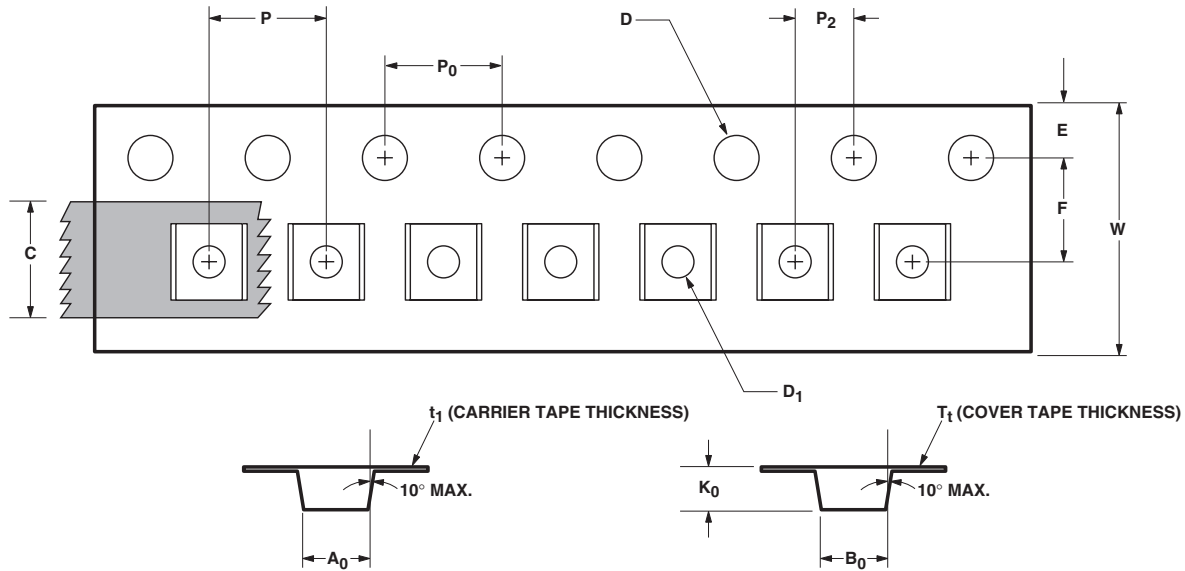

DESCRIPTION		SYMBOL	SIZE (mm)	SIZE (INCHES)
CAVITY	LENGTH	A_0	2.40 ± 0.10	0.094 ± 0.004
	WIDTH	B_0	2.40 ± 0.10	0.094 ± 0.004
	DEPTH	K_0	1.20 ± 0.10	0.047 ± 0.004
	PITCH	P	4.00 ± 0.10	0.157 ± 0.004
	BOTTOM HOLE DIAMETER	D_1	$1.00 + 0.25$	$0.039 + 0.010$
	PERFORATION	DIAMETER	D	1.55 ± 0.10
	PITCH	P_0	4.00 ± 0.10	0.157 ± 0.004
	POSITION	E	1.75 ± 0.10	0.069 ± 0.004
CARRIER TAPE	WIDTH	W	$8.00 + 0.30 - 0.10$	$0.315 + 0.012$
	THICKNESS	t_1	0.254 ± 0.02	0.0100 ± 0.0008
COVER TAPE	WIDTH	C	5.40 ± 0.10	$0.205 + 0.004$
	TAPE THICKNESS	T_t	0.062 ± 0.001	0.0025 ± 0.0004
DISTANCE	CAVITY TO PERFORATION (WIDTH DIRECTION)	F	3.50 ± 0.05	0.138 ± 0.002
	CAVITY TO PERFORATION (LENGTH DIRECTION)	P_2	2.00 ± 0.05	0.079 ± 0.002

For product information and a complete list of distributors, please go to our web site: www.avagotech.com

Avago, Avago Technologies, and the A logo are trademarks of Avago Technologies in the United States and other countries. Data subject to change. Copyright © 2005-2008 Avago Technologies. All rights reserved. Obsoletes 5989-3746EN AV02-1283EN - July 23, 2008

Avago
TECHNOLOGIES