

OMP60 optical transmission probe

RENISHAW 
OMP60
MADE IN UK
SERIAL No. 0R0098



Flexible
probing solution



Reliable
modulated optical
transmission



Outstanding
performance for less scrap
and higher profits

OMP60 – innovative process control

Tackle process variation at source, and reap the rewards

The higher the degree of human involvement in the manufacturing process, the higher the risk for error. Automated in-process measurement using Renishaw probes can help **eliminate the risk**. The Renishaw OMP60 optical probe system can facilitate the following measures for enhanced management of your production leading to an **increase in your profits**.

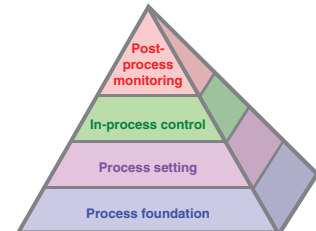

Process setting

Automated on-machine measurement of component position and alignment.

- Eliminate costly fixtures and manual setting errors
- Introduce new processes quickly and respond to new customer needs
- Set up faster, improve quality and reduce scrap

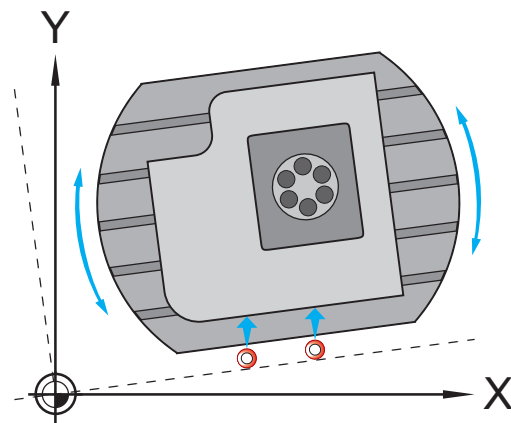

In-process control

Automated measurement of roughed and finished multi-axis features.

- Improve process capability and traceability
- Compensate for environmental and machine conditions
- Reduce non-productive time and scrap
- Increase productivity and profits

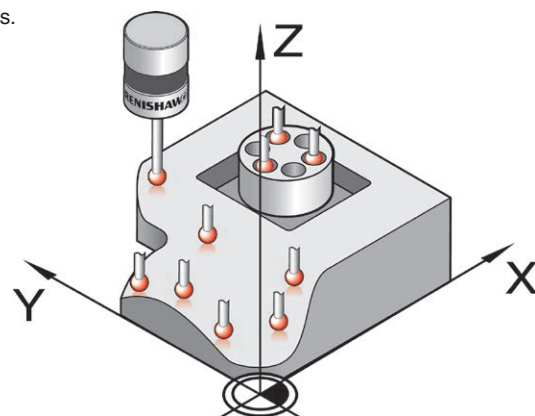

Probing pays...

Machine tools that are optimised to cut more metal, more reliably and more accurately will quickly **maximise productivity, profits and your competitive edge.**



Automated part setting with the Renishaw OMP60 probe is up to 10 times faster than manual methods, which means immediate and **significant cost savings.**

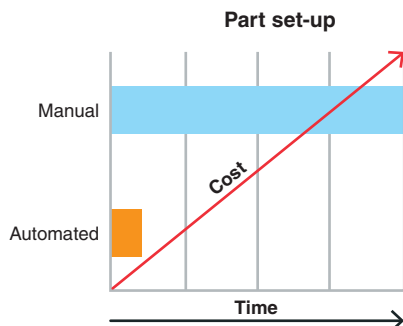

Scrap and rework reduce productivity and profits. The Renishaw OMP60 probe helps guarantee “right first time” parts which means **reduced waste and increased profits.**

OMP60 key features

- Compact design with optical transmission for medium machining centres and mill-turn centres
- Kinematic design — proven and patented
- Trigger logic™ for quick and easy set-up
- Secure modulated optical transmission offers increased resistance to light interference

... the Renishaw way

Renishaw, an established world leader in metrology solutions invented the touch-trigger probe in the 1970s.

Decades of customer focus and investment in development, coupled with our own manufacturing experience enables us to provide **innovative** and **exceptional products** that are unmatched for technical excellence and performance.

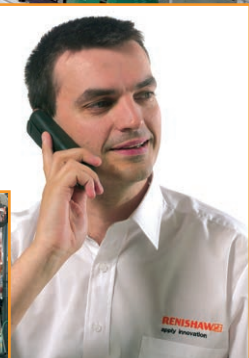

Customer comment

“We have now used probing systems on this cell for over 6 years and have cut costs and times, with a step change in process control and consistency.”

Andrew Cartledge, Dunlop Aerospace Braking Systems

OMP60 – compact, robust and proven technology

The world's first touch-trigger probe was based on a kinematic resistive principle. Today the basis of this proven design continues to play an invaluable role in part set-up, measurement and process control. This has firmly established Renishaw as a world leader in the design, manufacture and support of dimensional measurement products.

Renishaw is trusted and its products chosen by the world's leading machine builders and the majority of end-users.



The world's first touch-trigger probe

Principle of operation

Three equally spaced rods rest on six tungsten carbide balls to provide six points of contact.

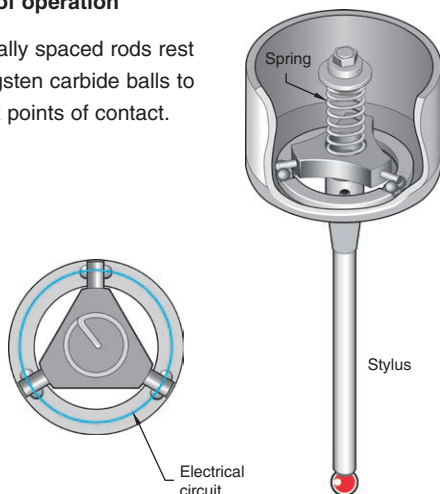

Under load of the spring, contact patches are created between the balls and the rods through which the electrical current flows. Upon making contact with (touching) a work-piece, the force translated through the stylus moves the balls and rods apart thus reducing the size of the contact patches and increasing their electrical resistance.

When a defined threshold is reached the probe is triggered.

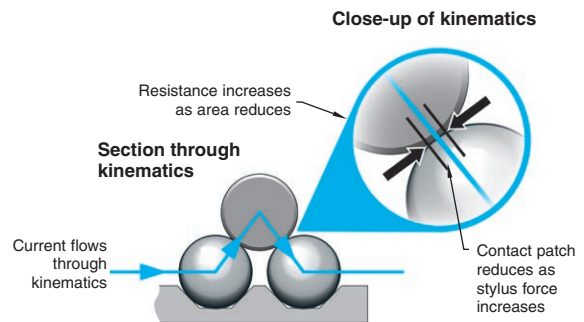

Repeatable electrical triggering and mechanical reseating of the mechanism are critical to this process and fundamental to reliable metrology.

A multitude of applications

Suitable for medium to large machining and mill-turn centres the OMP60 features an integrated probe module for exceptional robustness and generous over-travel. Its state-of-the-art modulated optical transmission combined with compact design enables users to:

- Benefit from a wide variety of probing applications with reliable optical transmission
- Access previously difficult to reach workpiece areas such as small recesses and awkward features
- Easily retrofit to existing machines

Advantages

- Proven Renishaw technology
- Robust in the harshest environment
- Reliable measurement
- Long service life
- Fast to install
- Easy to use

Key benefits

- Reduced set-up and calibration time
- More time for machining
- Improved process control and quality
- Reduced rework, concessions and scrap
- Increased automation and reduced operator intervention
- Increased payback and profits
- Greater competitive edge and business opportunity

OMP60 and modulated transmission optimised for safe, reliable and efficient performance.

The benefits of modulated transmission

Renishaw's modulated optical technology uses coded signals and is optimised to work within areas having other light sources.

In addition to providing secure optical transmission, the technology is integrated into the OMM-2 and OSI multi-probe interface allowing an OMP60 to be used in conjunction with up to two Renishaw optical tool setters (OTS) providing even greater flexibility and performance benefits. Other system configurations are available.



The advantages are clear to see

- Resistant to interference from other light sources
- Robust and proven transmission method
- Single interface supports multiple probes
- Can be used with automatic tool changers
- Suitable for retrofit installation



Example of multi-probe system

Ease of use and reliability

Unique to Renishaw, Trigger Logic™ is a simple method enabling the user to quickly adjust probe mode settings for specific applications.

Constructed from the highest grade materials, Renishaw probes are robust and reliable in the harshest environments including shock, vibration, temperature extremes and even continual liquid immersion.

Also available as OMP60M, a modular system combining adaptors, extensions and Renishaw's LP2 touch probe to solve difficult application and restricted space problems.



About Renishaw

Renishaw is an established world leader in engineering technologies, with a strong history of innovation in product development and manufacturing. Since its formation in 1973, the company has supplied leading-edge products that increase process productivity, improve product quality and deliver cost-effective automation solutions.

A worldwide network of subsidiary companies and distributors provides exceptional service and support for its customers.

Products include:

- Additive manufacturing, vacuum casting, and injection moulding technologies for design, prototyping, and production applications
- Advanced material technologies with a variety of applications in multiple fields
- Dental CAD/CAM scanning and milling systems and supply of dental structures
- Encoder systems for high accuracy linear, angle and rotary position feedback
- Fixturing for CMMs (co-ordinate measuring machines) and gauging systems
- Gauging systems for comparative measurement of machined parts
- High speed laser measurement and surveying systems for use in extreme environments
- Laser and ballbar systems for performance measurement and calibration of machines
- Medical devices for neurosurgical applications
- Probe systems and software for job set-up, tool setting and inspection on CNC machine tools
- Raman spectroscopy systems for non-destructive material analysis
- Sensor systems and software for measurement on CMMs
- Styli for CMM and machine tool probe applications

For worldwide contact details, please visit our main website at www.renishaw.com/contact

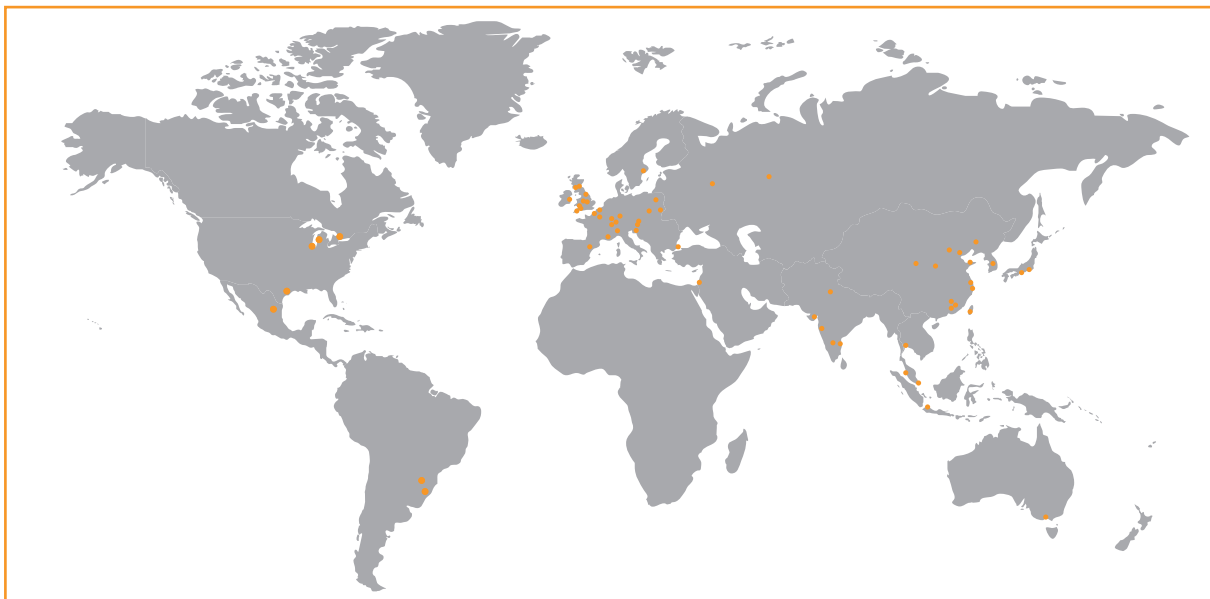

RENISHAW HAS MADE CONSIDERABLE EFFORTS TO ENSURE THE CONTENT OF THIS DOCUMENT IS CORRECT AT THE DATE OF PUBLICATION BUT MAKES NO WARRANTIES OR REPRESENTATIONS REGARDING THE CONTENT. RENISHAW EXCLUDES LIABILITY, HOWSOEVER ARISING, FOR ANY INACCURACIES IN THIS DOCUMENT.

©2013 Renishaw plc. All rights reserved.

Renishaw reserves the right to change specifications without notice

RENISHAW and the probe symbol used in the RENISHAW logo are registered trade marks of Renishaw plc in the United Kingdom and other countries. apply innovation and names and designations of other Renishaw products and technologies are trade marks of Renishaw plc or its subsidiaries. All other brand names and product names used in this document are trade names, trade marks or registered trade marks of their respective owners.



H - 2000 - 3373 - 02 - A

Issued: 0213 Part no. H-2000-3373-02-A