



goldsit
OFFICEFURNITURE

PRICE LIST



goldsit
Always**Reachable**





Welcome to the epitome of chair & sofa ergonomic excellence and contemporary design – where innovation meets comfort seamlessly. As the vanguard in the realm of office seating. Goldsit takes pride in crafting a narrative of workplace bliss through our exceptional creations. Our commitment goes beyond the conventional; we are not just manufacturers; we are architects of productivity and champions of well-being. Step into a world where every curve, stitch, and material is meticulously curated to redefine the way you experience your ergonomic chairs. Welcome to a realm where comfort isn't just a luxury but a necessity, and design isn't just aesthetics but a statement of sophistication. Welcome to Goldsit, where every office chair, every sofas every piece of furniture, tells a tale of innovation and unparalleled craftsmanship. Your journey to an elevated office experience begins here.

CHAIRS

TASK CHAIRS

MERCUR 000 PA	DESCRIPTION	DIMENSIONS	Price
	Silent Caster with Brake System Class 4 Gas Spring Weight-activated Synchro Mechanism Molded Foam Seat Sliding Seat System 3D Armrests Adjustable Lumbar Support Mesh Back Swivel Adjustable Headrest	Width: 26-27" Depth: 22-25" Height: 48" Seat Width: 20" Seat Depth: 17-19" Back Width: 18" Back Height: 30"	Cube ft ³ 4,52 Quantity per Package 1 Weight Rating 350 lbs \$450,00
55.3.1.51506.22			

MERCUR 100 PA	DESCRIPTION	DIMENSIONS	Price
	Silent Caster with Brake System Class 4 Gas Spring Weight-activated Synchro Mechanism Molded Foam Seat Sliding Seat System 3D Armrests Adjustable Lumbar Support Mesh Back Swivel	Width: 26-27" Depth: 22-25" Height: 40" Seat Width: 20" Seat Depth: 17-19" Back Width: 18" Back Height: 22"	Cube ft ³ 4,52 Quantity per Package 1 Weight Rating 350 lbs \$440,00
55.3.2.51606.22			

SATURN 000 PA	DESCRIPTION	DIMENSIONS	Price
	Silent Caster with Brake System Class 4 Gas Spring Weight-activated Synchro Mechanism Molded Foam Seat Sliding Seat System 3D Armrests Adjustable Lumbar Support Mesh Back Swivel Adjustable Headrest	Width: 26-27" Depth: 22-25" Height: 48" Seat Width: 20" Seat Depth: 17-19" Back Width: 19" Back Height: 30"	Cube ft ³ 4,52 Quantity per Package 1 Weight Rating 350 lbs \$455,00
55.3.1.61006.22			

CHAIRS

SATURN 100 PA	DESCRIPTION	DIMENSIONS		Price
	Silent Caster with Brake System Class 4 Gas Spring Weight-activated Synchro Mechanism Molded Foam Seat Sliding Seat System 3D Armrests Adjustable Lumbar Support Mesh Back Swivel	Width: 26-27" Depth: 22-25" Height: 40" Seat Width: 20" Seat Depth: 17-19" Back Width: 19" Back Height: 22"	Cube ft ³ 4,52 Quantity per Package 1 Weight Rating 350 lbs	\$445,00
55.3.2.61106.22				

QUATRO 000 PA	DESCRIPTION	DIMENSIONS		Price
	Silent Caster Class 4 Gas Spring Synchro-Tilt Molded Foam Seat 3D Armrests Fixed Lumbar Support Mesh Back Swivel Adjustable Headrest	Width: 26-27" Depth: 24" Height: 48" Seat Width: 20" Seat Depth: 17" Back Width: 19" Back Height: 30"	Cube ft ³ 4,52 Quantity per Package 1 Weight Rating 350 lbs	\$405,00
55.3.1.50002.22				

QUATRO 100 PA	DESCRIPTION	DIMENSIONS		Price
	Silent Caster Class 4 Gas Spring Synchro-Tilt Molded Foam Seat 3D Armrests Fixed Lumbar Support Mesh Back Swivel	Width: 26-27" Depth: 24" Height: 40" Seat Width: 20" Seat Depth: 17" Back Width: 19" Back Height: 22"	Cube ft ³ 4,52 Quantity per Package 1 Weight Rating 350 lbs	\$380,00
55.3.2.50102.22				

CHAIRS

SPACE 000 FP	DESCRIPTION	DIMENSIONS	Price
	Silent Caster Class 4 Gas Spring Synchro-Tilt Molded Foam Seat Fixed Armrests Mesh Back Swivel Wide Headrest	Width: 24" Depth: 25" Height: 50" Seat Width: 20" Seat Depth: 19" Back Width: 21" Back Height: 32"	Cube ft ³ 5,55 Quantity per Package 1 Weight Rating 350 lbs \$435,00
55.3.1.61500.22			

SPACE 100 FP	DESCRIPTION	DIMENSIONS	Price
	Silent Caster Class 4 Gas Spring Synchro-Tilt Molded Foam Seat Fixed Armrests Mesh Back Swivel	Width: 24" Depth: 25" Height: 43" Seat Width: 20" Seat Depth: 19" Back Width: 21" Back Height: 25"	Cube ft ³ 5,55 Quantity per Package 1 Weight Rating 350 lbs \$420,00
55.3.2.61600.22			

SPACE 000 DP	DESCRIPTION	DIMENSIONS	Price
	Silent Caster Class 4 Gas Spring Synchro-Tilt Molded Foam Seat Fixed Armrests Upholstered Seat and Backrest Swivel Wide Headrest	Width: 24" Depth: 25" Height: 50" Seat Width: 20" Seat Depth: 19" Back Width: 21" Back Height: 32"	Cube ft ³ 5,55 Quantity per Package 1 Weight Rating 350 lbs \$465,00
55.3.1.61501.22			

CHAIRS

SPACE 100 DP	DESCRIPTION	DIMENSIONS	Price
	Silent Caster Class 4 Gas Spring Synchro-Tilt Molded Foam Seat Fixed Armrests Upholstered Seat and Backrest Swivel	Width: 24" Depth: 25" Height: 43" Seat Width: 20" Seat Depth: 19" Back Width: 21" Back Height: 25"	Cube ft ³ 5,55 Quantity per Package 1 Weight Rating 350 lbs \$445,00

55.3.2.61601.22

CHAIRS

OFFICE CHAIRS

MIA 100 C	DESCRIPTION	DIMENSIONS		Price
	Silent Caster Class 4 Gas Spring Chrome Base Molded Foam Seat and Backrest Swivel Height Adjustable	Width: 25" Depth: 24" Height: 31" Seat Width: 18" Seat Depth: 18" Back Width: 17" Back Height: 14"	Cube ft ³ 8,53 Quantity per Package 1 Weight Rating 350 lbs	\$510,00
55.2.2.01701.03				

ALTO 100 C	DESCRIPTION	DIMENSIONS		Price
	Silent Caster Class 4 Gas Spring Chrome Base Molded Foam Seat and Backrest Swivel Height Adjustable	Width: 25" Depth: 24" Height: 29" Seat Width: 18" Seat Depth: 18" Back Width: 16" Back Height: 11"	Cube ft ³ 7,09 Quantity per Package 1 Weight Rating 350 lbs	\$465,00
55.2.2.01651.53				

CHAIRS

MULTIPURPOSE CHAIRS

M 300 P	DESCRIPTION	DIMENSIONS	Price
	U Form Base Molded Foam Seat Mesh Backrest	Width: 23" Depth: 23" Height: 35" Seat Width: 19" Seat Depth: 19" Back Width: 18" Back Height: 18"	Cube ft ³ 3,74 Quantity per Package 2 Weight Rating 350 lbs \$300,00
55.3.3.50302.21			

MEGA 010 P	DESCRIPTION	DIMENSIONS	Price
	Silent Caster Class 4 Gas Spring Molded Foam Seat Swivel Height Adjustable	Width: 20" Depth: 20" Height: 19"	Cube ft ³ 1,42 Quantity per Package 1 Weight Rating 350 lbs \$155,00
55.1.4.02012.02			

ZEPLIN 120 B	DESCRIPTION	DIMENSIONS	Price
	Painted Pipe Base Connection Point on the Legs Upholstered Seat	Width: 21" Depth: 23" Height: 33" Seat Width: 18" Seat Depth: 19" Back Width: 18" Back Height: 15"	Cube ft ³ 8,36 Quantity per Package 2 Weight Rating 350 lbs \$475,00
55.3.3.60122.01			

CHAIRS

ZEPLIN 130 B	DESCRIPTION	DIMENSIONS	Price	
	Painted Pipe High Base Connection Point on the Legs Upholstered Seat	Width: 21" Depth: 26" Height: 45" Seat Width: 18" Seat Depth: 19" Back Width: 18" Back Height: 15"	Cube ft ³ 17,90 Quantity per Package 1 Weight Rating 350 lbs	\$900,00
55.3.3.60132.03				

MARS 60 B	DESCRIPTION	DIMENSIONS	Price	
	Painted Pipe Base Connection Point on the Legs Upholstered Seat and Backrest	Width: 19" Depth: 23" Height: 33" Seat Width: 18" Seat Depth: 17" Back Width: 19" Back Height: 15"	Cube ft ³ 2,64 Quantity per Package 5 Weight Rating 350 lbs	\$180,00
55.1.5.01064.01				

MARS 61 B	DESCRIPTION	DIMENSIONS	Price	
	Painted Pipe Base Connection Point on the Legs Upholstered Seat	Width: 19" Depth: 23" Height: 33" Seat Width: 18" Seat Depth: 17" Back Width: 19" Back Height: 15"	Cube ft ³ 2,64 Quantity per Package 5 Weight Rating 350 lbs	\$170,00
55.1.5.01065.01				

CHAIRS

MARS CART	DESCRIPTION	DIMENSIONS	Price
	Casters with Brake System Metal profile base 15 Chairs capacity	Width: 40" Depth: 24" Height: 16"	Cube ft ³ 8,48 Quantity per Package 1 \$615,00
55.1.5.A1060.00			

EXECUTIVE CHAIRS

SALDA 000 C	DESCRIPTION	DIMENSIONS	Price
	Silent Caster Aluminium Base Class 4 Gas Spring Weight-activated Synchro Mechanism Molded Foam Seat Siliconized fiber foam backrest Swivel Height Adjustable	Width: 30" Depth: 28" Height: 51" Seat Width: 18" Seat Depth: 19" Back Width: 24" Back Height: 29"	Cube ft ³ 12,37 Quantity per Package 1 Weight Rating 350 lbs \$1.350,00
55.2.1.79501.53			

SILVER 000 C	DESCRIPTION	DIMENSIONS	Price
	Silent Caster Aluminium Base Class 4 Gas Spring Weight-activated Synchro Mechanism Molded Foam Seat 1" Feather foam backrest Swivel Height Adjustable	Width: 29" Depth: 27" Height: 49" Seat Width: 19" Seat Depth: 19" Back Width: 23" Back Height: 30"	Cube ft ³ 12,37 Quantity per Package 1 Weight Rating 350 lbs \$1.350,00
55.2.1.80001.53			

SOFAS

SOFAS

KNP 01



DIMENSIONS

Width: 31"
Depth: 26"
Height: 31"
Seat Width: 23"
Seat Depth: 21"

Price

Cube ft ³	10,11	\$680,00
Quantity per Package	1	
Weight Rating	300 lbs	

55.4.7.K9281.01.53

KNP 02



DIMENSIONS

Width: 26"
Depth: 26"
Height: 31"
Seat Width: 22"
Seat Depth: 21"

Price

Cube ft ³	9,08	\$580,00
Quantity per Package	1	
Weight Rating	300 lbs	

55.4.7.K9285.01.53

KNP 03



DIMENSIONS

Width: 26"
Depth: 26"
Height: 31"
Seat Width: 22"
Seat Depth: 21"

Price

Cube ft ³	9,08	\$580,00
Quantity per Package	1	
Weight Rating	300 lbs	

55.4.7.K9286.01.53

SOFAS

KNP 04	DIMENSIONS	Price
	Width: 22" Depth: 26" Height: 31" Seat Width: 22" Seat Depth: 21"	Cube ft ³ 7,24 Quantity per Package 1 Weight Rating 300 lbs
55.4.7.K9282.01.03		\$535,00

KNP 05	DIMENSIONS	Price
	Width: 22" Depth: 26" Height: 31" Seat Width: 22" Seat Depth: 26"	Cube ft ³ 3,03 Quantity per Package 1 Weight Rating 300 lbs
55.4.7.K9293.01.03		\$380,00

KNP 06	DIMENSIONS	Price
	Width: 53" Depth: 26" Height: 31" Seat Width: 44" Seat Depth: 21"	Cube ft ³ 17,11 Quantity per Package 1 Weight Rating 300 lbs
55.4.7.K9283.01.53		\$1.070,00

SOFAS

KNP 07	DIMENSIONS			Price
	Width: 48"	Cube ft ³	15,48	\$920,00
	Depth:26"	Quantity per Package	1	
	Height: 31"	Weight Rating	300 lbs	
	Seat Width: 44"			
	Seat Depth: 21"			
55.4.7.K9287.01.53				

KNP 08	DIMENSIONS			Price
	Width: 48"	Cube ft ³	15,48	\$920,00
	Depth:26"	Quantity per Package	1	
	Height: 31"	Weight Rating	300 lbs	
	Seat Width: 44"			
	Seat Depth: 21"			
55.4.7.K9288.01.53				

KNP 09	DIMENSIONS			Price
	Width: 43"	Cube ft ³	13,86	\$840,00
	Depth:26"	Quantity per Package	1	
	Height: 31"	Weight Rating	300 lbs	
	Seat Width: 43"			
	Seat Depth: 21"			
55.4.7.K9284.01.03				

SOFAS

KNP 10	DIMENSIONS			Price
	Width: 43"	Cube ft ³	5,40	\$545,00
	Depth: 26"	Quantity per Package	1	
	Height: 31"	Weight Rating	300 lbs	
	Seat Width: 43"			
	Seat Depth: 26"			
55.4.7.K9294.01.03				

KNP 11	DIMENSIONS			Price
	Width: 43"	Cube ft ³	13,86	\$950,00
	Depth: 24"	Quantity per Package	1	
	Height: 31"	Weight Rating	300 lbs	
	Seat Width: 43"			
	Seat Depth: 21"			
55.4.7.K9290.01.03				

KNP 12	DIMENSIONS			Price
	Width: 43"	Cube ft ³	13,86	\$980,00
	Depth: 24"	Quantity per Package	1	
	Height: 31"	Weight Rating	300 lbs	
	Seat Width: 43"			
	Seat Depth: 21"			
55.4.7.K9289.01.03				

SOFAS

KNP 13



DIMENSIONS

Width: 59"
Depth: 31"
Height: 31"
Seat Width: 59"
Seat Depth: 21"

Cube ft³
Quantity per Package
Weight Rating

22,33
1
300 lbs

Price

\$1.340,00

55.4.7.K9292.01.03

KNP 14



DIMENSIONS

Width: 59"
Depth: 31"
Height: 31"
Seat Width: 59"
Seat Depth: 21"

Cube ft³
Quantity per Package
Weight Rating

18,98
1
300 lbs

Price

\$1.250,00

55.4.7.K9291.01.03

SOFAS

KNPSP 01	DIMENSIONS		Price
	Width: 26" Depth: 26" Height: 11"	Cube ft ³ Quantity per Package Weight Rating	3,03 1 300 lbs \$260,00
55.4.7.K9295.03			

KNPSP 02	DIMENSIONS		Price
	Width: 44" Depth: 24" Height: 11"	Cube ft ³ Quantity per Package Weight Rating	4,97 1 300 lbs \$335,00
55.4.7.K9296.03			

KNPSP 03	DIMENSIONS		Price
	Width: 28" Depth: 24" Height: 11"	Cube ft ³ Quantity per Package Weight Rating	3,24 1 300 lbs \$270,00
55.4.7.K9297.03			

SOFAS

PARMA SINGLE



55.4.7.K9073.00

DIMENSIONS

Width: 26"
Depth: 27"
Height: 33"
Seat Width: 25"
Seat Depth: 20"

Cube ft³ 10,38
Quantity per Package 1
Weight Rating 300 lbs

Price

\$860,00

PARMA TWO SEAT



55.4.7.K9074.00

DIMENSIONS

Width: 50"
Depth: 27"
Height: 33"
Seat Width: 49"
Seat Depth: 20"

Cube ft³ 18,99
Quantity per Package 1
Weight Rating 300 lbs

Price

\$1.400,00

ENJOYSERIES



Welcome to the future of office design where versatility meets vibrancy in our modular and colorful furniture set! Redefining the traditional workplace aesthetic, this collection brings a refreshing burst of energy and creativity to your corporate environment.

Our modular furniture set offers colors and configurations, allowing you to design a workspace that reflects your company's dynamic spirit and fosters productivity and collaboration.

Ditch the monotony of uniformity and embrace the power of color to inspire innovation and spark creativity among your employees. Whether you prefer bold statement pieces or subtle accents, our diverse palette ensures there's something to suit every taste and corporate culture.

Elevate your office environment with our modular and colorful furniture set – where style, comfort, and functionality converge to create a workspace that's as vibrant and dynamic as your business.

ENJOY

Statement of Line

DESK



Enjoy US 01
Two Leg 60"/66"/72"

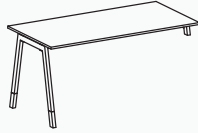

Enjoy US 02 Single Leg
60"/66"/72" Enjoy

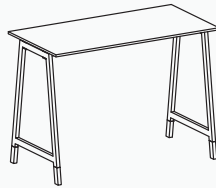

Enjoy US 03 High Leg
60"/66"/72"

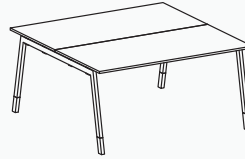

Enjoy US 04 Workstation
Two Leg 60"/66"/72"

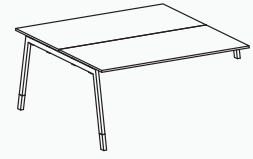

Enjoy US 05 Workstation
Single Leg 60"/66"/72"

UV Lacquer and melamine surfaced panels are used as table materials. Table thickness is 0.07". 4 edges are PVC banded. The legs are electrostatic powder painted and box profile. There is a polished wooden leg integrated into the leg profile. Height adjustable plastic pingo bases are used for the legs.

CREDENZA / SUPPORTS

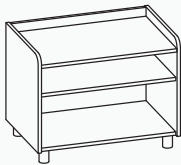

Enjoy
Low Credenza 30"-O

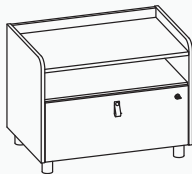

Enjoy
Low Credenza 30"-OF

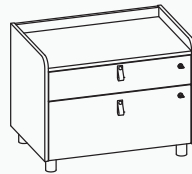

Enjoy
Low Credenza 30"-BF

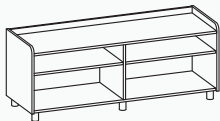

Enjoy
Low Credenza 60"-O

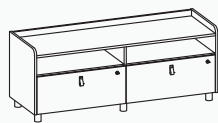

Enjoy
Low Credenza 60"-OF

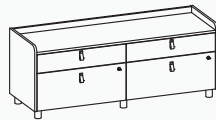

Enjoy
Low Credenza 60"-BF

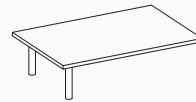

Enjoy Side Worksurface
With Support Leg 30"/36"/42"

UV Lacquer and melamine surface panels are used as panel materials. Material thickness is 0.07". All visible edges are PVC banded. The drawers are with telescopic rails with brake system. The side panels are curved. Polished wooden legs are used. Height adjustable plastic pingo bases are used for the legs. The handles are leather. All credenzas are with lock.

PEDESTAL

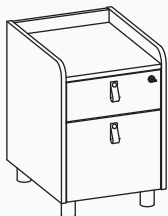

Enjoy Pedestal BF

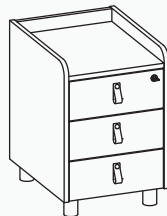

Enjoy Pedestal BBB

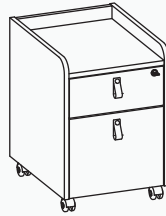

Enjoy Mobile
Pedestal With Caster BF

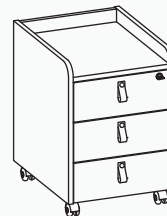

Enjoy Mobile
Pedestal With Caster BBB

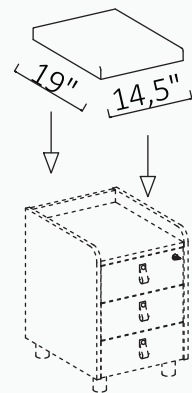

Enjoy Pedestal Cushion

UV Lacquer and melamine surface panels are used as panel materials. Material thickness is 0.07". All visible edges are PVC taped. The drawers are with telescopic rails with brake system. The side panels are curved. They have polished wooden legs with caster options. Wooden standing height adjustable plastic pingo bases are used for the legs. The handles are leather. All pedestals with central locked. The pedestal cushion is separate and preferable can be used for the upper part of the pedestals.

ENJOY

DRESS CABINET / STORAGE

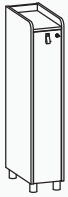

Enjoy
Dress Cabinet 10"

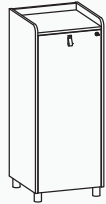

Enjoy
Dress Cabinet 20"



Enjoy
Two Drawer Lateral File

UV Lacquer and melamine surface panels used as panel materials. Material thickness is 0.07". All visible edges are PVC banded. The drawers are with telescopic rails with brake system. The side panels are curved. Polished wooden legs are used.
Wooden standing height adjustable plastic pingo bases are usable for the legs. The handles are leather. All cabinets and storages are with lock.

DESK DIVIDERS

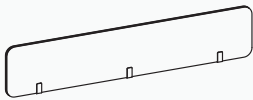

SP 01 Desk
Divider 60" / 66" / 72"

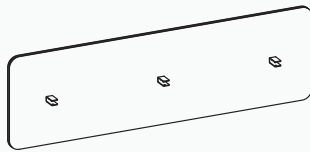

SP 02 Desk
Divider 60" / 66" / 72"

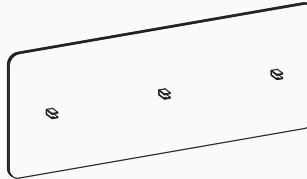

SP 03 Desk
Divider 60" / 66" / 72"

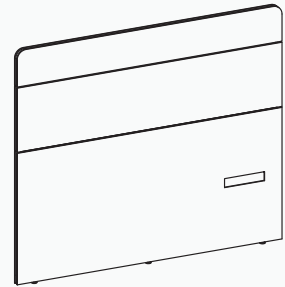

Fixed Divider Panel
60" / 66" / 72"

Desk divider panels are made of 1st Class raw MDF material and fabric upholstered.

Table fasteners are metal. SP 01 Desk dividers are usable with workstations.

SP 02 and SP 03 Desk divider panels can also be usable as modesty panels for Enjoy US 01, US 02 and US 03 desk models.

Fixed Divider Panels consist of metal and aluminium internal frame and fabric upholstered.

Upholstered panels have touch and close fastener and can be easily attached and removed.

"PLUG SET FOR FIXED DIVIDERS" can be installed on upholstered divider panels as an option.

They can be made functional by connecting "METAL ACCESSORIES" (RF 02, RF 04, RF 06) to the upper row channel on the panels.



ENJOY

METAL ACCESSORIES

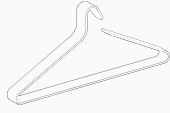

ASK 01 Hanger

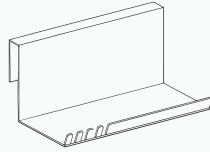

**RF 01 Metal Shelf
(for desk divider)**

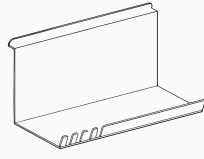

**RF 02 Metal Shelf
(for fixed divider panel)**

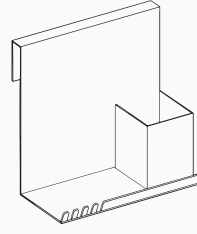

**RF 03 Metal Shelf
Pencil Case
(for desk divider)**

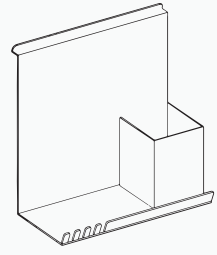

**RF 04 Metal Shelf
Pencil Case
(for fixed divider panel)**

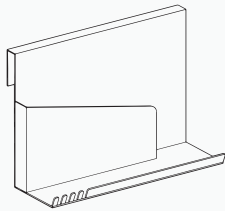

**RF 05 Metal Shelf
File Holder
(for desk divider)**

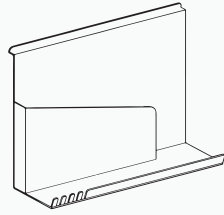

**RF 06
Metal Shelf File Holder
(for fixed divider panel)**

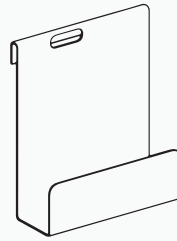

**RF 07
Metal Shelf Bag Holder**

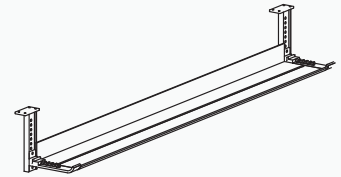

Aluminium Cable Tray



Plastic Cable Spine

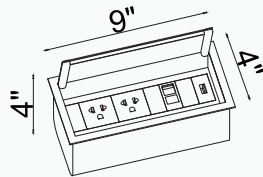

Plug Set for Desks

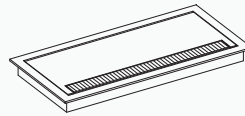

**Aluminium Plug Cover
for Desks**

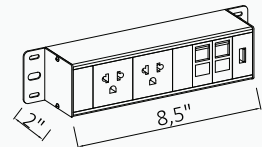

**Plug Set
for Fixed Divider**

ASK 01 : Metal material and electrostatic powder painted. Usable for Enjoy Dress Cabinets.

RF 01 – RF 03 – RF 05 Metal Accessories : Usable for SP 01 – 02 – 03 DESK DIVIDERS. All of them are metal materials and electrostatic powder painted.

RF 02 – RF 04 – RF 06 Metal Accessories : Usable for FIXED DIVIDERS by being attached to the channel.

All of them are metal material and electrostatic powder coated.

RF 07 Metal Accessory : This one can only be usable by attaching to the side panels of Enjoy Modules.

ALUMINUM CABLE TRAY : Electrostatic powder coated and mounted on the desk with height adjustable plastic connection apparatus on the side.

PLASTIC CABLE SPINE : Consists of interlocking spinal rings and has a mobile structure.

It has spaces through which cables can pass and it is fixed under the table with screws.

PLUG SET : Consists of an aluminium body and aluminium cover. It contains 2 Universal Sockets, 1 CAT6 data and 1 USB connector. Usable for Enjoy Desks.

ALUMINUM PLUG COVER : Consists of an aluminium cover. It is just a cover for cable passage. No hardware inside. Usable for Enjoy Desks.

PLUG SET FOR FIXED DIVIDERS : It has 2 Universal Sockets, 2 CAT6 data and 1 USB connector. Usable for Fixed Divider Panels.

ENJOY

DESK

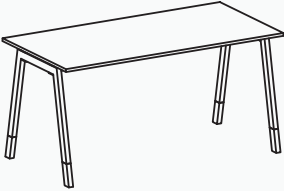
	DESCRIPTION	MODEL CODE	CUBE ft ³	Number of Packed	Price
	Enjoy US 01 Two Leg 60" / 66" / 72"				
	60"W x 30"D x 29,5 H	56.US801.01.060.01	5,60	1	\$810,00
	66"W x 30"D x 29,5 H	56.US801.01.066.01	6,11	1	\$845,00
	72"W x 30"D x 29,5 H	56.US801.01.072.01	6,62	1	\$890,00

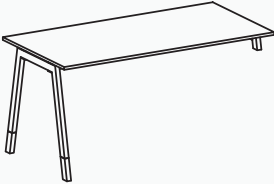
	DESCRIPTION	MODEL CODE	CUBE ft ³	Number of Packed	Price
	Enjoy US 02 Single Leg 60" / 66" / 72"				
	60"W x 30"D x 29,5 H	56.US802.01.060.01	5,60	1	\$765,00
	66"W x 30"D x 29,5 H	56.US802.01.066.01	6,11	1	\$795,00
	72"W x 30"D x 29,5 H	56.US802.01.072.01	6,62	1	\$840,00

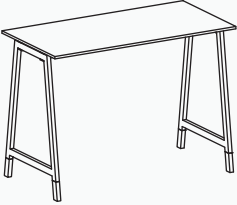

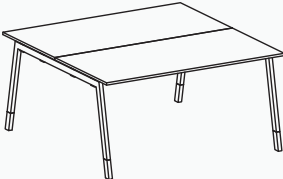

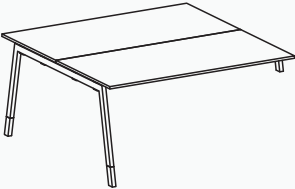
	DESCRIPTION	MODEL CODE	CUBE ft ³	Number of Packed	Price
	Enjoy US 03 High Leg 60" / 66" / 72"				
	60"W x 30"D x 43,5 H	56.US803.01.060.01	9,23	2	\$1.050,00
	66"W x 30"D x 43,5 H	56.US803.01.066.01	9,78	2	\$1.080,00
	72"W x 30"D x 43,5 H	56.US803.01.072.01	10,37	2	\$1.130,00

	DESCRIPTION	MODEL CODE	CUBE ft ³	Number of Packed	Price
	Enjoy US 04 Workstation Two Leg 60" / 66" / 72"				
	60"W x 60"D x 29,5 H	56.US804.01.060.01	10,78	2	\$1.440,00
	66"W x 60"D x 29,5 H	56.US804.01.066.01	11,33	2	\$1.490,00
	72"W x 60"D x 29,5 H	56.US804.01.072.01	12,01	2	\$1.560,00

	DESCRIPTION	MODEL CODE	CUBE ft ³	Number of Packed	Price
	Enjoy US 05 Workstation Single Leg 60" / 66" / 72"				
	60"W x 60"D x 29,5 H	56.US805.01.060.01	10,78	2	\$1.400,00
	66"W x 60"D x 29,5 H	56.US805.01.066.01	11,33	2	\$1.450,00
	72"W x 60"D x 29,5 H	56.US805.01.072.01	12,01	2	\$1.520,00

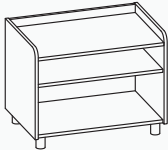
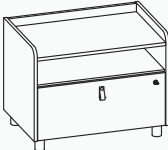
ENJOY

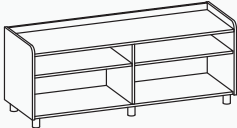
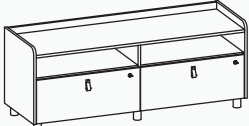
CREDANZA / SUPPORTS

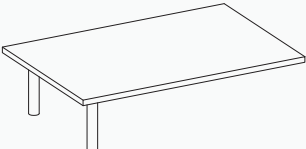
	<p>DESCRIPTION</p> <p>Enjoy Low Credenza 30" – O</p> <p>30"W x 20"D x 21,5"H</p>	<p>MODEL CODE</p> <p>56.US801.04.030.01</p>	<p>CUBE</p> <p>ft³</p> <p>9,13</p>	<p>Number of</p> <p>Packed</p> <p>1</p>	<p>Price</p> <p>\$725,00</p>
	<p>DESCRIPTION</p> <p>Enjoy Low Credenza 30" – OF</p> <p>30"W x 20"D x 21,5"H</p>	<p>MODEL CODE</p> <p>56.US801.04.030.02</p>	<p>CUBE</p> <p>ft³</p> <p>9,13</p>	<p>Number of</p> <p>Packed</p> <p>1</p>	<p>Price</p> <p>\$890,00</p>
	<p>DESCRIPTION</p> <p>Enjoy Low Credenza 30" – BF</p> <p>30"W x 20"D x 21,5"H</p>	<p>MODEL CODE</p> <p>56.US801.04.030.03</p>	<p>CUBE</p> <p>ft³</p> <p>9,13</p>	<p>Number of</p> <p>Packed</p> <p>1</p>	<p>Price</p> <p>\$990,00</p>
	<p>DESCRIPTION</p> <p>Enjoy Low Credenza 60" – O</p> <p>60"W x 20"D x 21,5"H</p>	<p>MODEL CODE</p> <p>56.US801.04.060.01</p>	<p>CUBE</p> <p>ft³</p> <p>17,69</p>	<p>Number of</p> <p>Packed</p> <p>1</p>	<p>Price</p> <p>\$1.250,00</p>
	<p>DESCRIPTION</p> <p>Enjoy Low Credenza 60" – OF</p> <p>60"W x 20"D x 21,5"H</p>	<p>MODEL CODE</p> <p>56.US801.04.060.02</p>	<p>CUBE</p> <p>ft³</p> <p>17,69</p>	<p>Number of</p> <p>Packed</p> <p>1</p>	<p>Price</p> <p>\$1.600,00</p>
	<p>DESCRIPTION</p> <p>Enjoy Low Credenza 60" – BF</p> <p>60"W x 20"D x 21,5"H</p>	<p>MODEL CODE</p> <p>56.US801.04.060.03</p>	<p>CUBE</p> <p>ft³</p> <p>17,69</p>	<p>Number of</p> <p>Packed</p> <p>1</p>	<p>Price</p> <p>\$1.890,00</p>
	<p>DESCRIPTION</p> <p>Enjoy Side Worksurface With Support Leg 30" / 36" / 42"</p> <p>30"W x 20"D x 8"H</p> <p>36"W x 20"D x 8"H</p> <p>42"W x 20"D x 8"H</p>	<p>MODEL CODE</p> <p>56.US801.98.030.01</p> <p>56.US801.98.036.01</p> <p>56.US801.98.042.01</p>	<p>CUBE</p> <p>ft³</p> <p>1,24</p> <p>1,48</p> <p>1,71</p>	<p>Number of</p> <p>Packed</p> <p>1</p> <p>1</p> <p>1</p>	<p>Price</p> <p>\$180,00</p> <p>\$200,00</p> <p>\$220,00</p>



ENJOY

PEDESTAL

	<p>DESCRIPTION</p> <p>Enjoy Pedestal BF 16"W x 20"D x 21,5"H</p>	<p>MODEL CODE</p> <p>56.US801.08.016.01</p>	<p>CUBE ft³</p> <p>5,24</p>	<p>Number of Packed</p> <p>1</p>	<p>Price</p> <p>\$735,00</p>
	<p>DESCRIPTION</p> <p>Enjoy Pedestal BBB 16"W x 20"D x 21,5"H</p>	<p>MODEL CODE</p> <p>56.US801.08.016.02</p>	<p>CUBE ft³</p> <p>5,24</p>	<p>Number of Packed</p> <p>1</p>	<p>Price</p> <p>\$780,00</p>
	<p>DESCRIPTION</p> <p>Enjoy Mobile Pedestal With Caster BF 16"W x 20"D x 21,5"H</p>	<p>MODEL CODE</p> <p>56.US801.08.016.03</p>	<p>CUBE ft³</p> <p>5,24</p>	<p>Number of Packed</p> <p>1</p>	<p>Price</p> <p>\$685,00</p>
	<p>DESCRIPTION</p> <p>Enjoy Mobile Pedestal With Caster BBB 16"W x 20"D x 21,5"H</p>	<p>MODEL CODE</p> <p>56.US801.08.016.04</p>	<p>CUBE ft³</p> <p>5,24</p>	<p>Number of Packed</p> <p>1</p>	<p>Price</p> <p>\$730,00</p>
	<p>DESCRIPTION</p> <p>Enjoy Pedestal Cushion 14,5W x 19"D x 2"H</p>	<p>MODEL CODE</p> <p>56.US801.01.038.01</p>	<p>CUBE ft³</p> <p>0,63</p>	<p>Number of Packed</p> <p>1</p>	<p>Price</p> <p>\$105,00</p>

ENJOY

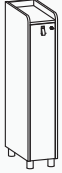
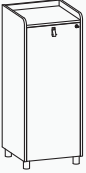
DRESS CABINET / STORAGE

	DESCRIPTION Enjoy Dress Cabinet 10" 10"W x 20"D x 50"H	MODEL CODE 56.US801.03.010.01	CUBE ft³ 7,28	Number of Packed 1	Price \$685,00
	DESCRIPTION Enjoy Dress Cabinet 20" 20"W x 20"D x 50"H	MODEL CODE 56.US801.03.020.01	CUBE ft³ 13,60	Number of Packed 1	Price \$1.035,00
	DESCRIPTION Enjoy Two Drawer Lateral File 36"W x 20"D x 29,5"H	MODEL CODE 56.US801.04.060.04	CUBE ft³ 14,54	Number of Packed 1	Price \$1.375,00

ENJOY

DESK DIVIDERS

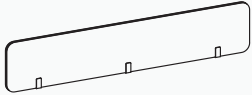
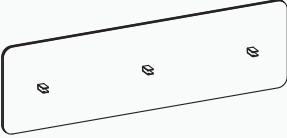
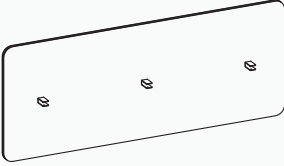
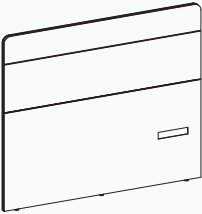

	DESCRIPTION	MODEL CODE	CUBE ft³	Number of Packed	Price
	SP 01 Desk Divider 60"/ 66"/ 72"				
	60"W x 12"H	56.US801.05.152.01	1,16	1	\$280,00
	66"W x 12"H	56.US801.05.168.01	1,28	1	\$300,00
	72"W x 12"H	56.US801.05.182.01	1,39	1	\$320,00
	DESCRIPTION	MODEL CODE	CUBE ft³	Number of Packed	Price
	SP 02 Desk Divider 60"/ 66"/ 72"				
	60"W x 18"H	56.US801.05.152.02	1,66	1	\$380,00
	66"W x 18"H	56.US801.05.168.02	1,83	1	\$400,00
	72"W x 18"H	56.US801.05.182.02	1,98	1	\$420,00
	DESCRIPTION	MODEL CODE	CUBE ft³	Number of Packed	Price
	SP 03 Desk Divider 60"/ 66"/ 72"				
	60"W x 24"H	56.US801.05.152.03	2,16	1	\$455,00
	66"W x 24"H	56.US801.05.168.03	2,38	1	\$475,00
	72"W x 24"H	56.US801.05.182.03	2,58	1	\$520,00
	DESCRIPTION	MODEL CODE	CUBE ft³	Number of Packed	Price
	Fixed Divider Panel 60"/ 66"/ 72"				
	60"W x 52"H	56.US801.05.060.01	5,99	1	\$1.065,00
	66"W x 52"H	56.US801.05.66.01	6,60	1	\$1.155,00
	72"W x 52"H	56.US801.05.72.01	7,13	1	\$1.250,00

ENJOY

METAL ACCESSORIES / ELECTRICAL SET

	DESCRIPTION ASK 01 Hanger 14"W x 1"D x 6"H	MODEL CODE 56.US801.08.037.01	CUBE ft³ 0,09	Number of Packed 1	Price \$70,00
	DESCRIPTION RF 01 Metal Shelf (for Desk Divider) 8,5"W x 5"D x 4"H	MODEL CODE 56.US801.07.022.03	CUBE ft³ 0,10	Number of Packed 1	Price \$65,00
	DESCRIPTION RF 02 Metal Shelf (for fixed Divider panel) 8,5"W x 5"D x 4"H	MODEL CODE 56.US801.07.022.04	CUBE ft³ 0,10	Number of Packed 1	Price \$65,00
	DESCRIPTION RF 03 Metal Shelf Pencil Case (for Desk Divider) 8,5"W x 5"D x 8,5"H	MODEL CODE 56.US801.07.022.01	CUBE ft³ 0,22	Number of Packed 1	Price \$105,00
	DESCRIPTION RF 04 Metal Shelf Pencil Case (for fixed Divider panel) 8,5"W x 5"D x 8,5"H	MODEL CODE 56.US801.07.022.05	CUBE ft³ 0,22	Number of Packed 1	Price \$105,00
	DESCRIPTION RF 05 Metal Shelf File Holder (for Desk Divider) 12,5"W x 5"D x 8,5"H	MODEL CODE 56.US801.07.022.02	CUBE ft³ 0,32	Number of Packed 1	Price \$120,00
	DESCRIPTION RF 06 Metal Shelf File Holder (for fixed Divider panel) 12,5"W x 5"D x 8,5"H	MODEL CODE 56.US801.07.022.06	CUBE ft³ 0,32	Number of Packed 1	Price \$120,00
	DESCRIPTION RF 07 Metal Shelf Bag Holder 14"W x 5,5"D x 16"H	MODEL CODE 56.US801.07.035.01	CUBE ft³ 0,51	Number of Packed 1	Price \$160,00

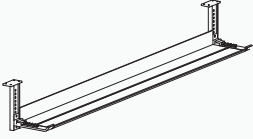
ENJOY

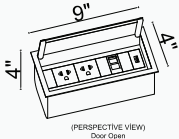
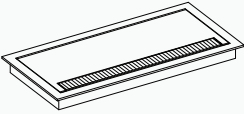
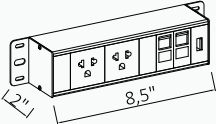
	<p>DESCRIPTION</p> <p>Aluminium Cable Tray</p> <p>42"W x 6"D x 5,5"H</p>	<p>MODEL CODE</p> <p>56.US825.17.000.02</p>	<p>CUBE ft³</p> <p>0,67</p>	<p>Number of Packed</p> <p>1</p>	<p>Price</p> <p>\$160,00</p>
	<p>DESCRIPTION</p> <p>Plastic Cable Spine</p> <p>4"ØW x 29,5"H</p>	<p>MODEL CODE</p> <p>56.US825.17.000.01</p>	<p>CUBE ft³</p> <p>0,32</p>	<p>Number of Packed</p> <p>1</p>	<p>Price</p> <p>\$65,00</p>
 <p>(PERSPECTIVE VIEW) Door Open</p>	<p>DESCRIPTION</p> <p>Plug Set for desk</p> <p>9"W x 4"D x 4"H</p>	<p>MODEL CODE</p> <p>56.US825.17.000.03</p>	<p>CUBE ft³</p> <p>0,24</p>	<p>Number of Packed</p> <p>1</p>	<p>Price</p> <p>\$310,00</p>
	<p>DESCRIPTION</p> <p>Aluminium Plug Cover for Desks</p> <p>9"W x 4"D x 2"H</p>	<p>MODEL CODE</p> <p>56.US825.17.000.04</p>	<p>CUBE ft³</p> <p>0,24</p>	<p>Number of Packed</p> <p>1</p>	<p>Price</p> <p>\$130,00</p>
	<p>DESCRIPTION</p> <p>Plug Set for Fixed Divider</p> <p>8,5"W x 2"D x 2"H</p>	<p>MODEL CODE</p> <p>56.US825.17.000.05</p>	<p>CUBE ft³</p> <p>0,11</p>	<p>Number of Packed</p> <p>1</p>	<p>Price</p> <p>\$230,00</p>

ENJOY

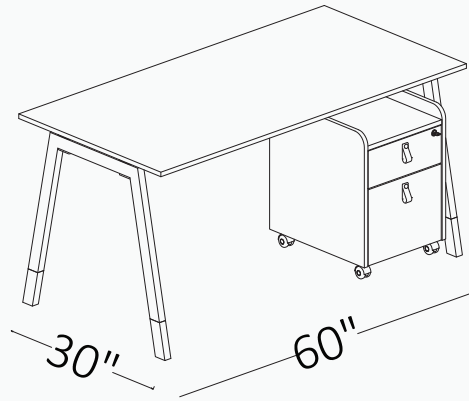

SET 1

QTY	DESCRIPTION	MODEL CODE	LIST PRICE	PRICE EXTENSION
1	Enjoy US 01 Two Leg 60"	56.US801.01.060.01	\$810,00	\$810,00
1	Enjoy Mobile Pedestal With Caster BF	56.US801.08.016.03	\$685,00	\$685,00
TOTAL				\$1.495,00

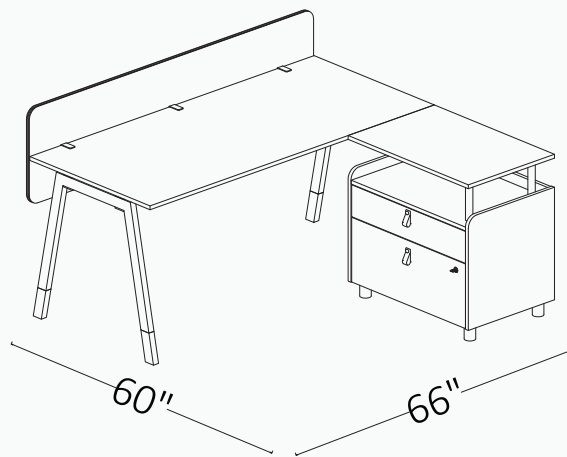

SET 2

QTY	DESCRIPTION	MODEL CODE	LIST PRICE	PRICE EXTENSION
1	Enjoy US 01 Two Leg 66"	56.US801.01.066.01	\$845,00	\$845,00
1	SP 02 Desk Divider 66"	56.US801.05.168.02	\$400,00	\$400,00
1	Enjoy Side Worksurface With Support Leg 30"	56.US801.98.030.01	\$180,00	\$180,00
1	Enjoy Low Credenza 30"-BF	56.US801.04.030.03	\$990,00	\$990,00
TOTAL				\$2.415,00

ENJOY

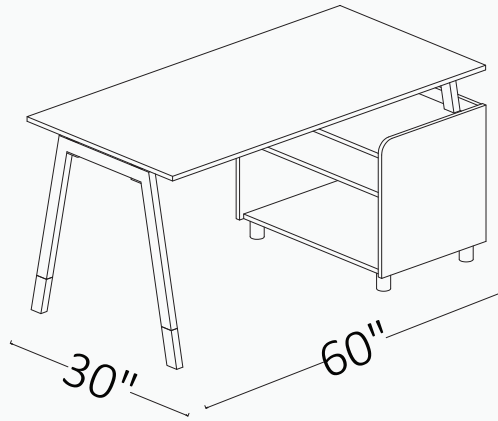

SET 3

QTY	DESCRIPTION	MODEL CODE	LIST PRICE	PRICE EXTENSION
1	Enjoy US 02 Single Leg 60"	56.US802.01.060.01	\$765,00	\$765,00
1	Enjoy Low Credenza 30" – O	56.US801.04.030.01	\$725,00	\$725,00
TOTAL				\$1.490,00

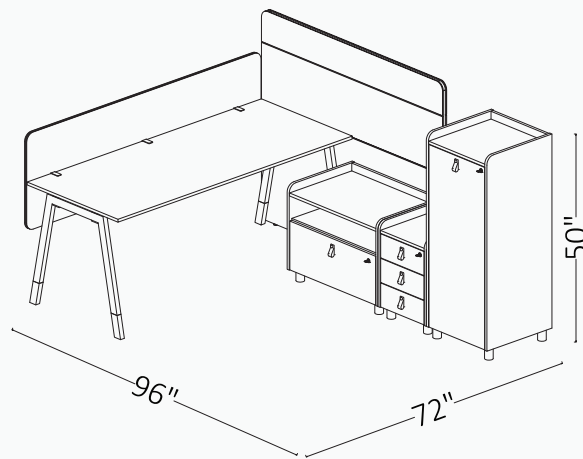

SET 4

QTY	DESCRIPTION	MODEL CODE	LIST PRICE	PRICE EXTENSION
1	Enjoy US 01 Two Leg 72"	56.US801.01.072.01	\$890,00	\$890,00
1	SP 03 Desk Divider 72"	56.US801.05.182.03	\$520,00	\$520,00
1	Enjoy Low Credenza 30" – OF	56.US801.04.030.02	\$890,00	\$890,00
1	Enjoy Pedestal BBB	56.US801.08.016.02	\$780,00	\$780,00
1	Enjoy Dress Cabinet 20"	56.US801.03.020.01	\$1.035,00	\$1.035,00
1	Fixed Divider Panel 60"	56.US801.05.060.01	\$1.065,00	\$1.065,00
TOTAL				\$5.180,00

ENJOY

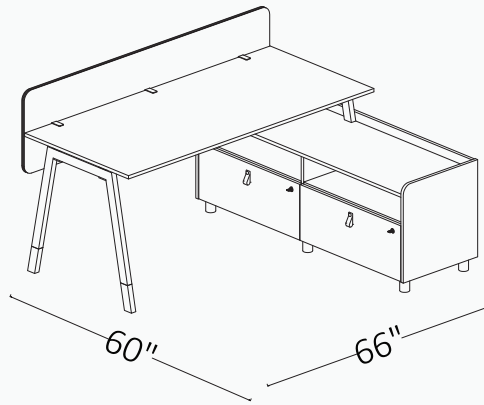

SET 5

QTY	DESCRIPTION	MODEL CODE	LIST PRICE	PRICE EXTENSION
1	Enjoy US 02 Single Leg 66"	56.US802.01.066.01	\$795,00	\$795,00
1	SP 02 Desk Divider 66"	56.US801.05.168.02	\$400,00	\$400,00
1	Enjoy Low Credenza 60"—OF	56.US801.04.060.02	\$1.600,00	\$1.600,00
TOTAL				\$2.795,00

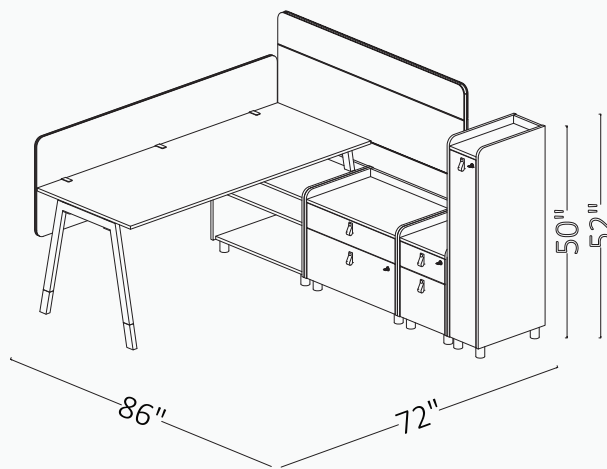

SET 6

QTY	DESCRIPTION	MODEL CODE	LIST PRICE	PRICE EXTENSION
1	Enjoy US 02 Single Leg 72"	56.US802.01.072.01	\$840,00	\$840,00
1	SP 03 Desk Divider 72"	56.US801.05.182.03	\$520,00	\$520,00
1	Enjoy Low Credenza 30"—O	56.US801.04.030.01	\$725,00	\$725,00
1	Enjoy Low Credenza 30"—BF	56.US801.04.030.03	\$990,00	\$990,00
1	Enjoy Pedestal BF	56.US801.08.016.01	\$735,00	\$735,00
1	Enjoy Dress Cabinet 10"	56.US801.03.010.01	\$685,00	\$685,00
1	Fixed Divider Panel 60"	56.US801.05.060.01	\$1.065,00	\$1.065,00
TOTAL				\$5.560,00

ENJOY

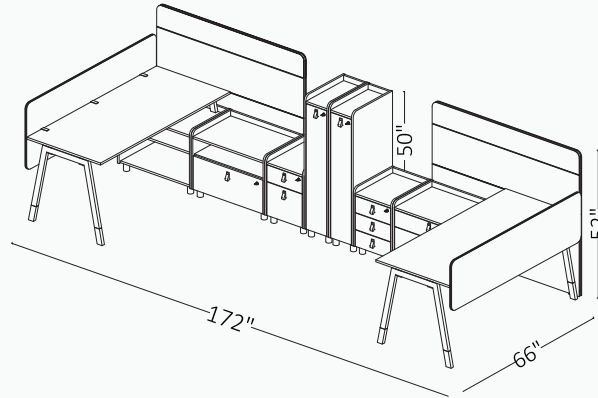

SET 7

QTY	DESCRIPTION	MODEL CODE	LIST PRICE	PRICE EXTENSION
1	Enjoy US 02 Single Leg 66"	56.US802.01.066.01	\$795,00	\$795,00
1	Enjoy US 01 Two Leg 66"	56.US801.01.066.01	\$845,00	\$845,00
1	Enjoy Low Credenza 30" – O	56.US801.04.030.01	\$725,00	\$725,00
1	Enjoy Low Credenza 30" – OF	56.US801.04.030.02	\$890,00	\$890,00
1	Enjoy Low Credenza 30" – BF	56.US801.04.030.03	\$990,00	\$990,00
1	Enjoy Pedestal BBB	56.US801.08.016.02	\$780,00	\$780,00
1	Enjoy Pedestal BF	56.US801.08.016.01	\$735,00	\$735,00
2	Enjoy Dress Cabinet 10"	56.US801.03.010.01	\$685,00	\$1,370,00
2	Fixed Divider Panel 60"	56.US801.05.060.01	\$1,065,00	\$2,130,00
1	SP 02 Desk Divider 66"	56.US801.05.168.02	\$400,00	\$400,00
1	SP 03 Desk Divider 66"	56.US801.05.168.03	\$475,00	\$475,00

TOTAL \$10,135,00

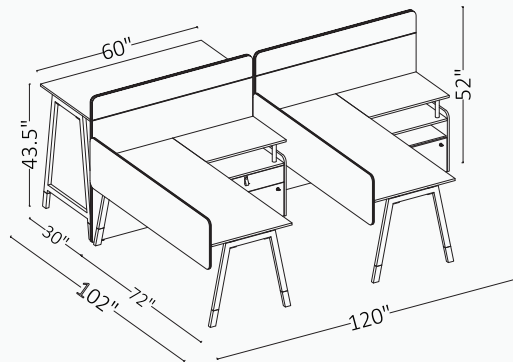

SET 8

QTY	DESCRIPTION	MODEL CODE	LIST PRICE	PRICE EXTENSION
2	Enjoy Us 01 Two Leg 72"	56.US801.01.072.01	\$890,00	\$1,780,00
2	SP 02 Desk Divider 72"	56.US801.05.182.02	\$420,00	\$840,00
1	Enjoy Low Credenza 30" – OF	56.US801.04.030.02	\$890,00	\$890,00
1	Enjoy Low Credenza 30" – BF	56.US801.04.030.03	\$990,00	\$990,00
2	Enjoy Side WorkSurface With Support Leg 30"	56.US801.98.030.01	\$180,00	\$360,00
2	Fixed Divider Panel 60"	56.US801.05.060.01	\$1,065,00	\$2,130,00
1	Enjoy Us 03 High Leg 60"	56.US803.01.060.01	\$1,050,00	\$1,050,00

TOTAL \$8,040,00

ENJOY

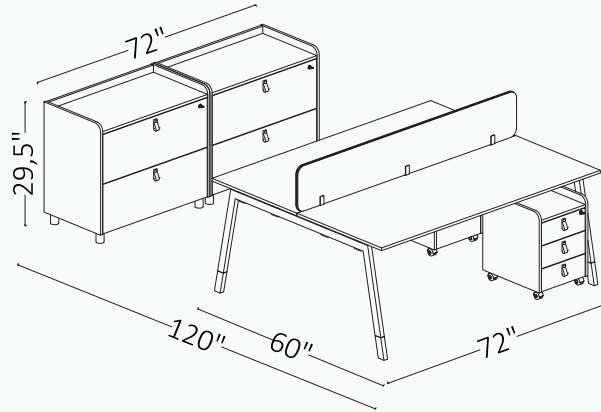

SET 9

QTY	DESCRIPTION	MODEL CODE	LIST PRICE	PRICE EXTENSION
1	Enjoy US 04 Workstation Two Leg 72"	56.US804.01.072.01	\$1560,00	\$1560,00
1	SP 01 Desk Divider 72"	56.US801.05.182.01	\$320,00	\$320,00
2	Enjoy Mobile Pedestal With Caster BBF	56.US801.08.016.04	\$730,00	\$1.460,00
2	Enjoy Two Drawer Lateral File	56.US801.04.060.04	\$1.370,00	\$2.750,00
			TOTAL	\$6.090,00

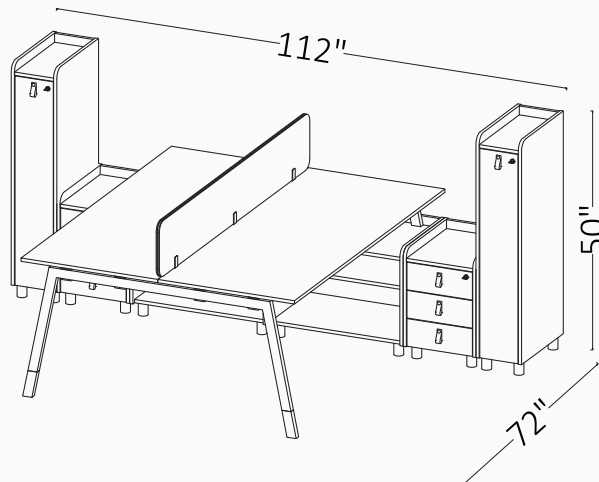

SET 10

QTY	DESCRIPTION	MODEL CODE	LIST PRICE	PRICE EXTENSION
1	Enjoy Us 05 Workstation Single Leg 72"	56.US805.01.072.01	\$1520,00	\$1.520,00
1	SP 01 Desk Divider 72"	56.US801.05.182.01	\$320,00	\$320,00
2	Enjoy Low Credenza 30"-O	56.US801.04.030.01	\$725,00	\$1.450,00
2	Enjoy Mobile Pedestal BBB	56.US801.08.016.02	\$780,00	\$1.560,00
2	Enjoy Dress Cabinet 10"	56.US801.03.010.01	\$685,00	\$1.370,00
			TOTAL	\$6.220,00

MOTTO SERIES



Welcome to the future of office design where versatility meets vibrancy in our modular and colorful furniture set! Redefining the traditional workplace aesthetic, this collection brings a refreshing burst of energy and creativity to your corporate environment.

Our modular furniture set offers colors and configurations, allowing you to design a workspace that reflects your company's dynamic spirit and fosters productivity and collaboration.

Ditch the monotony of uniformity and embrace the power of color to inspire innovation and spark creativity among your employees. Whether you prefer bold statement pieces or subtle accents, our diverse palette ensures there's something to suit every taste and corporate culture.

Elevate your office environment with our modular and colorful furniture set – where style, comfort, and functionality converge to create a workspace that's as vibrant and dynamic as your business.

MOTTO

Statement of Line

DESK



Motto US 01 Two Leg
60" / 66" / 72"

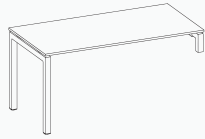

Motto US 02 Single Leg
60" / 66" / 72"

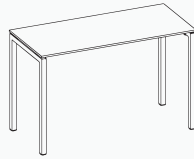

Motto US 03 High Leg
60" / 66" / 72"

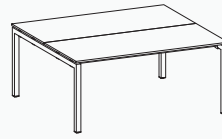

**Motto US 04 Workstation
Two Leg** 60" / 66" / 72"

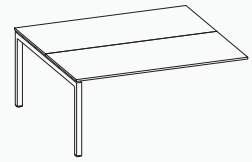

**Motto US 05 Workstation
Single Leg** 60" / 66" / 72"

Melamine surfaced panel is used as table material. Table material thickness is 0.07". 4 edges are PVC banded. The legs are electrostatic powder painted and box profile. Height adjustable plastic pingo bases are used for the legs. Modesty Panels are mounted on the table with metal connection brackets. Modesty Panel For L-Station: Can be used only for US 02 and US 05 Single Leg desk models.

MODESTY PANEL

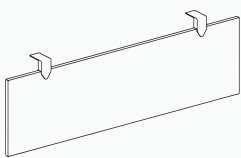

Motto Modesty Panel
60" / 66" / 72"

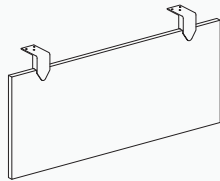

**Motto Modesty Panel
For L-Station**

CREDENZA

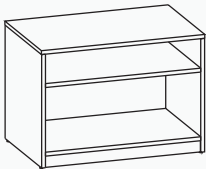

**Motto Low
Credenza 30" - O**

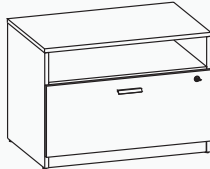

**Motto Low
Credenza 30" - OF**

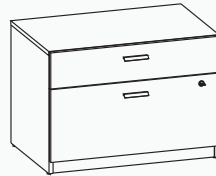

**Motto Low
Credenza 30" - BF**

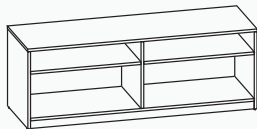

**Motto Low
Credenza 60" - O**

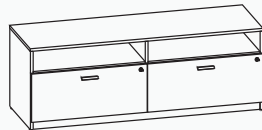

**Motto Low
Credenza 60" - OF**



**Motto Low
Credenza 60" - BF**

UV Lacquer and melamine surface panels are used as panel materials. Material thickness is 0.07". All visible edges are PVC taped. The drawers are with telescopic rails with brake system. The side panels are curved. Polished wooden legs are used. Height adjustable plastic pingo bases are used for the legs. Chrome-plated metal handles are used. All credenzas are with lock.

MOTTO

OVERHEAD

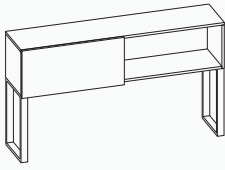

Motto O Leg Supported Overhead Cabinet With One Sliding Door

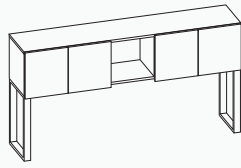

Motto O Leg Supported Overhead Cabinet With Four Door 66" / 72"

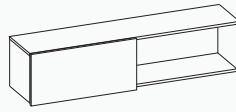

Motto Overhead Cabinet With One Sliding Door

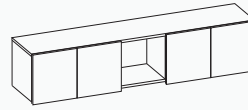

Motto Overhead Cabinet With Four Door 66" / 72"

Melamine surfaced panels are used as panel material. Material thickness is 0.07". All visible edges are PVC taped. Electrostatic powder coated box profile legs and crossbars are used in upper cabinets with metal legs. Other legless upper cabinets are mounted on the wall with hanging brackets. Slow closing hinges are used on cabinet doors. A sliding mechanism that can slide easily is used in the sliding door cabinet.

PEDESTAL / SUPPORTS



Motto Pedestal BF

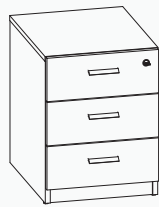

Motto Pedestal BBB

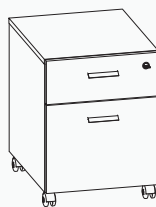

Motto Mobile Pedestal With Casters BF

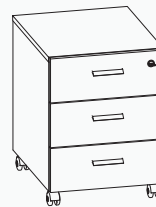

Motto Mobile Pedestal With Casters BBB

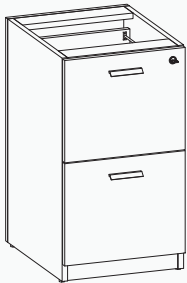

Motto Support Pedestal FF

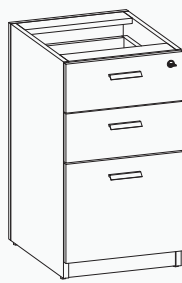

Motto Support Pedestal BBF

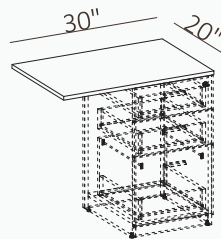

Motto Side Worksurface For Pedestal 30" / 36" / 42"

Melamine surfaced panels are used as panel material. Material thickness is 0.07". All visible edges are PVC taped. The drawers are with telescopic rails with brake system. Chrome plated metal handles are used on all pedestals.

All pedestals are produced with two options:

- Height adjustable plastic pingo based
- With casters

Support Pedestals are only available with height adjustable plastic bingo base. Side worksurfaces should be used with Support Pedestals. All models have central lock system.

MOTTO

DRESS CABINET / STORAGE

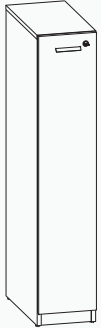

Motto
Low Dress Cabinet 10"

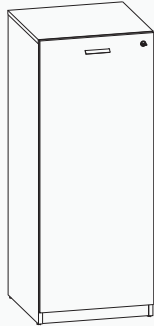

Motto
Low Dress Cabinet 20"

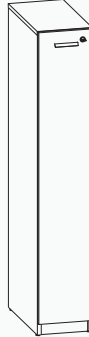

Motto
High Dress Cabinet 10"

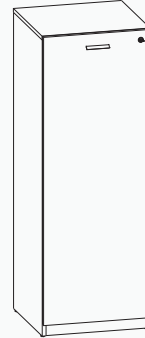

Motto
High Dress Cabinet 20"



Motto Storage Left Hand
Drawers Right Hand Door

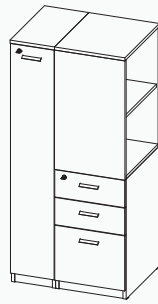

Motto Storage Right Hand
Drawers Left Hand Door

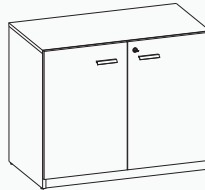

Motto
Two Door Storage Cabinet

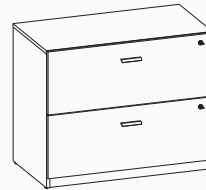

Motto
Two Drawer Lateral File

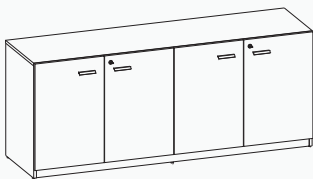

Motto
Four Door Storage Cabinet

Melamine surfaced panels are used as panel material. Material thickness is 0.07". All visible edges are PVC taped. Drawers and Lateral Files have telescopic rails with brake and central lock system. Chromium coated metal handles are used for all modules. Height adjustable plastic pingo bases are used for the legs. Retarding hinges are used for all the modules with doors. There are chrome plated hangers inside the Dress Cabinets. Storage modules with two covers and four covers have a portable and removable shelf inside. The doors of all modules are with lock system.

MOTTO

DESK DIVIDER

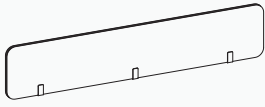

**SP 01 Desk
Divider 60"/66"/72"**

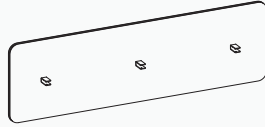

**SP 02 Desk
Divider 60"/66"/72"**

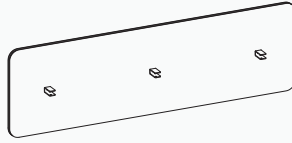

**SP 03 Desk
Divider 60"/66"/72"**

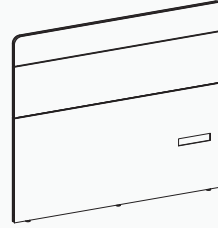

**Fixed Divider Panel
60" / 66" / 72"**

METAL ACCESSORIES / ELECTRICAL SET

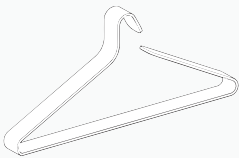

ASK 01 Hanger

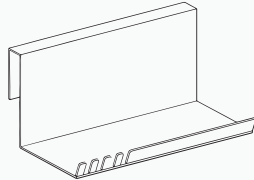

**RF 01 Metal Shelf
(for desk divider)**

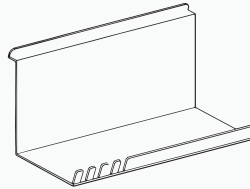

**RF 02 Metal Shelf
(for fixed divider panel)**

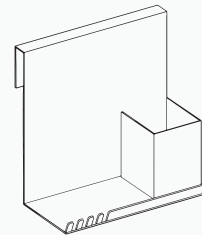

**RF 03 Metal Shelf
Pencil Case (for desk divider)**

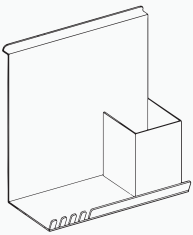

**RF 04 Metal Shelf
Pencil Case
(for fixed divider panel)**

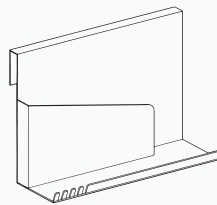

**RF 05 Metal Shelf
File Holder
(for desk divider)**

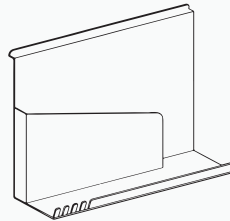

**RF 06 Metal Shelf
File Holder
(for fixed divider panel)**

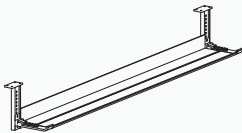

Aluminium Cable Tray

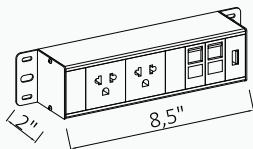

**Plug Set
for Fixed Divider**

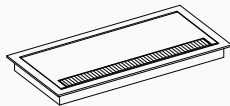

**Aluminium Plug Cover
for Desks**

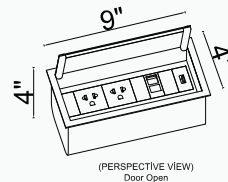

Plug Set for desk



Plastic Cable Spine

ASK 01 Hanger : Metal material and electrostatic powder painted. Usable for Motto Dress Cabinets.

RF 01 – RF 03 – RF 05 Metal Accessories : Usable for SP 01 – 02 – 03 DESK DIVIDERS. All of them are metal materials and electrostatic powder painted.

RF 02 – RF 04 – RF 06 Metal Accessories : Usable for FIXED DIVIDERS by being attached to the channel. All of them are metal material and electrostatic powder coated.

ALUMINIUM CABLE TRAY : Electrostatic powder coated and mounted on the desk with height adjustable plastic connection apparatus on the side.

PLASTIC CABLE SPINE : Consists of interlocking spinal rings and has a mobile structure. It has spaces through which cables can pass and it's fixed under the table with screws.

PLUG SET : Consists of an aluminium body and aluminium cover. It contains 2 Universal Sockets, 1 CAT6 data and 1 USB connector. Usable for Motto Desks.

ALUMINIUM PLUG COVER : Consists of an aluminium cover. It is just a cover for cable passage. No hardware inside. Usable for Motto Desks.

PLUG SET FOR FIXED DIVIDERS : It has 2 Universal Sockets, 2 CAT6 data and 1 USB connector. Usable for Fixed Divider Panels.

MOTTO

DESK

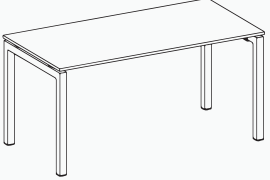
	DESCRIPTION	MODEL CODE	CUBE ft ³	Number of Packed	Price
	Motto Us 01 Two Leg 60" / 66" / 72"				
	60"W x 30"D x 29,5"H	56.US001.01.060.01	5,60	1	\$790,00
	66"W x 30"D x 29,5"H	56.US001.01.066.01	6,11	1	\$830,00
	72"W x 30"D x 29,5"H	56.US001.01.072.01	6,62	1	\$875,00

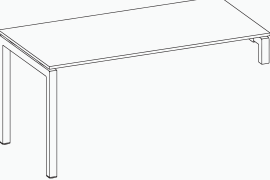
	DESCRIPTION	MODEL CODE	CUBE ft ³	Number of Packed	Price
	Motto US 02 Single Leg 60" / 66" / 72"				
	60"W x 30"D x 29,5"H	56.US002.01.060.01	5,60	1	\$750,00
	66"W x 30"D x 29,5"H	56.US002.01.066.01	6,11	1	\$800,00
	72"W x 30"D x 29,5"H	56.US002.01.072.01	6,62	1	\$840,00

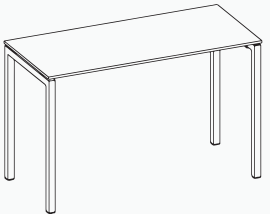
	DESCRIPTION	MODEL CODE	CUBE ft ³	Number of Packed	Price
	Motto US 03 High Leg 60" / 66" / 72"				
	60"W x 30"D x 43,5"H	56.US003.01.060.01	9,23	2	\$1.010,00
	66"W x 30"D x 43,5"H	56.US003.01.066.01	9,78	2	\$1.055,00
	72"W x 30"D x 43,5"H	56.US003.01.072.01	10,37	2	\$1.100,00

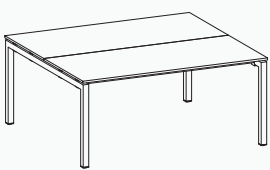
	DESCRIPTION	MODEL CODE	CUBE ft ³	Number of Packed	Price
	Motto US 04 Workstation Two Leg 60" / 66" / 72"				
	60"W x 60"D x 29,5"H	56.US004.01.060.01	10,78	2	\$1.400,00
	66"W x 60"D x 29,5"H	56.US004.01.066.01	11,33	2	\$1.460,00
	72"W x 60"D x 29,5"H	56.US004.01.072.01	12,01	2	\$1.520,00

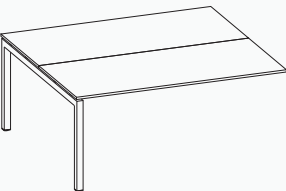
	DESCRIPTION	MODEL CODE	CUBE ft ³	Number of Packed	Price
	Motto US 05 Workstation Single Leg 60" / 66" / 72"				
	60"W x 60"D x 29,5"H	56.US005.01.060.01	10,78	2	\$1.380,00
	66"W x 60"D x 29,5"H	56.US005.01.066.01	11,33	2	\$1.440,00
	72"W x 60"D x 29,5"H	56.US005.01.072.01	12,01	2	\$1.500,00

MOTTO

MODESTY PANEL

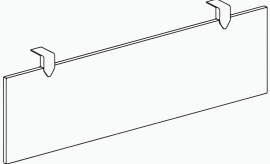
	DESCRIPTION	MODEL CODE	CUBE ft ³	Number of Packed	Price
	Motto Modesty Panel 60" / 66" / 72"				
	60"W x 14"D x 0,7"H	56.US001.01.060.02	1,08	1	\$240,00
	66"W x 14"D x 0,7"H	56.US001.01.066.02	1,21	1	\$260,00
	72"W x 14"D x 0,7"H	56.US001.01.072.02	1,34	1	\$275,00

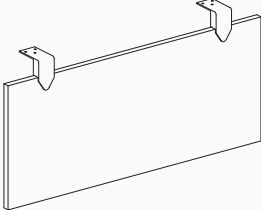
	DESCRIPTION	MODEL CODE	CUBE ft ³	Number of Packed	Price
	Motto Modesty Panel For L-Station				
	32"W x 14"D x 0,7"H	56.US001.01.001.01	0,74	1	\$210,00

MOTTO

CREDENZA

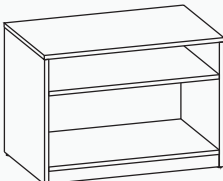
	DESCRIPTION	MODEL CODE	CUBE ft ³	Number of Packed	Price
	Motto Low Credenza 30" – O 30"W x 20"D x 21,5"H	56.US000.04.030.01	9,13	1	\$650,00

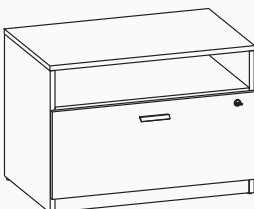
	DESCRIPTION	MODEL CODE	CUBE ft ³	Number of Packed	Price
	Motto Low Credenza 30" – OF 30"W x 20"D x 21,5"H	56.US000.04.030.02	9,13	1	\$830,00

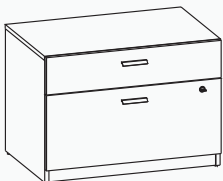
	DESCRIPTION	MODEL CODE	CUBE ft ³	Number of Packed	Price
	Motto Low Credenza 30" – BF 30"W x 20"D x 21,5"H	56.US000.04.030.03	9,13	1	\$930,00

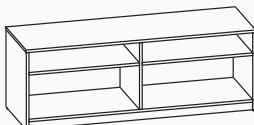
	DESCRIPTION	MODEL CODE	CUBE ft ³	Number of Packed	Price
	Motto Low Credenza 60" – O 60"W x 20"D x 21,5"H	56.US000.04.060.01	17,69	1	\$1.120,00

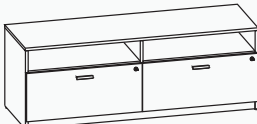
	DESCRIPTION	MODEL CODE	CUBE ft ³	Number of Packed	Price
	Motto Low Credenza 60" – OF 60"W x 20"D x 21,5"H	56.US000.04.060.02	17,69	1	\$1.465,00

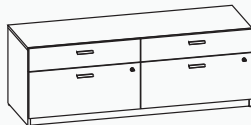
	DESCRIPTION	MODEL CODE	CUBE ft ³	Number of Packed	Price
	Motto Low Credenza 60" – BF 60"W x 20"D x 21,5"H	56.US000.04.060.03	17,69	1	\$1.770,00

MOTTO

OVERHEAD

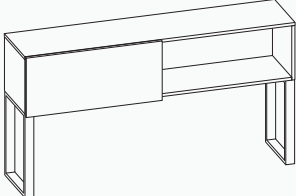
	DESCRIPTION	MODEL CODE	CUBE ft ³	Number of Packed	Price
	Motto O Leg Supported Overhead Cabinet With One Sliding Door	56.US001.03.060.02	10,68	1	\$1.155,00
	60"W x 14,25"D x 34,5"H				

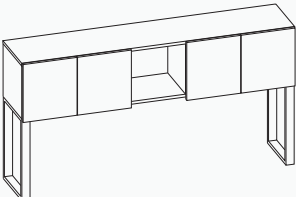
	DESCRIPTION	MODEL CODE	CUBE ft ³	Number of Packed	Price
	Motto O Leg Supported Overhead Cabinet With Four Door 66"/72"	56.US001.03.066.02	11,77	1	\$1.240,00
	66"W x 14,25"D x 34,5"H	56.US001.03.072.02	12,79	1	\$1.305,00
	72"W x 14,25"D x 34,5"H				

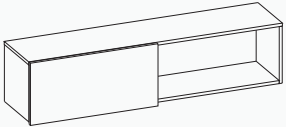
	DESCRIPTION	MODEL CODE	CUBE ft ³	Number of Packed	Price
	Motto Overhead Cabinet With One Sliding Door	56.US001.03.060.01	9,09	1	\$815,00
	60"W x 14,25"D x 14"H				

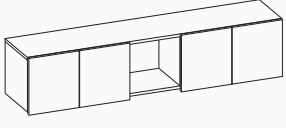
	DESCRIPTION	MODEL CODE	CUBE ft ³	Number of Packed	Price
	Motto Overhead Cabinet With Four Door 66"/72"	56.US001.03.066.01	10,02	1	\$905,00
	66"W x 14,25"D x 14"H	56.US001.03.072.01	10,89	1	\$965,00
	72"W x 14,25"D x 14"H				

MOTTO

PEDESTAL / SUPPORTS

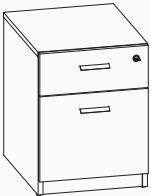
	DESCRIPTION Motto Pedestal BF 16"W x 20"D x 21,5"H	MODEL CODE 56.US000.08.016.01	CUBE ft³ 5,24	Number of Packed 1	Price \$660,00
---	--	---	--	--	--------------------------

	DESCRIPTION Motto Pedestal BBB 16"W x 20"D x 21,5"H	MODEL CODE 56.US000.08.016.02	CUBE ft³ 5,24	Number of Packed 1	Price \$700,00
--	---	---	--	--	--------------------------

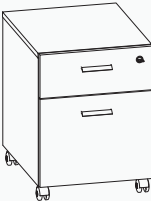
	DESCRIPTION Motto Mobile Pedestal With Casters BF 16"W x 20"D x 21,5"H	MODEL CODE 56.US000.08.016.03	CUBE ft³ 5,24	Number of Packed 1	Price \$680,00
---	--	---	--	--	--------------------------

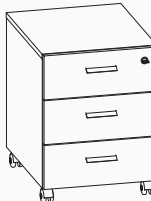
	DESCRIPTION Motto Mobile Pedestal With Casters BBB 16"W x 20"D x 21,5"H	MODEL CODE 56.US000.08.016.04	CUBE ft³ 5,24	Number of Packed 1	Price \$715,00
---	---	---	--	--	--------------------------

MOTTO

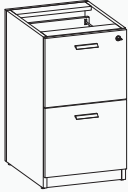
	DESCRIPTION	MODEL CODE	CUBE ft ³	Number of Packed	Price
	Motto Support Pedestal FF 16"W x 20"D x 28,8"H	56.US000.05.016.02	6,73	1	\$810,00

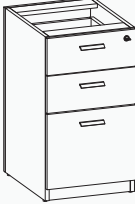
	DESCRIPTION	MODEL CODE	CUBE ft ³	Number of Packed	Price
	Motto Support Pedestal BBF 16"W x 20"D x 28,8"H	56.US000.05.016.01	6,73	1	\$850,00

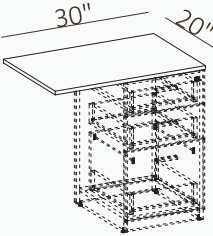
	DESCRIPTION	MODEL CODE	CUBE ft ³	Number of Packed	Price
	Motto Side Worksurface For Pedestal 30" / 36" / 42" 30"W x 20"D x 0,7"H	56.US000.98.030.01	0,93	1	\$165,00
	36"W x 20"D x 0,7"H	56.US000.98.036.01	1,11	1	\$185,00
	42"W x 20"D x 0,7"H	56.US000.98.042.01	1,28	1	\$200,00

MOTTO

DRESS CABINET / STORAGE

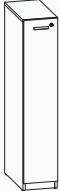
	DESCRIPTION Motto Low Dress Cabinet 10" 10"W x 20"D x 50"H	MODEL CODE 56.US001.03.050.01	CUBE ft³ 7,69	Number of Packed 1	Price \$640,00
---	--	---	--	--	--------------------------

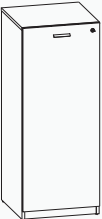
	DESCRIPTION Motto Low Dress Cabinet 20" 20"W x 20"D x 50"H	MODEL CODE 56.US001.03.050.02	CUBE ft³ 14,36	Number of Packed 1	Price \$1.000,00
--	--	---	---	--	----------------------------

	DESCRIPTION Motto High Dress Cabinet 10" 10"W x 20"D x 56"H	MODEL CODE 56.US001.03.056.01	CUBE ft³ 8,57	Number of Packed 1	Price \$700,00
---	---	---	--	--	--------------------------

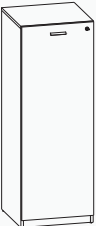
	DESCRIPTION Motto High Dress Cabinet 20" 20"W x 20"D x 56"H	MODEL CODE 56.US001.03.056.02	CUBE ft³ 15,99	Number of Packed 1	Price \$1.060,00
---	---	---	---	--	----------------------------

MOTTO

	DESCRIPTION	MODEL CODE	CUBE ft³	Number of Packed	Price
	Motto Storage Left Hand Drawers Right Hand Door 26"W x 20"D x 56"H	56.US001.03.026.01R	22,03	3	\$2.050,00

	DESCRIPTION	MODEL CODE	CUBE ft³	Number of Packed	Price
	Motto Storage Right Hand Drawers Left Hand Door 26"W x 20"D x 56"H	56.US001.03.026.01L	22,03	3	\$2.050,00

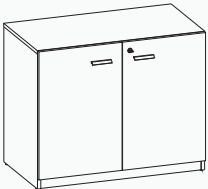
	DESCRIPTION	MODEL CODE	CUBE ft³	Number of Packed	Price
	Motto Two Door Storage Cabinet 36"W x 20"D x 29,5"H	56.US001.03.036.01	14,92	1	\$1.120,00

	DESCRIPTION	MODEL CODE	CUBE ft³	Number of Packed	Price
	Motto Two Drawer Lateral File 36"W x 20"D x 29,5"H	56.US000.04.036.01	14,92	1	\$1.350,00

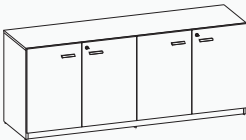
	DESCRIPTION	MODEL CODE	CUBE ft³	Number of Packed	Price
	Motto Four Door Storage Cabinet 72"W x 20"D x 29,5"H	56.US001.03.072.03	29,21	1	\$2.060,00

MOTTO

DIVIDERS

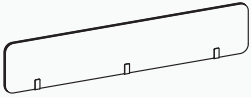
	DESCRIPTION	MODEL CODE	CUBE ft ³	Number of Packed	Price
	SP 01 Desk Divider 60" / 66" / 72"				
	60"W x 12"H	56.US801.05.152.01	1,16	1	\$280,00
	66"W x 12"H	56.US801.05.168.01	1,28	1	\$300,00
	72"W x 12"H	56.US801.05.182.01	1,39	1	\$320,00

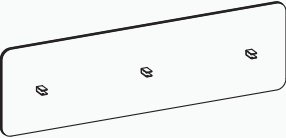
	DESCRIPTION	MODEL CODE	CUBE ft ³	Number of Packed	Price
	SP 02 Desk Divider 60" / 66" / 72"				
	60"W x 18"H	56.US801.05.152.02	1,66	1	\$380,00
	66"W x 18"H	56.US801.05.168.02	1,83	1	\$400,00
	72"W x 18"H	56.US801.05.182.02	1,98	1	\$420,00

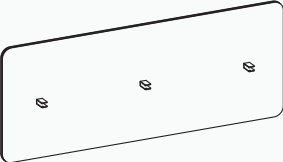
	DESCRIPTION	MODEL CODE	CUBE ft ³	Number of Packed	Price
	SP 03 Desk Divider 60" / 66" / 72"				
	60"W x 24"H	56.US801.05.152.03	2,16	1	\$455,00
	66"W x 24"H	56.US801.05.168.03	2,38	1	\$475,00
	72"W x 24"H	56.US801.05.182.03	2,58	1	\$520,00

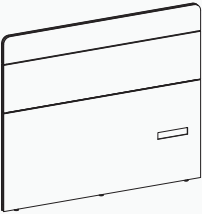

	DESCRIPTION	MODEL CODE	CUBE ft ³	Number of Packed	Price
	Fixed Divider Panel 60" / 66" / 72"				
	60"W x 52"H	56.US801.05.060.01	5,99	1	\$1.065,00
	66"W x 52"H	56.US801.05.66.01	6,60	1	\$1.155,00
	72"W x 52"H	56.US801.05.72.01	7,13	1	\$1.250,00

MOTTO

METAL ACCESSORIES / ELECTRICAL SET

	<p>DESCRIPTION</p> <p>ASK 01 Hanger 14"W x 1"D x 6"H</p>	<p>MODEL CODE</p> <p>56.US801.08.037.01</p>	<p>CUBE ft³</p> <p>0,09</p>	<p>Number of Packed</p> <p>1</p>	<p>Price</p> <p>\$70,00</p>
	<p>DESCRIPTION</p> <p>RF 01 Metal Shelf (for Desk Divider) 8,5"W x 5"D x 4"H</p>	<p>MODEL CODE</p> <p>56.US801.07.022.03</p>	<p>CUBE ft³</p> <p>0,10</p>	<p>Number of Packed</p> <p>1</p>	<p>Price</p> <p>\$65,00</p>
	<p>DESCRIPTION</p> <p>RF 02 Metal Shelf (for fixed Divider panel) 8,5"W x 5"D x 4"H</p>	<p>MODEL CODE</p> <p>56.US801.07.022.04</p>	<p>CUBE ft³</p> <p>0,10</p>	<p>Number of Packed</p> <p>1</p>	<p>Price</p> <p>\$65,00</p>
	<p>DESCRIPTION</p> <p>RF 03 Metal Shelf Pencil Case (for Desk Divider) 8,5"W x 5"D x 8,5"H</p>	<p>MODEL CODE</p> <p>56.US801.07.022.01</p>	<p>CUBE ft³</p> <p>0,22</p>	<p>Number of Packed</p> <p>1</p>	<p>Price</p> <p>\$105,00</p>
	<p>DESCRIPTION</p> <p>RF 04 Metal Shelf Pencil Case (for fixed Divider panel) 8,5"W x 5"D x 8,5"H</p>	<p>MODEL CODE</p> <p>56.US801.07.022.05</p>	<p>CUBE ft³</p> <p>0,22</p>	<p>Number of Packed</p> <p>1</p>	<p>Price</p> <p>\$105,00</p>
	<p>DESCRIPTION</p> <p>RF 05 Metal Shelf File Holder (for Desk Divider) 12,5"W x 5"D x 8,5"H</p>	<p>MODEL CODE</p> <p>56.US801.07.022.02</p>	<p>CUBE ft³</p> <p>0,32</p>	<p>Number of Packed</p> <p>1</p>	<p>Price</p> <p>\$120,00</p>
	<p>DESCRIPTION</p> <p>RF 06 Metal Shelf File Holder (for fixed Divider panel) 12,5"W x 5"D x 8,5"H</p>	<p>MODEL CODE</p> <p>56.US801.07.022.06</p>	<p>CUBE ft³</p> <p>0,32</p>	<p>Number of Packed</p> <p>1</p>	<p>Price</p> <p>\$120,00</p>

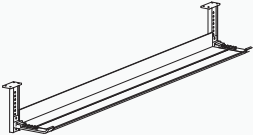
MOTTO

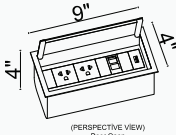
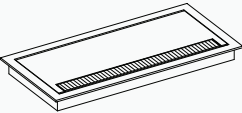
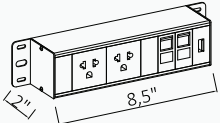
	<p>DESCRIPTION</p> <p>Aluminium Cable Tray</p> <p>42"W x 6"D x 5,5"H</p>	<p>MODEL CODE</p> <p>56.US825.17.000.02</p>	<p>CUBE ft³</p> <p>0,67</p>	<p>Number of Packed</p> <p>1</p>	<p>Price</p> <p>\$160,00</p>
	<p>DESCRIPTION</p> <p>Plastic Cable Spine</p> <p>4"ØW x 29,5"H</p>	<p>MODEL CODE</p> <p>56.US825.17.000.01</p>	<p>CUBE ft³</p> <p>0,32</p>	<p>Number of Packed</p> <p>1</p>	<p>Price</p> <p>\$65,00</p>
 <p>(PERSPECTIVE VIEW) Door Open</p>	<p>DESCRIPTION</p> <p>Plug Set for desk</p> <p>9"W x 4"D x 4"H</p>	<p>MODEL CODE</p> <p>56.US825.17.000.03</p>	<p>CUBE ft³</p> <p>0,24</p>	<p>Number of Packed</p> <p>1</p>	<p>Price</p> <p>\$310,00</p>
	<p>DESCRIPTION</p> <p>Aluminium Plug Cover for Desks</p> <p>9"W x 4"D x 2"H</p>	<p>MODEL CODE</p> <p>56.US825.17.000.04</p>	<p>CUBE ft³</p> <p>0,24</p>	<p>Number of Packed</p> <p>1</p>	<p>Price</p> <p>\$130,00</p>
	<p>DESCRIPTION</p> <p>Plug Set for Fixed Divider</p> <p>8,5"W x 2"D x 2"H</p>	<p>MODEL CODE</p> <p>56.US825.17.000.05</p>	<p>CUBE ft³</p> <p>0,11</p>	<p>Number of Packed</p> <p>1</p>	<p>Price</p> <p>\$230,00</p>

MOTTO

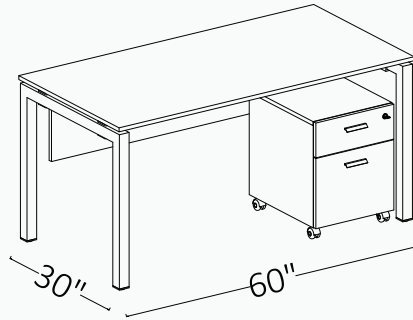

SET 1

QTY	DESCRIPTION	MODEL CODE	LIST PRICE	PRICE EXTENSION
1	Motto US 01 Two Leg 60"	56.US001.01.060.01	\$790,00	\$790,00
1	Motto Modesty Panel 60"	56.US001.01.060.02	\$240,00	\$240,00
1	Motto Mobile Pedestal With Caster BF	56.US000.08.016.03	\$680,00	\$680,00

TOTAL \$1.710,00

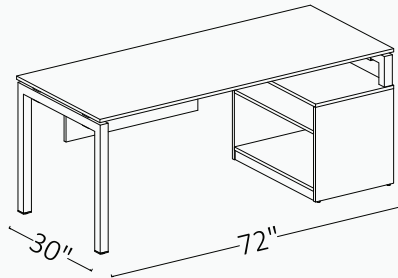

SET 2

QTY	DESCRIPTION	MODEL CODE	LIST PRICE	PRICE EXTENSION
1	Motto US 02 Single Leg 72"	56.US002.01.072.01	\$840,00	\$840,00
1	Motto Modesty Panel For L-Station	56.US001.01.001.01	\$210,00	\$210,00
1	Motto Low Credenza 30"-O	56.US000.04.030.01	\$650,00	\$650,00

TOTAL \$1.700,00

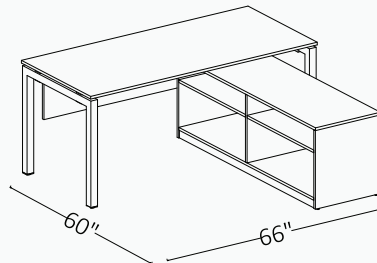

SET 3

QTY	DESCRIPTION	MODEL CODE	LIST PRICE	PRICE EXTENSION
1	Motto US 01 Two Leg 66"	56.US001.01.066.01	\$830,00	\$830,00
1	Motto Modesty Panel 66"	56.US001.01.066.02	\$260,00	\$260,00
1	Motto Low Credenza 60"-O	56.US000.04.060.01	\$1.120,00	\$1.120,00

TOTAL \$2.210,00

MOTTO

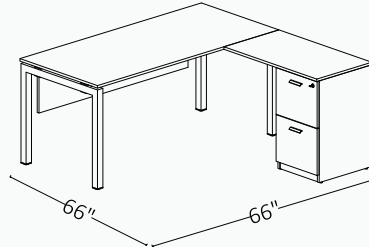

SET 4

QTY	DESCRIPTION	MODEL CODE	LIST PRICE	PRICE EXTENSION
1	Motto US 01 Two Leg 66"	56.US001.01.066.01	\$830,00	\$830,00
1	Motto Modesty Panel 66"	56.US001.01.066.02	\$260,00	\$260,00
1	Motto Side Worksurface For Support Pedestal 36"	56.US000.98.036.01	\$185,00	\$185,00
1	Motto Support Pedestal FF	56.US000.05.016.02	\$810,00	\$810,00

TOTAL \$2.085,00

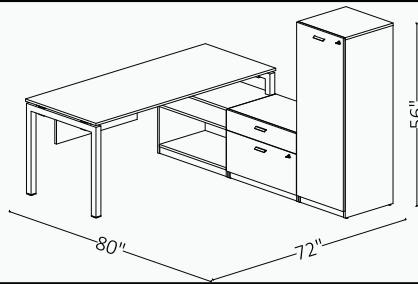

SET 5

QTY	DESCRIPTION	MODEL CODE	LIST PRICE	PRICE EXTENSION
1	Motto US 01 Two Leg 72"	56.US001.01.072.01	\$875,00	\$875,00
1	Motto Modesty Panel For L-Station	56.US001.01.001.01	\$210,00	\$210,00
1	Motto Low Credenza 30"-O	56.US000.04.030.01	\$650,00	\$650,00
1	Motto Low Credenza 30"-BF	56.US000.04.030.03	\$930,00	\$930,00
1	Motto High Dress Cabinet 20"	56.US001.03.056.02	\$1.060,00	\$1.060,00

TOTAL \$3.725,00

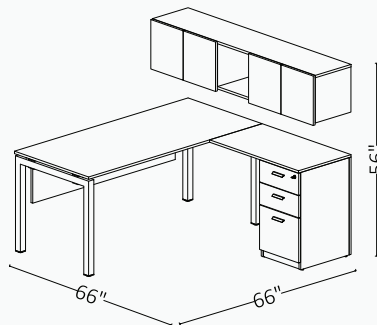

SET 6

QTY	DESCRIPTION	MODEL CODE	LIST PRICE	PRICE EXTENSION
1	Motto US 01 Two Leg 66"	56.US001.01.066.01	\$830,00	\$830,00
1	Motto Modesty Panel 66"	56.US001.01.066.02	\$260,00	\$260,00
1	Motto Side Worksurface For Pedestal 36"	56.US000.98.036.01	\$185,00	\$185,00
1	Motto Support Pedestal BBF	56.US000.05.016.01	\$850,00	\$850,00
1	Motto Overhead Cabinet With Four Door 66"	56.US001.03.066.01	\$905,00	\$905,00

TOTAL \$3.030,00

MOTTO

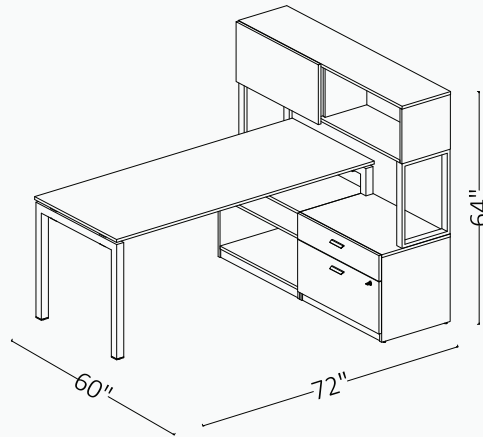

SET 7

QTY	DESCRIPTION	MODEL CODE	LIST PRICE	PRICE EXTENSION
1	Motto US 02 Single Leg 72"	56.US002.01.072.01	\$840,00	\$840,00
1	Motto Low Credenza 30" – O	56.US000.04.030.01	\$650,00	\$650,00
1	Motto Low Credenza 30"– BF	56.US000.04.030.03	\$930,00	\$930,00
1	Motto O Leg Supported Overhead Cabinet With One Sliding Door	56.US001.03.060.02	\$1.155,00	\$1.155,00

TOTAL \$3.575,00

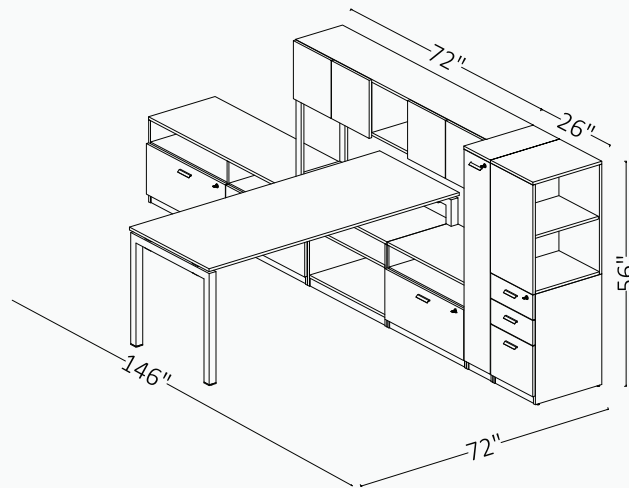

SET 8

QTY	DESCRIPTION	MODEL CODE	LIST PRICE	PRICE EXTENSION
1	Motto US 02 Single Leg 72"	56.US002.01.072.01	\$840,00	\$840,00
1	Motto Low Credenza 30"– O	56.US000.04.030.01	\$650,00	\$650,00
1	Motto Low Credenza 30"– BF	56.US000.04.030.03	\$930,00	\$930,00
1	Motto Low Credenza 60"– OF	56.US000.04.060.02	\$1.465,00	\$1.465,00
1	Motto O Leg Supported Overhead Cabinet With Four Door 72"	56.US001.03.072.02	\$1.305,00	\$1.305,00
1	Motto Storage Left Hand Drawer Right Hand Door	56.US001.03.026.01R	\$2.050,00	\$2.050,00

TOTAL \$7.240,00

MOTTO

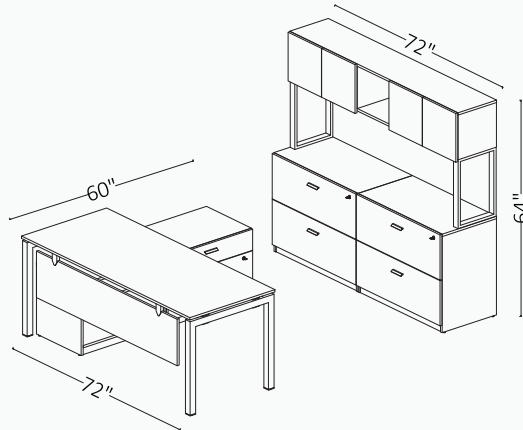

SET 9

QTY	DESCRIPTION	MODEL CODE	LIST PRICE	PRICE EXTENSION
1	Motto US 01 Two Leg 72"	56.US001.01.072.01	\$875,00	\$875,00
1	Motto Low Credenza 30"—O	56.US000.04.030.01	\$650,00	\$650,00
1	Motto Low Credenza 30"—BF	56.US000.04.030.03	\$930,00	\$930,00
2	Motto Two Drawer Lateral File	56.US000.04.036.01	\$1.350,00	\$2.700,00
1	Motto O Leg Supported Overhead Cabinet With Four Door 72"	56.US001.03.072.02	\$1.305,00	\$1.305,00

TOTAL \$6.460,00

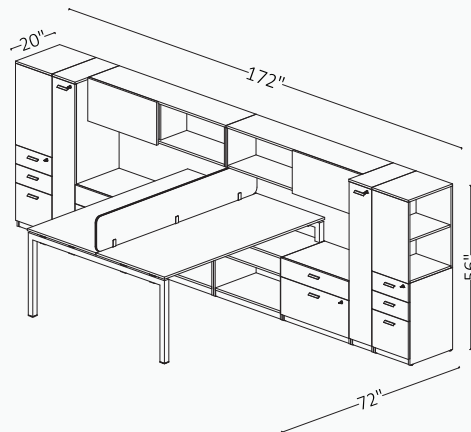

SET 10

QTY	DESCRIPTION	MODEL CODE	LIST PRICE	PRICE EXTENSION
1	Motto US 05 Workstation Single Leg 72"	56.US005.01.072.01	\$1.500,00	\$1.500,00
1	SP 01 Desk Divider 72"	56.US801.05.182.01	\$320,00	\$320,00
2	Motto Low Credenza 30"—O	56.US000.04.030.01	\$650,00	\$1.300,00
2	Motto Low Credenza 30"—BF	56.US000.04.030.03	\$930,00	\$1.860,00
1	Motto Storage Left Hand Drawer Right Hand Door	56.US001.03.026.01R	\$2.050,00	\$2.050,00
1	Motto Storage Right Hand Drawer Left Hand Door	56.US001.03.026.01L	\$2.050,00	\$2.050,00
2	Motto Overhead Cabinet With One Sliding Door	56.US001.03.060.01	\$815,00	\$1.630,00

TOTAL \$10.710,00

MOTTO

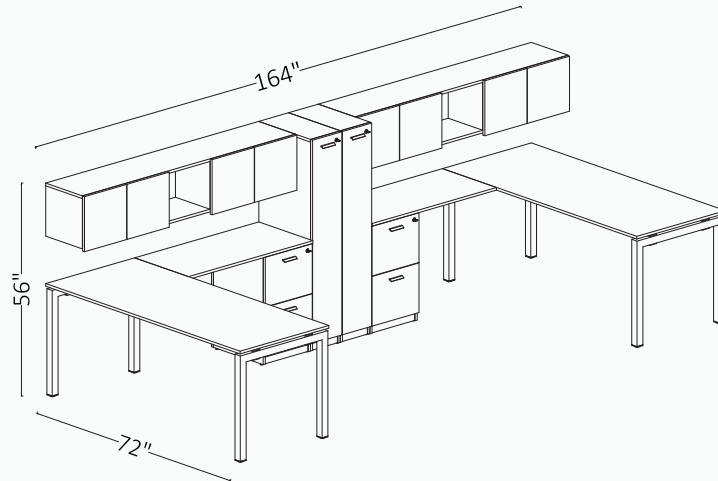

SET 11

QTY	DESCRIPTION	MODEL CODE	LIST PRICE	PRICE EXTENSION
2	Motto US 01 Two Leg 72"	56.US001.01.072.01	\$875,00	\$1.750,00
2	Motto Side Worksurface For Pedestal 42"	56.US000.98.042.01	\$200,00	\$400,00
2	Motto Support Pedestal FF	56.US000.05.016.02	\$810,00	\$1.620,00
2	Motto High Dress Cabinet 10"	56.US001.03.056.01	\$700,00	\$1.400,00
2	Motto Overhead Cabinet With Four Door 72"	56.US001.03.072.01	\$965,00	\$1.930,00

TOTAL \$7.100,00

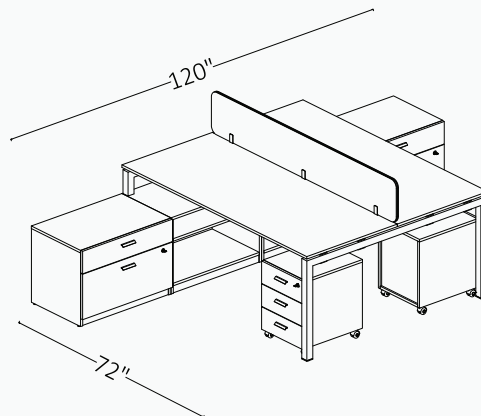

SET 12

QTY	DESCRIPTION	MODEL CODE	LIST PRICE	PRICE EXTENSION
1	Motto US 05 Workstation Single Leg 72"	56.US005.01.072.01	\$1.500,00	\$1.500,00
1	SP 01 Desk Divider 72"	56.US801.05.182.01	\$320,00	\$320,00
2	Motto Low Credenza 30"-O	56.US000.04.030.01	\$650,00	\$1.300,00
2	Motto Low Credenza 30"-BF	56.US000.04.030.03	\$930,00	\$1.860,00
2	Motto Mobile Pedestal With Caster BF	56.US000.08.016.01	\$660,00	\$1.320,00

TOTAL \$6.300,00

MOTTO

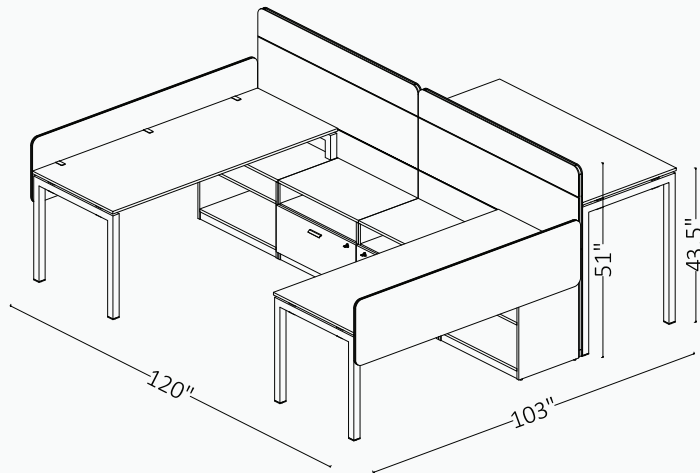

SET 13

QTY	DESCRIPTION	MODEL CODE	LIST PRICE	PRICE EXTENSION
2	Motto US 02 Single Leg 72"	56.US002.01.072.01	\$840,00	\$1.680,00
2	SP 02 Desk Divider 72"	56.US801.05.182.02	\$420,00	\$840,00
2	Motto Low Credenza 30"—O	56.US000.04.030.01	\$650,00	\$1.300,00
2	Motto Low Credenza 30"—OF	56.US000.04.030.02	\$830,00	\$1.660,00
2	Fixed Divider Panel 60"	56.US801.05.060.01	\$1.065,00	\$2.130,00
1	Motto US 03 High Leg 60"	56.US003.01.060.01	\$1.010,0	\$1.010,0
			TOTAL	\$8.620,00

COMMON AREA



Products we designed for common areas; to make your work area in the office more convenient, thanks to our modular coffee tables, our trolley and all the other ones

COMMON AREA

Statement of Line

MOBILE FURNITURE

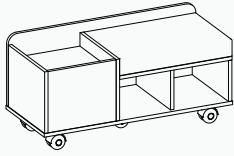

BNK 01 Mobile Bench

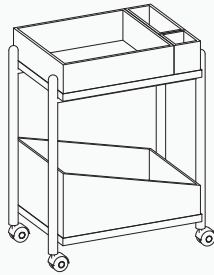

DYS 01 File Trolley

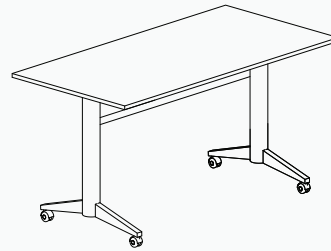

Folding Table
60" / 66" / 72"

MOBILE DIVIDER PANEL

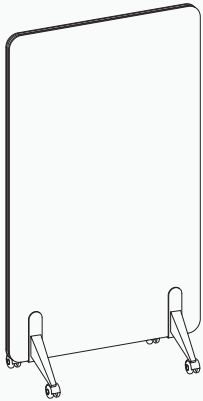

BP 01
Mobile Divider Panel



BP 02
Mobile Divider Panel

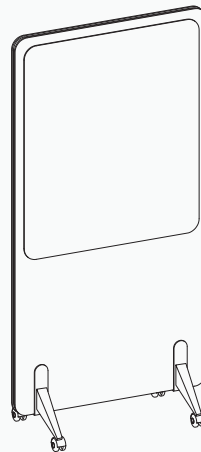

BP 03 Mobile Divider
Panel With Chalkboard

SHELF VARIATIONS

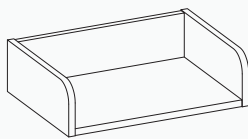

CD 01 Shelf

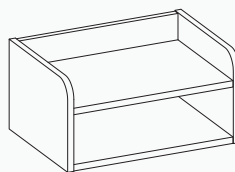

CD 02 Open Shelf

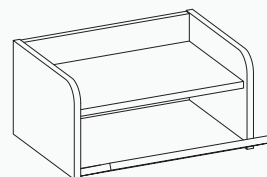

CD 03 Shelf With Door

BNK 01 Bench : Melamine surfaced panel is used as BNK01 Bench panel material. Panel material thickness is 0.07". Fabric upholstered foam is used as cushion. Mobile with its casters.

DYS 01 File Trolley : The boxes on the DYS 01 file trolley are removable and lacquered. It has an entire skeleton with metal tube legs. Mobile with its casters.

Folding Table : UV lacquer panels and melamine surface panels are used as table material. The plate thickness is 0.07". The desk edges are PVC coated and can be folded and stacked inside each other. Within its plastic connection brackets, the tables can be used side by side and fixed to each other.

Mobile Divider Panels : Made of 1st Class Raw MDF and fabric upholstered. Mobile with its casters. The casters are made of specially twisted sheet metal material, electrostatic powder coated and covered with natural wood.

BP 03 Mobile Divider Panel : One side of the Mobile Divider has 0,16" Opaque Glass to use as a chalkboard.

CD 01 – CD 02 – CD 03 shelf modules are used between BP 01 and BP 02 Divider Panels. The assembly of these shelf modules are done by attaching them within the hanging brackets.

COMMON AREA

COFFEE TABLES

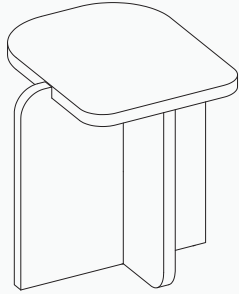

OSP 01 Coffee Table

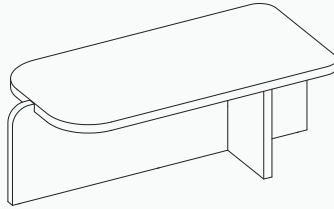

OSP 02 Coffee Table

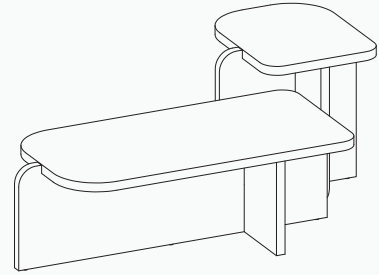

**OSP 01 - OSP 02
Coffee Table**

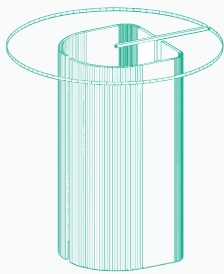

**MSP 01 Metal Side
Coffee Table**

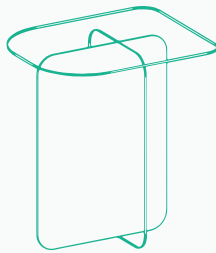

**MSP 02 Metal Side
Coffee Table**



**MSP 01 - MSP 02
Coffee Table**

OSP 01 and OSP 02 Coffee Tables : UV lacquer panel and melamine surface panel as panel materials. The plate thickness is 0.07". The edges of the top table are radiused. All visible edges are PVC coated. Can be used separately or as a two-in-one set.

MSP 01 and MSP 02 Metal Side Coffee Tables : Made of 0.2" thick sheet metal material and electrostatic powder coated.

Within the channels of the MSP 01 Coffee Table, the Coffee Tables can be interconnected or can be used separately or as a two-in-one set.

COMMON AREA

MOBILE FURNITURE

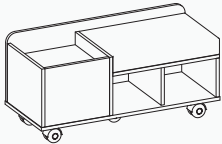
	DESCRIPTION	MODEL CODE	CUBE ft ³	Number of Packed	Price
	BNK 01 Mobile Bench 39"W x 16,5"D x 20"H	56.US801.04.100.02	7,67	1	\$820,00

	DESCRIPTION	MODEL CODE	CUBE ft ³	Number of Packed	Price
	DYS 01 File Trolley 16"W x 23"D x 30"H	56.US801.08.040.01	7,85	1	\$1.870,00

	DESCRIPTION	MODEL CODE	CUBE ft ³	Number of Packed	Price
	Folding Table 60" / 66" / 72" 60"W x 30"D x 29,5"H	56.US166.00.140.01	8,80	2	\$1.400,00
	66"W x 30"D x 29,5"H	56.US166.00.140.02	9,31	2	\$1.460,00
	72"W x 30"D x 29,5"H	56.US166.00.140.03	9,83	2	\$1.550,00

	DESCRIPTION	MODEL CODE	CUBE ft ³	Number of Packed	Price
	BP 01 Mobile Divider Panel 31,5"W x 17"D x 55"H	56.US801.05.140.01	4,35	2	\$880,00

	DESCRIPTION	MODEL CODE	CUBE ft ³	Number of Packed	Price
	BP 02 Mobile Divider Panel 31,5"W x 17"D x 62"H	56.US801.05.160.01	4,83	2	\$970,00

	DESCRIPTION	MODEL CODE	CUBE ft ³	Number of Packed	Price
	BP 03 Mobile Divider Panel With Chalkboard 31,5"W x 17"D x 62"H	56.US801.08.062.01	4,83	2	\$1.340,00

COMMON AREA

SHELF VARIATIONS

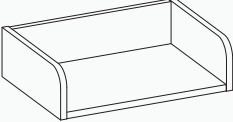
	DESCRIPTION	MODEL CODE	CUBE ft ³	Number of Packed	Price
	CD 01 Shelf 20"W x 14"D x 5,5"H	56.US801.08.050.01	1,48	1	\$145,00

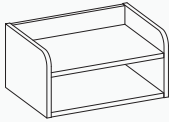
	DESCRIPTION	MODEL CODE	CUBE ft ³	Number of Packed	Price
	CD 02 Open Shelf 20"W x 14"D x 10"H	56.US801.08.050.02	2,33	1	\$230,00

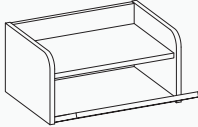
	DESCRIPTION	MODEL CODE	CUBE ft ³	Number of Packed	Price
	CD 03 Shelf With Door 20"W x 14"D x 10"H	56.US801.08.050.04	2,33	1	\$255,00

COFFEE TABLES

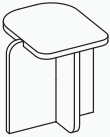
	DESCRIPTION	MODEL CODE	CUBE ft ³	Number of Packed	Price
	OSP 01 Coffee Table 19"W x 20"D x 20"H	56.US801.06.48.01	5,66	1	\$395,00

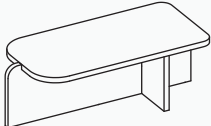
	DESCRIPTION	MODEL CODE	CUBE ft ³	Number of Packed	Price
	OSP 02 Coffee Table 42,5"W x 20"D x 14"H	56.US801.06.108.01	8,93	1	\$580,00

	DESCRIPTION	MODEL CODE	CUBE ft ³	Number of Packed	Price
	MSP 01 Metal Side Coffee Table 16"W x 16"D x 15"H	56.US801.06.040.01	3,22	1	\$450,00

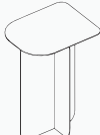
	DESCRIPTION	MODEL CODE	CUBE ft ³	Number of Packed	Price
	MSP 02 Metal Side Coffee Table 16"W x 20"D x 21,5"H	56.US801.08.040.02	5,24	1	\$640,00

COMMON AREA

SET VARIATIONS

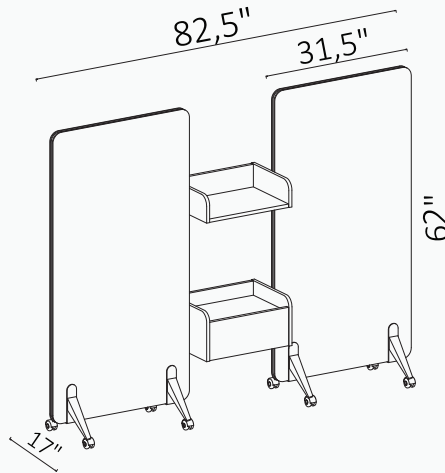

SET 1

QTY	DESCRIPTION	MODEL CODE	LIST PRICE	PRICE EXTENSION
2	BP 02 Mobile Divider Panel	56.US801.05.160.01	\$970,00	\$1.940,00
1	CD 01 Shelf	56.US801.08.050.01	\$145,00	\$145,00
1	CD 03 Shelf With Door	56.US801.08.050.04	\$255,00	\$255,00

TOTAL \$2.340,00

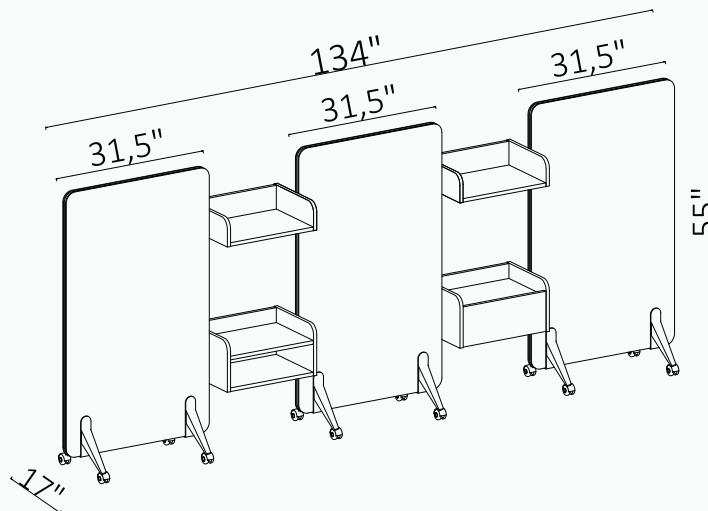

SET 2

QTY	DESCRIPTION	MODEL CODE	LIST PRICE	PRICE EXTENSION
3	BP 01 Mobile Divider Panel	56.US801.05.140.01	\$880,00	\$2.640,00
2	CD 01 Shelf	56.US801.08.050.01	\$145,00	\$290,00
1	CD 02 Open Shelf	56.US801.08.050.02	\$230,00	\$230,00
1	CD 03 Shelf With Door	56.US801.08.050.04	\$255,00	\$255,00

TOTAL \$3.415,00

BLACK



Step into the realm of sophistication with our elegant executive office set. Crafted with meticulous attention to detail, each piece exudes timeless charm and professional flair. It provides you two working area within the desk and the special design cabinet.

Elevate your workspace to new heights of elegance and productivity with this distinguished collection.

BLACK

Statement of Line

PRIVATE SET

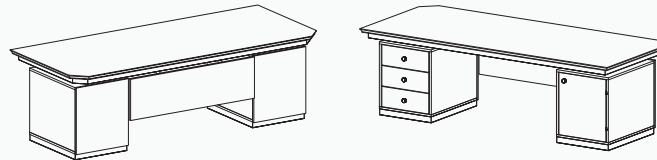

Black Private Desk

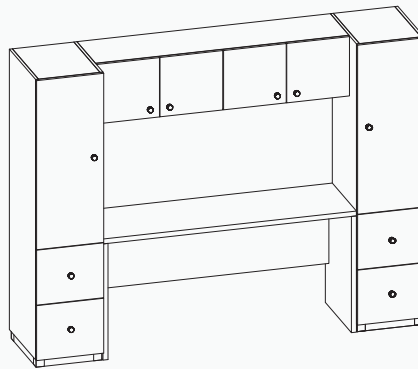

Black Private High Cabinet

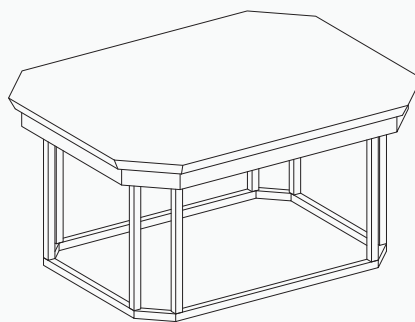

Black Private Coffee Table

The Black Private Set has two work areas.

The desk top, modesty panel and coffee table top are MDF and painted with Zero Gloss Lacquer.

Melamine surfaced panels are used for the other parts. All visible edges are PVC taped.

The drawers of the desk are with telescopic rails with brake system.

Soft-closing hinges are used on all doors of the desk and cabinet, and there are mobile shelves inside the cabinet.

The modesty panel is mounted to the desk within a metal fastener.

The private high cabinet has a card index and its rails are telescopic and with brakes.

There is also a second work area in the middle section of the high cabinet.

One of the tall wardrobes has a hanger for your clothes and the other has a mobile shelf.

The metal leg of the coffee table is electrostatic powder coated box profile.

PRIVATE SET

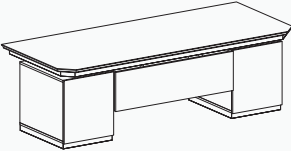
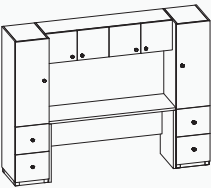
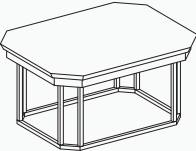
	DESCRIPTION	MODEL CODE	CUBE ft³	Number of Packed	Price
	Black Private Desk 94,5"W x 35,5"D x 29,5"H	56.US182.01.240.01	27,50	4	\$6.500,00
	DESCRIPTION	MODEL CODE	CUBE ft³	Number of Packed	Price
	Black Private High Cabinet 92"W x 20"D x 70"H	56.US182.03.234.01	49,00	4	\$4.450,00
	DESCRIPTION	MODEL CODE	CUBE ft³	Number of Packed	Price
	Black Private Coffee Table 35,5"W x 27,5"D x 18"H	56.US182.06.90.01	8,50	2	\$1.230,00



BLACK

PRIVATE SET

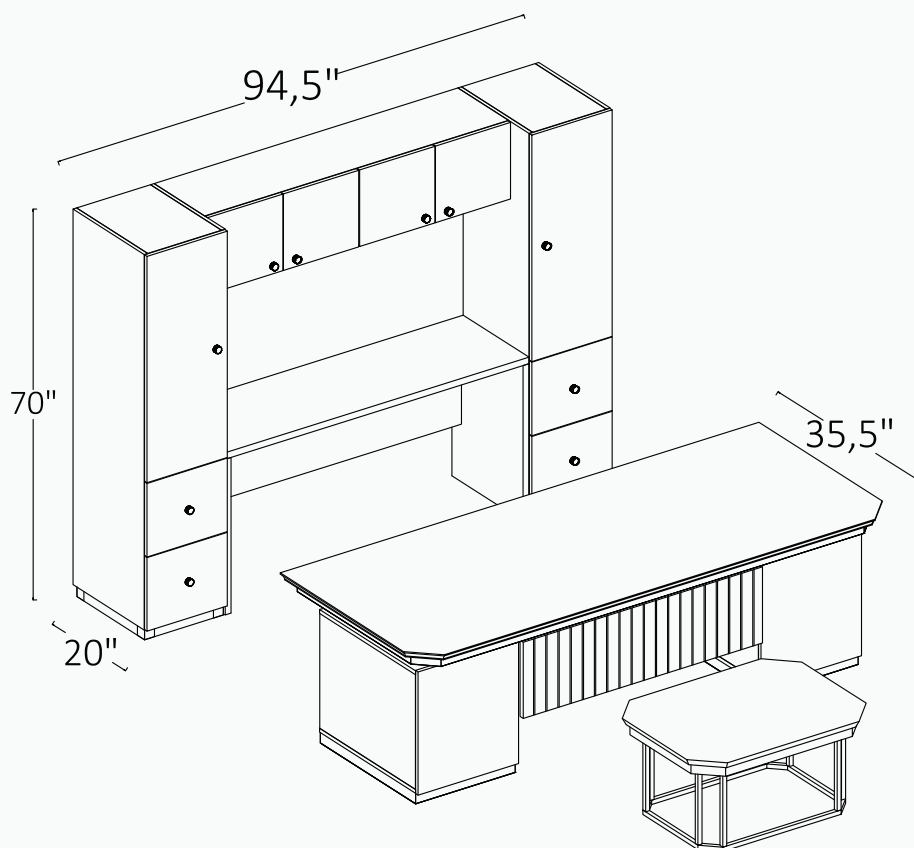

QTY	DESCRIPTION	MODEL CODE	LIST PRICE	PRICE EXTENSION
1	Black Private Desk	56.US182.01.240.01	\$4.500,00	\$6.500,00
1	Black Private High Cabinet	56.US182.03.234.01	\$2.800,00	\$4.450,00
1	Black Private Coffee Table	56.US182.06.90.01	\$900,00	\$1.230,00

TOTAL \$12.180,00



goldsit
Always **Reachable**

goldsit
OFFICEFURNITURE

goldsit.us