

ASW ALPHA™

Rod-based, wire-wrapped sand screens for water well, environmental and industrial applications

The Alpha rod-based, wedge-wire wrapped, all-welded sand screen provides more open area than any other well-screen design and allows better access to the entire formation. This screen is very versatile and is easily adapted to many types of industrial and water well applications.

The mass of the wrap wire and support rods combined with efficient welding techniques during the manufacturing process dictate the strength and durability of this screen. Our Alpha screens feature an all-welded V-shaped wire that produces a self-

cleaning action for greater flow. The manufacturing process includes a sophisticated, electronically controlled fusion-welding process. These screens are custom-built to exact specifications and expected well conditions using a wide range of alloys. They provide maximum flow area, high well efficiencies and superior tensile strength for dependability and long well life.

The Alpha's continuous slot design allows lower entrance velocity of the water, which reduces encrustation rates. It also helps the screen to resist plugging and prevents sand from damaging pumps.

When considering screens of equal length, diameter and slot size, the Alpha's wire-wrapped design produces flow rates almost three times higher than bridge-slot screens and almost ten times higher than slotted pipe. This greatly enhances well life and filtration capacity. Alpha screens come in a full range of sizes with ODs from 0.75 in. to 24.0 in.

Alloy Screen Works manufactures all products in accordance with the requirements of the ISO 9001:2008 International Standard.



A. Support rods:

the unique structure and number of support rods provide tensile and collapse strength. These rods are of the same material as the wrap wire to prevent electrolytic corrosion when abnormal environmental conditions are present down hole.

B. Screen wrap wire:

V-shaped wire, welded at each junction with a support rod, provides a self-cleaning action for greater flow and less chance of plugging (alloy and dimensions per customer specs). In-plant design and manufacturing of wire shapes ensures that tolerances are within rigid specifications.

C. End fittings:

All standard and custom-made fittings are rigidly secured to the screen body.

Materials of Construction

- Stainless-steel types 304 and 316
- Low carbon steel
- Galvanized steel
- Special alloys.

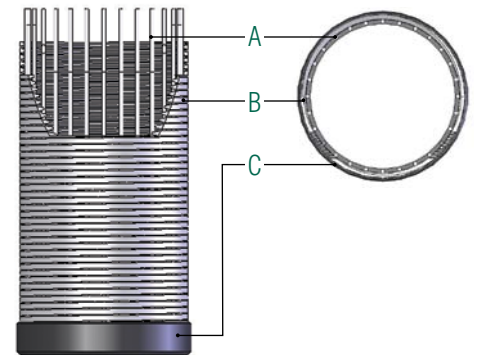

ALLOY SCREEN WORKS

▲▲▲ A division of Alloy Machine Works, Inc.

Flow Characteristics

Pipe Size Nominal (in.)	Telescope Size (in.)	Actual OD (in.)	Clear ID (in.)	Screen Weight* (lb/ft)	Open Area (sq in./ft - screen) Flow Capacity (gal/min/ft @ 0.1 ft/sec entrance velocity) Percent Open Area (%/ft)															
					Screen Slot Size (0.000 in.)															
					8	10	12	20	25	30	35	40	45	50	60	70	80	90	100	
0.75	-	1.05	0.75	0.94	4.57	5.54	6.46	9.66	11.35	12.84	14.18	15.38	16.46	17.44	19.16	20.61	21.84	22.91	23.85	
					1.42	1.72	2.00	2.99	3.52	3.98	4.40	4.77	5.10	5.41	5.94	6.39	6.77	7.10	7.39	
1.00	-	1.32	1.05	1.12	6.01	7.29	8.49	12.71	14.92	16.89	18.65	20.22	21.65	22.94	25.20	27.10	28.72	30.13	31.36	
					1.86	2.26	2.63	3.94	4.63	5.24	5.78	6.27	6.71	7.11	7.81	8.40	8.90	9.34	9.72	
1.25	-	1.66	1.38	2.00	7.40	8.99	10.49	15.73	18.51	20.98	23.18	25.17	26.97	28.60	34.46	33.88	35.96	37.76	39.33	
					2.30	2.79	3.25	4.88	5.74	6.50	7.19	7.80	8.36	8.87	9.75	10.50	11.15	11.70	12.19	
2.00	3.00	2.38	2.07	2.21	12.56	15.24	17.76	26.57	31.21	35.33	39.00	42.29	45.27	37.62	43.89	47.27	50.16	52.67	54.87	
					3.89	4.72	5.51	8.24	9.68	10.95	12.09	13.11	14.03	14.66	13.61	14.65	15.52	16.33	17.00	63
3.00	4.00	3.50	3.07	2.87 (PS) 3.01 (TS)	17.13	20.78	24.22	36.23	42.56	48.17	53.18	57.67	61.73	65.42	71.85	77.27	81.91	85.93	89.43	
					5.31	6.44	7.51	11.23	13.19	14.93	16.49	17.88	19.14	20.28	22.27	23.96	25.39	25.58	26.64	27.72
4.00	5.00	4.75	4.00	3.84 (PS) 3.84 (TS)	21.07	25.59	29.84	44.77	52.67	59.69	65.97	71.63	76.74	81.39	89.53	96.42	102.32	107.44	111.92	
					6.53	7.93	9.25	13.88	16.33	18.50	20.45	22.20	23.79	25.23	27.75	29.99	31.72	33.31	34.69	62
5.00	6.00	5.63	5.00	5.09 (PS) 5.09 (TS)	24.48	30.95	36.11	54.16	63.72	72.20	79.82	86.66	92.12	98.48	108.33	116.63	123.80	129.96	135.41	
					7.90	9.59	11.19	16.79	19.75	22.38	24.75	26.86	29.11	30.52	33.58	36.16	38.38	40.29	41.98	63
6.00	-	6.63	6.00	6.14	20.39	24.97	29.38	45.41	54.29	62.44	69.93	76.85	83.25	89.20	99.90	109.27	117.53	124.88	131.45	
					6.32	7.74	9.12	14.08	16.83	19.35	21.68	23.82	25.81	27.65	30.97	33.87	36.43	38.71	40.75	52
-	8.00	7.50	6.75	6.73	23.08	28.27	30.26	51.41	61.46	70.68	79.16	87.00	94.25	100.98	113.10	123.70	133.05	141.37	148.81	
					7.15	8.76	10.31	15.94	19.05	21.92	24.54	26.97	29.22	31.30	35.06	38.35	41.24	43.82	46.13	52
8.00	-	8.63	8.00	10.15	26.54	32.51	38.25	59.12	70.68	81.29	91.04	100.05	108.38	116.13	130.06	142.25	153.01	162.58	171.13	
					8.22	10.08	11.86	18.32	21.91	25.20	28.22	31.01	33.60	36.00	40.32	44.10	47.43	50.40	53.05	52
-	10.00	9.50	8.75	10.80	29.23	35.81	42.13	65.11	77.86	89.53	100.28	110.20	119.38	127.91	119.38	131.95	143.25	153.49	162.79	
					9.06	11.10	13.06	20.18	24.13	27.75	31.08	34.16	37.01	39.65	43.01	40.90	44.41	47.58	50.46	45
10.00	-	10.75	10.00	15.69	33.06	40.50	47.65	73.64	88.05	101.26	113.41	124.63	135.05	144.66	162.02	177.21	190.61	202.53	213.89	
					10.25	12.55	14.77	22.83	27.29	31.39	35.15	38.63	41.50	44.86	50.22	54.93	59.09	62.78	66.08	53
-	12.00	11.25	10.50	16.83	30.01	36.86	43.47	67.82	81.51	94.20	105.97	116.93	127.17	136.74	154.14	169.56	183.30	195.64	206.78	
					9.30	11.42	13.47	21.02	25.27	29.20	32.85	36.25	39.42	42.39	47.78	52.56	56.82	60.65	64.10	49
12.00	14.00	12.75	12.00	18.71 (PS) 21.91 (TS)	34.01	41.77	49.27	76.86	92.38	106.76	120.10	132.53	144.02	154.97	174.69	192.16	207.74	221.73	234.35	
					10.54	12.95	15.27	23.82	28.64	33.09	37.23	41.08	44.69	48.04	54.15	59.57	64.40	68.73	72.64	49
14.00	16.00	14.00	13.25	29.06 (PS)	30.59	37.70	44.60	70.37	85.13	98.96	111.95	124.18	135.72	146.61	166.67	184.72	201.06	215.91	229.47	
					9.48	11.69	13.82	21.81	26.39	30.68	34.70	38.49	42.07	45.45	51.67	57.26	62.33	66.93	71.13	43
16.00	18.00	16.00	15.00	32.51 (PS)	33.72	41.57	49.21	77.79	94.20	109.61	124.12	137.08	150.72	162.94	185.5	205.86	224.32	241.52	256.54	
					10.45	12.89	15.25	24.15	29.20	33.98	38.47	42.71	46.72	50.51	57.50	63.81	69.54	74.75	79.52	43
18.00	20.00	18.00	17.00	49.00	32.29	39.89	47.31	75.36	91.65	107.09	121.73	135.64	148.88	161.48	184.97	206.42	226.08	244.16	260.86	
					10.01	12.36	14.66	23.36	28.41	33.19	37.73	42.05	46.15	50.61	57.34	63.99	70.85	75.69	80.86	38
20.00	22.00	20.00	18.81	51.00	35.86	44.32	52.57	83.73	101.83	118.98	135.26	150.72	165.42	179.42	205.52	229.35	251.20	271.29	289.84	
					11.12	13.74	16.29	25.97	31.50	36.88	41.93	46.72	51.28	55.62	63.71	71.10	77.82	84.10	89.85	38
22.00	24.00	22.00	20.80	55.00	46.38	57.17	67.67	106.96	129.53	150.72	170.67	189.48	207.24	224.04	255.07	283.06	308.45	331.58	352.75	
					14.38	17.72	20.98	33.16	40.15	46.72	52.91	58.74	64.24	69.45	79.07	87.75	95.62	102.79	109.35	40.0
24.00	-	24.00	22.64	61.00	43.06	53.19	63.09	100.48	122.05	142.78	162.16	180.86	198.50	215.34	246.63	275.28	301.44	325.55	347.81	
					13.49	16.49	19.55	31.14	37.88	44.26	50.31	56.06	61.53	66.74	76.45	85.32	93.46	100.92	107.83	38

*Weight based on 10-slot construction (no fittings). (PS) = Pipe Size. (TS) = Telescope Size. NOTE: Flow data will vary based on strength requirements.

Screen Gauge Sizes used with Filter Material Sizes

Screen Gauge	Screen Opening (in.) (mm)	Filter Material Size (US Mesh)	Filter Material Size (in.)	Filter Material Size (mm)
100	0.100 2.54	3/4	0.250 - 0.187	6.350 - 4.750
30	0.032 .762	8/12	0.093 - 0.066	2.362 - 1.676
24	0.024 .609	10/20	0.079 - 0.0331	2.007 - 0.841
20	0.020 .508	12/20	0.066 - 0.0331	1.676 - 0.841
16	0.016 .406	16/30	0.047 - 0.023	1.194 - 0.585
12	0.012 .304	20/40	0.0331 - 0.0165	0.841 - 0.419
8	0.008 .203	40/60	0.0165 - 0.0098	0.419 - 0.249

NOTE: commonly used filter pack materials include gravel, sand, glass beads, ceramic beads, etc.

ALLOY SCREEN WORKS

▲▲▲ A division of Alloy Machine Works, Inc.

18102 East Hardy Road
Houston, Texas 77073 USA
Phone: 281.233.0214
Toll-free: 800.577.5068
Fax: 281.233.0487
Email: info@alloyscreenworks.com
www.alloyscreenworks.com

ISO 9001:2008 Registered QMS