

 KIRSCH®



ARCHITRAC®



PRACTICAL

# *Precision*

A perfect union of efficiency and performance, it's no wonder Architrac® can be found in such a variety of spaces. From homes, businesses and commercial applications, Architrac® offers multiple configurable styles to suit your needs and exceed your expectations. This performance focused product will glide through your most demanding applications with ease.

# OVERVIEW & BENEFITS

## Why Architrac®?

The Architrac® heading system supports the three most popular drapery heading styles, Ripplefold™, pleated and cubicle. Outstanding functionality for commercial applications, versatile enough for residential applications, Architrac® delivers performance for the most demanding applications. All assembled sets come complete and ready-to-install, and are available in baton and cord draw systems, or Series 94001 can be upgraded with Briza™ Motorization.

A perfect complement to the Architrac® series, our new K-Rail allows you to use any of our 1 3/8" finials from any of our collections, no matter the material or finish. You now have the ultimate power to customize your design since our K-Rail is designed in finishes that complement all of our collection finishes perfectly. You can finally bring your project to another level of customization.

## Benefits & Features

### Briza™ Motorization

- Easy to use
- Quiet, powerful motor
- Pleated or Ripplefold™ drapery heading styles
- Available on Architrac® Series 94001 or Estate™ Rods only
- For more information on Briza™ Motorization see page 6

### Ripplefold™

- Panels can be pressed flat, yet fall into folds
- Headings are suspended under the track
- No hooks or pins to install
- Stack back space is less than conventional Pleated draperies
- Draperies snap on and off carriers for easy installation
- Interior drapery appearance is identical to exterior-facing drapery appearance

### Pleated

- Can be used with most track systems using slip-in or pin-on hooks
- Headings can be suspended under the track or over the face of the track to conceal hardware
- A popular drapery heading style

### Cubicle

- An excellent choice for where privacy is necessary; often found in healthcare facilities, this heading style can be used more creatively as a soft treatment room divider or a unique shower curtain rod
- Smooth, snag free operation
- Made of extruded aluminum for extra durability
- Inner surface is center grooved for easy installation

## Architrac® at a Glance

To help determine which system is right for your project, use the guideline below to select the best fit.

ARCHITRAC® SERIES	94001 BEST SELLER	93001	94003	94004 BEST SELLER	94005	9046	9600	K-RAIL NEW
<b>What is your preferred Draw type?</b>								
Cord Draw	•	•						
Hand   Baton Draw	•	•	•	•	•	•	•	•
Briza™ Motorized   <b>NEW</b>	•							
<b>What is the preferred Drapery Heading type?</b>								
Pleated	•	•	•	•	•	•	•	•
Cubicle			•	•	•	•	•	•
Ripplefold™	•	•	•	•	•			•
<b>What is your mounting location?</b>								
Ceiling Mount	•	•	•	•	•	•	•	•
Wall Mount	•	•	•				•	•
Recessed Mount	•	•	•	•	•	•	•	
Suspension Mount						•	•	
<b>Is an Angular Bend or Curve needed?</b>								
Can be bent*	•	•	•		•	•	•	
Can be curved*	•	•	•		•	•	•	
<b>What is the Track Length?</b>								
One-Way Draw   Max Track Length	UP TO 20'	UP TO 16'	UP TO 20'	UP TO 16'	UP TO 16'	UP TO 16'	UP TO 20'	UP TO 16'
Two-Way Draw   Max Track Length	UP TO 40'	UP TO 32'	UP TO 20'	UP TO 32'	UP TO 32'	UP TO 32'	UP TO 40'	UP TO 16'
<b>What are the Fabric Weight requirements?</b> (Weight shown is pounds per linear foot)								
One-Way with Cord, Hand/Baton	4 LBS	2 LBS	4 LBS	4 LBS	4 LBS	4 LBS	4 LBS	4 LBS
Two-Way with Cord, Hand/Baton	4 LBS	2 LBS	4 LBS	4 LBS	4 LBS	4 LBS	4 LBS	4 LBS
One-Way with Briza™	6.25 LBS	N/A	N/A	N/A	N/A	N/A	N/A	N/A
Two-Way with Briza™	2.5 LBS	N/A	N/A	N/A	N/A	N/A	N/A	N/A

\* Architrac Series 94001 with Briza™ Motorization cannot be bent or curved.

# ARCHITRAC®

## Series 94001 | Multi-Draw System

- **NEW** | Briza™ Motorization available
- Assembled sets includes all necessary components
- Most versatile Architrac® Rod
- Heavy duty, ball bearing pulleys
- Heavy duty, wheeled (Ripplefold™) or ball bearing (pleated) carriers
- Can be curved or bent (not available for Briza™ Motorized tracks)
- Wall or ceiling mount available
- Multiple draw options available; cord, baton/hand or Briza™ Motorization

### Available Draw Types

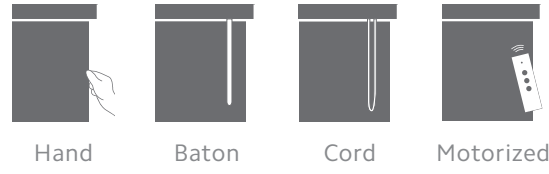

### Available Colors

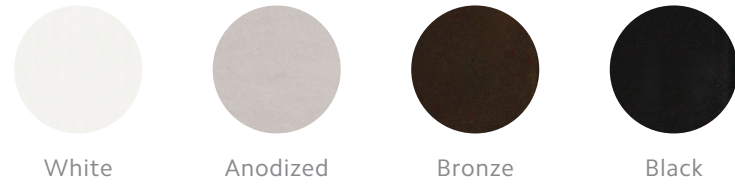

### Additional Information

For more detailed information about this track, please visit our resource library at [kirsch.com](http://kirsch.com).

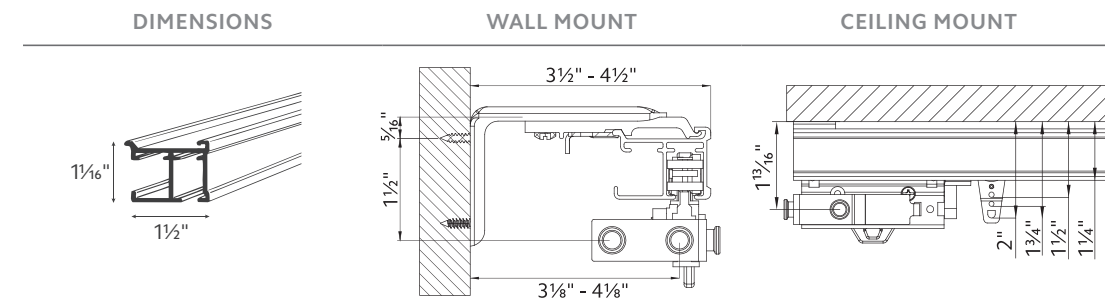

DRAW	MOUNT	MAXIMUM TRACK SET	MAXIMUM FABRIC WEIGHT	LBS. PER FOOT		
ONE-WAY	CEILING   WALL   RECESSED	20'	Cord, Hand/Baton	80	Cord, Hand/Baton	4
			Briza™	100	Briza™	6.25
TWO-WAY	CEILING   WALL   RECESSED	40'	Cord, Hand/Baton	160	Cord, Hand/Baton	4
			Briza™	100	Briza™	2.5

Max track lengths and maximum fabric weights do not apply to curved tracks.  
Send complete specifications and fabric weight to customer service for feasibility.

**AVAILABLE BENDS** \* Architrac Series 94001 with Briza™ Motorization cannot be bent or curved.



# BRIZA™ MOTORIZATION







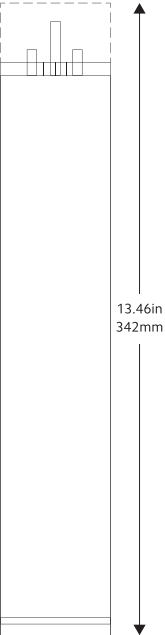
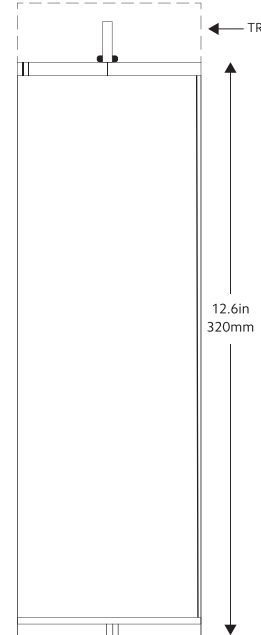
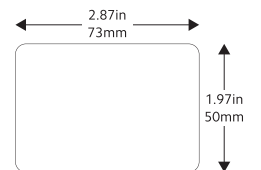

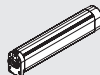

## Motorization System

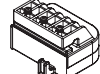
- Soft start/stop & manual operation
- Tug feature; when drapery is pulled the motor will traverse the drapery
- Automatic limits on end stop
- Favorite/intermediate position available
- Dry contact for external control
- Radio technology
- Setting with buttons on motor unit
- Setting with external dry contact switch
- LED Indicators
- One-Way and Two-Way Draw
- Pleated
- Ripplefold™ with overlap master
- Ripplefold™ with butt master (not available on one-way draw)

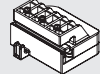
## Additional Information

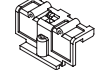
SIDE VIEW	FRONT VIEW	BOTTOM VIEW	MOTORIZED TRACK FEATURES	BRIZA™ MOUNT
			Power Supply	24 VDC (AC adapter for 110-24v)
			Amperage	1500 mA
			Average Linear Speed	7.8 inches/sec
			Power Consumption	40 watts
			Torque	1.2Nm
			Power Cable Length	9 feet
			Certifications	CE
			Max Track Length	Estate™ – 16ft Architrac® 94001 – 40ft
			Max. Load	100 lbs

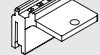
## Component Overview

ITEM	PRODUCT NUMBER & FINISH	DESCRIPTION	ITEM	PRODUCT NUMBER & FINISH	DESCRIPTION
	84500025 White	Draper Motor BTE DC 24v		84505025 White	Draper Motor Belt Connector Back
	84501025 White 84501059 Black 84501061 Grey 84501064 Bronze	Draper Motor Head Adapter Right Hand		84506025 White	Draper Motor Belt Connector Clip
	84502025 White 84502059 Black 84502061 Grey 84502064 Bronze	Draper Motor Head Adapter Left Hand		84510000	Motor Belt
	84503025 White 84503059 Black	Draper Motor Master Carrier Adapter		84511025 White	Remote Control 4 Channels
	84504025 White	Draper Motor Belt Connector Front		84512025 White	DC Adapter 24v

\* Briza™ Motorization is available on Architrac® Series 94001 and Estate™ Rods only.



# ARCHITRAC®

## Series 93001 | Cord Draw System

- Assembled set includes all necessary components
- Low profile track (5/8")
- Self lubricating end pulleys
- Front loading carriers (pleated) for easy installation
- Can be curved or bend
- Wall or ceiling mount available

### Available Draw Types



Hand Baton Cord

### Available Colors



White

### Additional Information

For more detailed information about this track, please visit our resource library at [kirsch.com](http://kirsch.com).

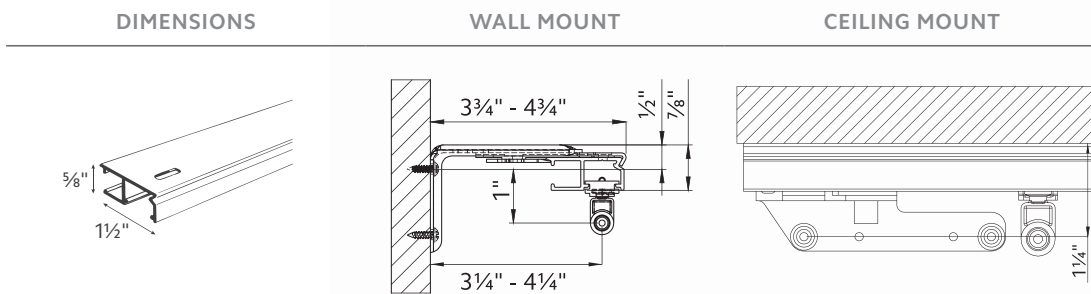

DRAW	MOUNT	MAXIMUM TRACK SET	MAXIMUM FABRIC WEIGHT	LBS. PER FOOT
ONE-WAY	CEILING   WALL   RECESSED	16'	32 LBS.	2 LBS.
TWO-WAY	CEILING   WALL   RECESSED	32'	64 LBS.	2 LBS.

Max track lengths and maximum fabric weights do not apply to curved tracks.  
Send complete specifications and fabric weight to customer service for feasibility.

### AVAILABLE BENDS

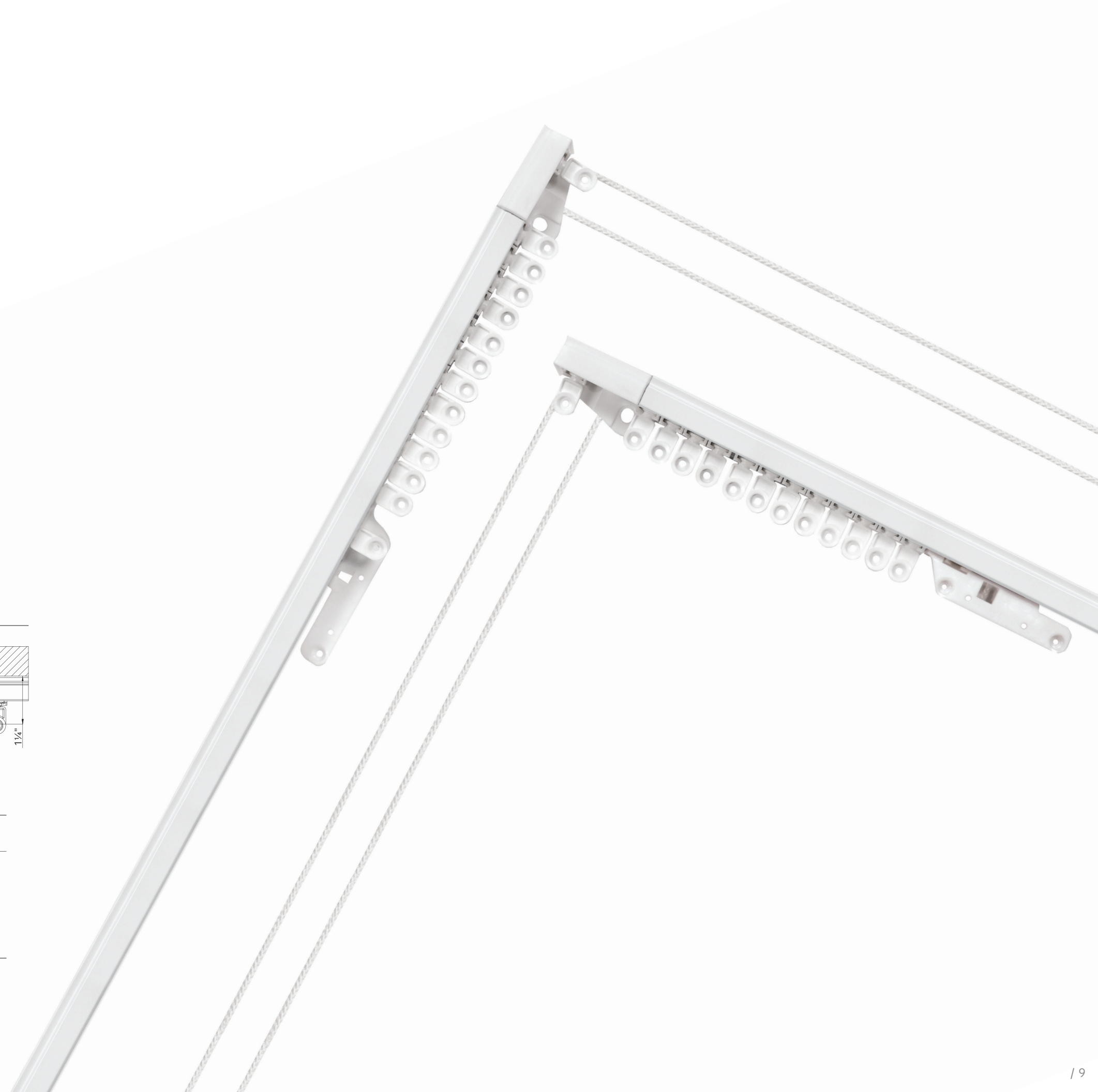

# ARCHITRAC®

## Series 94003 | Baton Draw System

- Assembled sets includes all necessary components
- Most versatile baton draw track
- Heavy duty, wheeled (Ripplefold™) or ball bearing (pleated) carriers
- Can be curved or bent
- Wall or ceiling mount available
- Baton options available

### Available Draw Types

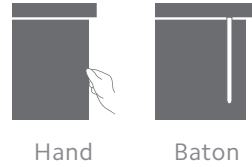

Hand Baton

### Available Colors

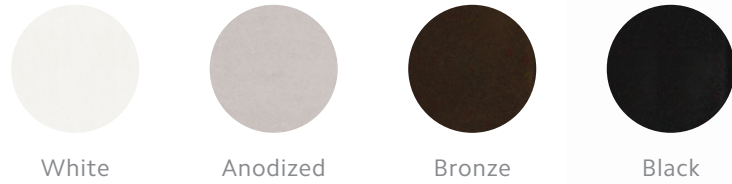

White Anodized Bronze Black

### Additional Information

For more detailed information about this track, please visit our resource library at [kirsch.com](http://kirsch.com).

#### DIMENSIONS

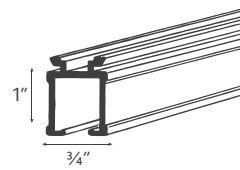

#### WALL MOUNT

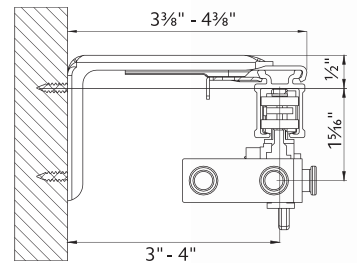

#### CEILING MOUNT

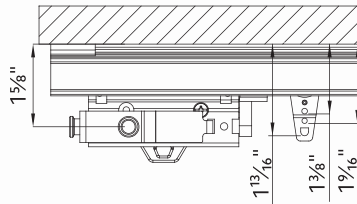

DRAW	MOUNT	MAXIMUM TRACK SET	MAXIMUM FABRIC WEIGHT	LBS. PER FOOT
ONE-WAY	CEILING   WALL   RECESSED	20'	80 LBS.	4 LBS.
TWO-WAY	CEILING   WALL   RECESSED	40'	160 LBS.	4 LBS.

Max track lengths and maximum fabric weights do not apply to curved tracks.  
Send complete specifications and fabric weight to customer service for feasibility.

#### AVAILABLE BENDS



# ARCHITRAC®

## Series 94004 | Baton Draw System

- Assembled sets includes all necessary components
- Low profile, baton draw rod (3/4")
- Heavy duty, wheeled (Ripplefold™) or ball bearing (pleated) carriers
- Cannot be curved or bent
- Ceiling mount only (Track pre-drilled 16" on center for direct ceiling mount)
- Baton options available

### Available Draw Types



Hand



Baton

### Available Colors



White



Anodized

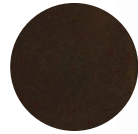

Bronze



Black

### Additional Information

For more detailed information about this track, please visit our resource library at [kirsch.com](http://kirsch.com).

#### DIMENSIONS

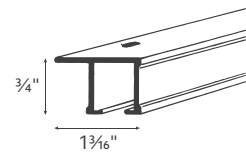

#### CEILING MOUNT

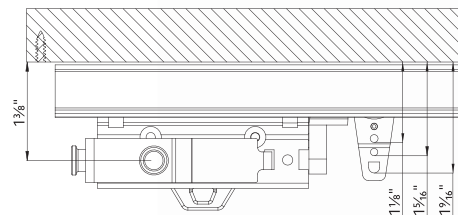

DRAW	MOUNT	MAXIMUM TRACK SET	MAXIMUM FABRIC WEIGHT	LBS. PER FOOT
ONE-WAY	CEILING   RECESSED	16'	64 LBS.	4 LBS.
TWO-WAY	CEILING   RECESSED	32'	128 LBS.	4LBS.



# ARCHITRAC®

## Series 94005 | Baton Draw System

- Assembled sets includes all necessary components
- Heavy duty, wheeled (Ripplefold™) or ball bearing (pleated) carriers
- Can be curved or bent
- Ceiling mount only (Track pre-drilled 16" on center for direct ceiling mount)
- Baton options available

### Available Draw Types

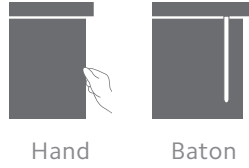

Hand Baton

### Available Colors

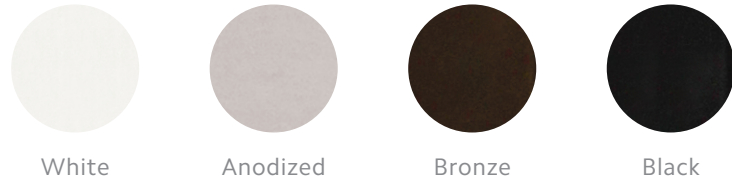

White Anodized Bronze Black

### Additional Information

For more detailed information about this track, please visit our resource library at [kirsch.com](http://kirsch.com).

#### DIMENSIONS

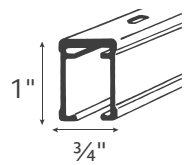

#### CEILING MOUNT

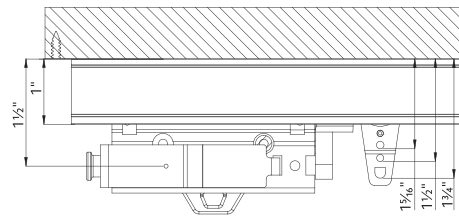

DRAW	MOUNT	MAXIMUM TRACK SET	MAXIMUM FABRIC WEIGHT	LBS. PER FOOT
ONE-WAY	CEILING   RECESSED	16'	64 LBS.	4 LBS.
TWO-WAY	CEILING   RECESSED	32'	128 LBS.	4 LBS.

Max track lengths and maximum fabric weights do not apply to curved tracks. Send complete specifications and fabric weight to customer service for feasibility.

#### AVAILABLE BENDS

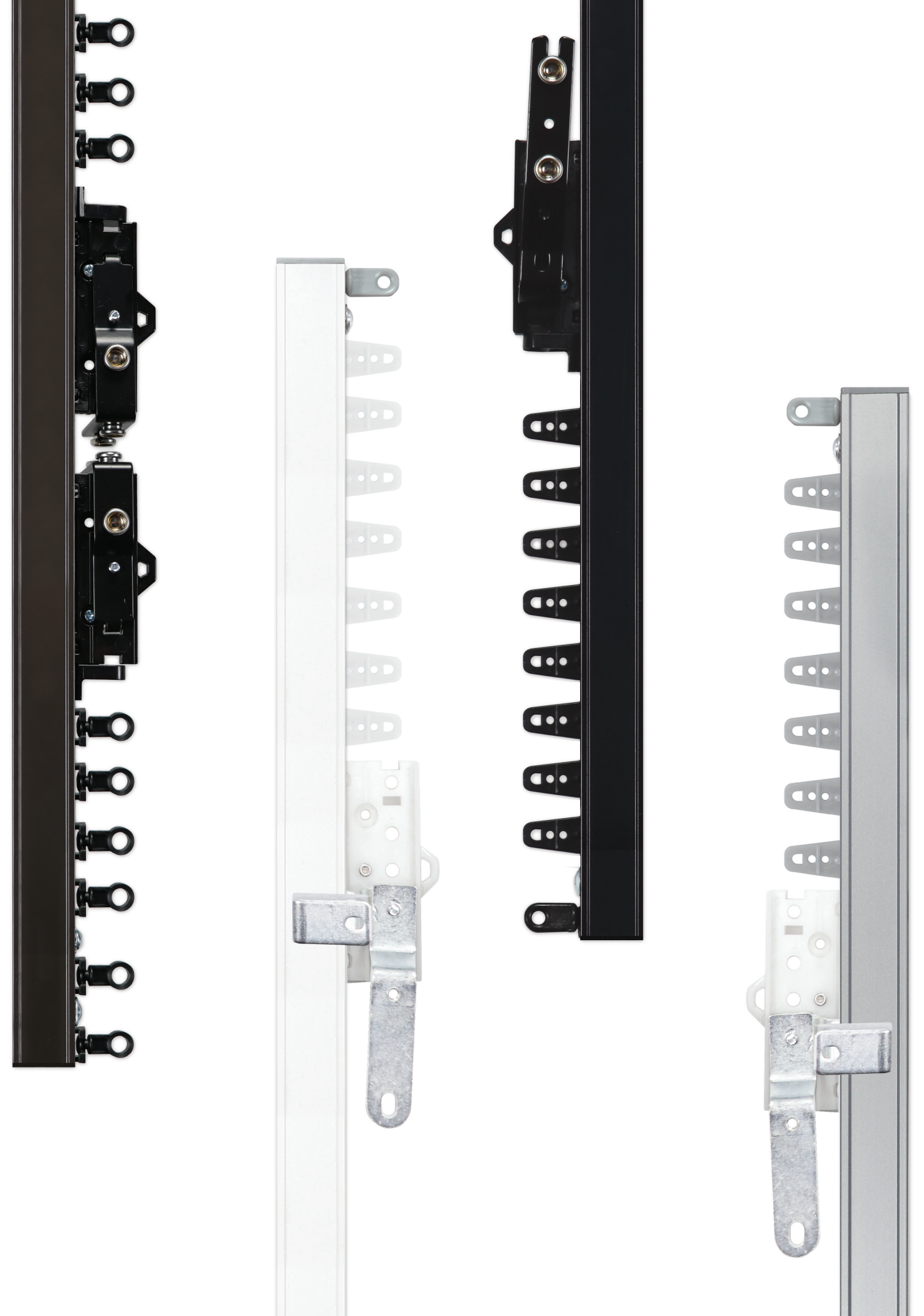

# ARCHITRAC®

## Series 9046 | Cubicle System

- Assembled sets includes all necessary components
- Low profile, cubicle track (1/2")
- Ideal for cubicle curtains for commercial applications
- Can be curved or bent
- Baton options available
- Pleated or cubicle carriers

### Available Draw Types

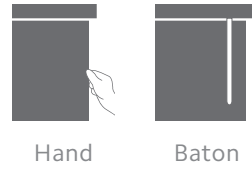

Hand Baton

### Available Colors

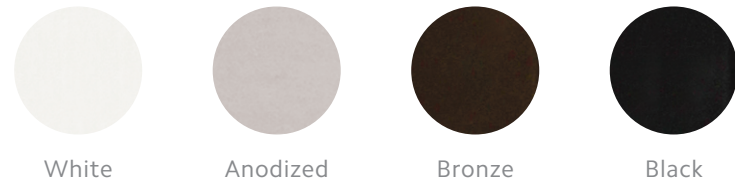

White Anodized Bronze Black

### Additional Information

For more detailed information about this track, please visit our resource library at [kirsch.com](http://kirsch.com).

#### DIMENSIONS

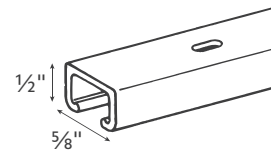

#### CEILING MOUNT

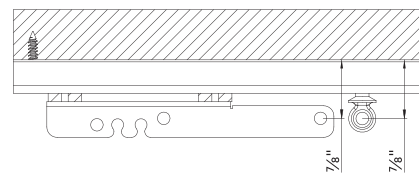

DRAW	MOUNT	MAXIMUM TRACK SET	MAXIMUM FABRIC WEIGHT	LBS. PER FOOT
ONE-WAY	CEILING   RECESSED   SUSPENSION	16'	64 LBS.	4 LBS.
TWO-WAY	CEILING   RECESSED   SUSPENSION	32'	128 LBS.	4 LBS.

Max track lengths and maximum fabric weights do not apply to curved tracks. Send complete specifications and fabric weight to customer service for feasibility.

#### AVAILABLE BENDS

Cubicle Style 1: L-Shaped	Cubicle Style 2: Long-U	Cubicle Style 3: J-Track	Cubicle Style 4: J-Track Offset Right	Cubicle Style 5: J-Track Offset Left
Cubicle Style 1: Obtuse J-Track Right	Cubicle Style 2: Obtuse J-Track Left	Cubicle Style 3: Straight Offset Right	Cubicle Style 4: Straight Offset Left	Cubicle Style 5: Curved



# ARCHITRAC®

## Series 9600 | Cubicle System

- Assembled sets includes all necessary components
- Heavy duty, cubicle track
- Ideal for cubicle curtains for commercial applications
- Splice available
- Carriers for pleated or cubicle options available
- Wall, ceiling or suspension mount available
- Can be curved or bent

### Available Draw Types



Hand Baton

### Available Colors



White Anodized Bronze Black

### Additional Information

For more detailed information about this track, please visit our resource library at [kirsch.com](http://kirsch.com).

DIMENSIONS		WALL MOUNT (using 81003xxx bracket)	CEILING MOUNT		
DRAW	MOUNT	MAXIMUM TRACK SET	MAXIMUM FABRIC WEIGHT	LBS. PER FOOT	
ONE-WAY	CEILING   WALL   RECESSED   SUSPENSION	20'	80 LBS.	4 LBS.	
TWO-WAY	CEILING   WALL   RECESSED   SUSPENSION	40'	160 LBS.	4 LBS.	

Max track lengths and maximum fabric weights do not apply to curved tracks.  
Send complete specifications and fabric weight to customer service for feasibility.

### AVAILABLE BENDS

Cubicle Style 1: L-Shaped 	Cubicle Style 2: Long-U 	Cubicle Style 3: J-Track 	Cubicle Style 4: J-Track Offset Right 	Cubicle Style 5: J-Track Offset Left 
Cubicle Style 1: Obtuse J-Track Right 	Cubicle Style 2: Obtuse J-Track Left 	Cubicle Style 3: Straight Offset Right 	Cubicle Style 4: Straight Offset Left 	Cubicle Style 5: Curved 



# K-RAIL

## K-Rail | 1 3/8" Decorative System

- Assembled set includes all necessary components
- Versatile baton draw track adds a decorative element allowing for color coordination
- Compatible with every 1 3/8" finial
- Color coordinated to match with any finish
- Heavy duty, wheeled Ripplefold™ or ball bearing pleated carriers
- Wall or ceiling mount available
- Baton options available

### Available Draw Types



Hand Baton

### Available Colors



White Anodized Bronze Black

### Additional Information

For more detailed information about this track, please visit our resource library at [kirsch.com](http://kirsch.com).



#### DIMENSIONS

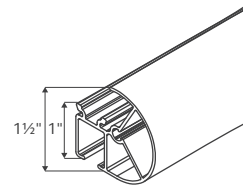

#### WALL MOUNT

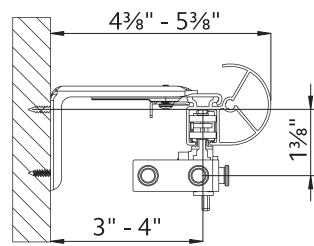

#### CEILING MOUNT

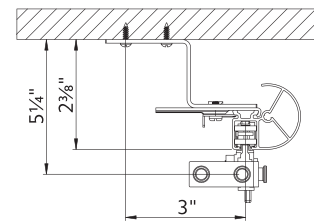

DRAW	MOUNT	MAXIMUM TRACK SET	MAXIMUM FABRIC WEIGHT	LBS. PER FOOT
ONE-WAY	CEILING   WALL	16'	64 LBS.	4 LBS.
TWO-WAY	CEILING   WALL	16'	64 LBS.	4 LBS.

 KIRSCH®

BUCKINGHAM®  
redefining luxury

DESIGNER METALS™  
inspiring brilliance

WOOD TRENDS™  
renewing traditions

WROUGHT IRON  
forging artistry

RENAISSANCE™  
awakening perfection

ARCHITRAC®  
practical precision

ESTATE™  
innovating comfort