

ABRASIVE PRODUCTS

GRINDING WHEELS

Reinforced Wheels Depressed Center

FOR USE ON RIGHT
ANGLE GRINDERS



- Aluminum oxide abrasive with a resin bond reinforced by layers of durable fabric to provide wheels of maximum strength and safety.
- **Fast cutting** flexible, extremely durable, and economical.

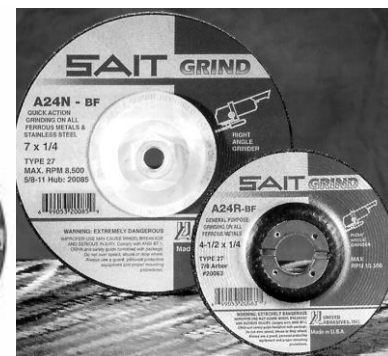

| J&B # | MFG # | SIZE | ARBOR | MATERIAL | MAX RPM | QTY | CASE |
|----------|--------|-------------|------------|----------|---------|-----|------|
| ~ 39061 | 20015 | 4 x 1/4 | 5/8 hole | A24N | 13,500 | EA | 25 |
| ~ 38864 | 20163 | 4-1/2 x 1/4 | 5/8-11 nut | A24R | 13,300 | EA | 10 |
| * 49115 | A1226H | 4-1/2 x 1/4 | 5/8-11 nut | A24/30T | 13,300 | EA | 10 |
| * V41990 | A1203H | 4-1/2 x 1/4 | 5/8-11 nut | A24ALU | 13,300 | EA | 10 |
| * 38865 | A1236 | 4-1/2 x 1/4 | 7/8 hole | A24T | 13,300 | EA | 25 |
| * V41991 | A1203 | 4-1/2 x 1/4 | 7/8 hole | A24ALU | 13,300 | EA | 25 |
| ~ 38866 | 20070 | 5 x 1/4 | 7/8 hole | A24N | 12,200 | EA | 25 |
| * V20097 | A3236 | 6 x 1/4 | 7/8 hole | A30N | 10,000 | EA | 25 |
| ~ 20098 | 20086 | 7 x 1/4 | 5/8-11 nut | A24R | 8,500 | EA | 10 |
| ~ 20146 | 20195 | 9 x 1/4 | 5/8-11 nut | A24T | 6,600 | EA | 10 |

* = Flexovit Brand ~ = Sait Brand

GENERAL PURPOSE - METAL - FAST CUT (A24N):

- Aggressive grinding with excellent life.
- Grinds aggressively in a wide range of metal applications, including harder materials.
- Aluminum oxide grain. Soft bond for fast stock removal.

HIGH PERFORMANCE - METAL - LONG LIFE (A24R):

- Smooth grinding with maximum life for an aluminum oxide wheel.
- Weld grinding, surface conditioning, notching, cutting, and all general purpose stock removal.
- The standard for long life in metal work.

EDGE GRINDING - METAL - LONG LIFE (A24T):

- Aluminum oxide grain.
- Hard bond designed for edge & bevel grinding & other applications where a harder wheel is preferred.
- Ferrous metals (iron, steel, welds, etc.)

ALUMINUM - LOAD RESISTANT - (A24ALU)

- Ideal for grinding aluminum and nonferrous materials.

ABRASIVE PRODUCTS

METALHOG GRINDING WHEEL

Reinforced Wheels Depressed Center

**** Superior Productivity ** Higher Efficiency ** Longer Life**

FOR USE ON RIGHT ANGLE GRINDERS



- Type 27 grinding wheels incorporate a blend of premium, semi-premium & standard abrasive grain with custom bond systems.
- Extremely aggressive & rapid grinding action without sacrificing wheel life.
- METALHOG grinds up to 30% faster & 3 times Longer than regular aluminum oxide products.



| J&B # | MFG # | SIZE | ARBOR | MATERIAL | MAX RPM | QTY | CASE |
|-------|-------|-------------|----------|----------|---------|-----|------|
| 41908 | A1230 | 4-1/2 x 1/4 | 7/8 hole | AXT24S | 13,300 | EA | 25 |

RAPID GRIND – METAL, STAINLESS - FAST CUT/LONG LIFE (AXT24S):

- Fast, aggressive stock removal.

E.T. ERGONOMIC TECHNOLOGY

Flexovit

FOR USE ON ANGLE GRINDERS



- New saucer shaped grinding wheel incorporating ergonomic technology. Allows **more contact area** between the wheel & the workpiece, resulting in more controlled grinding & blending without gouging & with **less pressure required**.
- Intended for flat surfaces & rugged edge grinding.
- Designed to fit under standard angle grinder guards.
- Built with 3 full layers of high tensile fiberglass reinforcement for maximum workplace safety.



| J&B # | MFG # | SIZE | SPEC | MAX RPM | QTY | CASE |
|-------|-------|-------------------|------|---------|-----|------|
| 49100 | A1237 | 4-1/2 x 1/4 x 7/8 | A30S | 13,300 | EA | 25 |

ABRASIVE PRODUCTS

CHALLENGER II GRINDING WHEELS

Semi-Flexible Wheels
ALUMINUM / STAINLESS / METAL

FOR USE ON RIGHT ANGLE GRINDERS

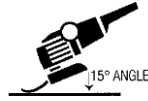

MUST BE USED AT A
MINIMUM 15° ANGLE
- DO NOT USE FLAT -



- Eliminate wheel-change downtime by grinding and finishing with the same wheel.
- **Challenger II** performs well in all metal fabrication applications.
- **Challenger II** runs virtually LOAD-FREE.
- **Challenger II** tackles stainless and hard alloy applications without glazing or dulling.
- Great for Metal, Stainless, or Aluminum.

| J&B # | MFG # | SIZE | TYPE | ARBOR | GRIT | MAX RPM | QTY |
|--------|-------|-------------|------|----------|------|---------|-----|
| *42200 | 27501 | 4-1/2 x 1/8 | 29 | 7/8 hole | 60 | 13,280 | EA |

25 in a case

* Use backing pad part # 95245 from United Abrasives.



Type 29

ABRASIVE PRODUCTS

ZIRCOTEX PREMIUM FLAP DISCS

Fiberglass Backing Plate

FOR USE ON ANGLE GRINDERS



- Made with premium zirconia alumina abrasive cloth backed by a high strength fiberglass disc.
- Ideal for high production grinding, blending, deburring and finishing.
- Perform well on a wide variety of materials including stainless & carbon steel.
- Durable grain resists loading or clogging on softer materials such as aluminum, brass, bronze & fiberglass.
- The fanned, abrasive cloth flaps wear evenly, constantly exposing new, sharp grain allowing for full use of the disc



| J&B # | MFG # | SIZE | GRIT | TYPE | MAX RPM | QTY | CASE |
|-------|---------|----------------|------|------|---------|-----|------|
| 45401 | Z4501FH | 4-1/2 x 5/8-11 | 24 | 29 | 13,300 | EA | 10 |
| 45402 | Z4500FH | 4-1/2 x 5/8-11 | 40 | 29 | 13,300 | EA | 10 |
| 45416 | Z4505FH | 4-1/2 x 5/8-11 | 60 | 29 | 13,300 | EA | 10 |
| 45500 | Z4510FH | 4-1/2 x 5/8-11 | 80 | 29 | 13,300 | EA | 10 |
| 45422 | Z4525F | 4-1/2 x 7/8 | 24 | 27 | 13,300 | EA | 10 |
| 45406 | Z4530F | 4-1/2 x 7/8 | 40 | 27 | 13,300 | EA | 10 |
| 45398 | Z4535F | 4-1/2 x 7/8 | 60 | 27 | 13,300 | EA | 10 |
| 45408 | Z4540F | 4-1/2 x 7/8 | 80 | 27 | 13,300 | EA | 10 |
| 47005 | Z4545F | 4-1/2 x 7/8 | 120 | 27 | 13,300 | EA | 10 |
| 45412 | Z4500F | 4-1/2 x 7/8 | 40 | 29 | 13,300 | EA | 10 |
| 45409 | Z4505F | 4-1/2 x 7/8 | 60 | 29 | 13,300 | EA | 10 |
| 45420 | Z4510F | 4-1/2 x 7/8 | 80 | 29 | 13,300 | EA | 10 |

SAIT ENCORE FLAP DISC

Fiberglass Backing Plate

- Heavy duty for long-life and high stock removal.
- Use on carbon and stainless steel, made with premium zirconium abrasive material which provides long-life & high stock removal.



| J&B # | MFG # | SIZE | GRIT | TYPE | MAX RPM | QTY | CASE |
|-------|-------|-------------|------|------|---------|-----|------|
| 45399 | 71205 | 4-1/2 x 7/8 | 36 | 27 | 13,300 | EA | 10 |
| 45400 | 71206 | 4-1/2 x 7/8 | 40 | 27 | 13,300 | EA | 10 |
| 49102 | 71208 | 4-1/2 x 7/8 | 60 | 27 | 13,000 | EA | 10 |

ABRASIVE PRODUCTS

TORNADO FLAP DISC

Nylon Backing

FOR USE ON ANGLE GRINDERS



- Nylon backing for easy, burn-free trimming.
- Safe & durable, vented for air cooling.
- Integrated, no strip thread –ready for mounting, no flange adaptor required.
- Premium zirconia cloth for high productivity.
- High performance & long life, resists loading & glazing.



Type 29

| J&B # | MFG # | SIZE | GRIT | TYPE | MAX RPM | QTY | CASE |
|-------|---------|----------------|------|------|---------|-----|------|
| 42201 | Z4500NT | 4-1/2 x 5/8-11 | 40 | 29 | 13,300 | EA | 10 |
| 42202 | Z4505NT | 4-1/2 x 5/8-11 | 60 | 29 | 13,300 | EA | 10 |
| 42203 | Z4510NT | 4-1/2 x 5/8-11 | 80 | 29 | 13,300 | EA | 10 |
| 42204 | Z4520NT | 4-1/2 x 5/8-11 | 120 | 29 | 13,300 | EA | 10 |

OVATION FLAP DISCS

Fiberglass Backing Plate

FOR USE ON ANGLE GRINDERS



- High pressure is ideal for removing deeper scratches from the work surface.
- Heavy duty / long life for tough applications.
- Premium zirconium grain on a tough, full polyester backing.
- Will not contaminate stainless steel.

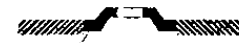

Type 27

| J&B # | MFG # | SIZE | GRIT | TYPE | MAX RPM | QTY | CASE |
|-------|-------|---------|------|------|---------|-----|------|
| 59125 | 78036 | 6 x 7/8 | 40 | 27 | 10,200 | EA | 10 |

ABRASIVE PRODUCTS

OVATION ATTACKER PLUS

Plastic Backing

FOR USE ON ANGLE GRINDERS



- High performance zirconium grain for a wide variety of grinding and finishing applications.
- Provides long life while maintaining high stock removal rates.
- 40% more material than conventional, regular density flap discs.
- For Stainless steel, high tensile steel, titanium, ferrous metals, non-ferrous metals (aluminum, copper, brass, etc).



Type 27

| J&B # | MFG # | SIZE | GRIT | TYPE | MAX RPM | QTY | CASE |
|--------|-------|-------------|------|------|---------|-----|------|
| V21515 | 72216 | 4-1/2 x 7/8 | 60 | 27 | 13,300 | EA | 10 |
| V21522 | 72217 | 4-1/2 x 7/8 | 80 | 27 | 13,300 | EA | 10 |

OVATION CERAMIC PLUS

Plastic Backing

FOR USE ON ANGLE GRINDERS



- Premium ceramic grain outlasts conventional zirconium in most applications.
- Cooler cutting and fast, consistent finishes.
- 40% more material than conventional, regular density flap discs.
- For ferrous and/or non-ferrous metals, stainless steel and high tensile steel, titanium.



Type 27

| J&B # | MFG # | SIZE | GRIT | TYPE | MAX RPM | QTY | CASE |
|--------|-------|-------------|------|------|---------|-----|------|
| V21500 | 72228 | 4-1/2 x 7/8 | 60 | 27 | 13,300 | EA | 10 |

ABRASIVE PRODUCTS

OVATION CERAMIC

FOR USE ON ANGLE GRINDERS



- Premium ceramic grain outlasts conventional Zirconium in most applications.
- Cooler cutting and fast consistent finishes.
- 40% more material than conventional, regular density flap discs.
- For Stainless steel, high tensile steel, titanium, ferrous metals, non-ferrous metals (aluminum, copper, brass, etc).



Type 27

| J&B # | MFG # | SIZE | GRIT | TYPE | MAX RPM | QTY |
|--------|-------|-------------|------|------|---------|-----|
| V41424 | 78261 | 4-1/2 x 7/8 | 40 | 27 | 13,300 | EA |

CASE
10

ABRASIVE PRODUCTS

GRINDING WHEELS

FOR USE ON BENCH & PEDESTAL MACHINES



- ALUMINUM OXIDE for metal grinding carbon, stainless or alloys.
- Runs cool for long grinding life; maintains shape.
- May be used for general purpose grinding or finishing and sharpening.

| J&B # | MFG # | SIZE | ARBOR | NESTED BUSHINGS | STYLE | GRIT | MAX RPM | QTY |
|-------|-------|-------|-------|------------------|--------|------|---------|-----|
| 39030 | U4730 | 6 x 1 | 1 | 1/2, 5/8, 3/4 | MED/FN | A60 | 4,138 | EA |
| 38460 | U4710 | 6 x 1 | 1 | 1/2, 5/8, 3/4 | COARSE | A24 | 4,138 | EA |
| 39032 | U5130 | 8 x 1 | 1-1/4 | 1/2, 5/8, 3/4, 1 | MED/FN | A60 | 3,600 | EA |
| 38462 | U5110 | 8 x 1 | 1-1/4 | 1/2, 5/8, 3/4, 1 | COARSE | A24 | 3,600 | EA |

BENCH WHEEL DRESSER

- Designed to true bench wheels to correct shape.
- Quickly remove foreign material embedded in the face of the wheel.

| J&B # | DIAMETER | THICKNESS | QTY |
|-------|--------------------|-----------|-----|
| 39127 | Up to 10" | Up to 2" | EA |
| 39128 | Replacement Cutter | | EA |

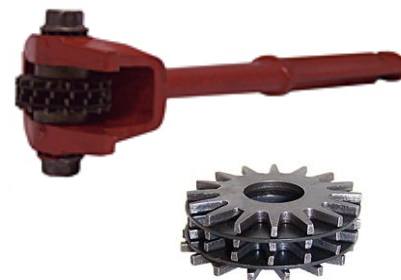

RESIN FIBER ABRASIVE DISCS

Closed Coat

FOR USE ON RIGHT ANGLE GRINDERS



- Closed coat structure for more material removal & better finishing.
- Use for grinding mild steel or stainless, weld preparation, or blending and finishing.



| J&B # | MFG # | SIZE | GRIT | QTY |
|--------|-------|-------------|------|-----|
| 41410 | 32218 | 4-1/2 x 7/8 | 50 | 25 |
| 41412 | 32220 | 4-1/2 x 7/8 | 80 | 25 |
| *38963 | 32231 | 5 x 7/8 | 24 | 25 |
| 41416 | 32232 | 5 x 7/8 | 36 | 25 |
| 41418 | 32234 | 5 x 7/8 | 60 | 25 |
| 41419 | 32235 | 5 x 7/8 | 80 | 25 |
| 41421 | 32237 | 5 x 7/8 | 120 | 25 |

| J&B # | MFG # | SIZE | GRIT | QTY |
|--------|--------|---------|------|-----|
| *38965 | 32246 | 7 x 7/8 | 24 | 25 |
| *38967 | S4010G | 9 x 7/8 | 24 | 25 |
| ^43426 | 66906 | 9 x 7/8 | 36 | 25 |

* These items are sold in box quantities only.
 ^ 43426 is 3M brand

ABRASIVE PRODUCTS

RESIN FIBER ABRASIVE DISCS

Open Coat

FOR USE ON RIGHT ANGLE GRINDERS



- Open coat structure prevents loading with fast material removal
- Use on ferrous and/or non-ferrous metals, wood and fiberglass.
- Discs come on handy dispenser to prevent bowing.

| J&B # | MFG # | SIZE | GRIT | QTY |
|--------|-------|-------------|------|-----|
| 46439 | 52480 | 4-1/2 x 7/8 | 80 | 100 |
| 46438 | 52460 | 4-1/2 x 7/8 | 60 | 100 |
| 46437 | 52450 | 4-1/2 x 7/8 | 50 | 100 |
| 46436 | 52436 | 4-1/2 x 7/8 | 36 | 100 |
| *46445 | 69226 | 4-1/2 x 7/8 | 36 | 100 |
| 46430 | 52750 | 7 x 7/8 | 50 | 100 |
| 46036 | 52736 | 7 x 7/8 | 36 | 100 |
| 46429 | 52724 | 7 x 7/8 | 24 | 50 |
| 46440 | 52716 | 7 x 7/8 | 16 | 100 |

- Cannot break box quantities -

* Part# 46445 is a closed coat zirconia alumina abrasive material on an X-weight, water resistant polyester/cotton blended backing. For general purpose grinding and finishing on ferrous and non-ferrous metals, cast iron, aluminum, stainless steel and wood materials.

SPIRALCOOL BACKING PAD

- Spiralcool backing pads exclusive rubber, fabric and fiber board construction provide extra strength and reliability.
- Spiral ribs provide contact points and form channels for air flow extending disc life 30% to 50%.



| J&B # | MFG # | SIZE | ARBOR | GRADE | MAX RPM | QTY |
|-------|-------|--------|--------|--------|---------|-----|
| 41959 | 95011 | 4-1/2" | 5/8 | HARD | 11,000 | EA |
| 41983 | 95016 | 5" | 5/8 | MEDIUM | 10,000 | EA |
| 41972 | 95018 | 7" | 5/8-11 | MEDIUM | 8,500 | EA |

ABRASIVE PRODUCTS

ULTIMATE CUT CUT-OFF WHEELS

FOR USE ON RIGHT ANGLE GRINDERS



- Best in class – cutting a wide range of stainless thin & thick gauge, flat stock, bar stock, square tubing, etc.
- Exceptional cutting performance on metal & aluminum.
- Maximizes productivity.

| J&B # | MFG # | SIZE | | | TYPE | MAX RPM | QTY |
|-------|-------|-------|------|-------|------|---------|-----|
| | | DIA | THK | ARBOR | | | |
| 49106 | 23152 | 3 | .035 | 1/4 | 1 | 25,000 | 10 |
| 38464 | 22230 | 4-1/2 | .045 | 7/8 | 1 | 13,300 | 10 |
| 38466 | 22240 | 6 | .045 | 7/8 | 1 | 10,200 | 10 |

NOTE: CUT-OFF WHEELS ARE FOR USE ON RIGHT ANGLE GRINDERS EQUIPPED WITH PROPER TYPE 1 FLANGES. DO NOT USE WITH TYPE 27 STYLE FLANGES.

| J&B # | DESCRIPTION | QTY |
|-------|------------------------|-----|
| 41407 | TYPE 1, ADAPTER FLANGE | EA |



ALUMINUM CUT-OFF WHEELS

FOR USE ON RIGHT ANGLE GRINDERS



- For cutting non-ferrous metals...aluminum, copper, brass, etc. Made of aluminum oxide grain.
- Soft bond for aggressive cutting without loading.
- Use with reusable 5/8-11 adapter to fit angle grinders.

| J&B # | MFG # | SIZE | | | TYPE | MAX RPM | QTY |
|-------|-------|-------|------|-------|------|---------|-----|
| | | DIA | THK | ARBOR | | | |
| 42065 | 23314 | 4-1/2 | .045 | 7/8 | 1 | 13,300 | 10 |

ABRASIVE PRODUCTS

CUT-OFF WHEELS Depressed Center

FOR USE ON RIGHT ANGLE GRINDERS



- The Razorblade 27 wheel combines fast, chatter free cutting with exceptional wheel life, making it the wheel of choice where wheel usage is high and wheel change downtime is a concern.
- Facilitates flush cutting on flat surfaces.

| J&B # | MFG # | SIZE | | | TYPE | GRADE | MAX RPM | QTY |
|--------|-------|-------|--------|-------|------|-----------|---------|-----|
| | | DIA | THK | ARBOR | | | | |
| 42042 | A0481 | 4-1/2 | x .045 | x 7/8 | 27 | A60SST-27 | 13,300 | 10 |
| V41989 | A2481 | 6 | x .045 | x 7/8 | 27 | A60SST-27 | 10,000 | 10 |

CUT-OFF WHEEL Depressed Center

- Unique, thin type 27/ type 42 shape can be used on all angle grinders in accordance with ANSI B7.1.
- Unique formulations offer the fastest cutting, longest lasting thin wheels.
- Externally reinforced with fiberglass layers to provide ultimate safety in a thin wheel.
- Proprietary bonding system allows for faster, burr free cuts.



| J&B # | MFG # | SIZE | | | TYPE | GRADE | MAX RPM | QTY |
|-------|-------|-------|--------|-------|---------|-------|---------|-----|
| | | DIA | THK | ARBOR | | | | |
| 49108 | 22021 | 4-1/2 | x .045 | x 7/8 | 27 / 42 | A60S | 13,300 | 10 |

ABRASIVE PRODUCTS

PORTABLE SAW CUT-OFF WHEELS Extremely Fast Cutting

- Special aluminum oxide grain formula.
- Fast cutting action. Non-binding cutting formula.
- Externally reinforced with the highest quality fiberglass.
- Cuts ferrous metals, stainless steel, high tensile alloys.



| J&B # | MFG # | SIZE | | TYPE | GRADE | MAX RPM | QTY |
|-------|-------|------|--------------|------|-------|---------|-----|
| | | DIA | THK ARBOR | | | | |
| 39149 | 24160 | 14 x | 1/8 x 20mm | 1 | XFC | 5,460 | 1 |

ABRASIVE PRODUCTS

CUBITRON CUT-OFF WHEELS

FOR USE ON PENCIL & DIE GRINDERS



- Cubitron Cut-Off Wheels are designed to provide high cut rates and long life on most all materials including fiberglass, stainless steel, mild steel and aerospace alloys.
- Cubitron Wheels incorporate 3M's patented **Cubitron** ceramic abrasive grain technology and are ideal for use on a wide variety of utility type cut-off tools.

| J&B # | SIZE | HOLE | MAX RPM | QTY |
|--------|----------|------|---------|-----|
| *41860 | 3 x 1/16 | 3/8" | 26,000 | 5 |
| *45570 | 4 x 1/32 | 3/8" | 26,250 | 5 |

*No broken boxes

CUT-OFF WHEELS

FOR USE ON PENCIL & DIE GRINDERS

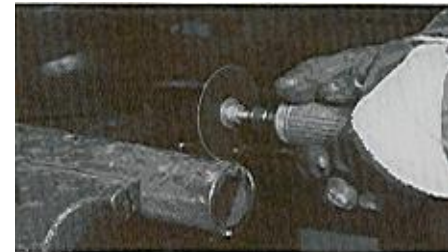

- Aluminum oxide grain, hard bond for aggressive cutting on rough applications.
- Easily cuts through tubes, pipes, sheet metal.

| J&B # | MFG # | SIZE | HOLE | MATERIAL | MAX RPM | QTY |
|--------|-------|--------------|------|----------|---------|-----|
| *40249 | F0220 | 2-1/2 x 1/16 | 3/8 | A36T | 24,446 | 10 |
| 40256 | 23051 | 3 x .035 | 3/8 | A60T | 25,000 | 10 |
| *42168 | F0310 | 3 x .035 | 3/8 | A60T | 25,000 | 10 |
| 40250 | 23040 | 3 x 1/16 | 3/8 | A36T | 25,000 | 10 |
| 40252 | 23065 | 4 x 1/16 | 3/8 | A36T | 19,000 | 10 |

* = Flexovit Brand



| J&B # | FITS WHEEL SIZE OF: THICKNESS | ARBOR | SHANK SIZE | QTY |
|-------|-------------------------------|------------|------------|-----|
| 40255 | .035 to 1/2 | 3/8 | 1/4 | EA |
| 40251 | .035 to 3/16 | 3/8 or 1/4 | 1/4 | EA |

* These mandrel adapters fit 2" to 4" diameter wheels.

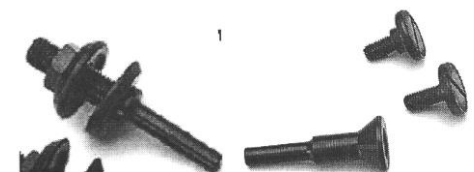

40255

40251

ABRASIVE PRODUCTS

CHOPSAW WHEELS

FOR USE ON CHOPSAWS



- General purpose for profiles and solids; carbon or alloy steels.
- Made of reinforced resinoid for longer life.

| J&B # | MFG # | SIZE | HOLE | MATERIAL | MAX RPM | QTY | CASE |
|-------|-------|-----------|------|----------|---------|-----|------|
| 39062 | 24034 | 12 x 3/32 | 1" | A30RB | 5,100 | EA | 10 |
| 39064 | 24039 | 14 x 3/32 | 1" | A30RB | 4,400 | EA | 10 |

REDUCING BUSHINGS

- For use with type 1 cut-off wheels.
- Reduces wheel arbor size.

| J&B # | SIZE | QTY |
|-------|-----------|-----|
| 13757 | 7/8 – 5/8 | 10 |
| 13756 | 1" – 7/8 | 10 |
| 13755 | 1" – 20mm | 10 |



CIRCULAR SAW WHEELS

FOR USE ON
CIRCULAR SAWS



- Fast cut metal, stainless.
- A general purpose wheel, ideal on carbon or stainless steel shapes or profiles.
- Provides fast cutting action.

| J&B # | MFG # | SIZE | HOLE | MATERIAL | MAX RPM | QTY | CASE |
|-------|-------|----------|------|----------|---------|-----|------|
| 45630 | 23230 | 7 x 3/32 | 5/8 | A24R | 8,500 | EA | 25 |

ABRASIVE PRODUCTS

SHOP ROLLS

Aluminum Oxide

FOR HAND USE



- Aluminum oxide abrasive, cloth-backed, glue bonded.
- Comes in handy dispenser box.



| J&B # | GRIT | LENGTH | WIDTH | QTY |
|-------|------|--------|-------|-----|
| 20880 | 60 | 50 YDS | 1-1/2 | EA |
| 20773 | 80 | 50 YDS | 1-1/2 | EA |
| 20774 | 100 | 50 YDS | 1-1/2 | EA |
| 20775 | 120 | 50 YDS | 1-1/2 | EA |
| 20881 | 150 | 50 YDS | 1-1/2 | EA |
| 20778 | 180 | 50 YDS | 1-1/2 | EA |
| 20776 | 240 | 50 YDS | 1-1/2 | EA |
| 20777 | 320 | 50 YDS | 1-1/2 | EA |
| 20779 | 400 | 50 YDS | 1-1/2 | EA |

REGULAR BELTS

Aluminum Oxide

FOR USE ON BELTSANDERS

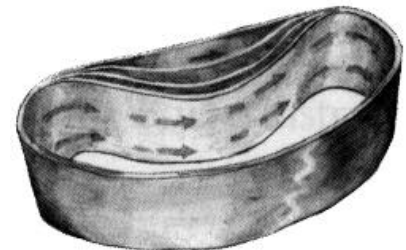

| J&B # | GRIT | LENGTH | WIDTH | QTY |
|--------|------|--------|-------|-----|
| *41956 | 120 | 18 " | 3/4 | 100 |

* If breaking a box, must be done in multiples of 10.

ABRASIVE PRODUCTS

ABRASIVE SCREEN

FOR HAND USE



- Made of nylon mesh impregnated with a silicone carbide abrasive.
- Can be used **wet or dry** on metal, wood, and plastic applications.
- Screen mesh design **prevents loading**.
- Can be used on both sides.



| J&B # | SIZE | GRIT | QTY |
|-------|----------------|------|-----|
| 20149 | 1-1/2 x 75 Ft. | 120 | EA |

CROCUS CLOTH ROLL

FOR HAND USE



- Sharp, long lasting aluminum oxide abrasive.
- Excellent for extra **fine polishing** of metals.



| J&B # | SIZE | QTY |
|-------|-----------------|-----|
| 20151 | 1-1/2 x 20 Yds. | EA |

ABRASIVE PRODUCTS

PSA SANDING DISCS Stikit

- Pressure sensitive adhesive for press-on, peel-off convenience.
- Discs resist loading and reduce “down time”.
- For use on paint, primer, wood, metal and fiberglass.
- All discs below have no holes.



ORDER BY THE ROLL

| J&B # | 3M # | COLOR | SIZE | GRIT | QTY |
|-------|--------------|-------|------|-----------|--------|
| 40710 | 051144-21799 | GOLD | 5" | 80F | 100/RL |
| 45730 | 35412 (SAIT) | WHITE | 5" | P120 (6A) | 100/RL |
| 45610 | 35413 (SAIT) | WHITE | 5" | P150 | 100/RL |

* Cannot break roll quantity.

ORDER BY THE ROLL

PSA BACKING PAD

- For use with PSA adhesive backed sanding discs.
- Threaded pad for dual action/random orbital sanders and right angle grinders/sanders.

| J&B # | SIZE | QTY |
|-------|-------------|-----|
| 41961 | 5 x 5/16-24 | EA |

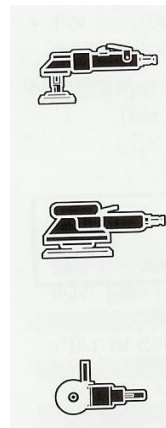

ABRASIVE PRODUCTS

FOR HAND USE

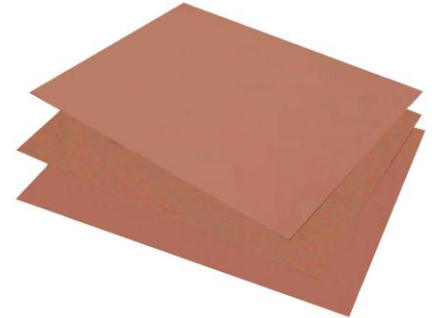

ALUMINUM OXIDE PAPER Open Coat

- Dry sanding only. Open coat resists loading.
- Effective for removing scratches and burrs on metal, shaping and finishing plastic filler, and stripping old paint or varnish off wood.

| J&B # | SIZE | GRIT | QTY |
|-------|--------|------|-----|
| 9454 | 9 x 11 | 80D | 50 |

EMERY CLOTH

- Used for general purpose metal sanding such as light cleanup work and rust removal jobs.

| J&B # | SIZE | GRIT | QTY |
|-------|--------|------|-----|
| 38058 | 9 x 11 | FINE | EA |
| 38969 | 9 x 11 | MED | EA |

CROCUS CLOTH

- Sharp, long lasting aluminum oxide abrasive.
- Excellent for extra fine polishing of metals.

| J&B # | SIZE | QTY |
|-------|--------|-----|
| 38968 | 9 x 11 | EA |

ABRASIVE PRODUCTS

TAPERED CARTRIDGE MANDRELS

| J&B # | SHANK DIA. | PILOT LENGTH | PILOT DIA. | QTY |
|-------|------------|--------------|------------|-----|
| 41966 | 1/4" | 1" | 1/8 | EA |
| 41970 | 1/4" | 1-1/2" | 3/16 | EA |



STEEL WOOL

- Heavy duty grade for removing rust, cleaning car engines & removing accumulations of paint & varnish on floors & furniture.
- Packaged in bags of 12.

| J&B # | GRADE | STYLE | QTY |
|-------|-------|--------------|-------|
| 40393 | #4 | EXTRA COARSE | 1 BAG |

(ORDERING 1 = 1 BAG OF 12)

** NO BROKEN BAGS



STRIP DISC

- Fast, safe removal of surface contaminants.
- Excellent for cleaning welds, removing corrosion, rust, scaling and blending.
- Great for removing paints, varnishes & sealants from Difficult to reach surfaces.

| J&B # | SIZE | MAX RPM | QTY |
|-------|------|---------|-----|
| 45732 | 2" | 12,000 | 5 |
| 45733 | 3" | 8,500 | 5 |
| 45960 | 4" | 12,000 | EA |

| J&B # | SIZE | QTY |
|-------|---------------------|-----|
| 40448 | 2" Arbor 1/4" Shank | EA |
| 40449 | 3" Arbor 1/4" Shank | EA |



ABRASIVE PRODUCTS

HUB CLEANING DISC

- Extremely tough non-woven web removes rust & corrosion without excessive metal removal or gouging.
- Contains no wire filaments.
- Ideal for effective removal of buildup on brakes.
- Made of silicon carbide mineral that cuts sharp.
- Disc features a hollow center, enabling operators to slide over and around hub without damaging the stud threads.



| J&B # | SIZE | GRIT | STYLE | QTY |
|-------|------------------------------|------|--------------|-----|
| 49090 | 1-1/2 | 100 | EXTRA COARSE | 10 |
| 49091 | Holder for hub cleaning disc | | | EA |

ABRASIVE PRODUCTS

3M SCOTCH-BRITE HAND PADS

General Purpose Pad



- Made of nylon web - rinse clean – can be used over and over again.
- Handy for doing many chores from Cleaning metal surfaces to sanding wood or ceramic materials.
- Use in a dry medium or with lubricants such as water or oil.

| J&B # | SIZE | GRIT | COLOR | QTY |
|--------|-------|------------|------------|-----|
| *40391 | 6 x 9 | SUPER FINE | WHITE | 20 |
| *12250 | 6 x 9 | FINE | LIGHT GRAY | 20 |
| *40700 | 6 x 9 | MEDIUM | MAROON | 20 |
| *42063 | 6 x 9 | COARSE | DARK GRAY | 20 |

* Sold in full boxes only.

ALUMINUM OXIDE MOUNTED FLAP WHEELS

- For cleaning, deburring, finishing, and polishing of flat or contoured metal surfaces.
- Hugs concave or convex surfaces, allowing access to hard-to-reach areas.
- Non-loading; the flexibility provided by the coated abrasive flaps prevents loading which occurs with non-flexible grinding products.
- Mandrel mounted on fixed 1/4" solid shank.

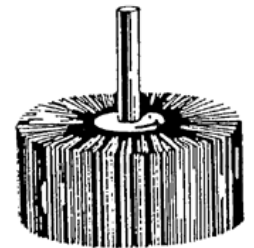

| J&B # | WHEEL DIAMETER | FACE WIDTH | GRIT | MAX RPM | QTY |
|-------|----------------|------------|------|---------|-----|
| 49093 | 1" | 1" | 40 | 30,000 | EA |
| 40654 | 1" | 1" | 60 | 30,000 | EA |
| 40655 | 1" | 1" | 80 | 30,000 | EA |
| 42385 | 1" | 1" | 120 | 30,000 | EA |
| 42387 | 1-1/2" | 1" | 60 | 25,000 | EA |
| 42388 | 1-1/2" | 1" | 80 | 25,000 | EA |
| 40665 | 1-1/2" | 1" | 120 | 25,000 | EA |
| 49094 | 2" | 1" | 40 | 25,000 | EA |
| 42391 | 2" | 1" | 60 | 25,000 | EA |
| 40660 | 2" | 1" | 80 | 25,000 | EA |
| 40662 | 2" | 1" | 120 | 25,000 | EA |
| 40664 | 2" | 1" | 180 | 25,000 | EA |
| 40667 | 2-1/2" | 1" | 60 | 23,000 | EA |
| 42393 | 2-1/2" | 1" | 80 | 23,000 | EA |
| 40668 | 2-1/2" | 1" | 120 | 23,000 | EA |
| 42395 | 3" | 1" | 60 | 23,000 | EA |
| 49095 | 3" | 1" | 80 | 23,000 | EA |
| 42397 | 3" | 1" | 120 | 23,000 | EA |

ABRASIVE PRODUCTS

ROL-ON SANDING DISCS

FOR USE ON RIGHT ANGLE SANDERS & GRINDERS



- It is a handy quick change tool for disc grinding.
- Fits any 1/4" drill or air tool.
- Connects quickly and easily to its arbor with a 1/2" right twist and removes with a 1/2" left twist.



| J&B # | SIZE | GRIT | QTY |
|---------|------|------|-----|
| * 41952 | 2" | 120 | 50 |
| 38903 | 2" | 80 | 25 |
| * 41981 | 2" | 80 | 50 |
| 38893 | 2" | 50 | 25 |
| * 41980 | 2" | 50 | 50 |
| 38894 | 2" | 36 | 25 |
| ^ 41899 | 2" | 36 | 25 |
| * 41950 | 2" | 36 | 50 |
| 38895 | 2" | 24 | 25 |
| ^ 41901 | 2" | 24 | 25 |
| * 41979 | 2" | 24 | 50 |
| 39029 | 3" | 120 | 25 |
| 38966 | 3" | 80 | 25 |
| * 41985 | 3" | 50 | 50 |
| 38896 | 3" | 50 | 25 |
| * 41986 | 3" | 36 | 50 |
| 38897 | 3" | 36 | 25 |
| * 41987 | 3" | 24 | 50 |
| 38898 | 3" | 24 | 25 |

| J&B # | SIZE | QTY |
|-------|---------------------|-----|
| 40448 | 2" Arbor 1/4" Shank | EA |
| 40449 | 3" Arbor 1/4" Shank | EA |

* 3M discs.

^ Shark discs.

ROL-ON BRISTLE DISCS

- Ideal for cleaning, finishing, blending and deburring.
- Used on corners, welds and for rivet cleaning on all areas where conformability is required.
- Eliminate dangerous flying wires.

| J&B # | SIZE | GRIT | COLOR | QTY |
|-------|------|--------|--------|-----|
| 42164 | 2" | FINE | WHITE | 5 |
| 42160 | 2" | MEDIUM | YELLOW | 5 |
| 42162 | 2" | COARSE | GREEN | 5 |
| 42163 | 3" | COARSE | GREEN | 5 |



*Use arbor 40448 for 2" bristle disc & 40449 for 3".

ABRASIVE PRODUCTS

TRIM-KUT DISCS

FOR USE ON RIGHT ANGLE SANDERS & GRINDERS

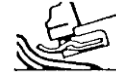

- Trim-Kut abrasive discs are a unique one piece design with the grinding surface bonded to a hard copolymer backing.
- No backing pad required.
- Grinds, sands, levels weld seams and is an excellent rust/paint remover.
- Aluminum oxide discs.

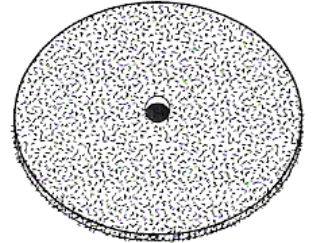

| J&B # | SIZE | PRINT COLOR | GRIT | QTY |
|-------|------|-------------|------|-----|
| 20441 | 3" | WHITE | 24 | 25 |
| 20442 | 3" | RED | 36 | 25 |
| 20443 | 3" | ORANGE | 60 | 25 |
| 20444 | 3" | GREEN | 120 | 25 |

* All boxes contain 1 mandrel.

HEX PREMIUM MANDREL

| J&B # | SIZE | QTY |
|-------|------|-----|
| 20450 | 1/4" | EA |

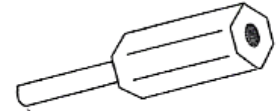

MINI FLAP DISCS

- Long life performance of a flap disc for use in confined spaces.
- More material, longer life than a single layer laminated disc.
- Roloc style allows easy changeover.



| J&B # | SIZE | GRIT | QTY |
|-------|-----------------------|------|-----|
| 59114 | 2" | 40 | EA |
| 59115 | 2" | 80 | EA |
| 59117 | 3" | 40 | EA |
| 59118 | 3" | 80 | EA |
| 40448 | 2" Arbor (1/4" shank) | | EA |
| 40449 | 3" Arbor (1/4" shank) | | EA |

ABRASIVE PRODUCTS

ROLON SURFACE CONDITIONING DISCS

FOR USE ON RIGHT ANGLE SANDERS & GRINDERS



- Non-woven surface conditioning products are ideal for deburring, cleaning, blending, and polishing.
- Use on mild steel, stainless, aluminum, plastic or wood.
- Connects quickly and easily to its arbor with a 1/2 right twist and removes with a 1/2 left twist.



| J&B # | SIZE | GRIT | COLOR | QTY |
|----------|-----------------------|--------|--------|-----|
| 38899 | 2" | FINE | BLUE | 25 |
| ^ 41988 | 2" | FINE | BLUE | 25 |
| 40440 | 2" | MEDIUM | MAROON | 25 |
| ^ 41893 | 2" | MEDIUM | MAROON | 25 |
| ^ 41894 | 2" | MEDIUM | MAROON | 50 |
| ** 20449 | 2" | MEDIUM | MAROON | 50 |
| 40442 | 2" | COARSE | BROWN | 25 |
| ^ 41895 | 2" | COARSE | BROWN | 25 |
| ^ 41896 | 2" | COARSE | BROWN | 50 |
| ** 20448 | 2" | COARSE | BROWN | 50 |
| 38900 | 3" | FINE | BLUE | 25 |
| ^ 41932 | 3" | FINE | BLUE | 25 |
| 40444 | 3" | MEDIUM | MAROON | 25 |
| ^ 41897 | 3" | MEDIUM | MAROON | 25 |
| 40446 | 3" | COARSE | BROWN | 25 |
| ^ 41898 | 3" | COARSE | BROWN | 25 |
| 40448 | 2" Arbor (1/4" shank) | | | EA |
| 40449 | 3" Arbor (1/4" shank) | | | EA |

** GEMTEX

^ SHARK

VELCRO SURFACE CONDITIONING DISCS

FOR USE ON RIGHT ANGLE SANDERS & GRINDERS



- Non-woven surface conditioning products are ideal for deburring, cleaning, blending, and polishing.
- Use on mild steel, stainless, aluminum, plastic or wood.
- This disc pad connects quickly and easily to any power tool while holding surface conditioning discs securely and safely through the use of dual lock fastening system.



| J&B # | SIZE | GRIT | COLOR | QTY |
|-------|-----------------------|--------|--------|-----|
| 40420 | 2" | MEDIUM | MAROON | 25 |
| 40422 | 2" | COARSE | BROWN | 25 |
| 40430 | 2" Arbor (1/4" shank) | | | EA |

ABRASIVE PRODUCTS

INTERLEAF WHEELS

- Mandrel mounted on fixed 1/4" solid shank.
- Medium grade. Excellent for removing heavy oxidation, blending, cleaning and deburring.
- Very fine grade. Excellent for grain finishing, satin finishing and linear scratch patterns.

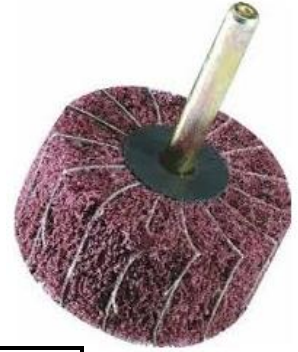

| J&B # | DIA x THICKNESS | GRIT | GRADE | MAX RPM | QTY |
|-------|-----------------|------|-----------|---------|-----|
| 46130 | 2 x 1 | 60 | MEDIUM | 15,000 | EA |
| 46131 | 2 x 1 | 80 | MEDIUM | 15,000 | EA |
| 46132 | 2 x 1 | 120 | VERY FINE | 15,000 | EA |

NON WOVEN SURFACE CONDITIONING DISCS

Hook & Loop

FOR USE ON RIGHT ANGLE GRINDERS



- Ideal for deburring, cleaning, blending and polishing.
- Use on mild steel, stainless, aluminum, plastic or wood.
- Gripper pad is made perfectly flat from high impact plastics to ensure maximum support and disc adhesion.

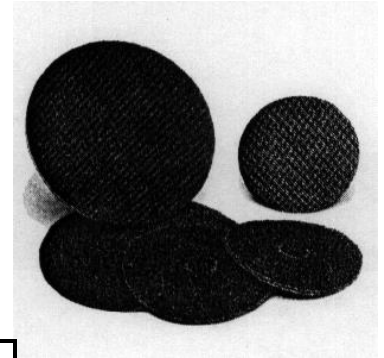

| J&B # | SIZE | GRIT | COLOR | QTY |
|-------|--------------------------------|--------|--------|-----|
| 45680 | 7" | FINE | BLUE | 10 |
| 45681 | 7" | MEDIUM | MAROON | 10 |
| 45682 | 7" | COARSE | BROWN | 10 |
| 45683 | 7" Gripper Pad (5/8-11" shank) | | | EA |

ROLOC UNITIZED WHEEL

- Roloc unitized wheels are strong, efficient products for edge deburring and finishing.
- They perform well in a variety of metal working applications and on intricate machined parts where close tolerances are important.
- The Roloc holding systems make changing unitized wheels quick and easy.



| J&B # | SIZE | GRIT | COLOR | QTY |
|-------|-----------------------|--------|-------|-----|
| 40477 | 2" | MEDIUM | TAN | 5 |
| 40448 | 2" Arbor (1/4" shank) | | | EA |

ABRASIVE PRODUCTS

MOUNTED GRINDING STONES

Premium Quality

FOR USE ON DIE GRINDERS



- Aluminum oxide vitrified bonded wheels are for all kinds of grinding, deburring, blending and contouring of ferrous and non-ferrous metals.
- Different shapes give access to hard-to-reach areas.



40680
(IND. # A3)



40681
(IND. # A11)



40682
(IND. # A21)

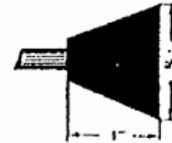

40683
(IND. # A31)



40684
(IND. # A36)



40685
(IND. # B52)



40686
(IND. # W163)



40687
(IND. # W185)

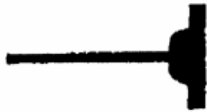

40688
(IND. # W215)



40689
(IND. # W220)



40690
(IND. # W235)



40691
(IND. # W236)

| J&B # | IND # | ABRASIVE SHAPE | | MANDREL SIZE | MAX RPM | QTY |
|-------|-------|----------------|-------|--------------|---------|-----|
| | | DIAM | THICK | | | |
| 40680 | A3 | 1 | 2-3/4 | 1/4 | 16,100 | 2 |
| 40681 | A11 | 7/8 | 2 | 1/4 | 19,860 | 2 |
| 40682 | A21 | 1 | 1 | 1/4 | 34,500 | 2 |
| 40683 | A31 | 1-3/8 | 1 | 1/4 | 27,780 | 2 |
| 40684 | A36 | 1-5/8 | 3/8 | 1/4 | 23,520 | 2 |
| 40685 | B52 | 3/8 | 3/4 | 1/8 | 45,370 | 2 |
| 40686 | W163 | 1/4 | 1/2 | 1/8 | 60,000 | 2 |
| 40687 | W185 | 1/2 | 1/2 | 1/8 | 34,500 | 2 |
| 40688 | W215 | 1 | 1/8 | 1/8 | 38,200 | 2 |
| 40689 | W220 | 1 | 1 | 1/4 | 25,500 | 2 |
| 40690 | W235 | 1-1/2 | 1/4 | 1/4 | 25,470 | 2 |
| 40691 | W236 | 1-1/2 | 1/2 | 1/4 | 25,470 | 2 |

GROUP A SHAPES: Use for medium to heavy duty blending and contouring.

GROUP B SHAPES: Best for light deburring and blending.

GROUP W SHAPES: Suited for off-handed and precision grinding where medium to heavy stock removal is required.



ABRASIVE PRODUCTS

WIRE END BRUSHES

FOR USE ON STRAIGHT GRINDERS

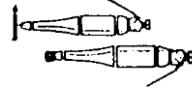

- Use crimped for softer and knotted for more aggressive brushing.
- Use with portable tools or drill presses.
- Ideal for tight to get at areas and blind holes.



APPLICATIONS:

- Carbon Cleaning
- Die, Mold and Tool Polishing
- Rust or Paint Removal
- Burr Removal
- Weld Cleaning
- Rubber or Plastic Removal
- Spot Facing
- Cleaning Castings

42120 / 20960 /

20961

CRIMPED

45702 /

41192

KNOTTED

| J&B # | DIA | SHANK | WIRE SIZE | TRIM LENGTH | MAX. SAFE FREE SPEED (RPM) | QTY |
|-------|--------|-------|-----------|-------------|----------------------------|-----|
| 20960 | 1/2" | 1/4" | .020 | 1" | 22,000 | EA |
| 20961 | 1" | 1/4" | .020 | 1" | 20,000 | EA |
| 42120 | 1-3/4" | 1/4" | .012 | 1" | 20,000 | EA |
| 45702 | 3/4" | 1/4" | .014 | 1" | 20,000 | EA |
| 41192 | 1-1/8" | 1/4" | .020 | 1" | 20,000 | EA |

TUBE BRUSH

- Deburring and cleaning drilled holes and internal threads, cleaning and finishing internal diameters of pipes and tubes, deburring and cleaning keyways and grooves.

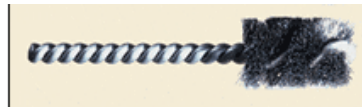

| J&B # | DIA | BRUSH LENGTH | OVERALL LENGTH | FILAMENT/ DIAMETER | QTY |
|-------|------|--------------|----------------|--------------------|-----|
| 41326 | 7/8" | 1" | 3-1/2" | .006 CARBON | EA |

ABRASIVE PRODUCTS

KNOT WIRE CUP BRUSH

FOR USE ON ANGLE GRINDERS



- Knot wheels provide high impact brushing action for heavy surface conditioning applications.

| J&B # | DIA | ARBOR | WIRE SIZE | MATERIAL | MAX. SAFE FREE SPEED (RPM) | QTY |
|--------|--------|--------|-----------|----------|----------------------------|-----|
| V41877 | 2-3/4" | 5/8-11 | .020 | Carbon | 14,000 | EA |
| 41790 | 3-1/2" | 5/8-11 | .020 | Carbon | 12,500 | EA |
| 41193 | 4" | 5/8-11 | .020 | Carbon | 9,000 | EA |

LARGE CRIMPED WIRE CUP BRUSH

FOR USE ON LARGE ANGLE GRINDERS



- For general purpose cleaning and deburring.
- Ideal for light cleaning and paint removal.
- Ideal for flat surfaces and edge cleaning.

| J&B # | DIA | ARBOR | WIRE SIZE | MATERIAL | MAX. SAFE FREE SPEED (RPM) | QTY |
|-------|--------|--------|-----------|----------|----------------------------|-----|
| 41791 | 2-3/4" | 5/8-11 | .014 | Carbon | 14,000 | EA |
| 41872 | 3-1/2" | 5/8-11 | .014 | Carbon | 12,500 | EA |

CRIMPED WIRE CUP BRUSH

FOR USE ON DIE GRINDERS, POWER DRILLS, RIGHT ANGLE AIR DIE GRINDERS



| J&B # | DIA | ARBOR | WIRE SIZE | MATERIAL | MAX. SAFE FREE SPEED (RPM) | QTY |
|-------|-----|-------|-----------|----------|----------------------------|-----|
| 45729 | 2" | 1/4" | .0118 | Carbon | 13,000 | EA |

ABRASIVE PRODUCTS

CRIMPED WIRE WHEEL

FOR USE ON ANGLE GRINDERS



- For light rust and oxide removal, cleaning and conditioning.
- Crimped wire wheel brushes have higher flexibility than knotted wire for application on irregular surfaces and where lighter brushing is required.

| J&B # | DIAM | FACE | ARBOR | WIRE SIZE | MAX. SAFE FREE SPEED (RPM) | QTY |
|-------|------|------|--------|-----------|----------------------------|-----|
| 40433 | 4" | 1/2" | 5/8-11 | .014 | 15,000 | EA |

KNOTTED WIRE WHEEL

FOR USE ON ANGLE GRINDERS



- Provide high impact action to remove weld scale and splatter.
- Ideal for general cleaning.

| J&B # | DIAM | FACE | ARBOR | WIRE SIZE | MAX. SAFE FREE SPEED (RPM) | QTY |
|-------|------|------|--------|-----------|----------------------------|-----|
| 40434 | 4" | 3/8" | 5/8-11 | .020 | 20,000 | EA |

ABRASIVE PRODUCTS

KNOTTED WIRE WHEEL

FOR USE ON RIGHT ANGLE SANDERS & GRINDERS



- Cleaning, deburring, roughening.

| J&B # | DIAM | FACE | ARBOR | WIRE SIZE | MAX. SAFE FREE SPEED (RPM) | QTY |
|-------|------|------|-------|-----------|----------------------------|-----|
| 45731 | 3" | 3/8" | 1/4" | .014 | 25,000 | EA |
| 49092 | 4" | 5/8" | 1/4" | .020 | 20,000 | EA |

CRIMPED WIRE WHEEL

FOR USE ON RIGHT ANGLE SANDERS & GRINDERS



- For light to medium duty applications

Hex Arbor

| J&B # | DIAM | THICK | ARBOR | WIRE SIZE | MAX RPM | QTY |
|-------|------|-------|-------|-----------|---------|-----|
| 38667 | 2" | 3/8 | 1/4" | .012 | 5,000 | EA |
| 38668 | 3" | 3/8 | 1/4" | .012 | 4,500 | EA |
| 38669 | 3" | 3/8 | 1/4" | .008 | 4,500 | EA |



Smooth Arbor

| J&B # | DIAM | THICK | ARBOR | WIRE SIZE | MAX RPM | QTY |
|-------|--------|-------|-------|-----------|---------|-----|
| 38666 | 1-1/2" | 3/8 | 1/4" | .012 | 20,000 | EA |
| 43012 | 2" | 3/8 | 1/4" | .012 | 20,000 | EA |
| 43013 | 3" | 1/2 | 1/4" | .008 | 20,000 | EA |
| 43014 | 3" | 1/2 | 1/4" | .014 | 20,000 | EA |



ABRASIVE PRODUCTS

CRIMPED WIRE WHEELS

Carbon Steel

FOR USE ON BENCH GRINDERS

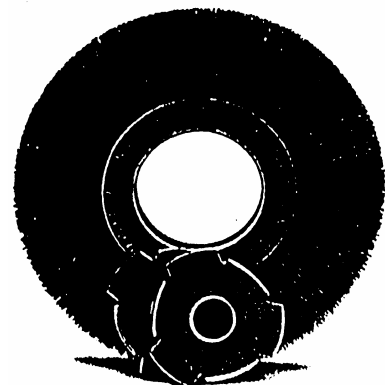

- Designed for maximum productivity; good filament density and additional section construction for extra rigidity.
- Excellent for refining metal surfaces, preparing rubber in vulcanizing, blending surfaces, removing light burrs, paint and corrosion.

| J&B # | DIAM. | WIRE SIZE | WIDTH | ARBOR | MAX RPM | QTY |
|-------|-------|-----------|-------|----------|---------|-----|
| 39175 | 6" | .014 | 1/2" | 1/2, 5/8 | 6,000 | EA |
| 39094 | 8" | .014 | 1" | 1/2, 5/8 | 4,500 | EA |

* Part #39094 comes with 1/2 and 5/8 arbor; 3/4 arbor must be ordered separately.

| J&B # | ARBOR |
|-------|----------------------|
| 1403 | 3/4 - (for 8" wheel) |

T-C CARBON STEEL WHEELS

FOR USE ON MINI GRINDERS

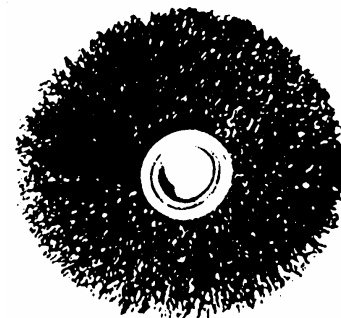

- Designed for use in restricted or hard-to-reach areas.
- Used for deburring, blending and cleaning of surfaces.

| J&B # | DIAM. | WIRE SIZE | WIDTH | ARBOR | MAX RPM | QTY |
|-------|--------|-----------|-------|-------|---------|-----|
| 40141 | 2" | .012 | 1/4 | 1/2 | 20,000 | EA |
| 40142 | 2-1/2" | .014 | 1/4 | 1/2 | 20,000 | EA |
| 40143 | 3" | .012 | 1/4 | 1/2 | 20,000 | EA |

ARBOR

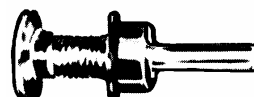

Metal arbor for use in portable tools and drill presses with 1/4" capacity chucks 1/4" shank, 1/2" diameter brush to be used in adapting small diameter brushes with 1/2" diameter hole. **DO NOT USE WITH GRINDING WHEELS.**

| J&B # | QTY |
|-------|-----|
| 40140 | EA |



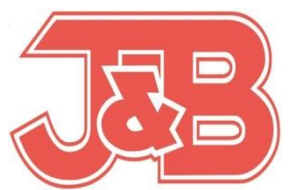
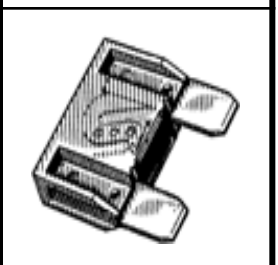
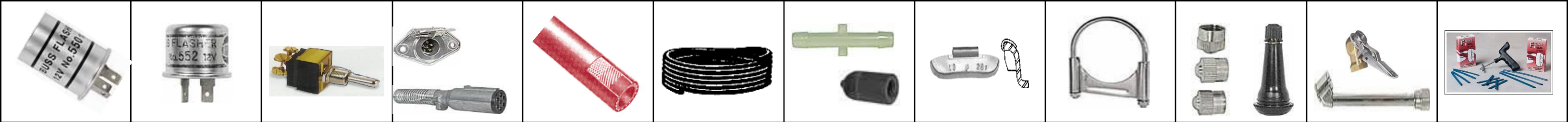

PART# 2851

J&B Fleet - Industrial Supply

22428 Harrisburg-Westville Rd. Alliance, Ohio 44601 Phone: (330) 821-6342 Fax: (330) 821-0411

www.jbfleet.com

2" SANDING DISCS

41979

2" 24 GRIT

10

41950

2" 36 GRIT

10

41980

2" 50 GRIT

10

41981

2" 80 GRIT

10

41952

2" 120 GRIT

10

40448

2" ARBOR

1



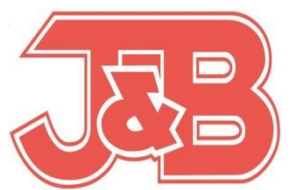
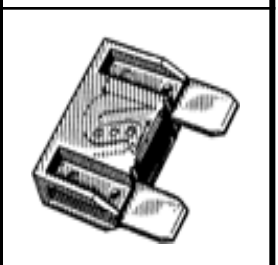

PART# 2852

J&B Fleet - Industrial Supply

22428 Harrisburg-Westville Rd. Alliance, Ohio 44601 Phone: (330) 821-6342 Fax: (330) 821-0411

www.jbfleet.com

2" SANDING DISCS

| | | | |
|---|--|--|--|
| <p>38895</p> <p>2" 24 GRIT</p> <p>10</p> | <p>38894</p> <p>2" 36 GRIT</p> <p>10</p> | <p>38893</p> <p>2" 50 GRIT</p> <p>10</p> | <p>38903</p> <p>2" 80 GRIT</p> <p>10</p> |
| <p>41952</p> <p>2" 120 GRIT</p> <p>10</p> | | | <p>40448</p> <p>2" ARBOR</p> <p>1</p> |



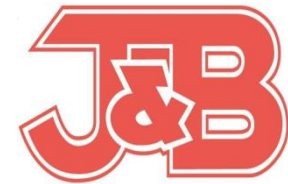
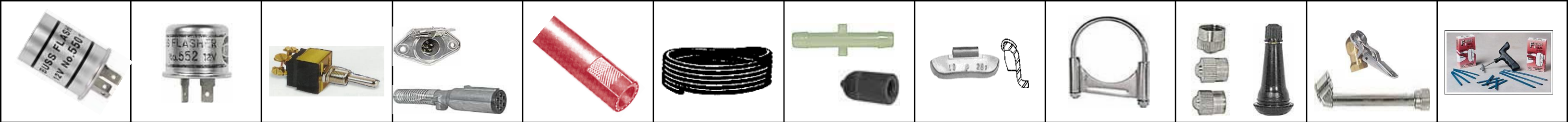

J&B Fleet - Industrial Supply

22428 Harrisburg-Westville Rd. Alliance, Ohio 44601 Phone: (330) 821-6342 Fax: (330) 821-0411

www.jbfleet.com

PART# 2853

3" SANDING DISCS

38898



3" 24 GRIT

10

38897



3" 36 GRIT

10

38896



3" 50 GRIT

10

38966



3" 80 GRIT

10

40449



3" ARBOR

1

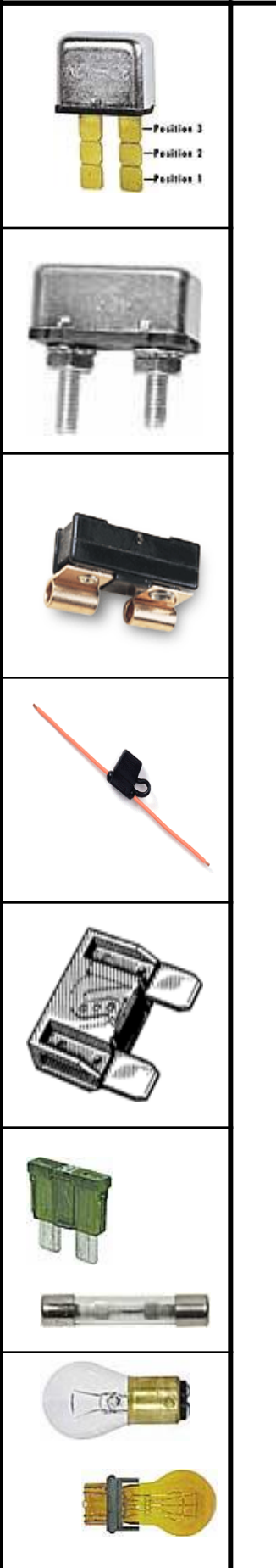

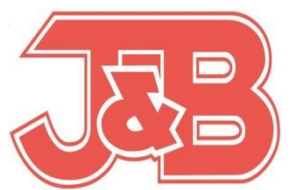
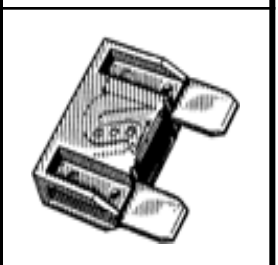



PART# 2854

J&B Fleet - Industrial Supply

22428 Harrisburg-Westville Rd. Alliance, Ohio 44601 Phone: (330) 821-6342 Fax: (330) 821-0411

www.jbfleet.com

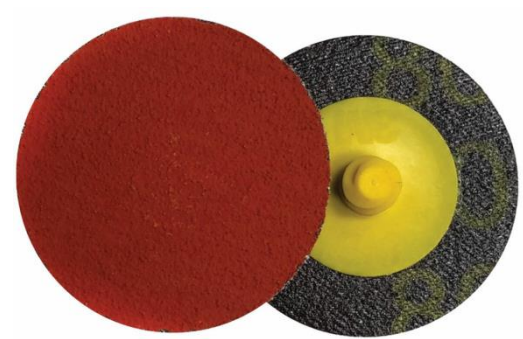
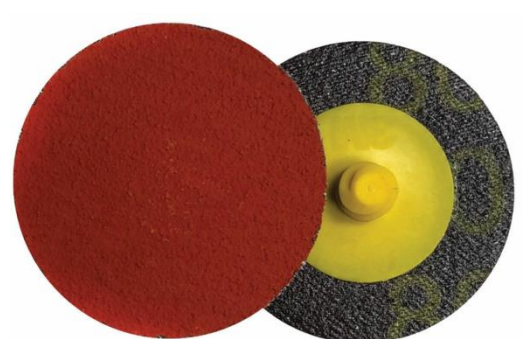
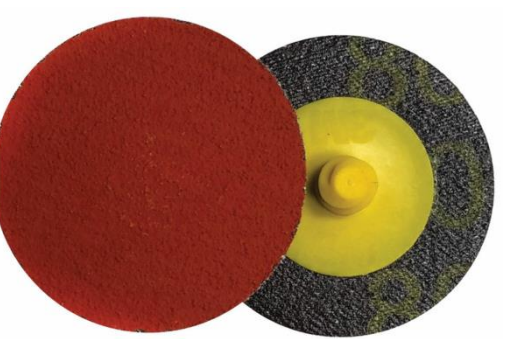
3" SANDING DISCS

| | | | |
|---|---|---|---|
| <p style="text-align: center;">41987</p>  <p style="text-align: center;">3" 24 GRIT</p> <p style="text-align: center;">10</p> | <p style="text-align: center;">41986</p>  <p style="text-align: center;">3" 36 GRIT</p> <p style="text-align: center;">10</p> | <p style="text-align: center;">41985</p>  <p style="text-align: center;">3" 50 GRIT</p> <p style="text-align: center;">10</p> | <p style="text-align: center;">38966</p>  <p style="text-align: center;">3" 80 GRIT</p> <p style="text-align: center;">10</p> <hr/> <p style="text-align: center;">40449</p>  <p style="text-align: center;">3" ARBOR</p> <p style="text-align: center;">1</p> |
|---|---|---|---|

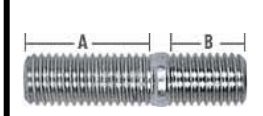

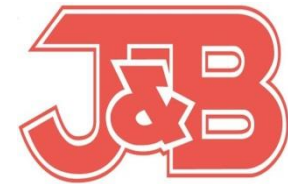
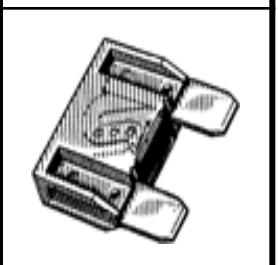
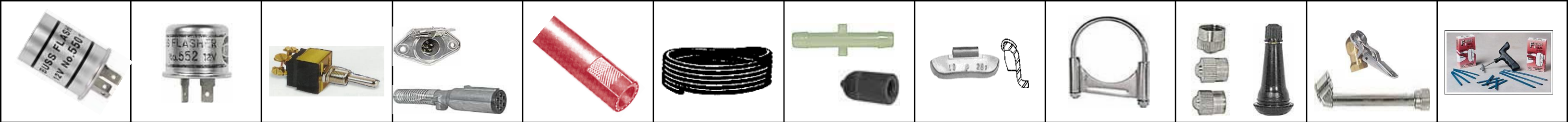

PART# 2855

J&B Fleet - Industrial Supply

22428 Harrisburg-Westville Rd. Alliance, Ohio 44601 Phone: (330) 821-6342 Fax: (330) 821-0411

www.jbfleet.com

BRISTLE DISCS

42163



3" COARSE GREEN

2

40449



3" ARBOR

1

42162



2" COARSE GREEN

3

42160



2" MEDIUM YELLOW

3

42164



2" FINE WHITE

3

40448



2" ARBOR

1



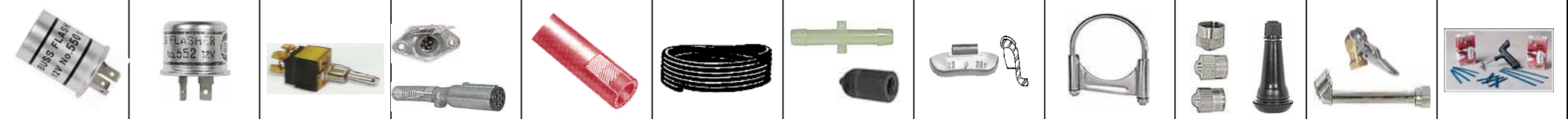





J&B Fleet - Industrial Supply

22428 Harrisburg-Westville Rd. Alliance, Ohio 44601 Phone: (330) 821-6342 Fax: (330) 821-0411

www.jbfleet.com

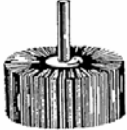
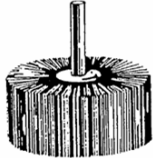
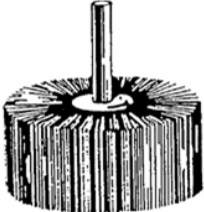
PART # 2202

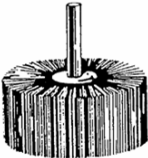
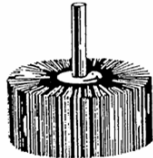
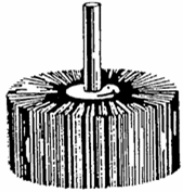
FLAP WHEELS

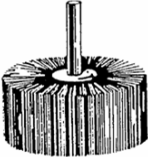
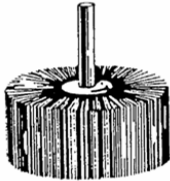
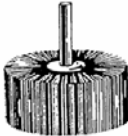
| | | | |
|---|---|---|---|
| <p>40654</p>  <p>1 1" DIA 60 GRIT</p> | <p>42388</p>  <p>1 1-1/2" DIA 80 GRIT</p> | <p>40662</p>  <p>1 2" DIA 120 GRIT</p> | <p>42395</p>  <p>1 3" DIA 60 GRIT</p> |
| <p>40655</p>  <p>1 1" DIA 80 GRIT</p> | <p>42391</p>  <p>1 2" DIA 60 GRIT</p> | <p>40664</p>  <p>1 2" DIA 180 GRIT</p> | <p>42397</p>  <p>1 3" DIA 120 GRIT</p> |
| <p>42385</p>  <p>1 1" DIA 120 GRIT</p> | <p>40660</p>  <p>1 2" DIA 80 GRIT</p> | <p>42393</p>  <p>1 2-1/2" DIA 80 GRIT</p> | |
| <p>42387</p>  <p>1 1-1/2" DIA 60 GRIT</p> | | | |



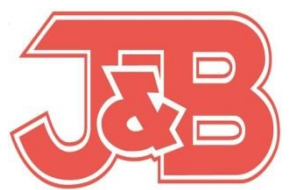
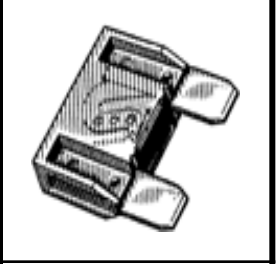
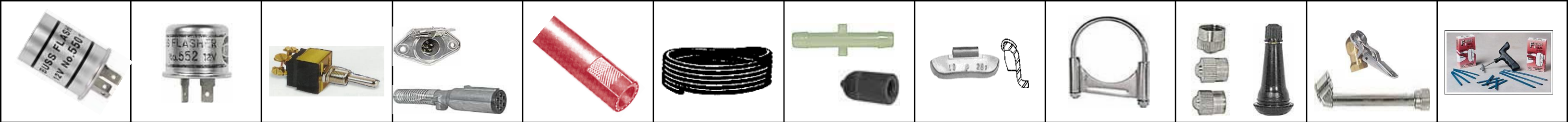

PART# 2856

J&B Fleet - Industrial Supply

22428 Harrisburg-Westville Rd. Alliance, Ohio 44601 Phone: (330) 821-6342 Fax: (330) 821-0411

www.jbfleet.com

MINI FLAP DISCS

59114

2" 40 GRIT

3

59117

3" 40 GRIT

3

59118

3" 80 GRIT

3

59115

2" 80 GRIT

3

40449

3" ARBOR

1

40448

2" ARBOR

1

40448

2" ARBOR

1



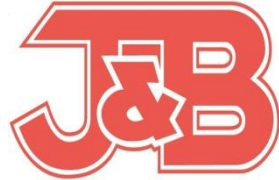
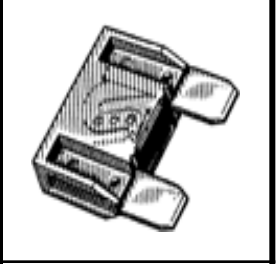





PART# 2857

J&B Fleet - Industrial Supply

22428 Harrisburg-Westville Rd. Alliance, Ohio 44601 Phone: (330) 821-6342 Fax: (330) 821-0411

www.jbfleet.com

TRIM-KUT DISCS

| | | | |
|--|---|---|--|
| <p style="text-align: center;">20441</p>  <p style="text-align: center;">3" 24 GRIT WHITE</p> <p style="text-align: center;">10</p> | <p style="text-align: center;">20442</p>  <p style="text-align: center;">3" 36 GRIT RED</p> <p style="text-align: center;">10</p> | <p style="text-align: center;">20443</p>  <p style="text-align: center;">3" 60 GRIT ORANGE</p> <p style="text-align: center;">10</p> | <p style="text-align: center;">20444</p>  <p style="text-align: center;">3" 120 GRIT GREEN</p> <p style="text-align: center;">10</p> <hr/> <p style="text-align: center;">20450</p>  <p style="text-align: center;">ARBOR</p> <p style="text-align: center;">1</p> |
|--|---|---|--|



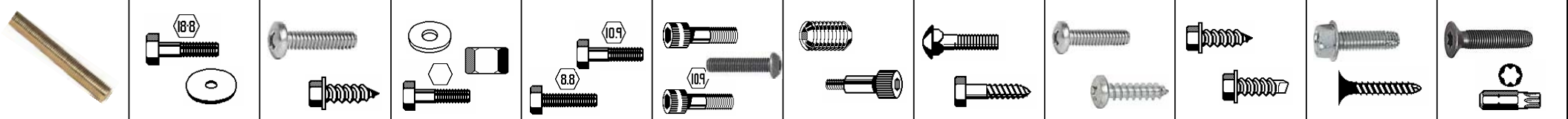







J&B Fleet - Industrial Supply

22428 Harrisburg-Westville Rd. Alliance, Ohio 44601 Phone: (330) 821-6342 Fax: (330) 821-0411

www.jbfleet.com

PART # 2131

ROLON SURFACE DISCS

| | | | |
|--|---|---|---|
| <p>40444 1</p>  <p>3" MEDIUM</p> <p>10</p> | <p>40446 2</p>  <p>3" COARSE</p> <p>10</p> | <p>40440 3</p>  <p>2" MEDIUM</p> <p>10</p> | <p>40442 4</p>  <p>2" COARSE</p> <p>10</p> |
| <p>Non-woven surface conditioning discs are ideal for deburring, cleaning, blending, and polishing. Use on mild steel, stainless, aluminum, plastic or wood.</p> | | <p>40448 5</p>  <p>2" ARBOR</p> <p>1</p> | <p>40449 6</p>  <p>3" ARBOR</p> <p>1</p> |

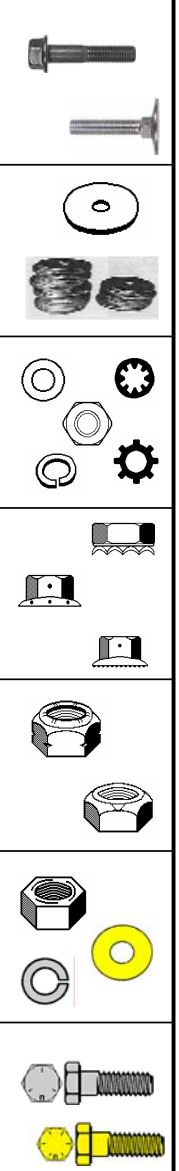













J&B Fleet - Industrial Supply

www.jbfleet.com

22428 Harrisburg-Westville Rd. Alliance, Ohio 44601 Phone: (330) 821-6342 Fax: (330) 821-0411

PART # 2204

ROL-ON SANDING DISCS

| | | |
|--|--|---|
| <p>1</p> <p>41952</p>  <p>5</p> <p>2" 120 GRIT 3M</p> | <p>2</p> <p>41950</p>  <p>5</p> <p>2" 36 GRIT 3M</p> | <p>3</p> <p>38966</p>  <p>3</p> <p>3" 80 GRIT</p> |
| <p>4</p> <p>41981</p>  <p>5</p> <p>2" 80 GRIT 3M</p> | <p>5</p> <p>41979</p>  <p>3</p> <p>2" 24 GRIT 3M</p> | <p>6</p> <p>38896</p>  <p>3</p> <p>3" 50 GRIT</p> |
| <p>7</p> <p>41980</p>  <p>5</p> <p>2" 50 GRIT 3M</p> | <p>8</p> <p>41979</p>  <p>3</p> <p>2" 24 GRIT 3M</p> | <p>9</p> <p>38897</p>  <p>3</p> <p>3" 36 GRIT</p> |
| <p>10</p> | <p>11</p> | <p>12</p> <p>38898</p>  <p>3</p> <p>3" 24 GRIT</p> |



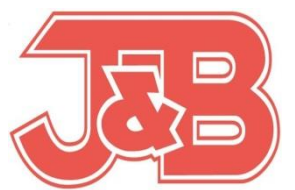

PART# 2858

J&B Fleet - Industrial Supply

22428 Harrisburg-Westville Rd. Alliance, Ohio 44601 Phone: (330) 821-6342 Fax: (330) 821-0411

www.jbfleet.com

2" ROLON DISCS

| | | | |
|---|--|--|---|
| <p style="text-align: center;">38899</p>  <p style="text-align: center;">2" FINE BLUE</p> <p style="text-align: center;">10</p> | <p style="text-align: center;">40440</p>  <p style="text-align: center;">2" MEDIUM MAROON</p> <p style="text-align: center;">10</p> | <p style="text-align: center;">40442</p>  <p style="text-align: center;">2" COARSE BROWN</p> <p style="text-align: center;">10</p> | <p style="text-align: center;">40448</p>  <p style="text-align: center;">2" ARBOR</p> <p style="text-align: center;">1</p> |
|---|--|--|---|



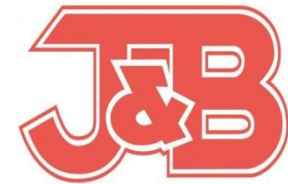
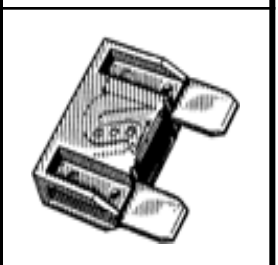

PART# 2859

J&B Fleet - Industrial Supply

22428 Harrisburg-Westville Rd. Alliance, Ohio 44601 Phone: (330) 821-6342 Fax: (330) 821-0411

www.jbfleet.com

3" ROLON DISCS

38900



**3"
FINE
BLUE**

10

40444



**3"
MEDIUM
MAROON**

10

40446



**3"
COARSE
BROWN**

10

40449



3" ARBOR

1



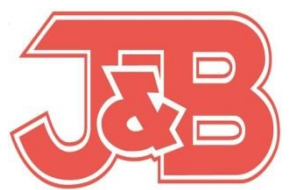
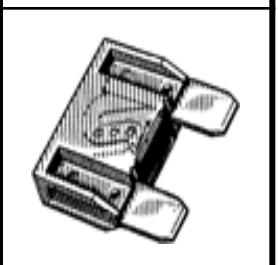
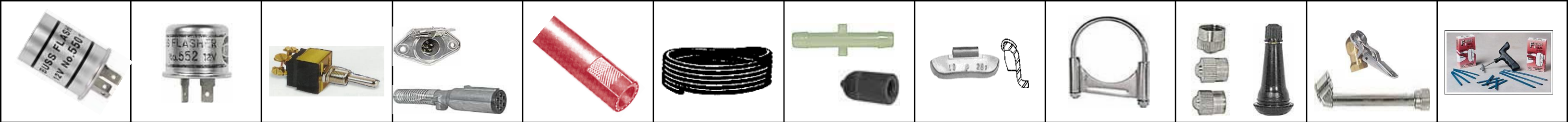

PART# 2861

J&B Fleet - Industrial Supply

22428 Harrisburg-Westville Rd. Alliance, Ohio 44601 Phone: (330) 821-6342 Fax: (330) 821-0411

www.jbfleet.com

2" ROLON DISCS

| | | | |
|--|---|---|---|
| <p style="text-align: center;">41988</p>  <p style="text-align: center;">2" FINE BLUE</p> <p style="text-align: center;">10</p> | <p style="text-align: center;">41893</p>  <p style="text-align: center;">2" MEDIUM MAROON</p> <p style="text-align: center;">10</p> | <p style="text-align: center;">41895</p>  <p style="text-align: center;">2" COARSE BROWN</p> <p style="text-align: center;">10</p> | <p style="text-align: center;">40448</p>  <p style="text-align: center;">2" ARBOR</p> <p style="text-align: center;">1</p> |
|--|---|---|---|



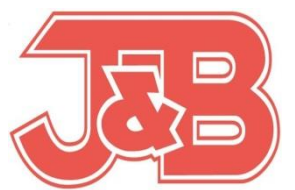

PART# 2863

J&B Fleet - Industrial Supply

22428 Harrisburg-Westville Rd. Alliance, Ohio 44601 Phone: (330) 821-6342 Fax: (330) 821-0411

www.jbfleet.com

3" ROLON DISCS

| | | | |
|---|--|--|---|
| <p style="text-align: center;">41932</p>  <p style="text-align: center;">3" FINE BLUE</p> <p style="text-align: center;">10</p> | <p style="text-align: center;">41897</p>  <p style="text-align: center;">3" MEDIUM MAROON</p> <p style="text-align: center;">10</p> | <p style="text-align: center;">41898</p>  <p style="text-align: center;">3" COARSE BROWN</p> <p style="text-align: center;">10</p> | <p style="text-align: center;">40449</p>  <p style="text-align: center;">3" ARBOR</p> <p style="text-align: center;">1</p> |
|---|--|--|---|

















J&B Fleet - Industrial Supply

22428 Harrisburg-Westville Rd. Alliance, Ohio 44601 Phone: (330) 821-6342 Fax: (330) 821-0411

www.jbfleet.com

PART # 2139

MOUNTED STONES

| | | |
|--|--|--|
| <p>1</p> <p>40690</p>  <p>2</p> <p>IND # W235</p> <p>1</p> | <p>3</p> <p>40682</p>  <p>4</p> <p>IND # A21</p> <p>1</p> | <p>5</p> <p>40680</p>  <p>6</p> <p>IND # A3</p> <p>1</p> |
| <p>7</p> <p>40683</p>  <p>1</p> <p>IND # A31</p> | <p>8</p> <p>40684</p>  <p>9</p> <p>IND # A36</p> <p>1</p> | <p>10</p> <p>40685</p>  <p>11</p> <p>IND # B52</p> <p>1</p> |
| <p>13</p> <p>40686</p>  <p>14</p> <p>IND # W163</p> <p>1</p> | <p>15</p> <p>40687</p>  <p>16</p> <p>IND # W185</p> <p>1</p> | <p>17</p> <p>40681</p>  <p>18</p> <p>IND # A11</p> <p>1</p> |
| <p>19</p> <p>40688</p>  <p>20</p> <p>IND # W215</p> <p>1</p> | <p>21</p> <p>40689</p>  <p>22</p> <p>IND # W220</p> <p>1</p> | <p>23</p> <p>40691</p>  <p>24</p> <p>IND # W236</p> <p>1</p> |



