

**CASE IH ROTOR BAR PARTS / KITS**

PART#	TO FIT:	PRICE EA.
<b>A-B93417</b> 12 Helical/9 Straight	1440, 1460, 1640, 1660, 1666, 2166, 2366	\$ 565.00
<b>A-B93419</b> 12 Helical/3 Straight	STANDARD ROTOR	\$ 370.00
<b>WN-1309336C2</b> (STANDARD HARDENED)	Rasp bars should normally be replaced when serrations are worn down approximately 3/16".	\$ 14.50 SALE
<b>WN-84164540</b> (Speciality Rotor-EXTENDED WEAR)	1640, 1660, 1666, 1680, 1688, 2166, 2188, 2366, 2388, 2577, 2588, 5088, 6088, 7010, 7088, 7120, 8010, 8120, 9120, 5130-7130, 7230, 5140-7140, 7240,-9240	\$ 22.95 SALE
<b>WN-1309175C3</b> (EXTENDED WEAR) (Specialty Rotor Segment W/ Spike)	IMPROVES FLOW OF MATERIAL THRU MACHINE	\$ 23.00 SALE
<b>WN-1318976C2</b> REAR STRAIGHT KICKER BAR	1640, 1660, 1666, 1680, 1688, 2166, 2188, 2366, 2388, 2577, 2588, 5088, 6088, 7010, 7088, 8010	\$ 55.00
<b>WN-1327676C1</b> REAR HELICAL KICKER BAR	AFX	\$ 62.50

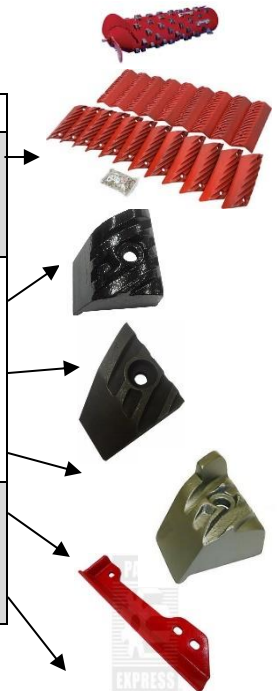

MODEL # / PART # → ↓	A-1309336C2 / WN-278821A2 STANDARD ROTOR SEGMENT	WN-1318976C1 STRAIGHT KICKER	WN-1327676C1 HELICAL KICKER
1660-1666	48 PCS. (SPECIALTY)	8 PCS.	3 PCS.
2366-2388	62 PCS. (AFX)	8 PCS.	2 PCS.
5088-5140, 6088-6140, 7088	58 PCS.	8 PCS.	2 PCS.
7230-8240	64 PCS. + 8 SPIKE SEG.	4 PCS.	2 PCS.



**WEARBARS (CHROME)**



PART #	DESCRIPTION	TO FIT C-IH	PRICE EA.
B94525	3 Bar Set w/Hardware	1420-40-60, 1620-40-60, 1688,2366	\$ 292.00
B94527	2 Bar Set w/Hardware	1480, 1680, 2188, 2388	\$ 225.00
B93732	Blade Impeller Chrome Bar Set	1480, 1680, 2188, 2388	\$ 565.00

**IMPELLER BLADE KIT**

PART #	MODELS	PRICE EA.
B93730	1440-60, 1640-66, 2166-2366	\$ 839.00
B93731	(CHROME)	\$ 1295.00
434525A3	2377-88, 2577-88 (AFX), 5088-7088	\$ 595.00

**CASE IH FEEDER HOUSE CHAINS AND SLATS**

PART #	FEEDER LENGTH	# OF LINKS	MODEL TO FIT C-IH	SLAT #	PRICE EA.
117869A1	47"	60 (557)	(1420,1440,1460,1620,1640,1644,1660,1666)	10	\$ 555.00
WN-117871A1-S	54"	69 (557)	(1440,1460,1640,1660,1666,2144,2166,2366)	12 SERRATED	\$ 625.00
WN-117872A1-S	54"	69 (557)	(1480,1680,1688,2188)	12 SERRATED	\$ 605.00
WN-84207190	54"	69 (557)	(1680,1688,2188,2388 <b>3-STRAND</b> ) ( <b>195666A2</b> )	22 SERRATED	\$ 795.00
AM-47596677		5130, 5150, 6130, 6150, 7130, 7150, 5140-7140 (SN YFG 14001>)		22 SLATS	\$ 955 SALE
WN-136438A1	60"	76 (557)	(2144,2166,2344,2366)	10 SERRATED	\$ 575.00
WN-84179639	60"	N/A (557)	(7120, 7230, 7240, 8120, 8230, 8240, 9120, 9230 W/ TRAP, 9240)	36 SERRATED	\$ 1195 SALE
WN-87283356	60"	N/A (557)	AFX 7010/8010 SER. # <HAJ106756 (2 REQUIRED)	12	\$ 650.00
118268A1	SLAT	N/A	(1644,1666,2144,2166,2344,2366)	N/A	\$ 27.00
118269A1	SLAT	N/A	(1680,1688,2188)	N/A	\$ 33.50
118270A1	SLAT	N/A	(1640,1660,1666 SERRATED)	N/A	\$ 35.50
196357A1	SLAT	N/A	(2188,2388 SMOOTH RIGHT HAND)	23.38"	\$ 21.50
196358A1	SLAT	N/A	(2188,2388 SMOOTH LEFT HAND)	N/A	\$ 21.50
196359A2	SLAT	N/A	(2188,2377,2388,2577,2588 SERRATED RH)	54"&60" CHAINS	\$ 28.50
196360A3	SLAT	N/A	(2188,2377,2388,2577,2588 SERRATED LH)	N/A	\$ 34.50



Please Call For Availability.  
PRICES SUBJECT TO CHANGE WITHOUT NOTICE!



### CASE IH REPLACEMENT CONCAVES

PART #	DESCRIPTION	MODEL	PRICE EA.
1302606C5	FRONT	1440, 1460, 1640, 1660, 1666, 2144, 2166, 2366 HD	\$ 610.00
1302607C4	MIDDLE/REAR	1440, 1460, 1640, 1660, 1666, 2144, 2166, 2366 HD	\$ 595.00
B93572	SET OF 3	1440, 1460 (NON-STOCK) HD	\$ 1600 SALE
B96128	SET OF 3	1640, 1660, 1666, 2144, 2166, 2366 HD	\$ 1680 SALE
B96125	SET OF 3	1680, 1688, 2188, 2577, 2588, 5088, 6088, 7088	\$ 1760 SALE
193782C6	FRONT HD	1480, 1680, 2388 (SN <JJC0276540)	\$ 780 SALE
193783C5	MIDDLE/REAR HD	1480, 1680, 2388 (SN <JJC0276540)	\$ 630 SALE
A-386189A1	MIDDLE/REAR	1680, 1688, 2188, 2377, 2388, 2577, 2588, 5088, 5130, 5140, 6088, 6130, 6140, 7088, 7130, 7140	\$ 755 SALE
A-47607204	F/M/R LARGE WIRE	5140, 5150, 6140, 6150, 7140, 7150, (1/2 WIDTH)	\$ 425 SALE
716-063	THRESH START	(KX7) 1680, 1688, 2188, 2377, 2388, 2577, 2588, 5088, 5130, 5140, 6088, 6130, 6140, 7088, 7130, 7140	\$ 1850 SALE
716-043	SET OF 6	(KX7) 1680, 1688, 2188, 2377, 2388, 2577, 2588, 5088, 5130, 5140, 6088, 6130, 6140, 7088, 6150, 7130-50	\$ 5550 SALE
716-060	THRESH START	KX7 7010AFX, 7120, 7240, 8010, 8120, 8230, 9120, 9230	\$ 2495 SALE
716-048	SET OF 8	KX7 7010AFX, 7120, 7240, 8010, 8120, 8230, 9120, 9230	\$ 5000 SALE

### CASE IH ELEVATOR CHAINS AND SPROCKETS

PART #	DESCRIPTION	MODEL	PRICE EA.
A-1302201C91	CLEAN GRAIN CHAIN	1440, 1460	\$ 439 SALE
WN-1321334C92	CLEAN GRAIN CHAIN	1640, 1660, 1666, 2144, 2166, 2366	\$ 325 SALE
WN-1317482C92	CLEAN GRAIN CHAIN	1680, 1688, 2188, 2377, 2388, 2588	\$ 339 SALE
WN-87281911	CLEAN GRAIN CHAIN	7010, 7120-50, 8120-50, 9120-50	\$ 495 SALE
WN-1303114C91	RETURN GRAIN CHAIN	1420-2388, 5088, 6088, 7088	\$ 219 SALE
WN-1317192C1	UPPER/LOWER CLEAN GRAIN SPROCKET	1640-2388	\$ 56.50
WN-168683C1	CLEAN GRAIN/TAILINGS SPROCKET	1420-2388	\$ 44.95
WN1317250C91	BEARING CLEAN GRAIN SHAFT	1640-2588	\$ 39.00
WN-87283438	UPPER CLEAN GRAIN SPROCKET	7010-9240 SERIES	\$ 82.00
WN-87283436	LOWER CLEAN GRAIN SPROCKET	7120-9230 SERIES	\$ 76.00
A-1318585C3	OUTER CLEAN GRAIN BOOT	1640-2366 W/OUT YIELD MONITOR	\$ 78.50
A-1317673C2	INNER CLEAN GRAIN BOOT	1640, 1660, 1666, 2144, 2166, 2366	\$ 86.00
A-1318584C2	INNER CLEAN GRAIN BOOT	1680, 1688, 2188, 2388, 2577, 2588	\$ 105.00
A-191771C1	TAILING ELEVATOR BOOT	1420, 1440, 1460, 1620, 1640, 1660, 1666	\$ 255.00
A-183160C1	TAILING ELEVATOR BOOT	1480, 1680, 1688, 2144, 2166, 2188	\$ 319.00
WN-87598258	AUGER ELBOW	1420-2588	\$ 609.00
WN-192475C3	LOWER UNLOADING SUMP W/DOOR	1420-2588	\$ 855 SALE
A-223237A1	OUTER SIDE PLATE	66-88 SERIES WITH AFS	\$ 72.95

### ADJUSTABLE SIEVES TO FIT CASE IH COMBINES

PART #	LOCATION	MODELS	FINGER STYLE	DIMENSIONS	PRICE EA.
WN-1330686C2	TOP	1440, 1460, 1640, 1660	LONG (1-5/8")	45" X 61.75"	\$ 585 SALE
WN-1346914C2	BOTTOM		BLUNT/SHORT	45" X 51.5"	\$ 595 SALE
WN-1957314C7	TOP	1640, 1660, 1666, 2144, 2166, 2344, 2366	LONG (1-5/8")	45" X 75"	\$ 785 SALE
WN-1994961C5	BOTTOM	(EXTENDED CLEANING)	SHORT (1-1/8")	45" X 65"	\$ 635 SALE
WN-87710706	TOP	1680, 1688, 2188, 2388, 2377, 2577, 2588, 5088, 5130-40, 6088, 6130-50, 7088, 7130-50	LONG (1-5/8")	60" X 75"	\$ 935 SALE
WN-1322464C6	BOTTOM	1680-88, 2188-2588, 6088-7088	SHORT (1-1/8")	60" X 65"	\$ 935 SALE
A-1330323C2	SIEVE	1640, 1660, 1666, 1680, 2144-2588	BUSHING CHAFFER DRIVE ARM	5/8"X1-1/2"X2.89"	\$ 20.50
A-87538600		1688, 2166, 2188, 2366,	BUSHING	10 REQUIRED	\$ 17.00
A-87376924		2377, 2388, 2577, 2588	CHAFFER FRAME	2 REQUIRED	\$ 25.00
A-87299946	KIT (FULL SET)	FOR CHAFFER FRAME	BUSHINGS	1 REQUIRED	\$ 485.00

Long Finger

Short Finger

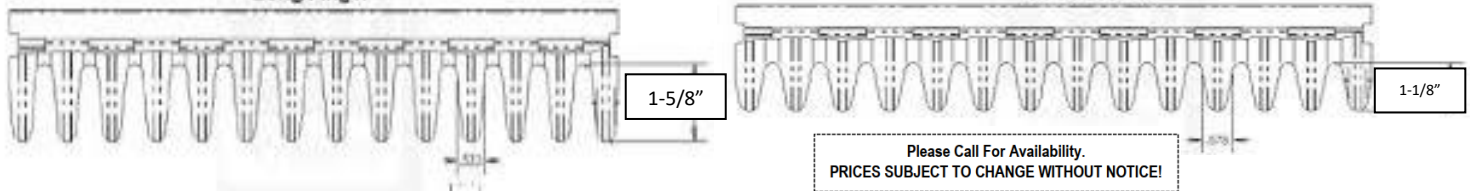

## STRAW CHOPPER PARTS TO FIT CASE IH 14XX-25XX

PART #	MODEL	DESCRIPTION	PRICE EA.
WN-442832A1 A-B96349	1420-2588, 5088-7088, 5130-7130, 5140-7140 <b>(24 OR 28 PIECES PER CHOPPER)</b>	STD 2 PC. KNIFE SET TUNGSTEN 2 PC SET	\$ 20.95 SALE \$ 50.00 SALE
1302763C1	1440-2388 (12 REQUIRED)	CONCAVE CHOPPER KNIFE DOUBLE	\$ 11.95
1302764C1	1440-2388 (1 REQUIRED)	CONCAVE CHOPPER KNIFE SINGLE	\$ 11.95
87315088	2377-7088	CHOPPER KNIFE DOUBLE	\$ 17.95
87315495	1440-2588	STRAW CHOPPER BAR W/ KNIVES	\$ 409 SALE
K11081	7010, 8010, 8120, 9120, 7230, 8230, 9230	<b>STRAW CLAW KNIFE SET OF 2</b>	\$ 86 SALE
K11080	1460-2588, 5088, 5130-40, 6088, 6130-40,7088, 7130-40	<b>STRAW CLAW KNIFE SET OF 2</b>	\$ 59 SALE

## LED LIGHT CONVERSION KITS TO FIT CASE IH COMBINES

PART #	MODELS	DESCRIPTION	PRICE EA.
WL2123KT	2144, 2166, 2188, 2366, 2377, 2388, 2577, 2588	Replacement lights for all front headlights located at top of the cab, 4 – A-WL1295 outer with high beam and 2 – A-WL1300 center with hi/lo beam. Direct fit, plugs into existing machine wiring harness	\$ 630.00
WL789KT	5088-9230	Replacement for the front headlights located at top of the cab (4) A-WL1365 outer cab, (2) A-WL1370 center cab and (2) A- WL1240 stubble lights).	\$ 1075.00

## BELT DIGRAM FOR CASE IH 14XX-25XX COMBINES

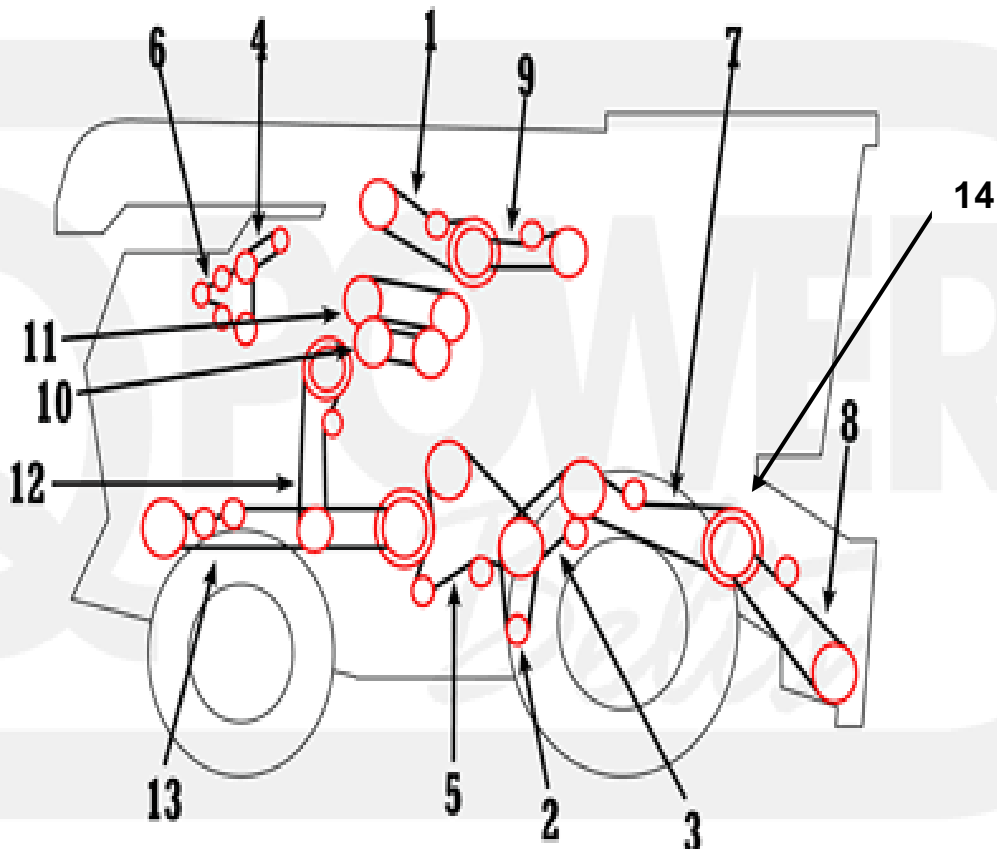

Please Call For Availability.  
PRICES SUBJECT TO CHANGE WITHOUT NOTICE!

**BELTS TO FIT CASE IH 16XX-25XX COMBINES**

#	PART #	DESCRIPTION	MODELS	PRICE EA.
1	1970115C1		1640, 1660 (SN <JJC0102897)	\$ 43.95
	191288C2		1660 (W/IH ENGINE), 1680 (SN <JJC0045689)	\$ 50.95
	1347387C1		1640 (SN JJC0097103>), 1660 (SN JJC0102897> W/OUT C FLOW CLEANING SYSTEM), 1644	\$ 83.95
	1541699C1	AUXILIARY PUMP DRIVE	1660 (SN JJC0103800> W/CROSS FLOW CLEANING SYSTEM), 1666	\$ 64.00
	1541700C1		1688, 2144, 2344	\$ 82.00
	124572A1		2166, 2366	\$ 86.00
	124573A1		2188, 2388 (SN <JJC0272999)	\$ 78.00
	440498A3		2388 (SN JJC0273000>) 2388 (SN HAJ292001>) 2377, 2577, 2588	\$ 104.00
2	195396C2		1640, 1660 (W/OUT EXT CLEANING SYSTEM), 1680	\$ 62.00
	1541569C1	CLEANING FAN DRIVE	1660 (W/EXT CLEANING SYSTEM), 1644, 1666, 1688, 2144, 2166, 2188, 2344, 2366 (SN <JJC0184544), 2388 (SN <JJC0198068)	\$ 68.50
	301146A1		2366 (SN JJC0184544>), 2388 (SN JJC0198068>), 2377, 2388 (SN HAJ292001>), 2577, 2588	\$ 48.95
3	191305C1		1640, 1660, 1644, 1666, 2144, 2166, 2344, 2366 (SN <JJC0184544)	\$ 64.00
	181359C1		1440, 1460, 1480, 1640, 1660 (67" BELT)	\$ 56.00
	317904A1	FAN JACKSHAFT DRIVE	1680, 1688, 2188, 2388 (SN <JJC0198068)	\$ 81.50
	301111A1	(84448591)	2166, 2366 (SN JJC0184544>)	\$ 55.00
	317904A1		1480, 1680, 1688, 2188, 2377, 2388 (SN JJC0198068>), 2388 (SN HAJ292001>), 2577, 2588,	\$ 82.00
4	164550R2		1640 (SN <JJC0034705), 1660 (SN <JJC0038346), 2344	\$ 17.00
	396829R1		1640(SNJJC0034705>), 1660(SNJJC0038346>), 1666,	\$ 17.00
	1250587C1	A/C COMPRESSOR	1688, 2166, 2188, 2366 (SN <JJC0255699), 2388 (SN <JJC0272999)	\$ 14.00
	235414A1		1680, 1644, 2144	\$ 19.00
	87311867		2366 (SN JJC0255700>), 2388 (SN JJC0273000>), 2388 (SN HAJ292001-HAJ3000000), 2377	\$ 19.00
			2388 (SN HAJ30001>), 2577, 2588	\$ 19.00
5	181055C1	ELEVATOR DRIVE (W/ CHOPPER)	1440, 1460, 1480, 1640, 1660, 1680,1644, 1666, 2144, 2166, 2188, 2344, 2366, 2388, 2577, 2588	\$ 169.00
	186509C2	ELEVATOR DRIVE (W/ BEATER)	1640, 1660, 1680,1644, 1666, 2144, 2166, 2188, 2344, 2366, 2388, 2577, 2588	\$ 212.00
6	537072R92		1640 (SN <JJC0034705), 1660 (SN <JJC0038346), 1680 (SN <JJC0045689),	\$ 58.00
	J911572		1660 (SN JJC0038346>) W/ CR FLOW CLEANING SYSTEM, 1666,1688,2166,2188	\$ 28.00
	J911574	ENGINE FAN & ALT.	1640 (SN JJC0034705>), 1660 (SN JJC0038346> W/CFCS),1680 (SN JJC0045689>)	\$ 39.00
	J911565		1644, 2144, 2344	\$ 39.00
	A77938		2366 (SN <JJC0255700), 2388 (SN <JJC0273000),	\$ 32.00
	A780-K8		2366 (SN JJC0255700>), 2388 (SN JJC0273000>), 2377, 2388 (SN HAJ292001>), 2577, 2588	\$ 33.00
7	192738C1	FEEDER DRIVE W/OUT TRAP	1640, 1660, 1644, 1666, 2144, 2166, 2344, 2366	\$ 220.00
	1315168C1	FEEDER DRIVE W/ TRAP	1640, 1660, 1644, 1666, 2144, 2166, 2344, 2366	\$ 235.00
	194528C2	FEEDER DRIVE W/OUT TRAP	1680, 1688, 2188, 2377, 2388, 2577, 2588	\$ 309.00
	1315074C1	FEEDER DRIVE W/ TRAP	1480, 1680, 1688, 2188, 2377, 2388, 2577, 2588	\$ 269.00
8	1313095C2	FEEDER JACKSHAFT DRIVE (47")	1640, 1660, 1644, 1666,	\$ 175.00
	87629602	FEEDER JACKSHAF DRIVE (54.5")	1640, 1660, 1680, 1644, 1666, 1688, 2144, 2166, 2188, 2344, 2366, 2388 (SN JJC0268800)	\$ 249.00
	393750A1	FEEDER JACKSHAFT DRIVE (60")	1680, 1688, 2144, 2166, 2188, 2344, 2366, 2388 (SN <JJC0268800)	\$ 329.00
	402370A1	FEEDER JACKSHAF DRIVE (54.5")	2388 (SN JJC0268800>), 2388 (SN HAJ292001>), 2377, 2577, 2588	\$ 265.00
	402368A1	FEEDER JACKSHAFT DRIVE (60")	2388 (SN JJC0268800>), 2388 (SN HAJ292001>), 2377, 2577, 2588	\$ 262.00
9	191290C1		1440, 1460, 1640, 1660 (SN <JJC0102897), 2144, 2166, 2344, 2366	\$ 80.00
	1989216C1	GRAIN TANK UNLOADER DRIVE	1640 (SN 97103>), 1660 (SN JJC0102897>), 1644, 1666,	\$ 89.00
	1989217C1		1680 (SN JJC0115352>), 1688, 2188, 2377, 2388, 2577, 2588	\$ 96.00
10	244420A4		1440, 1460, 1640, 1660, 1644, 1666, 2144, 2166, 2344, 2366	\$ 330.00
	244423A5		1680, 2388 (SN <JJC0273000)	\$ 399.00
	244422A4	ROTOR DRIVE (HD)	1480, 1680, 1688, 2188	\$ 325.00
	413159A1		2377, 2388 (SN JJC0273000>), 2388 (SN HAJ0273000>), 2577, 2588	\$ 339.00
	84194650		2377, 2388 (SN HAJ0295001>), 2577, 2588	\$ 345.00
11	191241C3		1440, 1460, 1640, 1660, 1666, 2144, 2166,2344, 2366	\$ 279.00
	191244C1		1480, 1680 (SN <JJC0045689)	\$ 229.00
	1330499C1	SEPARATOR DRIVE	1680 (SN JJC0045689>)	\$ 179.50
	1541702C1		1688, 2188, 2388 (SN <JJC0270500)	\$ 219.00
	400427A1		2377, 2388 (SN JJC0270500>), 2388 (SN HAJ270500>), 2577, 2588	\$ 295.00
12	1315265C1	STRAW CHOPPER DRIVE	1640, 1660, 1644, 1666, 2144, 2166, 2344, 2366	\$ 69.00
	1315266C1		1680, 1688, 2188, 2377, 2388, 2577, 2588	\$ 89.95
13	196371C1		1440, 1460, 1480, 1640, 1660, 1680, 1644, 1666, 1688,	\$ 75.00
	(84172256)	STRAW SPREADER DRIVE	2144, 2166, 2188, 2344, 2366, 2377, 2388, 2577, 2588	\$ 75.00
14	1979606C1	REEL PUMP DRIVE (47")	1640 (SN JJC0034860-JJC0097170), 1660 (SN JJC0039130-JJC0103066)	\$ 35.00
	1330311C1	REEL PUMP DRIVE (54.5")	1640 (SN JJC0034860-JJC0097170), 1660 (SN JJC0039130-JJC0103066), 1680	\$ 32.00
	1321564C1	REEL PUMP DRIVE (47")	1640 (SN <JJC0034860 & JJC0097171>), 1660 (SN JJC0039130 & JJC010367>)	\$ 42.95
	1321565C1	REEL PUMP DRIVE (54.5")	1640 (SN <JJC0034860 & JJC0097171>), 1660 (SN <JJC0039130), 1680	\$ 58.00

DIAGRAM ON PAGE 72

## BELTS TO FIT CNH "88" MID-RANGE COMBINES

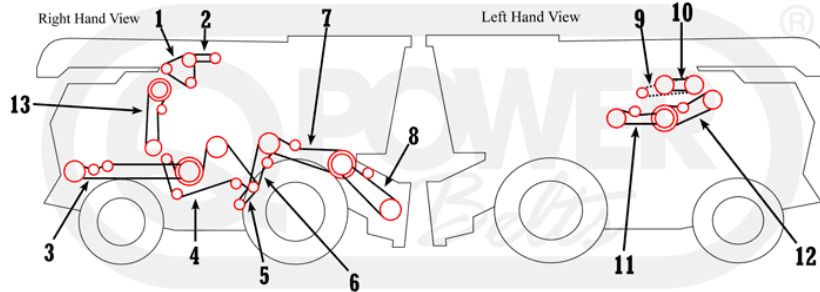

#	PART #	DESCRIPTION	MODELS	PRICE EA.
1	87755884	FAN DRIVE	5088, 6088, 7088	\$ 22.50
2	87311867	A/C COMPRESSOR	5088, 6088, 7088	\$ 19.00
3	84163222	STRAW SPREADER DRIVE (WITH BEATER)	5088-5140, 6088-6140, 7088-7140	\$ 80.00
4	87476487 (186509C2)	CLEANING SYSTEM DRIVE (WITH BEATER)	5088-5140, 6088-6140, 7088-7140	\$ 199.00
	87476486 (181055C1)	CLEANING SYSTEM DRIVE (W/CHOPPER)	5088-5140, 6088-6140, 7088-7140	\$ 170.00
5	301146A1	CLEANING FAN DRIVE	5088-5140, 6088-6140, 7088-7140	\$ 50.00
6	87642957	FAN JACKSHAFT DRIVE	5088, 6088, 7088	\$ 52.00
	301146A1		LOWER 5130, 6130, 7130	\$ 50.00
7	87629601	FEEDER DRIVE (WITH ROCK TRAP)	5088-5150, 6088-6150, 7088-7150	\$ 259.00
	87629602	FEEDER DRIVE (WITH NO ROCK TRAP)	5088, 5150, 6088, 6150, 7088, 7130, 7150	\$ 252.00
8	87332159	HEADER DRIVE (WITH ROCK TRAP)	5088, 5130, 6088, 6130, 7088, 7130	\$ 222.00
	87332161	HEADER DRIVE (WITH NO ROCK TRAP)	5088, 5130, 6088, 6130, 7088, 7130	\$ 229.00
9	84137716	SEPARATOR DRIVE	5088, 6088, 7088	\$ 290.00
	84586129	SEPARATOR DRIVE	5130-50, 6130-50, 7130-50	\$ 478.95
10	84194650	ROTOR DRIVE	5088-5140, 6088-6140, 7088-7140	\$ 339.00
	87615553	ROTOR DRIVE	5130, 6088-6150, 7088-7150	\$ 408.00
11	47424854		5088-5140	\$ 86.00
	87549557	UNLOADER DRIVE	6088-6130, 7088-7140	\$ 175.00
	47360559		5140-50, 6140-50, 7150	\$ 258.95
12	87330894		5088	\$ 98.00
	87549556	AUXILIARY PUMP DRIVE REAR PTO	6088, 7088	\$ 116.00
	84548651		5130-40, 6130-40, 7130-40	\$ 125.00
13	87330903	STRAW CHOPPER DRIVE	5088-5150, 6088-6150, 7088-7150	\$ 83.00

## BELTS TO FIT CNH FLAG SHIP COMBINES "10-40"

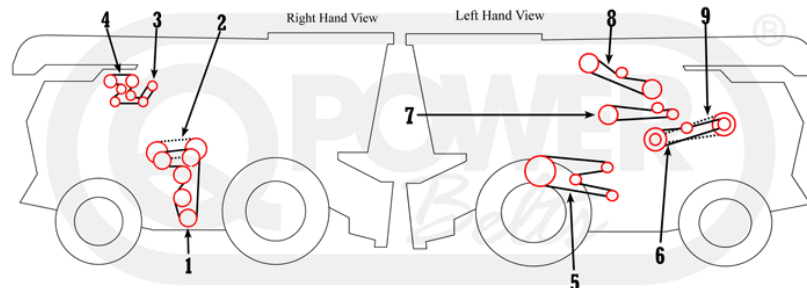

#	PART #	DESCRIPTION	MODELS	PRICE EA.
1	87283139	TAILINGS DRIVE	7010, 8010 (SN HAJ105207>), 7120, 7230, 8120, 8240, 9120, 9230, 9240	\$ 82.95
	87109130		8010 (SN < HAJ105207)	\$110.00
2	86975809	BUBBLE UP DRIVE (RH)	7010, 8010, 7120, 7230, 8120, 8230, 8240, 9120, 9230, 9240	\$ 65.00
3	500371653		7010, 7120	\$ 53.00
	87282305	FAN DRIVE	8010, 8120	\$ 50.00
	504049425		9120	\$ 76.00
4	504212528	A/C, ALTERN, WATER PUMP	7010, 7120, 9120	\$ 24.00
	87282333		8010, 8120, 9120	\$ 44.00
5	87317063	SHOE DRIVE	7010, 8010, 7120, 7230, 8120, 8230, 8240, 9120, 9240	\$ 53.00
6	86517680	BEATER DRIVE	7010, 8010, 7120, 7230, 8120, 8230, 8240, 9120, 9240	\$129.00
7	87011585	UNLOADER DRIVE	7010, 8010, 7120, 8120, 9120	\$105.00
8	86975809	BUBBLE UP DRIVE (LH)	7010, 8010, 7120, 7230, 8120, 8230, 8240, 9120, 9240	\$ 68.00
9	87283315	CHOPPER DRIVE, STRAW (2800 RPM)	7010-8010 (SN <HAJ202001), 7120, 8120, 9120	\$115.00
	86976208	CHOPPER DRIVE, STRAW (3000 RPM)	7010-8010 (SN HAJ202001>), 7120, 8120, 9120	\$131.95

Please Call For Availability.  
PRICES SUBJECT TO CHANGE WITHOUT NOTICE!

## AUGERS TO FIT C-IH 1400-2500 SER. COMBINES

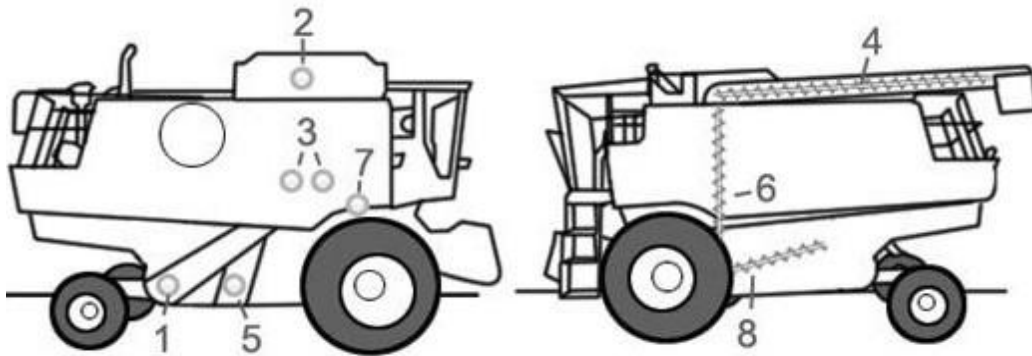

#	PART #	LENGTH	DESCRIPTION	MODEL #	PRICE EA.
1	A-191734C1	62.5"	Lower Tailings	1440, 1460, 1640, 1644, 1660, 1666	\$ 189.00
	GRA100RRB-I	1.00"	BEARING	1440-2366	\$ 14.00
	192549C2	85.250"	Lower Tailings	1480, 1680, 1688	\$ 295.00
	144021A2	62.81"	Lower Tailings	2144, 2166, 2344, 2366	\$ 249.00
2	1319710C1	81.500"	Grain Delivery	1440-60 (* Need Update #1319967C91 OEM PURCHASED )	\$ 315.00
	1318912C3	79.060"	Grain Delivery; 1 1/4" Shaft	1640, 1660, 1666, 2144, 2166, 2366	\$ 395.00
	WN-214490C91		BEARING LH		\$ 37.00
	WN-156011C92		BEARING RH		\$ 17.00
	WN-249275A1	47.375"	INCLINED DELIVERY	1660, 1666, 1688, 2166, 2188, 2366, 2377, 2388, 2577, 2588	\$ 369.00
	WN-320724A3	47.5"	INCLINED DELIVERY STAINLESS	ALL 1600- 2300 AFS	\$ 745.00
	G1106KRRB-I		BEARING		\$ 26.00
	162103C91	11.375"	Grain Delivery (For Corn & Grain)	1420, 1440, 1460, 1480, 1620, 1640, 1660, 1666, 2144, 2166, 2366 (SN <JJ0252949) 815, 915	\$ 119.00
3	A-87617556	110.375"	Grain Tank Bottom OLD# 192784C2	1440, 1460, 1480, 1640, 1660, 1666, 1680, 1688, 2144, 2166, 2188, 2366, 2388	\$ 589.00
	204807C91		BEARING		\$ 12.00
*4	1347499C2	182.875"	UNLOADING *	1640 SN JJC0097103>, 1660 SN JJC0102897>, 1666, 1680 SN JJC0115352>, 1688	\$1230 SALE
	GRA100RRB-I		BEARING		\$ 14.00
	1317935C1	182.125"	Unloading (PIN STYLE) *	1460, 1470, 1480, 1640 SN <-JJC0097103, 1660 SN <-JJC0102897, 1680 SN <-JJC0115352,	\$1060 SALE
	GRA100RRB-I		BEARING		\$ 14.00
	WN-1317680C2	89.250"	Unloading, Rear Split, 172" * (14.3')	1640, 1660 SN JJC0038346>, 1666, 1680, 1688, 2144, 2166, 2188, 2366, 2388	\$ 399.00
	WN-198987A1	90.500"	Unloading, Front Split, 172/208" * (282176A2)	1660, 1666, 1680, 1688, 2144, 2166, 2188, 2366, 2377, 2388, 2577, 2588	\$ 650.00
	WN-199023A1	125.250"	Unloading, Rear Split, 208" (17.3') *		\$ 605.00
	GRA100RRB-I		BEARING	1660, 1666, 1680, 1688, 2166, 2366, 2188, 2388	\$ 14.00
	1317891C1	96.187"	Unloading, Front Split 172" *	1660 (SN<JJC002897), 1680 (SN<JJC0115352)	\$ 695.00
	206KRRB6-I		BEARING		\$ 17.00
5	1319169C1	70.310"	Clean Grain Auger	1440, 1460	\$ 269.00
	WN-1317484C2	68.750"	Clean Grain Auger	1640, 1660, 1666, 1670, 2144, 2166, 2344, 2366	\$ 205.00
	WN-1317250C91		BEARING (LH)		\$ 39.00
	WN-156011C92		BEARING (RH)		\$ 15.00
	WN-1317409C1	76.000"	Clean Grain Auger	1680, 1688	\$ 275.00
	WN-87653248	76.375"	(143959A2)	2188, 2388	\$ 269.00
6	WN-192835C1	49.125"	Vertical Unloading	1440, 1460, 1480, 1640 SN <-JJC0097103, 1660 SN <-JJC0102897, 1680 SN <-JJC0115352	STD \$ 420.00 HD \$ 565.00
	WN-1347389C1 87325666	49.750"	Vertical Unloading	1640, 1666, 1688, 2166, 2188, 2577, 2588 2366, 2388, 1640 SN JJC0097103->, 1660 SN JJC0102897->, 1680 SN JJC0115352->	STD \$ 430.00 HD \$ 599.00
7	A-87379140	37.625"	Tailings Delivery (192563C1)	1480, 1680, 1688, 2188, 2388, 2588	\$ 189.00
	A-193225C1	25.625"	Tailings Delivery	1440, 1460, 1640, 1660, 1666, 2144, 2166, 2366	\$ 180.00
	GRA100RRB-I		BEARING		\$ 14.00
8	WN-1308541C1	78.250"	RH Grain Bed 7/8" Hex Shaft	1420, 1440, 1460, 1480, 1620, 1640, 1660, 1666, 1680, 1688,	\$ 165.00
	WN-1309229C1	78.25"	LH GRAIN BED AUGER	2144, 2166, 2188, 2366, 2388	\$ 165.00
	205KRRB2-I		BEARING		\$ 13.00
	193398C1	78.250"	1.125" Hex Shaft	1640, 1660, 1680, 2166, 2188, 2366, 2388	\$ 225.00

**\*NON-STOCK ITEM!**

Please Call For Availability.  
PRICES SUBJECT TO CHANGE WITHOUT NOTICE!

## AUGERS TO FIT C-IH 5XXX-7140 / NH CR SERIES MACHINES

#	PART #	LENGTH	DESCRIPTION	MODEL	PRICE EA.
1	A-144028A2	85.69"	LOWER TAILINGS AUGER	5088, 5130, 5140 (SN <YFG014000), 6088, 6130, 6140 (SN <YFG014000), 7088, 7130, 7140 (SN <YFG014000)/ NH	\$ 279
	84330031		BEARING		\$ 18.00
2	WN-87379140	37.625"	UPPER TAILINGS AUGER	5088, 5130, 5140 (SN <YFG014000), 6088, 6130, 6140 (SN <YFG014000), 7088, 7130, 7140 (SN <YFG014000)	\$ 165
	574940R91		BEARING	5088, 5140, 6088	\$ 12.00
3	A-87510720	86.375"	CLEAN GRAIN AUGER	5088,5140(SN <YFG014000),6088,6140 (SN <YFG014000),7088,7140 (SN<YFG014000)	\$ 579
	47595610	86.375"		5140 (SN YFG0145001>), 6140 (SN YFG0145001>), 7140 (SN YFG0145001>)	\$ 359 SALE
	RA108RRB-I		BEARING	5088-7140	\$ 27.00
4	WN-87563930	81.5"	STD. TANK FILL AUGER	5088, 5130, 5140(SN <YFG014000),6088, 6130, 6140 (SN <YFG014000),7088, 7130, 7140 (SN<YFG014000)	\$ 495
	WN-84577410	81.5"	EX WEAR TANK FILL	5088, 5130, 6088, 6130, 7088, 7130, 5140, 6140, 7140	\$ 765
	W208KRRB6-I		BEARING	5088, 5130, 6088, 6130, 7088, 7130, 5140, 6140, 7140	\$ 27.95
5	A-87649711	79.06"	FR GRAIN BED AUGER	5088, 5130, 5140, 6088, 6130, 6140, 7088, 7130, 7140	\$ 279.00
	87649712	79.06"	REAR GRAIN BED AUGER		\$ 310
	87650438		BEARING		\$ 17.00
6	87657822	38"	3' UNLOAD AUGER EW	5088, 5140, 6088, 6140, 7088, 7140/ NH CR940, 960, 970, 9040, 9060, 9070	\$ 855
	87280339	212.625"	18' UNLOAD AUGER EW	5088, 5140, 6088, 6140, 7088 / NH CR940, 960, (CR9040-70 SN Y8G112001>)	\$ 1770
	87044350		BEARING		\$ 33.00
7	84447940	47.25"	VERTICAL UNLOAD EW	5088, 5140, 6088, 6140, 7088, 7140/ NH CR940, 960, 970, 9040, 9060, 9070	\$ 879

## AUGERS TO FIT C-IH "FLAGSHIP" 7XXX-9XXX

#	PART #	LENGTH	DESCRIPTION	MODELS	PRICE EA.
1	84402652	97.06"	LOWER TAILINGS AUGER	(EXTENDED WEAR) 7010, 7120, 8010, 8120, 8230, 8240, 9120, 9230, 9240	\$ 585
	87730185	98.25"	LOWER TAILINGS AUGER	(EXTENDED WEAR) 7010, 7120, 8010, 8120, 9120	\$ 545
	GRAE25RRB-1		BEARING	7010, 7120, 9120	\$ 16.00
2	A-87283130	95.375"	CLEAN GRAIN AUGER	(EXTENDED WEAR) 7010, 7120, 8010, 8120, 9120	\$ 749
3	87733272	72.56"	BUBBLE UP AUGER	7010 LOW PROFILE, 7120, 8010 LOW PROFILE, 8120, 9120	\$ 849
	A-87733275	81.625"	BUBBLE UP AUGER	7010, 7120, 7130, 7140, 8010, 8120, 8130, 8140, 9120, 9130, 8240,9240	\$ 739
	AH139296		BEARING	7010, 7120, 7130, 7140, 8010, 8120, 8130, 8140, 9120, 9130, 9140	\$ 29.50
4	WN-87280345	120.8"	FR GRAIN TANK AUGER	(EXTENDED WEAR)	\$ 545
	WN-87280343	120.8"	REAR GRAIN TANK AUGER	7010, 7120, 8010, 8120, 8240, 9120, 9240	\$ 555
	JD10384		BEARING		\$ 33.00
5	87657822	38"	3' UNLOAD AUGER EW		\$ 849
	AH139296	(87605590)	BEARING	7010, 7120, 7140, 8010, 8120, 9120	\$ 29.95
	87280339	212.625"	18' UNLOAD EW		\$ 1775 SALE
	JD10384		BEARING		\$ 33.00
6	WN-87733266	47.25"	VERTICAL UNLOAD AUGER	STD. RATE- 7010, 7120, 8010, 8120, 9120	\$ 899
	WN-87756536	47.25"	VERTICAL UNLOAD AUGER	STD. RATE- 7130, 7140, 7230, 8230, 9230	\$ 895

**EW = EXTENDED WEAR**

**SOME AUGERS ARE NON-STOCK ITEMS!**



Please Call For Availability.  
PRICES SUBJECT TO CHANGE WITHOUT NOTICE!

## CYLINDER BARS TO FIT JD WALKER MACHINES

PART #	MODEL	DESCRIPTION	ROWS OF HOLES	PRICE EA.
V12043	4400	HARDENED	2 ROWS	\$ 570
V12044	6600	HARDENED	2 ROWS	\$ 525
V12045	7700	HARDENED	2 ROWS	\$ 570
V12065	8800	HARDENED	2 ROWS <b>(NON-STOCK)</b>	\$ 675
V12068H	9400-9510	EXTRA HARDENED	1 ROWS	\$ 659
V12072	9600-9610	HARDENED	1 ROW	\$ 855
V12072H	9600-9610	EXTRA HARDENED	1 ROW	\$ 875



**HARDENED = STANDARD**

**EXTRA-HARDENED= HEAT TREATED FOR LONGER WEAR**

ALL BARS ARE BALANCED AND SOLD WITH HARDWARE!

## FEEDER HOUSE CHAINS AND PARTS TO FIT JD WALKER MACHINES

PART #	MODEL	# OF SLATS	CHAIN SIZE	PRICE EA.
AH116712	4400-4420	28	CA550	\$ 660
WN-AH116713	6600-6620	28 (NON-STOCK)	CA550	\$ 595
WN-AH116716	7700-7720	28	CA550	\$ 635
AH207777	9400-9550CTS	34	CA550	\$ 960
WN-AH143399	9600-9650CTS	51	CA550	\$ 1095
H206436	9400-9550 CTS	1 REPLACEMENT SLAT		\$ 23.95
H207776	9600-9650 CTS	1 REPLACEMENT SLAT		\$ 16.95
A-AH125196	9400 (SN:<641500), 9500 (SN:<643900)	SPROCKET SHAFT		\$ 559.00
A-AH125195	9600 (SN:<645300)	SPROCKET SHAFT		\$ 689.00
A-H118583-S	6600-9600	SPLIT FEEDER SPROCKET		\$ 69.00
WN-H118583	6600-9600	FEEDER SPROCKET	CA550	\$ 59.00
WN-AH142394	9400-9550	3 BOLT FEEDER DRUM STANDARD	(52.25")	\$ 655
WN-AH142393	9600-9650 CTS	FEEDER DRUM HD (3 BOLT)	(63.25")	\$ 695



## CONCAVES TO FIT WALKER MACHINES

PART #	MODEL	# OF CROSS BARS	PRICE EA.
AH85396	4400-4420	13 BAR TITAN	\$ 640 SALE
AH113442	6600-6620	13 BAR TITAN	\$ 895 SALE
AH113443	7700-7720	13 BAR TITAN	\$ 1100 SALE
AH150497	9400-9550 CTS	13 BAR (10 SER.)	\$ 1290 SALE
AH150496	9600-9650 CTS	13 BAR (10 SER.)	\$ 1625 SALE

\*OEM Style w/ Wires In First Half.



## CLEAN / RETURN ELEVATOR CHAINS AND PARTS

PART #	MODEL	CHAIN SIZE	DESCRIPTION	PRICE EA.
WN-AH87747	6620, 7700, 7720	CA550	CLEAN GRAIN CHAIN ASSEMBLY	\$ 239
A-AH98032	6620, 7720 (SN 610301>)	CA550	RETURN GRAIN CHAIN ASSEMBLY	\$ 275
WN-AH96388	6600, 6620 (SN<61300), 7700, 7720 (SN<610500)		RETURN GRAIN CHAIN ASSEMBLY	\$ 240
WN-H177988	ALL WALKER MACHINES		UPPER AND LOWER RETURN SPROCKET	\$ 40
WN-AH162441	9400, 9410, 9500, 9510	CA550	CLEAN GRAIN CHAIN ASSEMBLY	\$ 309
WN-AH131074	9400-10, 9500-50, 9560	CA550	RETURN GRAIN CHAIN ASSEMBLY	\$ 275
WN-AH162058	9450, 9550, 9560 CTS, 9660 CTS	CA550	CLEAN GRAIN CHAIN ASSEMBLY	\$ 395
WN-AH162442	9600, 9610	CA550	CLEAN GRAIN CHAIN ASSEMBLY	\$ 350
WN-AH131074	9600-9660 CTS	CA550	RETURN GRAIN CHAIN ASSEMBLY	\$ 270
WN-H133143	9000 SERIES		LOWER CLEAN GRAIN DRIVE SPROCKET	\$ 37
WN-H177988			UPPER CLEAN GRAIN DRIVE SPROCKET	\$ 39
WN-AH149182	9400-9510 (4 BOLT STYLE)		LOWER CLEAN GRAIN ELEVATOR BOOT	\$ 430
WN-AH129357	9400-9510		LOWER CLEAN GRAIN ELEVATOR DOOR	\$ 79
WN-AH149181	9600, 9610		LOWER CLEAN GRAIN ELEVATOR BOOT	\$ 340
WN-AH129358	9600, 9610		LOWER CLEAN GRAIN ELEVATOR DOOR	\$ 77



Please Call For Availability.  
PRICES SUBJECT TO CHANGE WITHOUT NOTICE!



## BELTS AND AUGERS TO FIT JD 20 SERIES COMBINES

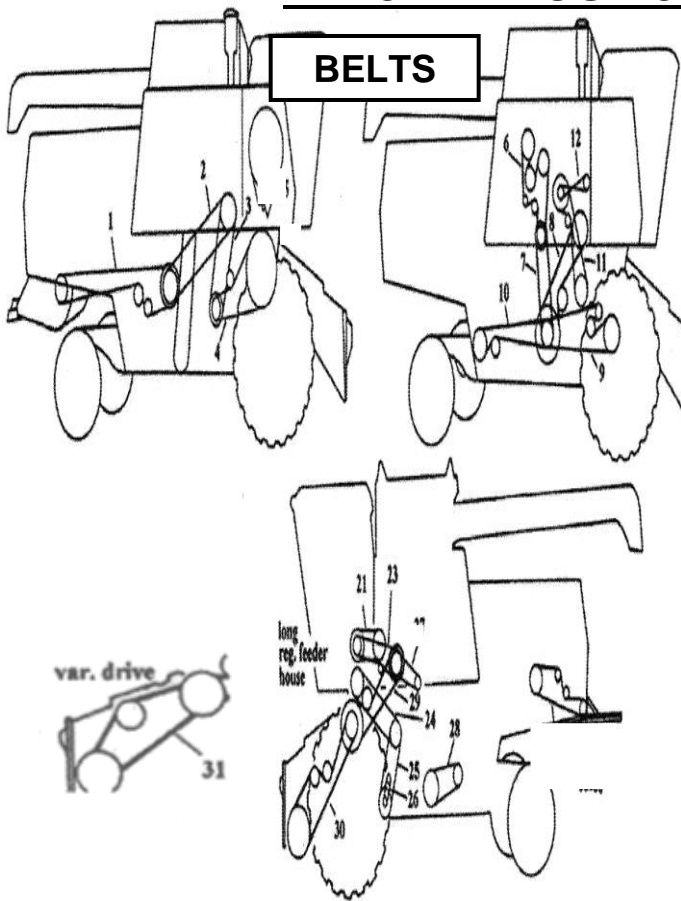

#	PART #	DESCRIPTION	TO FIT MODEL #	PRICE
1	H103344	Rear Straw Chopper 7/8 X 278.25"	6620, 7720, 8820	\$ 85.00
2	H101436	Straw Chopper Drive 7/8 X 136.5	6600, 6620, 7720, 8820	\$ 47.00
3	H113749	Torq-Sensing Countershaft Drive	6600, 6620, 7700, 7720, 8820	\$ 149.00
4	H110375	Cylinder 5/8 X 108"	6620, 7720, 8820	\$ 129.00
4	H96421	Cylinder 5/8 X 100"	6620 SN-600832>, 7720 SN-601301>	\$ 139.00
4	H96423	Cylinder-3 Band 5/8 X 100.8"	6600, 6620 (SN:<551900), 7700, 7720 (SN:<556300)	\$ 99.00
6	H77766	Clean Grain 7/8 X 157.2"	6600, 6620 (SN:502550>), 7700, 7720 (SN:507350>)	\$ 45.00
7	H161339	Torque Sensing 2 X 91.5"	6600, 6620, 7700, 7720	\$ 155.00
8	H81222	SECONDARY COUNTER SHAFT 7/8" X 152.4"	6620 (SN<551900), 7720 (SN<556301)	\$ 46.00
8	H110300	Secondary Counter Shaft 7/8 X 154.5	6620 (SN551900->), 7720 (SN556301->)	\$ 48.00
9	H77010	Shoe Grain Supply Augers 7/8 X 179"	6600, 6620, 7700, 7720, 8820	\$ 54.00
10	N110085	Tailings, Lower Auger .913 X 131.4"	6620, 7700, 7720, 8820,	\$ 61.00
11	H96414	Beater-(100% Beater Speed) 7/8 X 71.5"	6620, 7720, 8820	\$ 26.00
21	AH96300	Unloading Auger Drive (Set of 2) 7/8 X 66.5"	6620, 7720, 8820	\$ 45.00
23	H108175	Multi-Grove Separator Drive 7/8 X 91.81"	6620, 7700 SN 8001->, 7720, 8820	\$ 115.00
29	AMH23927	Feeder House Drive w/Reverser 1 1/4 X 125"	6600, 6620, 7700 SN 8001->, 7720, 8820	\$ 70.00
30	H111519	Regular Lower Feeder House Drive	6620 (SN 502551-615100) 7720 (SN 507351->)	\$ 98.00
30	H97929	Long Lower Feeder House Drive	6620 (SN 403301->), 7720 (SN 409101->) 8820 (SN 414851->)	\$ 105.00
31	H110921	Feeder Variable Conveyor Drive	6620, 7720, 8820	\$ 145.00

## AUGERS

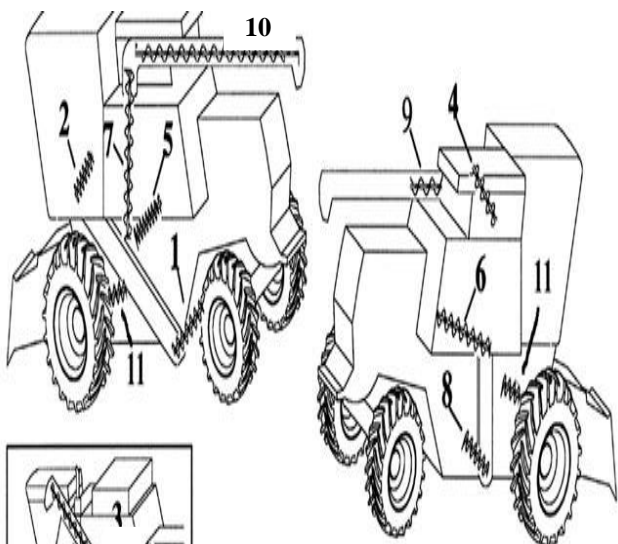

**\*MOST ITEMS ON THIS AUGER LIST ARE NON-STOCK ITEMS. TYPICAL LEAD TIME TO ORDER IS 72 HOURS.**

#	PART #	DESCRIPTION	MODEL #	PRICE
1	AH76130		4400, 4420	\$ 194.00
	AH93662		6620 (SN:<-610300)	\$ 325.00
	AH122335	AUGER LOWER TAILINGS	6620 (SN:610301->)	\$ 275.00
	AH93663		7720 (SN:<-610500)	\$ 278.00
	AH122336		7720 (SN:610501->)	\$ 239.00
2	AH76573		4400, 4420	\$ 185.00
	AH127650		6620 (SN:610301->)	\$ 325.00
	AH75435	AUGER UPPER TAILINGS	6600, 6620 (SN:<-610300)	\$ 195.00
	AH127651		7720 (SN:610501->)	\$ 290.00
	AH75436		7700,7720 (SN:<-610500)	\$ 289.00
4	AH127728	TANK LOADING	7700 (SN:163901>), 6620	\$ 375.00
	AH127729		7720	\$ 415.00
5	AH98211	FRONT TANK CROSS	6620	\$ 618.00
	AH98212		7720	\$ 665.00
6	AH103727		6620 (SN:<-600000)	\$ 515.00
	AH114715	REAR TANK CROSS	6620 (SN:600001->)	\$ 515.00
	AH103728		7720 (SN:<-600000)	\$ 500.00
	AH114716		7720 (SN:600001->)	\$ 510.00
7	AH123929	VERTICAL UNLOAD AUGER	6620,7720, 8820	\$ 740.00
8	AH76772SH		4400, 4420	\$ 215.00
	AH91283	LOWER CLEAN GRAIN	6620	\$ 235.00
	AH107442		7720	\$ 255.00
9	WN-AH143731	HORIZONTAL UNLOAD AUGER	6620,7720 (14')	\$ 880.00
10	AH114138	OUTER UNLOADING AUGER	4400, 4420	\$ 645.00
	AH76241	INNER UNLOADING AUGER	4400, 4420	\$ 635.00
	AH143729	UNLOADING AUGER	6620/7720 SN:<-610500	\$1030.00
11	AH95943	SHOE GRAIN SUPPLY (RH)	6600, 6620,7700, 7720	\$ 420.00
	AH95944	SHOE GRAIN SUPPLY (LH)	6600, 6620, 7700, 7720	\$ 475.00

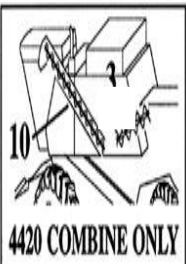

Please Call For Availability.  
PRICES SUBJECT TO CHANGE WITHOUT NOTICE!

## BELTS TO FIT JD 9000 SERIES WALKER MACHINES

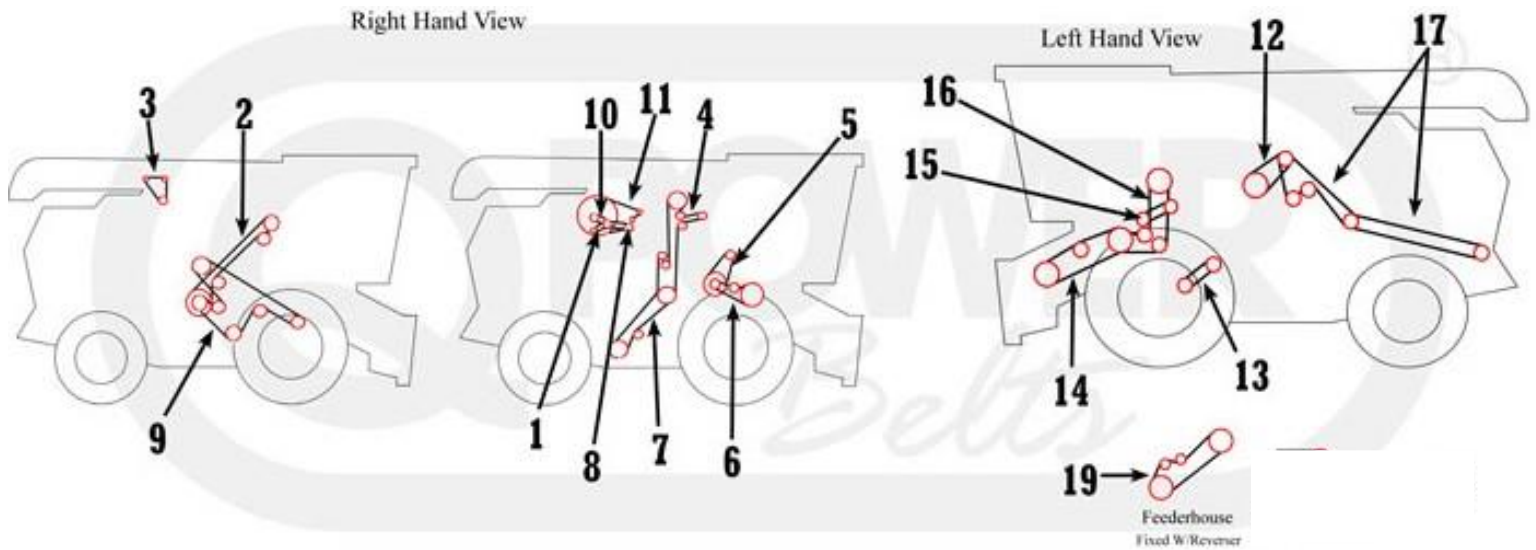

#	PART #	DESCRIPTION	MODEL	PRICE EA.
1	H134772		9400 (SN 630201-635100),	\$ 13.00
	H101813		9400 (SN 635101-636600),	\$ 15.00
	H134437	A/C COMPRESSOR	9500 (SN 630301-631100), 9600 (SN <631201)	\$ 13.00
	H81742		9500 (SN 635201-648500), 9600 (SN 631201-647500)	\$ 10.00
	H80896		9400 (SN 650101>), 9500 (SN 650201>), 9600 (SN 647501>), 9410, 9510	\$ 10.00
	H163515		9610	\$ 59.00
2	H128010	SECONDARY COUNTER SHAFT	9400, 9500, 9600, 9410, 9510, 9610	\$ 69.00
3	RE44538		9400 (SN <635101), 9600 (SN <631201)	\$ 24.00
	H101813	ALTERNATOR	9400 (SN 635101>), 9500 (SN 645201>), 9600 (SN 631201>), 9410, 9510, 9610	\$ 17.00
	H134344	ALTERNATOR (LOW POWER)	9500	\$ 15.00
	R73189		9500 (SN 635201-645200)	\$ 8.00
	H163515		9610	\$ 59.00
4	H137830		9400 (SN <640101), 9500 (SN <640200)	\$ 124.00
	H141167		9400 (SN 64101>), 9500 (SN 640201>), 9610	\$ 132.00
	H135458	CLEAN GRAIN ELEVATOR	9600 (SN <640301)	\$ 119.00
	H141166		9450, 9550, 9600 (SN 640301>) 9650CTS	\$ 125.00
	H160171	(HXE51101)	9410, 9510	\$ 149.00
5	H210476	CYL. INTERMEDIATE (DUAL RANGE) (HXE94485)	9400, 9500, 9600,9410, 9510, 9610	\$ 282.00
	H137670	CYL. INT DRIVE (EXT RANGE)	9400, 9410, 9450, 9550	\$ 319.00
6	H115881	CYL. DRIVE (REG DUAL & SINGLE RANGE)	9400, 9410, 9450, 9500, 9510, 9550, 9600, 9610, 9650CTS	\$ 185.00
	H145994	CYL DRIVE (EXT RANGE)	9400 (SN 640195>), 9410, 9450, 9650CTS	\$ 145.00
	H118618	CYL DRIVE (SLOW SPEED)	9500, 9510, 9550, 9600, 9610, 9650CTS	\$ 152.00
7	N110085	TAILINGS AUG & ELEV. LOWER	9400, 9410, 9450, 9500, 9510, 9550, 9600, 9610, 9650CTS	\$ 58.00
8	H134216		9400 (SN <640506), 9500 (SN <642579)	\$ 26.00
	H146636	ROTARY SCREEN DRIVE	9400 (SN 640506>), 9500 (SN 642579>), 9600 (SN 641922>), 9410, 9510, 9610	\$ 14.00
	H133577		9600 (SN <641922)	\$ 28.00
9	H131169	SHOE, STRAW WALKER AND CONVEYOR	9400, 9410, 9450, 9500, 9510, 9550, 9600, 9610, 9650CTS	\$ 115.00
10	H132809		9400, 9410	\$ 16.00
	H132808	(AH140623)	9500, 9600 (SN <641717), 9410, 9510	\$ 17.00
	H153297	COOLING FAN	9500, 9600 (SN 641717>), 9610	\$ 60.00
	H160405		9510	\$ 54.00
	H161795	COOLING FAN (LOW POWER)	9510	\$ 27.00
11	H143869	ROTARY SCREEN	9400 (SN <640506), 9500 (SN <642579), 9600 (SN <641716)	\$ 67.00
	H145158		9400(SN 640506>),9500 (SN 642579>),9600(SN 641717>),9410, 9510, 9610	\$ 47.00
12	AH158880	UNLOADING SYSTEM (2PC SET) (AH127866)	9400, 9500, 9600, 9410, 9510, 9610, 9450, 9550, 9650CTS	\$ 65.00

Please Call For Availability.  
PRICES SUBJECT TO CHANGE WITHOUT NOTICE!

#	PART #	DESCRIPTION	MODEL	PRICE EA.
13	H137264	SEP. FAN (SLOW SPEED)	9400 (SN <670100), 9500 (SN <670200), 9600 (SN <670300)	\$ 74.00
	H152180	SEP. FAN (SLOW SPEED)	9400 (SN 670101>), 9500 (SN 670201>), 9600 (SN 670301>), 9410, 9450, 9510, 9550, 9610, 9650CTS	\$ 89.00
	H140404	SEP. FAN (REG SPEED)	9400 (SN <670100), 9500 (SN <670200), 9600 (SN <670300)	\$ 75.00
	H152146	SEP. FAN (REG SPEED)	9400 (SN 670101>), 9500 (SN 670201>), 9600 (SN 670301>), 9410, 9450, 9510, 9550, 9610, 9650CTS	\$ 82.00
14	H161648	FEEDER HOUSE (VAR SPEED)	9400, 9500, 9600, 9410, 9510, 9610, 9450, 9550 (SN<700200), 9650 (SN<700400)	\$175.00
15	AH163931	BEATER DRIVE (75% SPEED)	9400, 9500, 9600, 9410, 9510, 9610. 9450, 9550, 9650CTS	\$ 79.00
	AH139436	BEATER DRIVE (100% SPEED)	(SET OF 2)	\$ 68.00
16	H125565	HEADER AND REEL PUMP	9400 (SN <635101), 9500 (SN <635201), 9600 (SN <635301)	\$ 121.00
	H151952	HEADER AND REEL PUMP	9400 (SN 635101>), 9500 (SN 635201>), 9600 (635301>), 9410, 9510, 9610	\$ 116.00
17	H125380	CHOPPER DRIVE (FRONT)	9400, 9500, 9600, 9410, 9510, 9610	\$ 65.00
	H125381	CHOPPER (REAR POSITION) 7/8" WIDE	9500, 9600, 9510, 9610	\$ 62.00
	E46113	CHOPPER (FRONT POSITION)	9400 (SN <640101)	\$ 35.00
	H101436	CHOPPER (REAR POSITION)	9400, 9410, 9450	\$ 48.00
	H27433	CHOPPER (FRONT POSITION) (CLEAN GRAIN COUNTER SHAFT)	9400 (SN 640101>), 9410, 9450	\$ 33.00
	H23950	CHOPPER (FRONT POSITION)	9500 (SN 640201>), 9600, 9510, 9610, 9550, 9650CTS	\$ 47.50
	P47885	CHOPPER (FRONT POSITION) (WINDROW POSITION)	9500 (SN <640201)	\$ 48.00
	19	H126345	FEEDER HOUSE (FIXED)	9400, 9500, 9600, 9410, 9510, 9610

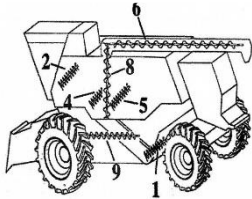

### AUGERS TO FIT 9X00-9X50 WALKER

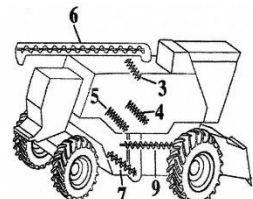

#	PART #	LENGTH	DESCRIPTION	MODEL	PRICE EA.	
1	AH146322	94.5"	LOWER TAILINGS	9400, 9410, 9450, 9500, 9510, 9550, 9560CTS, 9650CTS	\$ 299.00	
	AH146313	105.312"		9600, 9610, 9650CTS	\$ 359.00	
	JD39103	BEARING RH	\$ 17.00	RAE25RRB-I	BEARING LH	\$ 19.00
2	A-AH125895	63.062"	UPPER TAILINGS	9400, 9410, 9450, 9500, 9510, 9550, 9560CTS, 9650CTS	\$ 220.00	
	A-AH125894	71.750"		9600, 9610, 9650CTS	\$ 235.00	
	GRAE25RRB-1		BEARING RH/LH	ALL	\$ 16.00	
3	WN-AH136091	50"		9400 (SN 640101>), 9500 (SN <640200)	\$ 350.00	
	WN-AH136635	50"		9400 (SN 640101>), 9410, 9500 (SN 640201>), 9510	\$ 429.00	
	A-AH136092	56.5"	TANK LOADING	9600 (SN <640300)	\$ 429.00	
	WN-AH136636	56.5"		9600 (SN 640301>)	\$ 429.00	
	WN-AH218485HD	54.44"		(AH205897) 9450, 9550, 9560CTS, 9650CTS,	\$ 599.00	
	RA103RRB-I		BEARING	SEVERAL	\$ 16.00	
	A-AH146214	29.160"	TANK LOADING (FOLD DOWN) LOWER	9400, 9500, 9510	\$ 439.00	
	A-AH146215	29.75"	TANK LOADING (FOLD DOWN) LOWER	9600, 9610	\$ 439.00	
	AH146554	28.125"	TANK LOADING (FOLD DOWN)	9400 (SN 660101>), 9410, 9510, 9500 (SN 660201>)	\$ 289.00	
	A-AH146553	33.25"	TANK LOADING (FOLD DOWN) UPPER	9600, 9610	\$ 310.00	
	RA103RRB-I		BEARING	SEVERAL	\$ 16.00	
4	A-AXE18077	112.312"	TANK CROSS (FRONT)	(AXE18077) 9400, 9410, 9450, 9500, 9510, 9560CTS, 9650CTS,	\$ 689.00	
	WN-AH202875	123.125"		9600, 9610, 9650CTS	\$ 635.00	
	JD39104		BEARING	SEVERAL	\$ 33.00	
5	A-AXE18078	112.312"	TANK CROSS (REAR)	(AXE18078) 9400, 9410, 9450, 9500, 9510, 9550, 9650CTS	\$ 689.00	
	WN-AH202881	123.125"		9600, 9610, 9650CTS	\$ 635.00	
	JD39104		BEARING	SEVERAL	\$ 33.00	
6	A-AH112435	74"	HORIZONTAL UNLOAD	FOR USE WITH AH143731 (17') OR AH143727 (24')	\$ 679.00	
	W208PPB16-I		BEARING	FOR USE WITH WN-AH112435 AND WN-AH143727	\$ 32.95	
	WN-AH143727	129.125"(17')	HORIZONTAL UNLOAD	9400, 9410, 9450, 9500, 9510, 9550, 9600, 9610, 9650CTS	\$ 799.00	
	AH143729	201.125"		(1PC) 9400, 9410, 9500, 9510, 9600	\$1160.00	
	RA100RRB-I		BEARING	END CAP ON UNLOAD AUGER	\$ 12.00	
7	A-AH141576	92.250"		9600, 9610	\$ 379.00	
	A-AH141577	79.375"	LOWER CLEAN GRAIN	9400, 9410, 9500, 9510	\$ 339.00	
	A-AH162154	93."		9450, 9550, 9650CTS	\$ 519.00	
	JD39103	BEARING RH	\$ 17.00	GRAE25RRB-I	BEARING LH	\$ 16.00
8	WN-AH124852	43.75"	VERTICAL UNLOAD	9400, 9410, 9450 (SN <695100), 9500, 9510, 9550 (SN <695200) 9600, 9610, 9650CTS (SN <695400)	\$ 520.00	
	AH154962	EX. WEAR VERTICAL UNLOAD		9410, 9450 (SN <695100), 9510, 9550 (SN <695200), 9610	\$ 870.00	
9	A-AH130424	57.5"	SHOE GRAIN SUPPLY (RH)	9400, 9410, 9450, 9500, 9510, 9550, 9600, 9610, 9650CTS	\$ 180.00	
	A-AH130425	57.5"	SHOE GRAIN SUPPLY (LH)	9400, 9410, 9450, 9500, 9510, 9550, 9600, 9610, 9650CTS	\$ 180.00	

Please Call For Availability.  
PRICES SUBJECT TO CHANGE WITHOUT NOTICE!

## SIEVES TO FIT JD WALKER MACHINES

PART #	DIMENSIONS	DESCRIPTION / MODEL	PRICE EA.
WN-AH99750	42" X 60.76"	6600, 6620 (SER.#<610300) TOP LONG FINGER	\$ 680
WN-AH85352	42" X 46.05"	6600,6620 (SER.#<610300) BOTTOM BLUNT FINGER	\$ 565
WN-AH106772	52.87" X 60.91"	7700, 7720 (SER.#<610500) TOP LONG FINGER	\$ 730
WN-AH96771	52.87" X 46.83"	7700,7720 (SER.#<610500) BOTTOM BLUNT FINGER	\$ 560
WN-AH172951	25.67" X 35.71"	(2 REQ.) 9400, 9410, 9450, 9500, 9510, 9550 TOP LONG FINGER	\$ 370
WN-AH130160	25.67" X 48.63"	(2 REQ.) 9400,9410,9450,9500,9510,9550 BOTTOM BLUNT FINGER	\$ 370
WN-AH172950	31.1" X 35.71"	(2 REQ.) 9600-9650CTS TOP LONG FINGER	\$ 335
WN-AH130159	31.1" X 48"	(2 REQ.) 9600-9650CTS BOTTOM BLUNT FINGER	\$ 395



## STRAW CHOPPER PARTS TO FIT JD WALKER

PART #	MODEL	DESCRIPTION	PRICE EA.
AM-AH171588	4400, 4420, 6600, 6620, 7720, 8820, 9400, 9410, 9450, 9500, 9510, 9550, 9600, 9610, 9650	(1.75"X 8.5") 6 PC. STRAIGHT KNIFE SET	\$ 46.95
CF-H215004	9400, 9410, 9500, 9510 (29 USED) 9450, 9550, 9600, 9610, 9650 (35 USED)	SINGLE BEVEL (MADE IN USA) STATIONARY KNIFE	\$ 7.95
AH89918	6620, 7720, 8820, 9400 SN<640100),	STATIONARY DOUBLE KNIFE	\$ 13.95
AP23601	9500 (SN<640200), 9600 (SN<640300)	STATIONARY SINGLE KNIFE	\$ 9.95
A-AH205909	9500, 9510, 9550, 9600, 9610, 9650CTS	4 PAIR PADDLE SET	\$ 73.00
A-H167127		BUSHING FOR AH205909	\$ 6.95
A-AH205910	9500 (SN 670492>), 9510, 9550, 9600 (SN 670802>), 9610, 9650CTS	8 PC. DOUBLE BEVEL FINE CUT	\$ 49.00
A-H156100		BUSHING FOR AH205910	\$ 5.95
H114535		RH STD. FIN (NEXT TO THE END)	\$ 33.00
H114536	4420, 6620, 7720, 8820, 9400, 9410, 9450, 9500,	LH STD. FIN (NEXT TO THE END)	\$ 34.00
H114537	9510, 9550	RH INNER STD. FIN	\$ 22.00
H114538		LH INNER STD. FIN	\$ 22.00
H130948	9400, 9410, 9450, 9500, 9510, 9550, 9600, 9610,	LH OUTER STD.	\$ 42.00
H130949	9650CTS	RH OUTER STD.	\$ 42.00
H150401		RH WIDE SPREAD FIN	\$ 61.00
H150402	9400, 9410, 9450, 9500, 9510, 9550, 9600, 9610,	LH WIDE SPREAD FIN	\$ 61.00
H150403	9650CTS	RH WIDE SPREAD INNER FIN	\$ 34.00
H150404		LH WIDE SPREAD INNER FIN	\$ 34.00
AH143048	9400, 9410, 9450, 9500, 9510, 9550, 9600, 9610,	CHOPPER FLOOR	\$ 520.00
AH137792	9650CTS	CHOPPER VANE SUPPORT	\$ 479.00



## CAMERA OBSERVATION SYSTEMS

PART #	DESCRIPTION	BRAND	PRICE EA.
HD51151	SINGLE CAMERA SYSTEM 7" MONITOR	CAB CAM	\$ 395
HDS1559	DUAL CAMERA SYSTEM 7" MONITOR	CAB CAM	\$ 845
HDM1141	7" COLOR MONITOR ONLY (NON QUAD)	CAB CAM	\$ 275
VS1C110	SINGLE CAMERA ONLY W/ MOUNT	CAB CAM	\$ 140
HNS13P	CAB HARNESS FOR CC7M1C	CAB CAM	\$ 19.00
PVC-10	10' CAMERA EXTENSION CABLE	CAB CAM	\$ 13.00
PVC-20	20' CAMERA EXTENSION CABLE	CAB CAM	\$ 16.00
PVC-30	30' CAMERA EXTENSION CABLE	CAB CAM	\$ 18.00
PVC-40	40' CAMERA EXTENSION CABLE	CAB CAM	\$ 21.00
PVC-50	50' CAMERA EXTENSION CABLE	CAB CAM	\$ 24.00
PVC-65	65' CAMERA EXTENSION CABLE	CAB CAM	\$ 27.00



**OTHER ADAPTER CABLES AVAILABLE FOR OEM MONITORS!**

Please Call For Availability.  
PRICES SUBJECT TO CHANGE WITHOUT NOTICE!



# KONDEX **KX7** CONCAVES

Your harvest goals may differ from your neighboring farm or those thousands of miles away. KX7 offers diverse solutions to overcome many common harvest-time headaches. You've invested a lot in planting and cultivating your crops. Don't risk an inferior return by using an inferior concave.

-Combating rotor loss is one of the biggest ways to improve your grain profit, and KX7 is your best source for preventing losses! It is statistically impossible to completely eliminate rotor loss, but we can get you as close as possible. With KX7, losses have been consistently at less than a half percent of the field average yield (<0.5%) across multiple crops, far less than traditional and alternative concave options. This is possible due to the improved up-front threshing that allows for more separation time. The KX7 design also greatly decreases plugging, which is a main contributor to rotor loss.

-Poor separation causes trouble for farmers in many crops, particularly corn and soybeans. With KX7, you can stop worrying about delays or losses from plugging and focus on getting additional acres done. This is true not only in ideal conditions, but also in high-moisture crops. A KX7-equipped combine is an efficient and productive combine, thanks to our improved design.

PART#	MODEL / KIT TYPE	PRICE EA.
716-063	CIH 1680-7088 / THRESH START KIT	\$ 1850 SALE
716-043	CIH 1680-7088 / FULL SET	\$ 5550 SALE
716-048	CIH 7120, 7230, 8120, 8230, 9120, 9230 RAMP FULL SET	\$ 5000 SALE
716-078	CIH 7240, 7250, 8240, 8250, 9240, 9250 FULL SET	\$ 5000 SALE
716-066	JD 9650-S790 STS / THRESH START KIT	\$ 1850 SALE
716-053	JD 9650-S790 STS / FULL CONCAVE SET (CORN/SOYBEAN)	\$ 5550 SALE
716-051	JD 9650-S790 STS / FULL CONCAVE SET (TOUGH THRESH)	\$ 5550 SALE
BB7-R02	MAX ROUND ELEMENT (CIH NON-RAMP)	\$ 98.00
BB7-X04	MAX THRESH ELEMENT (CIH NON-RAMP)	\$ 98.00
BB6-R05	MAX ROUND ELEMENT (CIH RAMP/ JD)	\$ 88.00
BB6-X04	MAX THRESH ELEMENT (CIH RAMP/ JD)	\$ 88.00

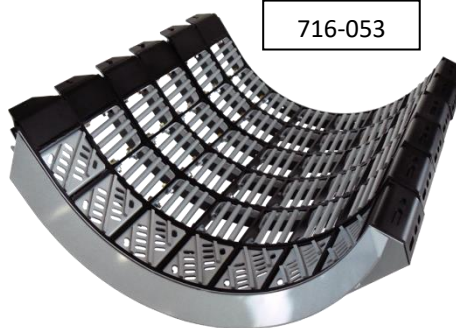
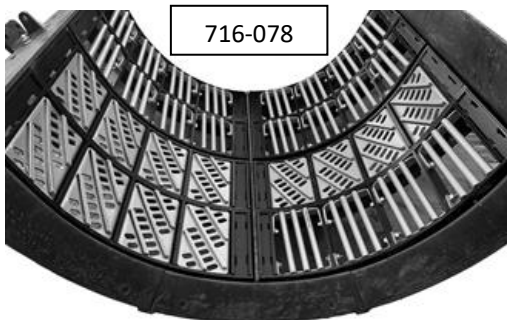
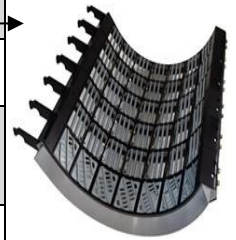

Max Thresh Box™



Max Round Box™



By having the round bars staggered from each other a disruption occurs keeping the concaves from plugging.



KX7 has the ability to move boxes around for certain threshing conditions.

Please Call For Availability.  
PRICES SUBJECT TO CHANGE WITHOUT NOTICE!

## PARTS TO FIT JD "STS" ROTOR MACHINES

PART #	MODEL	DESCRIPTION	QTY. USED	PRICE EA.
WN-AH216678	STANDARD ROTOR 9650, 9660, 9750, 9760, 9860	3 PC. ROTOR SEGMENTS (ROWS 1-5)	5	\$ 285
AH208554	9650-9870STS	3 PC. STANDARD ROTOR TINES	8	\$ 95
WN-AH216674	BULLET ROTOR 9660, 9670, 9760, 9770, 9870, S660-S790	(ROW 1) 3 PC. ROTOR SEGMENT KIT	1	\$ 539
WN-AH216675		(ROW 2) 3 PC. SEGMENT KIT	1	\$ 385
WN-AH216678		(ROW 3-5) 3 PC. ROTOR SEGMENT KIT	3	\$ 255
AH208554		3 PC. STANDARD ROTOR TINES	8	\$ 95
AH209123		3 PC. CHROME ROTOR TINES	8	\$ 199
AH204533	STANDARD ROTOR	<b>FRONT FLIGHT REPAIR KIT</b>	1	\$ 289
AH204534	9650, 9660, 9750, 9760, 9860	<b>REAR FLIGHT REPAIR</b>	1	\$ 319
AH216568	BULLET ROTOR	FRONT FLIGHT REPAIR KIT	1	\$ 505
AH216569	96-9760, 96-9770, 9870, S660-690	REAR FLIGHT REPAIR	1	\$ 529
H165407	9560, 9570, 9650, 9660, 9670, 9750,	<b>FRONT BEATER PLATE (SERRATED)</b>	30	\$ 14.95
H201914	9760, 9770, 9860-70, S670-90	<b>FRONT CURVED BEATER PLATE (SERRATED)</b>	30	\$ 26.00
H236279	9660, 9670 (SN<730200), 9760, 9770 (SN<730200)	<b>DISCHARGE BEATER WEAR PLATE</b>	10	\$ 48.00
H236284	9670 (SN 730200>) 9770 (SN 730200>)	DISCHARGE BEATER WEAR PLATE	10	\$ 38.00
716-066	9650STS-S690	<b>THRESH START KX7 KIT FOR STS</b>	1	\$ 1850 SALE
716-053		FULL SET KX7 CONCAVES STS	1	\$ 5550 SALE
WN-BH84286	9650STS-9870STS	<b>CORN/SOYBEAN CONCAVE SET LARGE WIRE</b>	1	\$ 1,995 SALE
WN-BH84226	S650-S690	<b>ROUND BAR CONCAVE SET</b>	1	\$ 2,050 SALE
H227474	9670-S790	FEEDER HOUSE SPOCKET	3	\$ 98.00
AH231006	S540, S550, 9560, 9570	<b>30 SLAT FEEDER HOUSE CHAIN</b>	1	\$ 895
WN-AH217633	9650 (SN 60049>), 9660(SN<720300), 9750 (SN 60025>), 9760 (SN:<720300)	30 SLAT FEEDER HOUSE CHAIN	1	\$ 855
A-AH217634	9650STS, 9670STS (SN: <730100), 9750STS, 9760STS (SN:720301>), 9770STS (SN:<730100), 9860STS (SN: 720501>), 9870STS (SN:<730100)	WIDE SPACED 30 SLAT FEEDER CHAIN	1	\$ 1299
WN-AXE17470	9670-9770-9870 (SN<730100)	<b>24 SERRATED CAST SLAT</b>	1	\$ 1095
WN-AXE24307	9670-9770-9870 (SN 730100>)	<b>24 SERRATED CAST SLAT</b>	1	\$ 1295
WN-AXE27247	S660-690, S760-790	<b>CAST SLAT CHAIN (4 STRAND)</b>	1	\$ 1550
WN-AH17470	9570, 9670, 9770, 9870	FEEDER CHAIN ONLY	1	\$ 655
AXE24307LS	S660, S670, S680, S690 (SN 745101>)	CHAIN ONLY (3 STRAND)	1	\$ 825
WN-AXE27247-4S	S660-690, S760-790	CHAIN ONLY (4 STRAND)	1	\$ 925
JDC100BK	ALL ABOVE	BOLT KIT W/ NUTS (110 PC.)	1	\$ 55
WN-AH216876	9670STS, 9770STS, 9870STS (SN 730101>), S650, S660, S670, S680, S690 (SN 775000>)	<b>49.2" FEEDER HOUSE DRUM</b>	1	\$ 495
WN-AH142394	9650, 9750STS	52.25" FEEDER HOUSE DRUM	1	\$ 679
WN-AH220242	9660 (SN 720310>), 9760 (SN 720401>), 9860 (SN 720501>),	51.7" FEEDER HOUSE DRUM	1	\$ 769
*220242SBK	9670-9770-9870-(SN <730100)	UPDATE BEARING KIT/ SHAFT	1	\$ 710 SALE
*220242SS		UPDATE SHAFT AND ARM KIT	1	\$ 585 SALE
A-AH220243	9560 (SN 720101>), 9570	40.937" FEEDER HOUSE DRUM	1	\$ 785
*220243SS		UPDATE SHAFT AND ARM KIT	1	\$ 560 SALE
A-AXE27254	S650, S660, S670, S680, S690 (SN 775001>)	49.125" FEEDER DRUM	1	\$ 835
WN-AXE28559	9560, 9570, 9650, 9660, 9670, 9750, 9760, 9860	<b>CA557 CLEAN GRAIN CHAIN</b>	1	\$ 510
WN-AXE28560	9770, 9870, S660, S670, S680, S760-790	CA557 CLEAN GRAIN CHAIN	1	\$ 460
WN-AXE25091	S550, S650, S660, S760, S770	CA557 CLEAN GRAIN CHAIN	1	\$ 439
AH171008	9450, 9560, 9650-60, 9750-60, 9860	CLEAN GRAIN BOOT	1	\$ 555
WN-AH138426		CLEAN GRAIN DOOR	1	\$ 79
WN-H164796	9550, 9560, 9650, 9660, 9750, 9760, 9860	UPPER CLEAN GRAIN SPROCKET	1	\$ 35
WN-H133143		LOWER CLEAN GRAIN SPROCKET	1	\$ 35
WN-H228385	9770-9870, S670-690	UPPER CLEAN GRAIN SPROCKET	1	\$ 45.00
WN-H228383		LOWER CLEAN GRAIN SPROCKET	1	\$ 43.00
WN-AH148021	9560-70STS, 9650-70STS, 9860-70STS, S660, S670	<b>RETURN GRAIN CHAIN</b>	1	\$ 235
WN-AXE10556	S680-S690	<b>RETURN GRAIN CHAIN</b>	1	\$ 255
WN-H177988	9560-70, 9650-70, 9750-70, 9860-70	UPPER RETURN SPROCKET	1	\$ 37
WN-H157043	9560-70, 9650-70	UPPER CLEAN GRAIN ELEVATOR SHAFT	1	\$ 60
WN-H220121	9770, 9870, S670-690	UPPER CLEAN GRAIN ELEVATOR SHAFT	1	\$ 82

\*BEARING KIT AND SHAFT ARE USED TO UPDATE FEEDER HOUSE DRUM ROLLER TO THE LATE 70 SERIES.

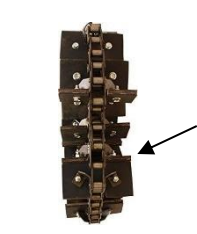
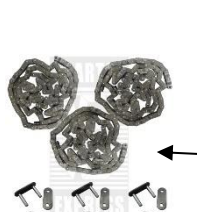
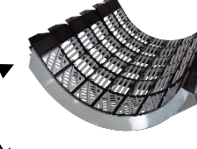

# JOHN DEERE STS COMBINE BELTS

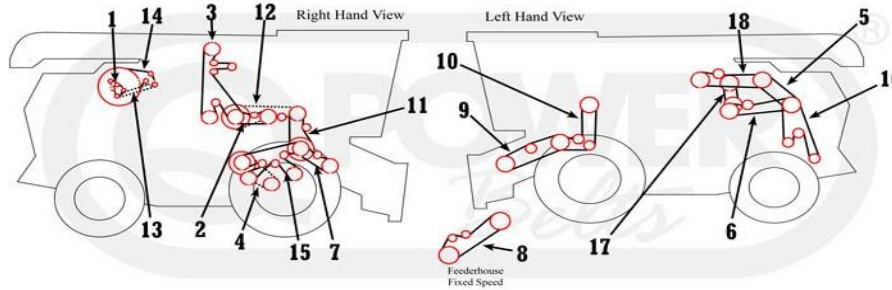

#	PART #	DESCRIPTION	MODEL#	PRICE EA.
1	R135606	ALTERNATOR (95 AMP)	9560, 9650, 9660, 9750, 9760	\$ 45.00
	R135609	ALTERNATOR (185 AMP)	9560, 9650, 9660, 9750, 9760	\$ 55.00
	R135607	ALTERNATOR (200 AMP)	9560	\$ 54.00
	R521053	ALTERNATOR (200 AMP)	9570	\$ 59.00
	AT262958	ALTERNATOR (200 AMP)	9660, 9670, 9760, 9770	\$ 72.00
	R503505	ALTERNATOR	9860, 9870	\$ 52.00
2	H154731	TAILINGS AUGER & ELEVATOR	9560, 9570, 9650, 9660, 9670, 9750, 9760, 9770, 9860, 9870, S550, S650, S660, S670	\$ 39.00
3	H218645	CLEAN GRAIN ELEVATOR	9560, 9570, 9650, 9660, 9750, 9760, 9860, S550, S650, S660	\$ 125.00
	H223230		9770, 9870, S670, S680, S690, S770, S780	\$ 209.00
4	H165072	CLEANING FAN	9650, 9750	\$ 75.00
	H206048		9560, 9660, 9670, 9760, 9770, 9860	\$ 75.00
	H230909		9570, 9870	\$ 79.5
	H211601	CLEANING FAN (SLOW SPEED)	9560, 9660, 9760, 9860	\$ 79.00
	H215389		9570, 9670, 9770, 9870	\$ 76.00
5	HXE15671	COUNTER SHAFT DISCHARGE	9560, 9570, 9650, 9660, 9670, 9750, 9760, 9770, 9860	\$ 106.00
	HXE10556	BTR & CHOPPER	(1-7/8" DUAL BAND) (STANDARD DUTY) 9670, 9770, 9870	\$ 146.00
	HXE10501		(2-15/16" TRIPLE BAND) (HEAVY DUTY) 9670, 9770, 9870	\$ 230.00
	H201596		9860 (W/ STANDARD CHOPPER)	\$ 185.00
6	H168301	DISCHARGE BEATER	9560, 9570, 9650, 9660, 9670, 9750, 9760, 9770, 9860, 9870, S550	\$ 72.00
7	H204133	FEED ACCELERATOR (STANDARD)	9560 (SN <715301>), 9650, 9660 (SN<715401>), 9750, 9760 (SN<715501>), 9860 (SN <715601>)	\$ 135.00
	H236472	FEED ACCELERATOR (STANDARD)	9560 (SN715301>), 9660 (SN715401>), 9760 (SN715501>), 9860 (SN715601>), 9570, 9670, 9770, 9870, S550, S650, S660, S670, S680S690, S760-90	\$ 149.00
	H216026 (HXE95511)	FEED ACCELERATOR (SLOW SPEED)	9560, 9570, 9650, 9660, 9670, 9750, 9760, 9770, 9860, 9870, S550, S650, S660, S670-90	\$ 139.00
	H221733	FEED ACCELERATOR (HIGH SPEED)	9660, 9670, 9760, 9770, 9860, 9870 (SN <730101)	\$ 139.00
	H230230 (HXE54503)	FEED ACCELERATOR (HIGH SPEED)	(3 BAND) 9570, 9660, 9670 (SN<720100>), 9760, 9770 (SN <730100>), 9860, 9870 (SN 730101>), S670, S680, S690	\$ 160.00
9	H157732	VARIABLE SPEED FEEDER HOUSE (STD)	(1-1/2" WIDE) 9650 (SN <700500>), 9750 (SN <695601)	\$ 209.00
	H205169	VARIABLE SPEED FEEDER HOUSE (STD)	(1-1/2" WIDE) 9650 (SN 700501>), 9750 (SN 700601>)	\$ 208.00
	H201334	VARIABLE SPEED FEEDER HOUSE (STD)	(1-1/2" WIDE) 9560, 9570, 9660	\$ 201.00
	H218726	VARIABLE SPEED FEEDER HOUSE (STD)	(1-3/4" WIDE) 9560, 9570, 9650, 9660, 9750, 9760, 9670, 9770, 9860, S550, S650, S660	\$ 285.00
	H220911	VAR. SPEED FEEDER (HIGH CAPACITY)	9660 (HIGH TRQ.), 9670, 9760 (HIGH TRQ.), 9770, 9860 HD, S660-70	\$ 355.00
10	H126345	HEADER AND REEL PUMP (STD CAP)	(1-1/4" WIDE) 9560, 9570 (SN <740200)	\$ 120.00
	H156796	HEADER AND REEL PUMP (STD CAP)	9650, 9660, 9760, 9860, 9670 (FIXED SPEED), 9770 (FIXED SPEED)	\$ 150.00
	H209507	HEADER AND REEL PUMP (HIGH CAP)	(1-15/16" WIDE) 9560, 9570	\$ 235.00
	H156541 (HXE95935)	HEADER AND REEL PUMP (HIGH CAP)	(1-15/16" WIDE) 9650, 9660, 9750, 9760, 9860, 9670, 9770, 9870, S660-90	\$ 235.00
	H229018	HEADER AND REEL PUMP	(3" TRIPLE BAND) 9670, 9770, 9870, S670-90	\$ 308.00
11	AH150678	RH JACKSHAFT (FRONT SET OF 2)	9650, 9660, 9670, 9750, 9760, 9770, 9860, 9870, S650, S660, S670, S680, S690	\$ 105.00
	AH202773	RH JACKSHAFT (FRONT SET OF 2)	9560, 9570	\$ 109.00
12	H154723	RH JACKSHAFT (REAR)	9560, 9570, 9650, 9660, 9670, 9750, 9760, 9770, 9860, 9870, S550, S650, S660, S670, 680	\$ 75.00
13	H157104	ROTARY SCREEN DRIVE (ENG. SIDE)	9650 (SN <695500>), 9750 (SN <695600)	\$ 18.00
	H201498	ROTARY SCREEN DRIVE (ENG. SIDE)	9560	\$ 17.00
	H213353	ROTARY SCREEN DRIVE (ENG. SIDE)	9560 (SN 720101>), 9570, 9660, (SN 715401>), 9670, 9760 (SN 715501>), 9770, 9860 (SN715601>)	\$ 24.00
	H206807	ROTARY SCREEN DRIVE (ENG. SIDE)	9650, 9660 (SN 695500>), 9750, 9760 (SN 695500>), 9860 (SN<715601)	\$ 18.00
	14	H157105	ROTARY SCREEN DRIVE (SCREEN SIDE)	9650 (SN <695601>), 9750 (SN <695601)
H175632		ROTARY SCREEN DRIVE (SCREEN SIDE)	9560, 9650 (SN 690338>), 9660	\$ 26.00
H175628		ROTARY SCREEN DRIVE (SCREEN SIDE)	9650 (SN695601>), 9660 (SN<715401>), 9750 (SN695501>), 9760 (SN<715601>), 9860 (SN<695500)	\$ 38.00
H221273		ROTARY SCREEN DRIVE (SCREEN SIDE)	9570, 9670, 9770, 9870	\$ 36.00
H213353		ROTARY SCREEN DRIVE (SCREEN SIDE)	9570, 9660 (SN 715401>), 9670, 9760 (SN 715401>), 9770, 9860 (SN 715601>)	\$ 26.00
15		H175587	SHOE FAN & CONVEYOR AUGERS	9560, 9570, 9650, 9660, 9670, 9750, 9760, 9770, 9860, 9870, S550, S650, S660, S670, S680
16	H235564	STRAW CHOPPER	9560, 9570, 9660, 9760, 9650 (SN 700501>), 9750 (SN 700601>)	\$ 139.00
	H201571	STRAW CHOPPER	9650 (SN <700500>), 9750 (SN <700600)	\$ 118.00
	H232997	STRAW CHOPPER	9670	\$ 120.00
	H223212	STRAW CHOPPER	9770, 9870	\$ 162.00
	H220747	STRAW CHOPPER	9860 (W/ STANDARD CHOPPER)	\$ 202.00
17	H221498 (HXE46027)	VARIABLE ROTOR DRIVE	9560, 9570, 9650, 9660, 9670, 9750, 9760, S550, S660	\$ 449.00
	H207851	VARIABLE ROTOR DRIVE	9750, 9860 (SN <705798)	\$ 729.00
	HXE63990	VARIABLE ROTOR DRIVE	(H208431) 9770, 9860 (SN 705798>), 9870, S670, S680, S690	\$ 630.00
18	AH160080	UNLOADING AUGER SYSTEM (SET OF 2)	9560, 9570, 9650, 9660, 9670, 9770, 9860, 9870, S550, S650, S660, S670	\$ 102.00

Please Call For Availability.  
 PRICES SUBJECT TO CHANGE WITHOUT NOTICE!

# AUGERS TO JD "STS" MACHINES



PART #	LENGTH	DESCRIPTION	MODEL	PRICE EA.
A-AH218246	71.562"	LOWER CLEAN GRAIN	9560, 9570	\$ 429.00
A-AH162154	82.125"		9650, 9660, 9760, 9670, 9750, 9760, 9770,	\$ 520.00
A-AH219339	(AXE59539)	LOWER CLEAN GRAIN (HIGH RATE)	9670, 9770, 9870,	\$ 719.00
GRAE25RRB-I	BEARING LH	\$ 16.00	JD10384	BEARING RH \$ 33.00
AH168284	40.625"	CLEANING SHOE (LH) HW	9570, 9650, 9670, 9750-70, 9860, 9870,	\$ 375.00
AH168285	40.625"	CLEANING SHOE (RH) HW	9570, 9650, 9670, 9750-70, 9860, 9870,	\$ 419.00
AH214862	BEARING FRONT	\$ 16.00	AH159863	BEARING REAR \$ 16.00
A-AH146786	40.75"	CLEANING SHOE (LH)	9560,9570,9650,9660,9670,9750,9760, 9770, 9870,	\$ 129.00
A-AH146787	40.75"	CLEANING SHOE (RH)	9560,9570,9650,9660,9670,9750,9760, 9770,	\$ 115.00
AH214862	BEARING FRONT SHOE	\$ 16.00	AH159863	BEARING REAR SHOE \$ 16.00
AH223220	51.875"		9560, 9570,	\$ 630.00
WN-AH218485HD	57.125"	TANK LOADING	9550, 9650, 9660, 9670, 9750, 9760,	\$ 599.00
A-AH230013	57.125"		9770, 9870,	\$ 789.00
JD10384	BEARING UPPER			\$ 33.00
WN-AH202510	61.312"	LOWER TAILINGS	9560, 9570	\$ 220.00
A-AH147472	71.87"		9650, 9660, 9670, 9750, 9760, 9770, 9860, 9870,	\$ 289.00
AH202519	25.69"	UPPER TAILINGS	9560, 9570	\$ 189.00
AH209421	28.25"		9650, 9660, 9670, 9750, 9760, 9770, 9860, 9870,	\$ 172.00
GRAE25RRB-I	BEARING LH	\$ 16.00	JD10384	BEARING RH \$ 33.00
A-AXE18077	112.75"	TANK CROSS (FRONT) AXE18077	REG. RATE 9560-70, 9650-70, 9750-60	\$ 689.00
A-AXE18078	112.75"	TANK CROSS (REAR) AXE18078	REG. RATE 9560-70, 9650-70, 9750-60	\$ 689.00
JD39104		BEARING		\$ 33.00
A-AXE18081	112.75"	TANK CROSS (FRONT) AXE18081	HIGH RATE 9660, 9670, 9760, 9770, 9860, 9870	\$ 879.00
A-AXE18082	112.75"	TANK CROSS (REAR) AXE18082	HIGH RATE 9660, 9670, 9760, 9770, 9860, 9870	\$ 799.00
AH146840	30.5"	VERT. UNLOAD (STANDARD WEAR)	9560, 9570, 9650, 9660, 9670, 9750	\$ 550.00
A-AH164070	30.5"	VERT. UNLOAD (EXTENDED WEAR)	9560, 9570, 9650, 9660, 9670, 9750-70 STS	\$ 689.00
A-AXE12921	31.625"	VERT. UNLOAD (HIGH RATE) AXE12921	9660, 9670, 9760, 9770, 9860, 9870	\$ 919.00
WN-AH112435	74"	HORIZONTAL UNLOAD (INNER)	USE W/AH143731 (20') & AH143727 (17') 9560, 9570, 9650, 9750	\$ 565.00
WN-AH169061	83.125"	HORIZONTAL UNLOAD (INNER)	9650 (SN 690501>), 9660, 9750 (SN 690601>), 9760, 9770	\$ 585.00
AH226067	84.5"	HORIZONTAL UNLOAD (INNER)	9560, 9570, 9660, 9670, 9760	\$ 722.00
WN-AH201797	95.06"	HIGH-RATE HORIZONTAL UNLOAD (INNER)	S660-690, 9660-70, 9760-70, 9860-70	\$ 870.00
W208PPB16-I (JD9373)		BEARING		\$ 31.95
WN-AH234554	95.125"	HIGH-RATE HORIZONTAL UNLOAD (MIDDLE)	S660-690, 9660-70, 9760-70, 9860-70	\$ 910.00
WN-AH143727	129.125"	HORIZONTAL UNLOAD 17' (OUTER)	9650 (W/17'), 9750 (W/17') W/AH112435	\$ 800.00
WN-AH173595	156"	HORIZONTAL UNLOAD 21.5' (OUTER)	9560-70, 9660, 9760, 9770	\$ 1100.00
WN-AH143731	165"	HORIZONTAL UNLOAD 20' (OUTER)	9560, 9650, 9750	\$ 870.00
WN-AH235525	114.5"	HORIZONTAL UNLOAD (OUTER)	9660-70, 9760-70, 9860-70	\$ 1100.00
RA100RRB-I	(JD8665)	BEARING END CAP		\$ 12.00
W208PPB16-I	(JD9373)	HANGER BEARING		\$ 32.95
A-AXE53952	264LINK	60H UNLOAD SYS. CHAIN	9660-9870	\$ 150.00



## STS TANK FILL TUBE



MODEL	PART #	DESCRIPTION	PRICE
9660-70, S650 (SN 765000>), S660 & S670 (SN 745100>), 9660, 9670, 9760, 9860, 9870	WN-AH219093	Tube; Loading Auger, Stainless Steel	\$ 700.00
9770, 9870	WN-217983	Tube; Loading Auger, Stainless Steel	\$ 780.00
S660-70, S760-70 (SN<805000)	AM-AXE56593	Tube; Loading Auger, Stainless Steel	\$ 2250.00
S680-90, S780-90 (SN<805000)	AM-AXE56594	Tube; Loading Auger, Stainless Steel	\$ 3600.00
STS TANK FILL TUBE LINER KIT			
9650-9750, 9660-9860, S650, S660, S670, S76-70	83801	LINER KIT COMPLETE	\$ 139
9560, 9650-60	83669	LINER KIT COMPLETE	\$ 129
9770-9870STS	83666	LINER KIT COMPLETE	\$ 129
S670-S690 LONG (FOLD DOWN)	83682	LINER KIT COMPLETE	\$ 129

Please Call For Availability.  
PRICES SUBJECT TO CHANGE WITHOUT NOTICE!



## JD S SERIES BELTS

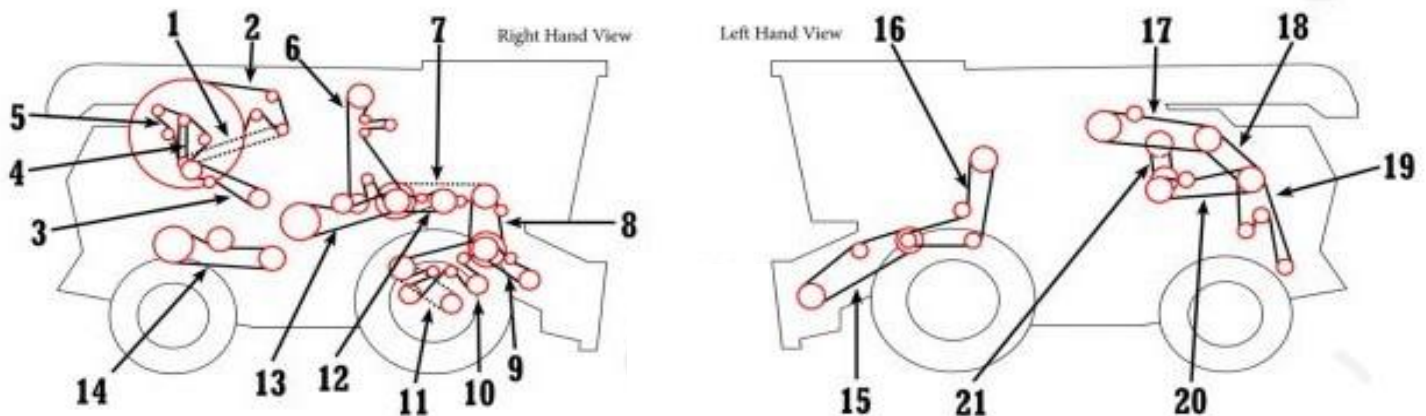

#	PART #	DESCRIPTION	MODEL #	PRICE EA.
1	H238867	ROTARY SCREEN DRIVE (ENG)	S650, S660, S670, S680, S690, S760, S770, S780, S790	\$ 24.00
2	H221273	ROTARY SCREEN DRIVE	S650, S660, S670, S680, S690, S760, S770, S780, S790	\$ 36.00
3	HXE68016	CLEANING FAN (LOWER)	S650, S660, S670, S760, S770	\$ 18.00
	HXE38073		S680, S690 (SN: 745100>), S780, S790	\$ 18.00
4	HXE68015	CLEANING FAN (UPPER)	S650, S660, S670, S760, S770	\$ 20.00
	R503312		S680 (SN 745100>), S690 (SN 745100>), S780, S790	\$ 69.00
5	HXE22617	VARIABLE SPEED FAN	S650, S660, S670, S760, S770	\$ 70.00
	H238831		S680, S690, S780-90 TIER 4	\$ 39.00
	R503505		S780-90 TIER 2	\$ 51.00
6	H223230	CLEAN GRAIN ELEVATOR	S650, S660, S670, S680, S690, S760, S770, S780, S790	\$ 215.00
7	H154723	JACKSHAFT DRIVE REAR	S650, S660, S670, S680, S690, S760, S770, S780, S790	\$ 75.00
8	AH150678	JACKSHAFT DRIVE FRONT (2 PC)	(S660-S690 SN: 745100-785000)	\$ 109.00
	HXE88564	JACKSHAFT DRIVE FRONT (1 PC)	S760, S770, S780, S790/(S660-690 SN: 785001>)	\$ 172.00
9	H221732 (H216026)	FEED ACCELERATOR (SLOW)		\$ 125.00
	HXE95511	FEED ACCELERATOR (STANDARD)	S650, S660, S670, S680, S690, S760, S770, S780, S790	\$ 149.00
	H230230 (HXE54503)	FEED ACCELERATOR (HIGH)		\$ 160.00
10	H175587 (HXE82335)	SHOE FAN & CONVEYOR	S550, S650, S660, S670, S680, S690	\$ 154.00
	HXE102288	CONVEYOR AUGER DRIVE	S760, S770, S780, S790	\$ 455.00
11	HXE15594	CLEANING FAN DRIVE (STANDARD SPEED)	S550, S650 (SN<785000), S660 (SN<785000), S670 (SN<785000), S680 (SN<785000), S690 (SN<785000)	\$ 92.00
	HXE99294		S650 (SN 785001>), S660 (SN 785001>), S670 (SN 785001>), S680 (SN 785001>), S690, S760, S770, S780, S790	\$ 94.00
12	H154731	TAILINGS AUGER & ELEVATOR	S550, S650, S660, S670, S760, S770	\$ 39.00
13	H240895	RETHRESHER DRIVE	S680, S690, S780, S790	\$ 73.00
14	H240895	OVERSHOT BEATER DRIVE	S670, S680, S690, S760, S770, S780, S790	\$ 73.00
15	HXE45928 (H220911)	HIGH SPEED VARIABLE FEEDER DRIVE	S660, S670, S680 (SN766007-78500), S760, S770	\$ 359.00
	H229019	5 SPEED FEEDER DRIVE W/OUT FORE/ AFT	S670, S680, S690, S770, S780, S790	\$ 289.00
	H174885	FIXED SPEED FEEDER DRIVE W/OUT FORE/ AFT	S650, S660, S670, S680, S690, S760, S780, S790	\$ 247.00
	HXE50398	HIGH TORQ FIXED FEEDER DRIVE W/ TILT	S660 (SN 775001>), S670 (SN <765250), S680 (SN745100>), S690 (SN<745100), S760, S770, S780, S790	\$ 455.00
	HXE47152	5 SPEED FEEDER DRIVE W/ TILT	S670 (SN <765253), S680 (SN<745100), S690 (SN<745100), S770, S780, S790	\$ 405.00
16	H229018	HEADER AND REEL PUMP W/ 5 SPEED FEEDER	S670, S680, S690, S770, S780, S790	\$ 308.00
	HXE95935 (H156541)	FRONT END DRIVE CLUTCH	S650 (SN<76500), S660, S670, S680, S690, S760, S770, S780, S790	\$ 239
17	AH160080	UNLOADING SYSTEM (2 PC)	S550, S650, S660, S670, S760, S770	\$ 102.00
	AH233198		S680 (SN<745100), S690 (SN<745100), S780, S790	\$ 132.00
18	HXE124868	UPPER CHOPPER (FINE CUT)	S650, S660, S670, S680, S690, S760, S770	\$ 371.00
	H240888	DUAL/ UPPER CHOPPER (EXTRA FINE)	S680, S690, S780, S790	\$ 345.00
19	HXE124869	STRAW CHOPPER DRIVE (FINE CUT)	S650, S660, S670, S680, S690 (H241212)	\$ 349.00
	H240974	LOWER CHOPPER DRIVE (EXTRA FINE)	S650, S660, S670, S680, S690, S770, S780, S790	\$ 239.00
	H240972	DUAL DRIVE CHOPPER (EXTRA FINE)	S650 (SN765000-785000), S660 (SN745100-765171), S670 (SN745100-785000), S680 (SN<765000), S690 (SN745100-785000), S770, S780, S790	\$ 95.00
20	HXE15556	DISCHARGE BEATER W/ FINE CUT CHOPPER	S650, S660, S760, S770	\$ 90.00
	HXE124870		S670, S680, S690, S760, S770, S780, S790	\$ 225.00
21	HXE46027	ROTOR DRIVE W/ REG, SHEAVES	S650, S660, S670 (SN765252>), S760, S770	\$ 450.00
	HXE63990	ROTOR DRIVE W/ LARGE SHEAVES	S670, S680, S690, S780, S790	\$ 629.00

Please Call For Availability.  
PRICES SUBJECT TO CHANGE WITHOUT NOTICE!

## JD S SERIES AUGERS

PART #	LENGTH	DESCRIPTION	MODEL	PRICE EA.
A-AH162154	82.125"	LOWER CLEAN GRAIN REG CAP	S650, S660, S670, S760,	\$ 520.00
A-AH219339	(AXE59539)	LOWER CLEAN GRAIN	S670 HIGH RATE, S680, S690, S780, S790	\$ 719.00
H228383	SPROCKET		SEVERAL	\$ 42.00
GRAE25RRB-I	LH BEARING			\$ 16.00
AH168284	40.625"	CLEANING SHOE HD (LH)		\$ 375.00
A-AH146786		CLEANING SHOE STD (LH)	S550, S660, S670, S680, S690, S760, S770, S780, S790	\$ 129.00
AH168285	40.625"	CLEANING SHOE HD (RH)		\$ 419.00
WN-AH146787		CLEANING SHOE STD (RH)	S550, S660, S670, S680, S690, S760, S770, S780, S790	\$ 115.00
AH163056	BEARING	FRONT		\$ 34.00
AH214862	BEARING	REAR		\$ 16.00
WN-AH233419	64"		(AXE69563) S670, S680, S690, S780, S790	\$ 859.00
A-AH230013	57.125"	BIN LOADING	S660, S670, S680, S690	\$ 779.00
WN-AH218485HD	57.125"		(AXE13122) REGULAR CAPACITY S660, S670	\$ 599.00
AXE69564	49.75"		POWER FOLD S660, S670, S760, S770	\$ 869.00
JD10384	BEARING		FOR AH218485, AH230013	\$ 33.00
HXE84650	AUGER DRIVER		LOADING AUGER DRIVER	\$ 42.00
A-AH147472	71.87"		S650, S660, S670	\$ 285.00
AM-AH232830	----	LOWER TAILINGS	S680, S690, S780, S790	\$ 399 SALE
GRAE25RRB-I	BEARING LH			\$ 16.00
JD10384	BEARING RH			\$ 33.00
H133143	SPROCKET			\$ 39.00
AH209421			S650, S660, S670, S680	\$ 185.00
AH147557	SPROCKET	UPPER TAILINGS		\$ 35.00
AXE17715			S680, S690, S780, S790	NOT AVAILABLE
A-AXE18081	112.75"	TANK CROSS (FRONT)	HIGH RATE S660-690 & S760-790	\$ 879.00
A-AXE18082	112.75"	TANK CROSS (REAR)		\$ 799.00
JD39104	BEARING			\$ 33.00
AXE18070	32.37"	VERTICAL UNLOAD	S660, S670, S680, S690, S760, S770, S780, S790	\$ 999.00
AH226068	99"	HORIZONTAL UNLOAD INNER	FOLDING-S660-690, S760-790	\$ 1055.00
H216268	COUPLING INTERNAL HALF			\$ 73.00
JD9373	BEARING			\$ 31.95
A-AH201797	95.06"		(AXE56290) HIGH RATE S660-690, S760-790	\$ 1025.00
A-AH203021	164.625"			\$ 1490.00
A-AH234554	95.125"	HORIZONTAL UNLOAD MIDDLE	S660, S670, S680, S690, S760, S770, S780, S790	\$ 915.00
AH211828	60.5"	HORIZONTAL UNLOAD OUTER	S660, S670, S680, S690, S760, S770, S780, S790	\$ 710.00
WN-AH235525	114.5"			\$ 1100.00
JD9373	BEARING			\$ 31.95
WN-AXE13749		GRAIN TANK UNLOAD HOUSING 3.3 BPS	S660-S690, S670-S790	\$ 2900.00
WN-DE19353		UNLOAD GEAR BOX UPPER	S660-S690	\$ 1195.00
WN-AXE24554		FEEDER HOUSE FLOOR 3 TAB	9650-9860,9870,S660-S690 ALL (SN <775000),S770-S790	\$ 939.00
WN-AXE36568		FEEDER HOUSE FLOOR 4 TAB	S660-S690 ALL (SN 775001>)	\$ 990.00
WN-AXE29353		FEEDER HOUSE FLOOR 4 TAB W/ FORE AFT TILT	S660-S690 ALL (SN 775001>)	\$ 870.00
A-AXE53952	264 LINK	UNLOAD SYSTEM CHAIN #60H	9560-9860STS, 9570-9870STS, S550-S790	\$ 150.00



Please Call For Availability.  
PRICES SUBJECT TO CHANGE WITHOUT NOTICE!



## "STS" STRAW CHOPPER PARTS

PART #/ # REQ	MODEL	DESCRIPTION	PRICE EA.
AH225940 (1)	9570STS, 9670-9770STS, 9870STS	BLADE KIT SET OF 8	\$ 119.00
H215212 (8)		BUSHING FOR AH225940	\$ 15.95
A-AH205909 (12)	9560, 9650, 9660, 9750, 9760, 9860	4 PAIR PADDLE SET	\$ 73.00
H167127		BUSHING	\$ 6.95
H218499 (24)	9570, 9670, 9770, 9870	BUSHING FOR NEW STYLE KNIFE	\$ 8.95
K314SS8 (1)	9660, 9750, 9760, 9860	STRAW CLAW KIT 48 PC	\$ 3200
K314SS0 (1)	S660-690, S760-790	STRAW CLAW KIT 48 PC	\$ 2750
K314SS9 (1)	9570-9870	STRAW CLAW KIT 48 PC	\$ 3010
KXE10256 (6)		SET OF 8 SERRATED KNIFE KIT	\$ 140.00
KXE10255		PADDLE KNIFE KIT (4 PAIRS)	\$ 165.00
AMHXE59496	S660-690, S760-790	CHOPPER BUSHING	\$ 5.95
AMHXE15909		KNIFE SPACER	\$ 6.95
M10X55		BOLT AND LOCK NUT	\$ 1.75
A-AH205910 (6)	9650, 9660, 9750, 9760, 9860	8 PC. DOUBLE BEVEL FINE CUT	\$ 47.00
A-H156100 (48)		BUSHING FOR AH205910	\$ 5.75
CF-H215004 (29-49)	9560-70, 9650-70, 9750-70, 9860-70	STATIONARY CHOPPER KNIFE	
K142141		(USA)	\$ 7.80

### STS CHOPPER FINS FOR 12 VANE UNITS

H236606 (2)		LH CHOPPER FIN	\$ 43.00
H204776 (2)		LHCHOPPER FIN	\$ 52.00
H204635 (1)	9560-9860, 9570-9870	LH CHOPPER FIN	\$ 40.00
H223216 (1)		LH CHOPPER FIN STRAIGHT	\$ 40.00
H223218 (1)		RH CHOPPER FIN STRAIGHT	\$ 40.00
H204571 (1)		RH CHOPPER FIN	\$ 40.00
H236607 (2)		RH CHOPPER FIN	\$ 43.00
H204777 (2)		RH CHOPPER FIN	\$ 51.00

AH149878	9650 (SN<700499), 9750 (SN<700599)	CHOPPER FLOOR	\$ 555.00
AH214452	9650, 9660, 9750, 9760, 9860	CHOPPER FLOOR	\$ 499.00
AH218187	9670, 9770, 9870	CHOPPER FLOOR	\$ 550.00
AH163595	9560-70, 9650-70, 9750-60, 9860	CHOPPER BEARING W/ HOUSING	\$ 99.50

## HYDRAULIC CYLINDERS

PART #	SIZE	DESCRIPTION	RETRACTED LENGTH	PRICE EA.
197-30080ORB	3" X 8" X 1 1/4" ROD	3000 PSI CYLINDER 8" STROKE	18.25"	\$ 235 SALE
197-30120ORB	3" X 12" X 1 1/4" ROD	3000 PSI CYLINDER 12" STROKE	22.25"	\$ 255 SALE
197-30160ORB	3" X 16" X 1 1/4" ROD	3000 PSI CYLINDER 16" STROKE	26.25"	\$ 325 SALE
197-40081ORB	4" X 8" X 1 1/4" ROD	3000 PSI CYLINDER 8" STROKE	20.25"	\$ 325 SALE
197-40120ORB	4" X 12" X 1.5" ROD	3000 PSI CYLINDER 12" STROKE	22.25"	\$ 375 SALE
197-401610ORB	4" X 16" X 2" ROD	3000 PSI CYLINDER 16" STROKE	31.5"	\$ 475 SALE
GRCS-A-KIT	1 1/2" DIA. 4 PC.	CYLINDER STOP KIT	1/2, 5/8, 3/4, 1"	\$ 64.50
GRCS-B-KIT	2" DIA. 5 PC.	CYLINDER STOP KIT	5/8, 3/4, 1, 1 1/4, 1 1/2"	\$ 89.75
22389	2" DIA. 4 PC.	CYLINDER STOP KIT	1, 1.5, 2, 4 1/4"	\$ 55.50

