

May 2023

www.nmra-scwd.org

Volume 54 No. 9

Super's Report

Phil Hottmann
Division Superintendent

I'm pleased to announce that Art Dawson has accepted the position of Superintendent. Knowing that Art served as the Rail Show chairman for twenty years I am confident that he will do an exceptional job. I believe it is important to keep the leadership fresh so new ideas will keep our club vibrant for the years to come. Again, thanks to Art for taking this role!

As the Past Superintendent I am grateful for all of you who have helped me through the past four years. We had plenty of challenges with COVID and attempting to operate the club virtually.

I'm hoping all of you will be joining us at the Spring Banquet on May 5th. It's always great to get together to celebrate the conclusion of the season, although our last meeting will be in Rockford on the 7th.

We are planning to meet at the Dutch Mill Park-N-Ride. We will plan on having lunch somewhere in Rockford prior to the meeting. We will send out more information as we get closer to the event. For more information on the Rockford agenda, you can visit their website NMRA-RRVD.

Also, be sure to sign-up for the Summer Picnic. Hopefully we will have great weather once again. John Haverberg is guaranteeing will have ketchup and mustard even if he has to bring it himself.

Next SCWD Meet
ROCKFORD, ILLINOIS

May 7, 2023 at 1 PM

Next Youth Group
Verona Senior Center, Verona

May 13, 2023 1 PM

Next BOD Meeting:

May 8, 2023 at 7 PM

ZOOM Meeting



We do have a chairperson position open. The Rail School chair is now available. Bill Clancy has this well organized and it should be fairly easy to keep this running. If you are interested, please let Art know.

Once again it has been a pleasure to serve as your Superintendent over the past years. It was a learning experience and I certainly understand the value of all of you who volunteer to make this club such a wonderful activity. I hope that the club will continue to promote this wonderful hobby for many years.

Phil

Clinic Column

By Ken Hojnacki

Many thanks to Bob Wundrock and Keith Kohlmann for two great clinics last month. While both involved photography, there was a lot to take in and each was unique. I think it was a great way to end our clinic year. I am grateful to everyone who gave in-person presentations and those who shared their presentations via Zoom, especially NMRA President Gordy Robinson who Zoomed all the way from Scotland! Without these folks, our meetings would be less fun.

For May, we will be with the Rockford Division and look forward to their programs.

I am looking ahead to next season's clinic schedule. I have a couple of people lined up already and plan to start a series of clinics to be announced as we get closer to fall. But if we want to have live presentations, we need your help. If you have an idea for a clinic on some facet of modeling or railroad operations, please email me and let's discuss it. I can help get your program in PowerPoint. And let's not forget the What Have I Been Doing segments. We haven't had any of those recently but with a few months of modeling time before fall there should be something new you can share with the members. 10 minutes or so is all it takes to show a few photos of what you have been up to.

I hope you have enjoyed the variety of programs this past year and look forward to exploring more for next year.

Ken

Contest Column

Dave Down, Chair

The schedule of popular vote contests for the 2022-23 year is complete. Thank you again to everyone who submitted entries this year. Modeler and photographer of the year will be announced at the banquet in May.

My focus is now shifting to the 2023-24 contest year and I am looking for themes for the monthly contests. I have received a couple ideas, but would like more. The plan is to have next season's themes ready for the next Bad Order, so I need your ideas now rather than later.

Dave

Layout Tours

Phil Hottmann Chair

I think everyone that visited Ron Halvorson's layout after April's meeting really appreciated all the work he has done recently. This is a very well detailed layout. It looks like it's one of those layouts that would be really fun to operate on!



Thanks to all of you who have opened your layouts this past season.

For May we will be seeing two layouts in the Rockford area. Harold Hereen's TP&W and Gene Wheeler's C&NW Sterling Subdivision.

I have a few layouts on the list to be open for next season. I will be looking for many more. If you are thinking about having your layout open, please let me know.

It would be great to have a new Layout Tour chairman. If you are interested in this position please let Art or myself know.

Phil

AP Corner

Ken Hojnacki



At the April meet, I announced that the Division will be sponsoring a training session for members interested in learning about how models are evaluated for Achievement Program requirements. Our old friend Gary Children has agreed to hold a class to go over the scoring procedures and we intend to have some actual models that can be evaluated so we can see first hand how it is done. I currently have 8 people who have expressed interest. I will try to set the session up for a Saturday or Sunday in late summer or early fall.

If you are interested in joining us, check out last month's AP Corner column for more details and email me at khojnacki@charter.net and I'll add you to the list.

Ken

Youth Group

By Steve Preston



Hi all, the youth group met at the Verona Senior Center because it was a lot quieter and more room to spread out. Our group consisted of Phil Hottmann, Bill Mitchell, and Steve Preston.

The group brought their dioramas to work on adding more stuff on them. The weather was nice and we were able to do some of the messy stuff outside. Phil showed the kids how to add dirt and gravel to their Styrofoam base. Some added more Styrofoam to build up hills and did some carving on them to make it look rocky.

One little guy who is 7 years old wanted to build a tunnel. We gave him some stuff he could use to trace the tunnel entrance and exit to carve out. He then traced the template and proceeded to use his olfa knife to cut the foam out. His dad watched with patience as his son hacked away at the foam and not a straight line could be found. Then little Charlie measured the sides and top to finish it off. 5 glue sticks later and some very rough looking tunnel material, he had made a tunnel that made the Moffat tunnel look like a gopher hole. He'll put the final finishes on it next month. Dad took a marker and put the date he made it on the inside. Who knows, we might have a master modeler in the making.

Each kid got a dog figure to add to their art work. Some have some good ideas as to what they want, I know little Charlie already has big plans for his diorama.

Thanks to all that showed up and helped.

Steve Preston
Membership Chairman and Youth Group Director

Modeling Project

Mike Vivion

Well the Winter's snow has come and gone, along with this year's modeling project: "SNOW". Slightly more than half of those who signed up last Fall returned their completed projects for display and popular vote judging at our April meeting. I am pleased to announce the winners as follows: HO scale winners were Dave Casey (1st place), Phil Hottman (2nd place) and Chris Bradley (3rd place), and for N scale Mike Vivion won 1st place as the only N entry. See the adjacent photos of these winners.

Thanks again to all who participated in this year's project. I am looking for suggestions for next year's project so drop me a note or email me any time between now and September. Have a great Summer!

Mike Vivion
Modeling Project Chair



HO First Place Dave Casey



HO Second Place Phil Hottmann

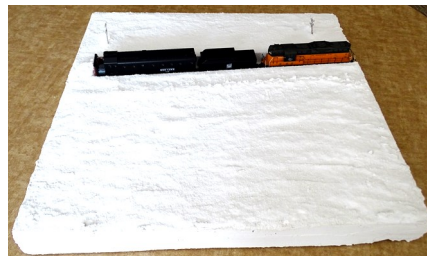

HO Third Place Chris Bradley



N Scale Mike Vivion



It's banquet time!

May 5th 2023

To be held at the:
American Legion Hall
207 Legion Street
Verona, WI 53593
Cocktails at 6pm



Dinner will be served starting at 7pm — so don't be late.

Reservations must be received by May 1st

Cost of meal: SCWD/NMRA members, \$15.00

Non-NMRA attendees, \$25.00

Children 12 & under, \$5.00

Name:	Rail	Non-Rail	\$

Note: If you are an NMRA member, your spouse, child over 12 or significant other is the same price as you.

Make sure you indicate rail or non-rail. If more than 4 then add to a separate piece of paper and send it along with your reservation

Address: _____

City: _____ WI Zip _____

Send your reservation to:

Phil Hottmann
1147 Willow Run
Verona, WI 53593

Amount enclosed: \$ _____ Checks should be made payable to the S.C.W.D.

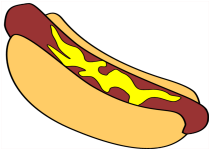

SCWD 2023 Annual Summer Picnic

Saturday, July 15, 2023



For the past several years, except for 2020, the SCWD has held a catered picnic at Little Amerricka Park in Marshall on their “Whiskey River Railway Day”. The SCWD Board has agreed to do so again this summer on Saturday, July 15th. Reservations have been made with the amusement park for use of their Blue Rose Pavilion and catering is being arranged. The park opens at noon and closes at 5 pm. Lunch will be served starting at 1:00 pm. As was done in 2019 and 2022, the Board has decided to defray part of the catering cost by charging a \$5.00 fee for each attendee, six years old and above. Five and under get the meal for free. Railway equipment can be viewed for free, but train and other rides require purchased tickets from the Park. SCWD members and their families, Youth Club members and their families and other invited guests approved by the Board can attend the picnic. To determine the food quantities for the caterer, you will have to sign up and pay by Saturday, July 1, 2023.

Little Amerricka is located on STH 19 on the east edge of Marshall. Parking directly at the Blue Rose Pavilion can be reached off Box Elder Rd. intersecting USH 19 just east of the Park’s regular entrance.

SCWD 2022 Annual Picnic Sign-up and Payment Sheet

SCWD Member and Family Attendee(s) names:

Cost(each):

Total Enclosed \$ _____

Please print and fill out the form and send with payment (cash or checks - payable to the SCWD) by 7/1 to:

**John Haverberg
4797 Delmara Rd.
Middleton, WI 53562**



Any questions, contact me at E-mail address:
haverdj@tds.net, Phone: 608-836-7963

Verona Senior Center
108 Paoli Street
Verona, WI 53593

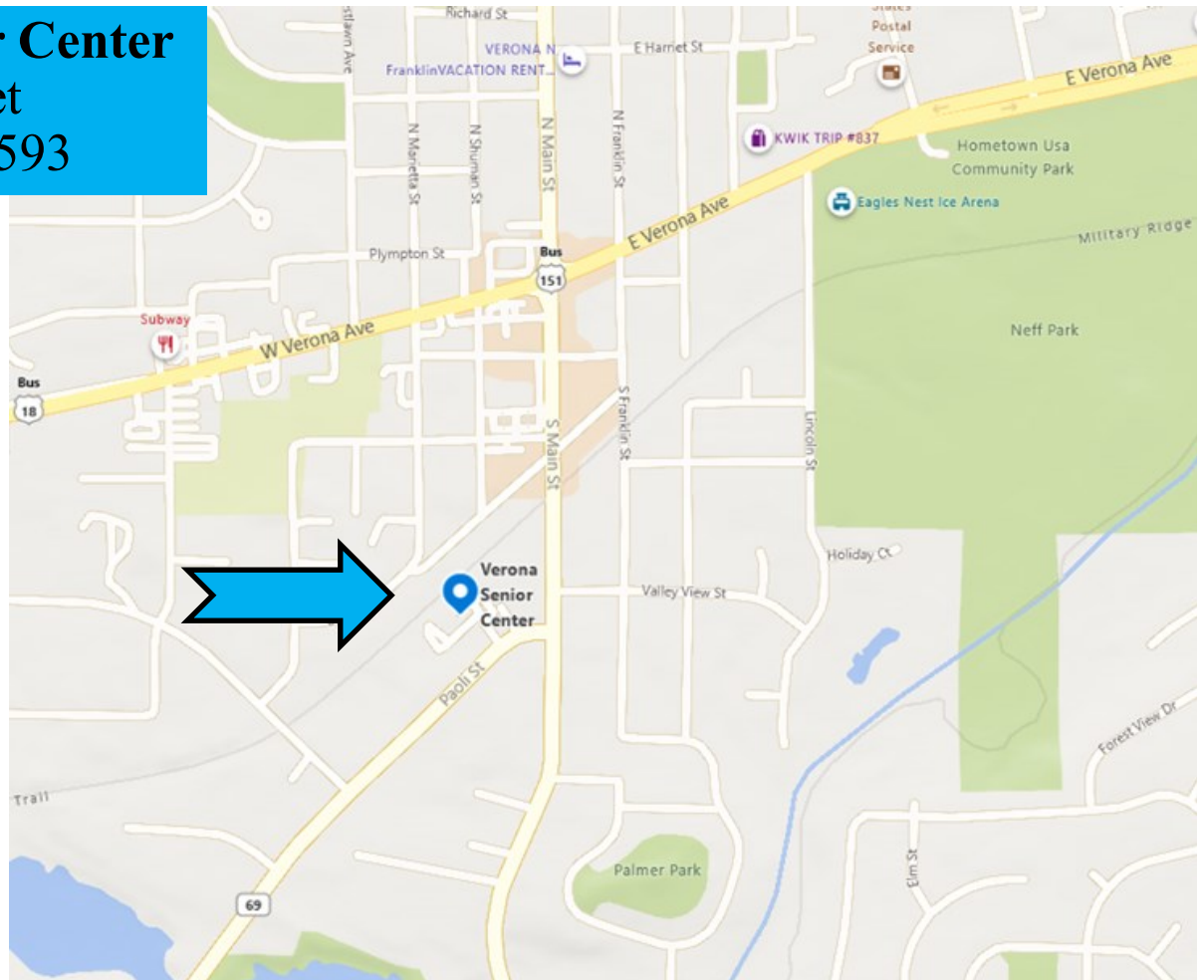

A Puzzle for You

You like trains, or train watching, but have you ever wanted to go to an OPS (Operating Session) and run trains on someone else's layout, but were afraid you wouldn't know what to do?



Model Railroad Operation is a fun and interesting role-playing game where the players (operators) use model trains to simulate the movements of the prototype railroad. Operators fill the roles of railroad employees like engineers, conductors, yardmasters, dispatchers, and more. Many of our SCWD members participate each month at multiple layouts to enjoy this fun and stimulating practice of critical thinking and problem solving in the context of railroad operations.

Now, there is a way for you to get your feet wet in this critical thinking and problem-solving railroad environment in the privacy of your own home through the use of railroad switching puzzles.

In July 2020, a group of SCWD members started a project to introduce more of our members to the enjoyment of railroad operations, or as our wives call it, playing trains. Some of us have been engaged in operating sessions for 20 years or more, and would like to get more of you involved.

The project involves getting one to solve a series of train switching puzzles (on paper, or your computer) in the least number of moves possible. You can then submit your solution to see if yours was done in the least number of moves.

Beginners can start with **3 introductory puzzles** to show the kinds of skills used in railroad switching operations. Then, you can advance to a series of more advanced puzzles written and based on actual SCWD member area layouts. Or, if you have already been to an OPS session, you could do an introductory puzzle, and jump right into the more challenging ones.

Join the SCWD listserv now and begin learning what this is all about!

Email Steve Lanphear at scwdmemberlist@mhtc.net to be added to the list and start receiving your puzzles now!

Happy Railroading!
Steve



Enjoy receiving interesting rail photos, model railroad tips, Operating puzzles, and challenging Mystery Photos??

Join The 120+ SCWD members and members from other Midwest Regional Divisions who are participating in the SCWD listserv. You can expect 5 - 10 photos of railfan photos or model railroad photos or other items per week on average, as well as SCWD announcements, monthly Mystery Photo contests, Modelers Corner, and OPS Corner Puzzles. The listserv has been running this since April 2012, and it has been quite popular.

The listserv is a one-way email broadcast to you, not a social media type service. The emails are sent in bulk, but as a BCC: type email.

Please save this email so you know how to get a hold of me. So, if you would like to try out this FREE member service, just send me your **Name** and **email address**, and **City/State** to the address below. You may drop out at any time by sending an email stating such to the same address below.

Steve Lanphear
SCWD listserv Coordinator
scwdmemberlist@mhtc.net



OPS Puzzles

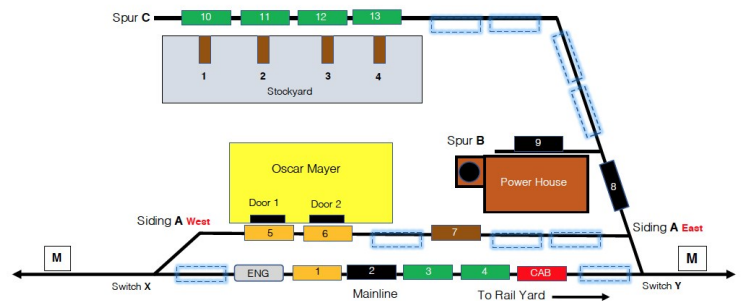

OPS Puzzles have arrived! We now have a section on the SCWD Website that has all 11 puzzles that we have published on the listserv, including the handouts and diagrams. You can start from the beginning, or pick and choose which puzzles you would like to try.

www.nmra-scwd.org/ops-puzzles.html

Steve Lanphear and the Puzzle Development Team.



NMRA NEWS



TEXAS EXPRESS    

AUGUST 20-26
Dallas/Fort Worth
GAYLORD RESORT, GRAPEVINE

SUPERCHARGED - HIGH SPEED - STREAMLINED

NATIONAL TRAIN SHOW

August 25-27

SPENCER CHRISTIAN

Banquet Speaker

GAYLORD RESORT

4-star Hotel and Water Park

BNSF HQ TOUR

Dispatching Center and Intermodal Yard

CLINICS

SIG ACTIVITIES

LAYOUT TOURS

OPERATION SESSIONS

CONTEST AND DISPLAY

FREEMO-N OPERATIONS



RAIL TOURS

- Texo Grain Mill
- Private Railcars
- TexRail Back Shop
- Texas State Railroad
- Trinity Rail Car Plant
- BNSF Intermodal Yard
- Six Flags Railroad Shop
- Grapevine Vintage Railroad
- McKinney Ave Trolley Shops
- Trinity Tank Car Cleaning Plant
- BNSF National Operations Center
- Museum of the American Railroad
- BNSF Private Western Art Collection
- T&P, Santa Fe, & Dallas Union Stations
- Fort Worth & Western Railroad Back Shop
- Union Pacific Dallas International Terminal
- Light Rail & Commuter Shops (DART & TRE)

GENERAL INTEREST

- George W Bush Library
- Fort Worth Stockyards
- Grapevine Wine Tour
- Sixth Floor Museum
- Fort Worth Modern
- Holocost Museum
- Kimbell Museum
- Globe Life Park
- AT&T Stadium
- Dealey Plaza

NMRA *National Convention*
2023 TEXAS EXPRESS.COM



Minutes SCWD Board Meeting 7:00 pm, 13 March 2023 via Zoom meeting



The meeting of the South Central Wisconsin Division Board of Directors was called to order at 6:39 pm by Superintendent Phil Hottmann. Phil Hottmann, Bob McGeever, John Kosobucki, Dave Dingman, Dr. Bill Clancy, Steve Preston, and Bill Mitchell were present. John Haverberg attended as a guest. (Meeting start times may vary due to BOD members schedules.)

BOD Meetings: Members of the SCWD are invited to join a Board of Directors meeting. Meeting dates are published in the **Bad Order**. Send a request to Phil Hottmann or another member of the SCWD Board for a ZOOM link to the upcoming meeting. The members' contact information is in the **RED BOOK**.

Picnic - John Haverberg - The SCWD July Summer Picnic is scheduled for July 15, 2023, at **Little Americka Park** in Marshall on their "Whiskey River Railway Day". John is working with the caterer to finalize the menu. SCWD Youth Group members will pay \$5.00 to attend.

*2023 Summer Picnic: Adults, Youth Group Members, Children Age 6 years old and above \$5.00
Children 5 years old and under FREE*

Spring Trip - John Haverberg is canceling the Spring Trip. At least 31 people were needed to cover the cost of a coach bus but only 12 people expressed an interest.

Minutes

Motion by McGeever, second by Dingman, to approve the minutes of the February 13, 2023, meeting which included grammatical corrections suggested by John Kosobucki. Motion carried.

Paymaster Report

Bob McGeever presented the highlights of the February Paymaster Report. He is still waiting for an invoice for the final payment for the use of the Dane County Alliant Exposition Center. Motion by Mitchell, second by Preston, to approve the February Paymaster Report as written. Motion carried.

Committee Reports

Achievement Program - Nothing to report.

Advertising - Nothing to report.

Bad Order - Articles are due for the April newsletter by March 14th.

Special Note 1: The email list comes directly from the NMRA membership list, so please keep your membership active and your email current with the NMRA. All SCWD members are requested to inform the NMRA when their email address changes.

Special Note 2: Kathy, our newsletter editor, is always in need of articles. Please submit articles as soon as possible to have them included in the next publication of the Bad Order to SCWDKATHY@AOL.com via email with attachments in a WORD formatted document.

Clinics - Clinics are being lined up for the April membership meeting.

Contests - Model and Photography - Dave Down - The contests are finished for the season. Results will be posted in a future edition of the **Bad Order**.

*From the February minutes: The May contests are canceled due to the joint meeting.
Details of the May joint meeting will be announced at a later date.*

Modeling Project - The modeling projects are due at the SCWD Membership Meeting on April 2, 2023.

Door Prizes - The door prizes are all purchased.

Layout Tours - The layout tours are in the process of being lined up for April. Phil is still looking for an additional layout tour in the Sun Prairie area. We need members to suggest layouts to be set up for tours.

Our SCWD organization is always looking for more people to host virtual or in-person layout tours. Please contact Phil Hottmann about the possibility of opening up your layout for a virtual or in-person tour. Phil's contact information is in the REDBOOK.

Membership - Steve Preston - There are a few members that still need to renew their membership. Letters have been sent out.

The current SCWD membership list is sent to Steve Preston on a monthly basis. The email address of the SCWD members associated with the membership list is used for the Constant Contact electronic communications system. Each member is responsible for making sure that their email address is valid. If someone has problems renewing their NMRA-SCWD membership using the ON-LINE systems, please contact Steve Preston. His contact information is in the RED BOOK.

Publicity - Nothing to report.

Rail School - The new Rail School Coordinator still needs to be found.

Rail Show - Bob McGeever will be meeting with the Dane County Alliant Energy Exposition Center staff and hopes to sign a contract for the 2024 February Model Railroad Show and Sale.

Website - The website looks good. New video links have been posted.

Old Business:

Youth Group - Steve Preston - The group now has a good inventory of **HO E-Z Track** including turnouts and diamonds. The Youth Group appreciates the donations of equipment. The **Noble Knights Games** meeting space used for the March Youth Group meeting was a bit cramped. Phil Hottmann will check out the possibility of moving the Youth Group meetings to the Verona Senior Center.

Youth Group Notes - Youth 18 years of age and under are welcome to join the SCWD Youth Group. A parent or designated adult is required to attend with the youth. The Youth Group Committee is looking for more members. Also, SCWD members are needed to present model railroading topics.

Spring Banquet - Phil Hottmann is finalizing the menu. The banquet is scheduled for Friday, May 5th, at the Verona American Legion Hall. Cocktails Hour is at 6:00 pm. Dinner will be served around 7:00 pm. The event details will be published in the **BAD ORDER** as more details become available.

2023 Spring Banquet: SCWD/NMRA members	\$15.00
Non-NMRA attendees	\$25.00
Children 12 & under	\$5.00

If you are an NMRA member, your spouse, child over 12 or significant other is the same price as you.

Microphone Issues at the Verona Senior Center - The March membership meeting experienced issues with the cordless microphone. This issue should be resolved at the April 2nd membership meeting.

New Business:

Name Tags - An announcement for SCWD members to purchase name tags will be placed in the **Bad Order**. If more members purchase name tags, the per unit cost will be less.

ListServ - Steve Lanphear is experiencing some problems with accessing the **ListServ** computer system. As a result, the generation of messages from **ListServ** are on hold.

Annual Awards - The board discussed the possible SCWD members who may be eligible to receive awards at the Spring Banquet. A motion was made by McGeever, second by Mitchell, to table the discussion until the April 10 SCWD Board of Directors Meeting. Motion carried.

BOD April 2nd Election - Dr. Clancy has announced that he will not be up for election to the SCWD Board of Directors. Art Dawson has decided to be a candidate for the SCWD Board.

Adjournment:

A motion was made by Kosobucki, second by Dingman, to adjourn the meeting. Motion carried. The meeting was adjourned at 7:35 pm.

Bill Mitchell - Clerk

**FROM the NMRA
Please Keep in Touch**



Please make sure the NMRA has your current contact information. You will not be able to access the full range of NMRA benefits unless we can reach you.

- Please visit nmra.org/members
- Use your email address and password to log in.
- If you have not yet registered, or forgot your password, there are buttons for that. Take a moment to easily correct any problems.
- Once logged in, click on Member Info (top right corner).
- Make sure your information is correct.
- If not, please go to:

nmra.org/request-membership-info-changes

to submit a request for changes to be made.

Thank you!

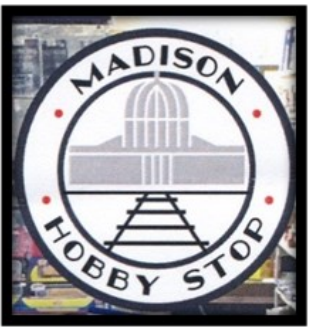

MADISON HOBBY STOP

6622 Mineral Point Road, Madison, WI 53705

Ph: 608-829-3820 • Fax: 608-829-3852 • www.madisonhobbystop.com

Hours: Monday – Friday (10 am – 8 pm) and Saturday (10 am – 5 pm)

Model Railroading • Plastic Model Kits • Rockets & Accessories • Pine Car •
Paints • Tools & more!

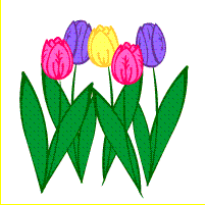

HAPPY SPRING!!

**Before the yard work begins,
time to finish up the work on the layout.**

I have most supplies in stock always or can get.

**New/old stock continues to come in weekly,
stop in before it's gone!!**

We are now closed Sunday's till the end of November

Thank you for your continued support.



**Preorders are 25% off regular price except
Walthers Proto which is 20% off**

New/old consignment coming in weekly, stop in for best selection

**Remember, most model railroad items are 20% off
with a valid NMRA or other club id card**

Excludes discounted or sale items, magazines, and consignments

Gift Certificates Available

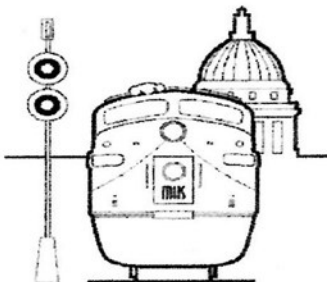

Madison Hobby Stop
Chris Roosli, Proprietor

The Hobby Depot

Brian Stackpole, owner



See us on the web at: www.hobbydepotmonroe.com



**835-17th Street
Monroe, Wisconsin 53566**

Phone: 608-325-5107

Call ahead to be sure we're open!

email: hobbydpo@tds.net

TRAINS & MORE

South Central Wisconsin Division of the National Model Railroad Association

Publishes eleven issues yearly of the

BAD ORDER

Official Mailing Address:

BAD ORDER

3940 Trempealeau Trail

Verona, WI 53593

Photos in the Bad Order, unless otherwise noted,
are by Kathy Clancy

Deadline for submissions: **14th of the month
prior to publication.** Email Bad
Order Editor at SCWDKATHY@AOL.com



**If you change your
email address**

don't forget to notify
the NMRA and
Kathy Clancy
Bad Order Editor

Thank you!

Place your ad here!!!

Contact

Kathy Clancy

Bad Order Editor

SCWDKathy@aol.com

PLEASE PATRONIZE OUR AREA HOBBY STORES

The Hobby Depot – 835 17th Street – Monroe WI
Madison Hobby Stop – 6622 Mineral Point Rd (inside Clock Tower) – Madison WI *

* = Train Show Ticket advance sales

SCWD 2022-2023 Meeting Schedule

Regular Meeting	BOD	Youth Group
May 7, 2023 (Rockford)	May 8, 2023 June 12, 2023 August 14, 2023	May 13, 2023

A Word about Constant Contact e-mail

Each Constant Contact e-mail includes links to update or unsubscribe your e-mail address. **Please do not use these links.** If you unsubscribe using the Constant Contact link, your e-mail address will be removed from the NMRA membership database, from the Midwest Region e-mail database and probably from your Division's records. If you get an e-mail that you don't want, just hit the delete key. Furthermore, if you use the update link, your change may not be timely posted to the NMRA membership database.

If you need to change your email address with the NMRA please follow these directions:

The direct way is to log on to the "Members" page of the NMRA website, choose the "View your NMRA membership" box on the right side of the screen, scroll down to the bottom of the page and select "Update". Enter the new email address in the appropriate box and click "Submit".