

LCHA June 2021

Western Showmanship

Show Date: 06-12-2021

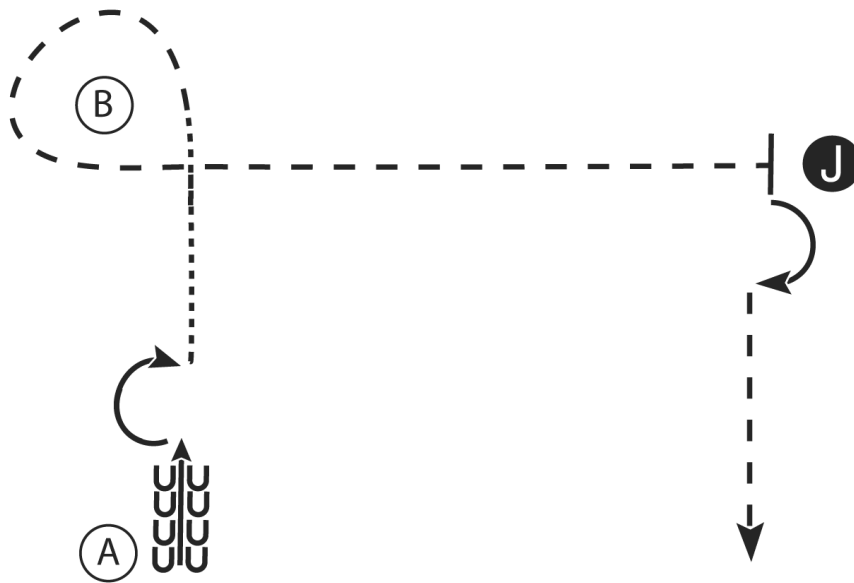

1. At A back 4 steps
2. Perform a 180 degree turn
3. Walk to B
4. At B trot around B and to the judge, set up for inspection
5. When dismissed perform a 90 degree turn and trot straight away from the judge

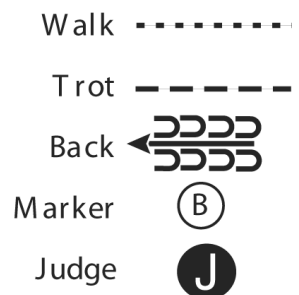

[S/2-1]

Pattern Provided by:

LCHA June 2021

Ranch Showmanship

Show Date: 06-12-2021

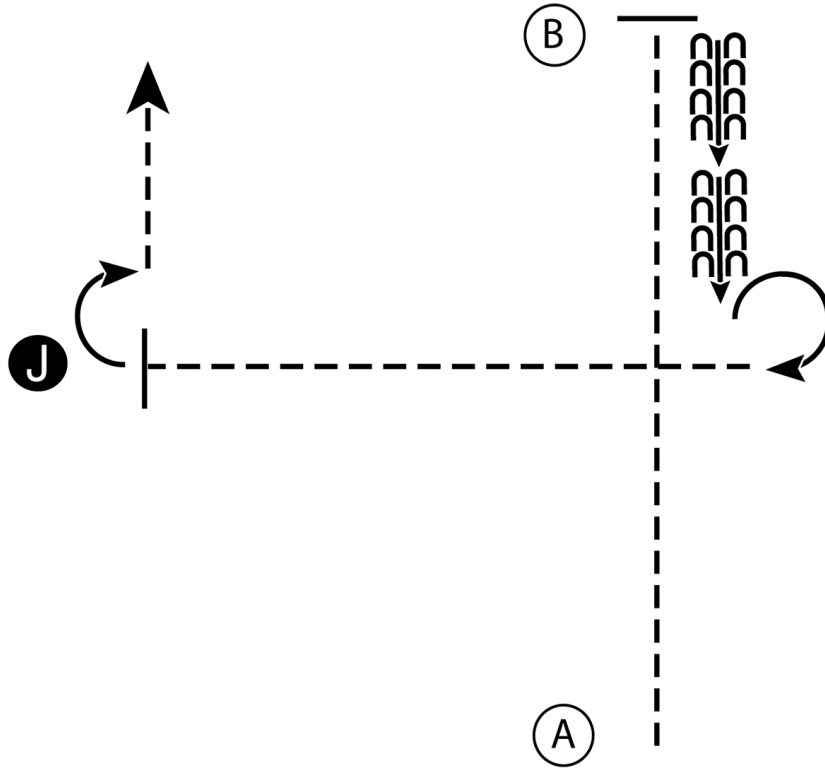

1. Trot A to B
2. Stop at B and back halfway to A
3. Stop and perform a 270 degree turn
4. Trot to judge and set up for inspection
5. When dismissed perform a 90 degree turn and trot away from judge

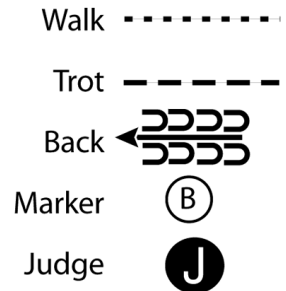

[S/2-3]

Pattern Provided by:

LCHA June 2021

Trail

Show Date: 06-12-2021

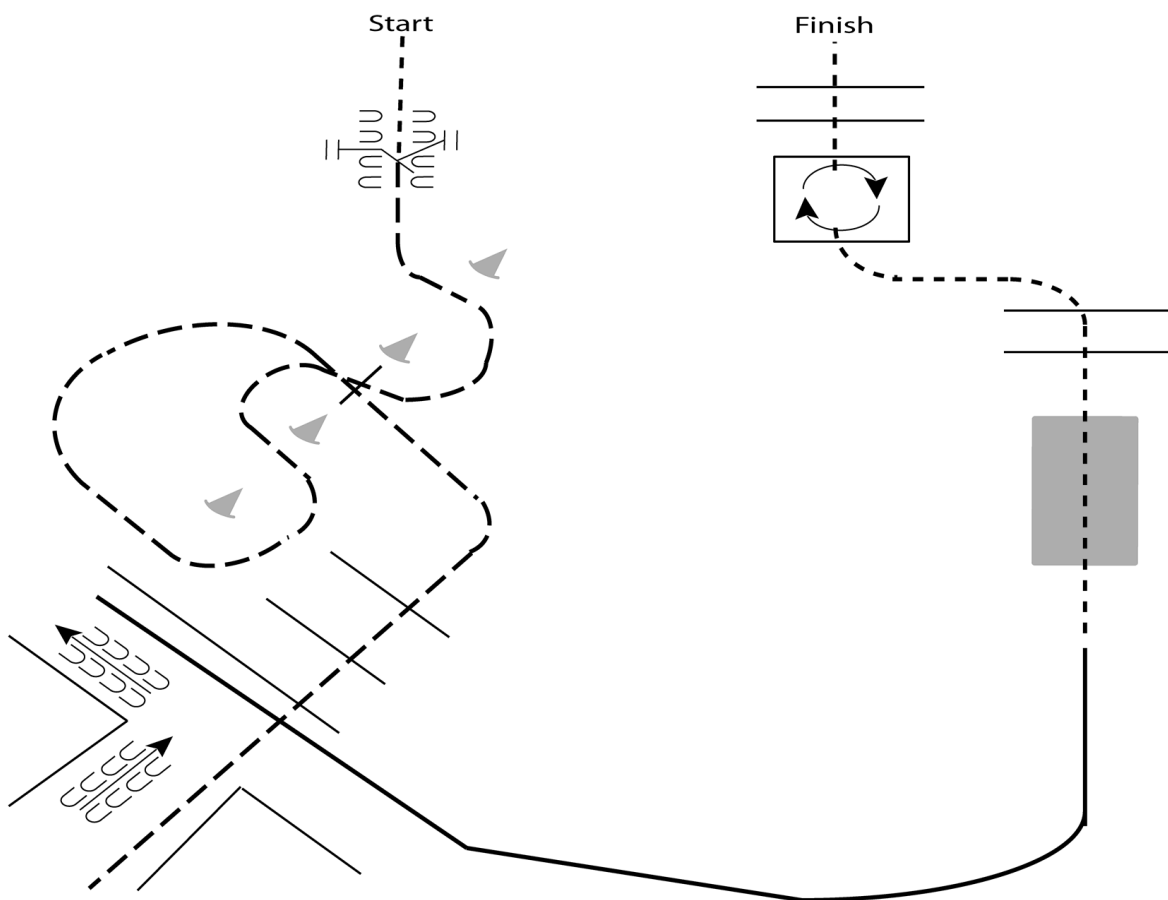

1. Walk to and work gate.
2. Jog through cones and into chute.
3. Back the L.
4. Lope on the left lead to bridge.
5. Walk over bridge and elevated poles.
6. Walk into box and perform a 360 degree turn to the right.
7. Walk out of box and over elevated poles to finish.

Walk	-----
Jog	- - - - -
Extended Jog	- - - - -
Lope	—————
Leg Yield	
Lead Change	— / —
Back	← ← ← ← ←
Marker	Ⓚ
Sidepass	←-----→

www.HorseShowPatterns.com

www.HorseShowPatterns.com

[T/1-4]

Pattern Provided by:

LCHA June 2021

In-Hand Trail

Show Date: 06-12-2021

w w w . H o r s e S h o w P a t t e r n s . c o m

w w w . H o r s e S h o w P a t t e r n s . c o m

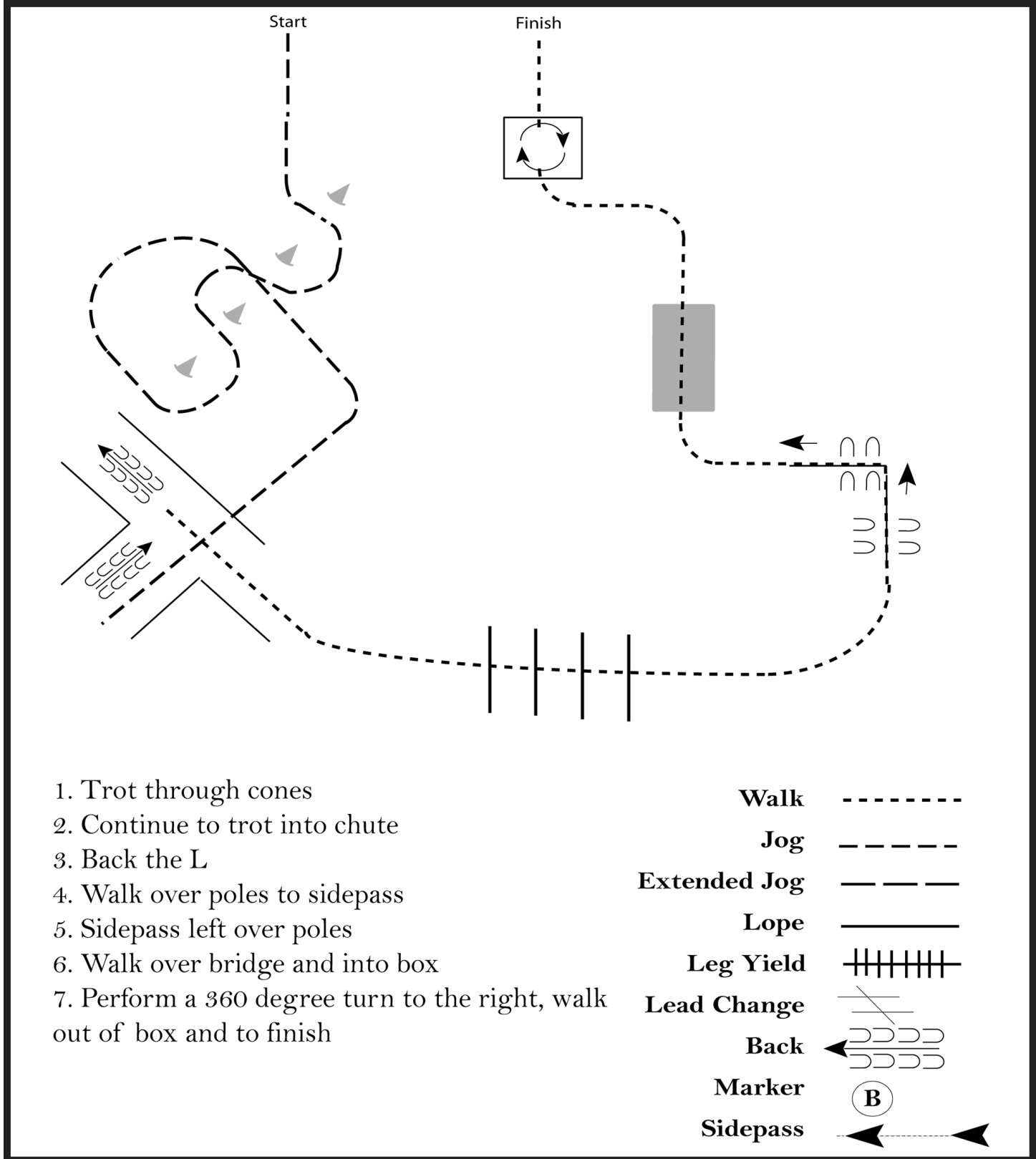

1. Trot through cones
2. Continue to trot into chute
3. Back the L
4. Walk over poles to sidepass
5. Sidepass left over poles
6. Walk over bridge and into box
7. Perform a 360 degree turn to the right, walk out of box and to finish

Walk
Jog	-----
Extended Jog	- - - - -
Lope	—————
Leg Yield	
Lead Change	///
Back	← U U U
Marker	ⓑ
Sidepass	← - - - - →

[T/1-3]

Pattern Provided by:

LCHA June 2021

Reining

Show Date: 06-12-2021

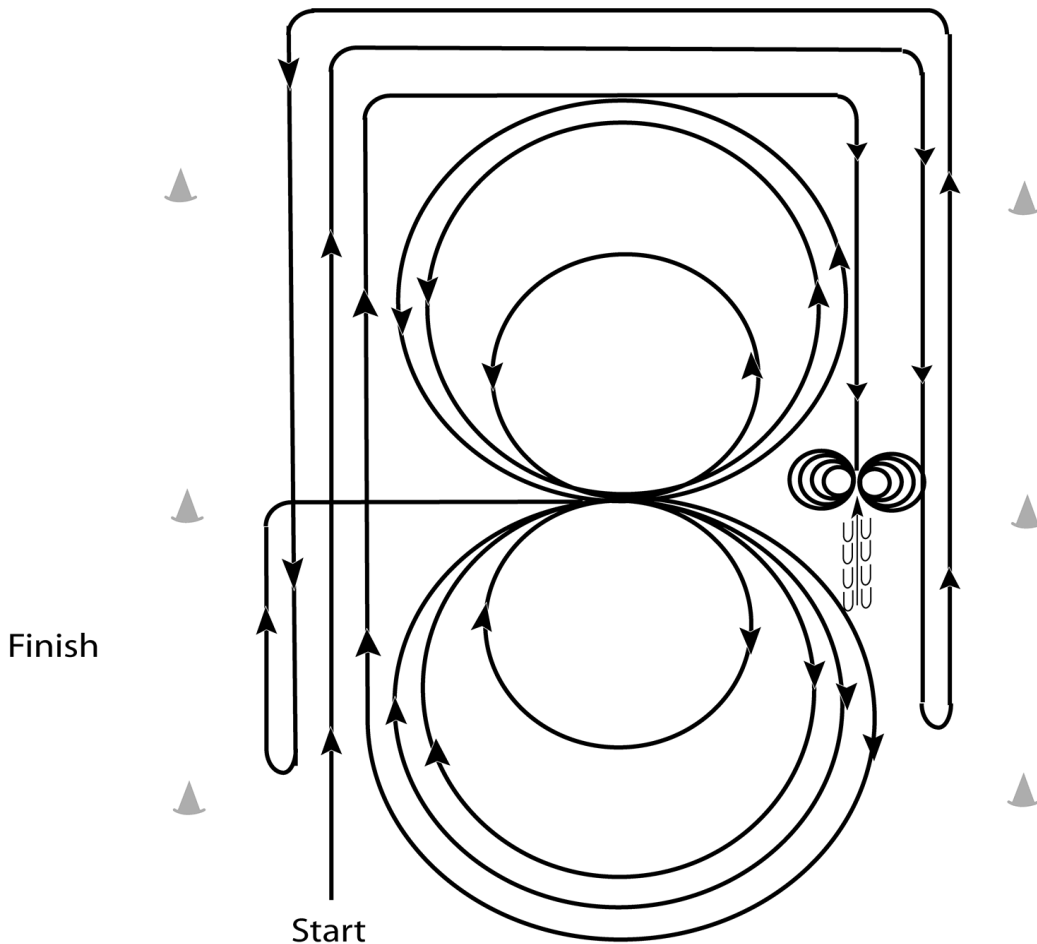

1. Beginning and staying at least twenty feet (6.09 m) from the walls or fence, lope straight up the left side of the arena, circle the top end of the arena, run straight down the opposite or right side of the arena past the center marker and do a left rollback - no hesitation.
 2. Continue straight up the right side of the arena, circle back around the top of the arena, run straight down the left side, past the center marker and do a right rollback.- no hesitation.
 3. Continue up the left side of the arena to the center marker. At the center marker, the horse should be on the right lead. Guide the horse to the center of the arena on the right lead and complete three circles to the right; the first two circles large and fast; the third circle small and slow. Change leads at the center.
 4. Complete three circles to the left; the first two circles large and fast; the third circle small and slow. Change leads at the center of the arena.
 5. Begin a large fast circle to the right but do not close this circle. Continue up the left side of the arena, circle the top of the arena, run straight down the opposite side of the arena past the center marker and do a sliding stop. Back up at least ten feet (3m). Hesitate.
 6. Complete four spins to the right.
 7. Complete four spins to the left. Hesitate to demonstrate completion of the pattern.
- Rider may dismount and drop bridle to the designated judge.

[R/NRHAP-3]

Pattern Provided by:

LCHA Ranch Reining Pattern 2

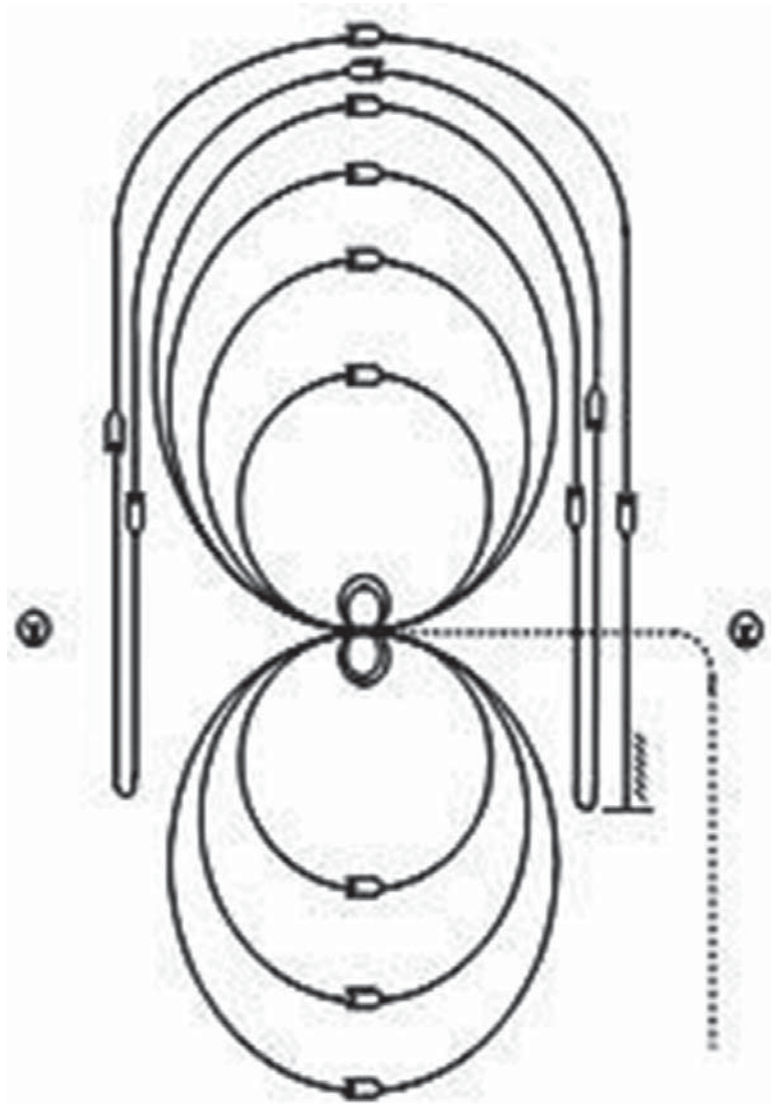

Mandatory Markers along Fence or Wall The judge shall indicate with markers on arena fence or wall the center of pattern.

Ride pattern as follows: Trot to center of arena and stop or walk before departure.

- 1.** Beginning on right lead, complete two circles to the right - the first one large and fast; the second one small and slow. Stop at center.
- 2.** Complete 4 spins to the right. Hesitate.
- 3.** Beginning on left lead, complete two circles to the left - the first one large and fast; the second one small and slow. Stop at center.
- 4.** Complete 4 spins to the left. Hesitate.
- 5.** Beginning on the right lead, complete a large fast circle to the right and change leads at center of arena. Complete a large fast circle to the left and change leads at center of arena.
- 6.** Begin a large fast circle to the right, but do not close this circle. Run down the right side of the arena, past the center marker, and do a left roll back at least 20 feet from the wall or fence.
- 7.** Continue back around the previous circle, but do not close this circle. Run down the left side of the arena, past the center marker, and do a right roll back at least 20 feet from the wall or fence.
- 8.** Continue back around previous circle, but do not close this circle. Run down right side of the arena, past the center marker, and do a sliding stop at least 20 feet from the wall or fence. Back up at least 10 feet. Hesitate to show completion of pattern.

LCHA June 2021

Western Horsemanship

Show Date: 06-12-2021

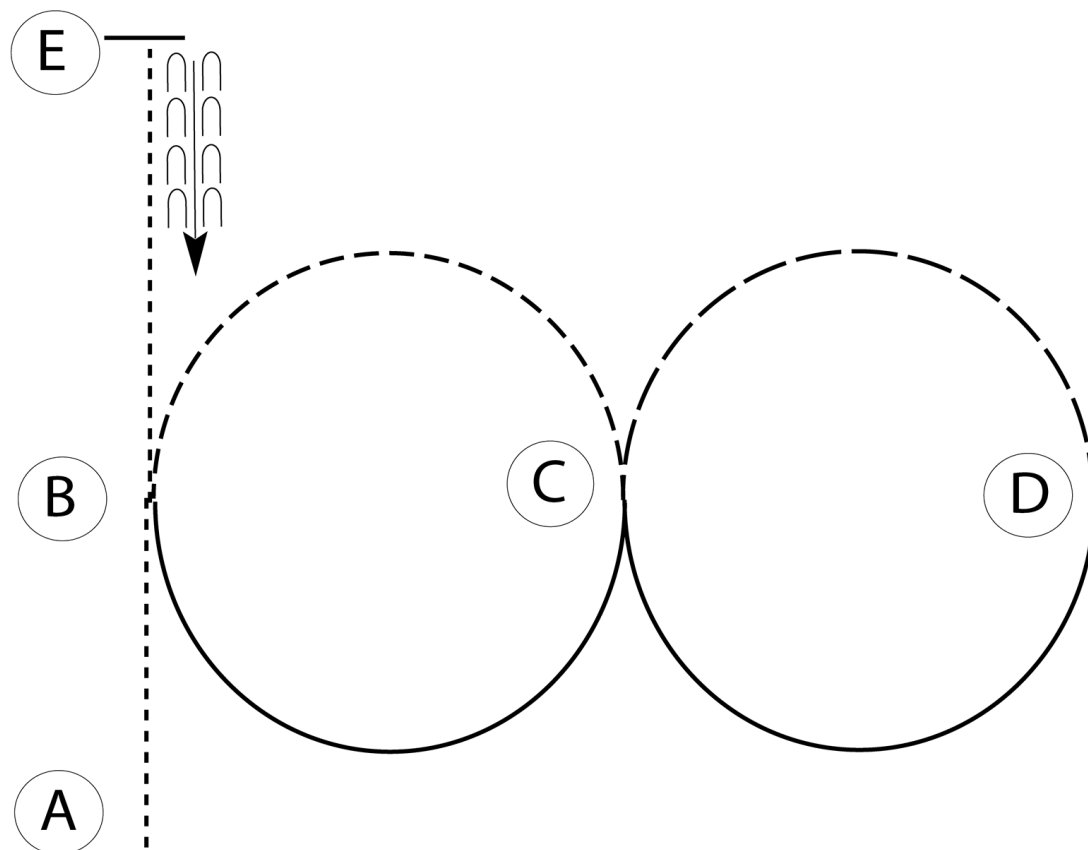

Be ready at A.

1. Walk A to B.
2. Jog a half circle to C.
3. Lope a half circle on the left lead to D.
4. Extend the jog in a half circle to C.
5. Lope a half circle on the right lead to B.
6. Walk to E.
7. Stop at E and back approximately one horse length.

Follow the instructions of your ring steward.

Walk
Jog	-----
Extended Jog	- - - - -
Lope	—————
Lead Change	——— ———
Back	← u u u u
Marker	(B)

[WH/2-3]

Pattern Provided by:

LCHA June 2021

Ranch Riding

Show Date: 06-12-2021

www.HorseShowPatterns.com

www.HorseShowPatterns.com

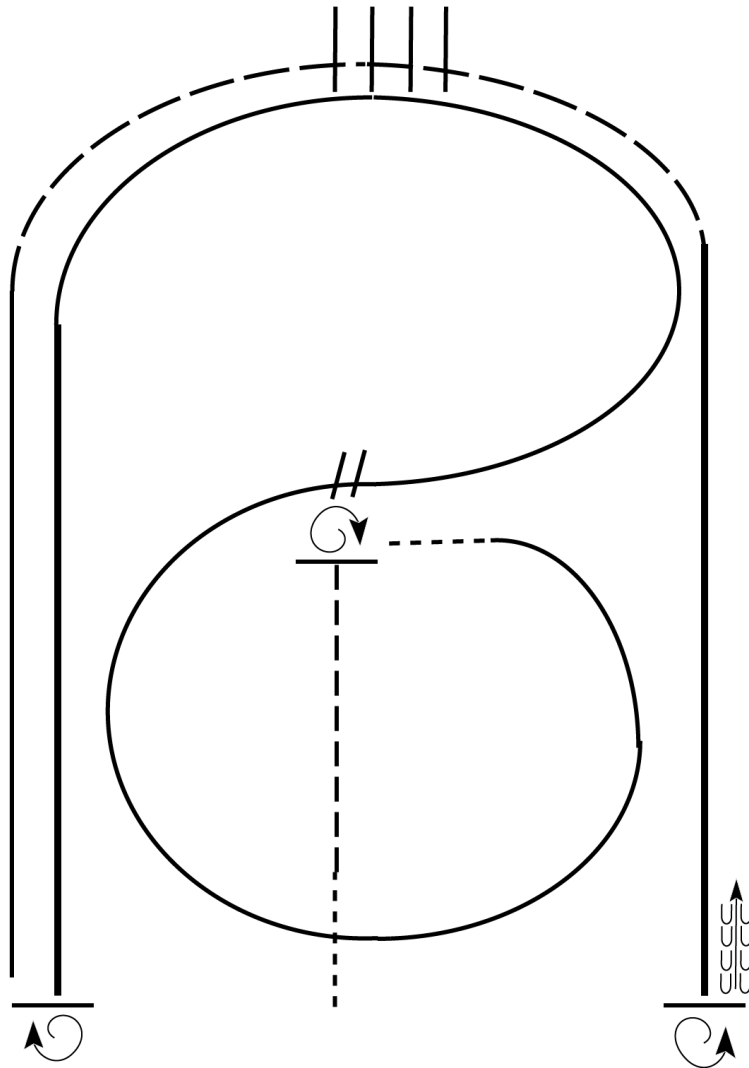

1. Walk
2. Jog
3. Stop, do a 1 1/4 turn to the right
4. Walk. Then, lope small circle on the right lead
5. Change leads, (simple or flying) lope left lead around end of the arena
6. Extend the lope on the left lead
7. Stop, do a 2 1/2 turns right
8. Lope straight on the right lead
9. Extend the jog around end of the arena across poles/logs
10. Extend the lope on right lead
11. Stop, do 2 turns left
12. Back

Walk	-----
Jog	- - - - -
Extended Jog	— — — —
Lope	—————
Lead Change	//
Back	←←←←←
Marker	(B)

[RR/6]

Pattern Provided by:

Class 56 - Walk/Trot Ground Poles
Class 57 - Ground Poles

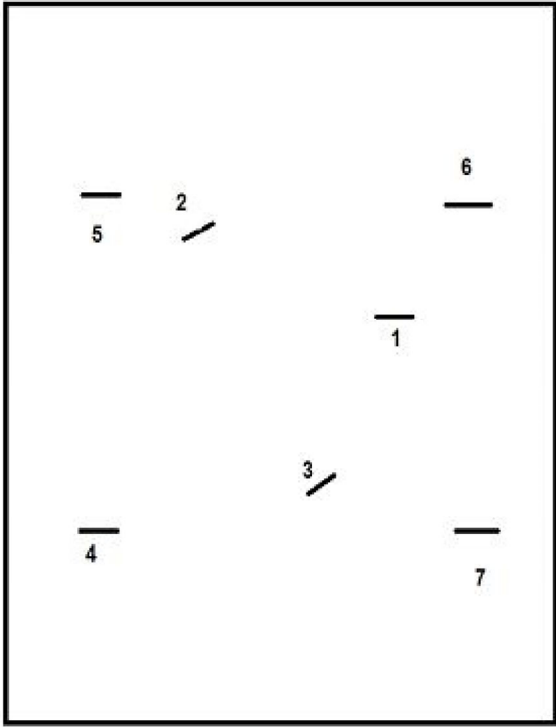

End Gate