

STAKE OUT			
A-C	6'	B-C	11' 10-3/4'
A-D	14' 5-3/4'	B-D	7' 5-1/2'
A-E	21' 10-3/4'	B-E	24' 2-1/8'
A-F	24' 5-3/4'	B-F	21' 1-1/4'
A-G		B-G	
A-H		B-H	

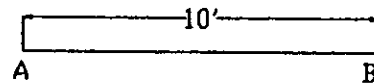

24 BAKER ST. P.O. BOX 100 HASTINGS ON KOL-1YO
705-696-2385 1-800-465-3433 FAX 705-696-1922

14'X16'X28' OYSTER

QTY.	LENGTH	RADIUS	TYPE
2	8'0"	8'0"	PLAIN
1	8'0"	8'0"	RETURN
1	3'0"	8'0"	PLAIN
1	8'0"	7'0"	RETURN
1	8'0"	7'0"	PLAIN
1	5'0"	7'0"	PLAIN
2	7'0"	NA	PLAIN
1	6'0"	NA	SKIMMER
1	6'0"	NA	PLAIN
11	-	NA	A-FRAME
1	-	NA	N&B PKG
			S.A. 379 sq.ft.
			PER 74'
1428DYSC			DATE: 06-11-00

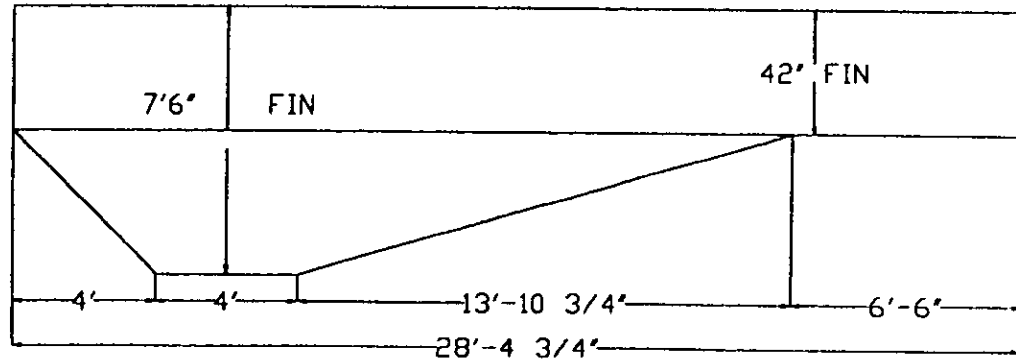

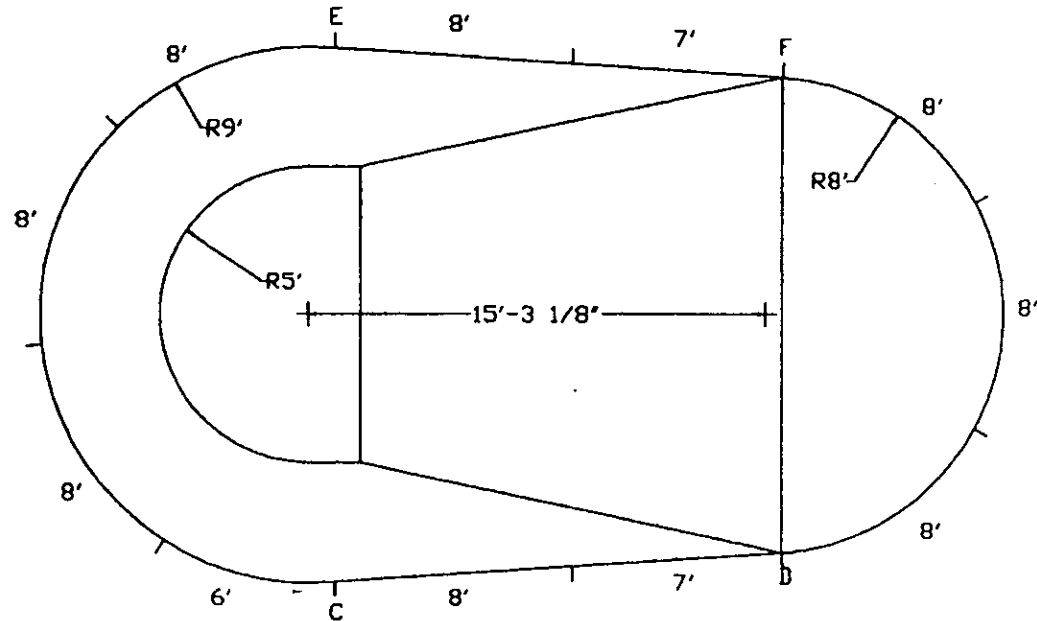
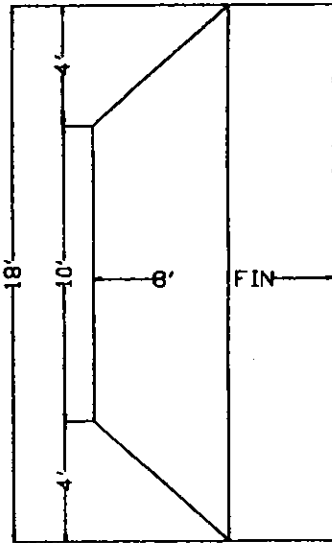

STAKE OUT			
A-C	6'	B-C	11'8"
A-D	16'6"	B-D	8'6-3/4"
A-E	23'11"	B-E	23'11"
A-F	27'4-3/4"	B-F	23'5-5/8"
A-G		B-G	
A-H		B-H	

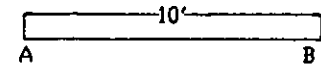

24 BAKER ST. P.O. BOX 100, HASTINGS ON KOL. 1Y0
 705-696-2305, 1-800-465-3433, FAX 705-696-1922

16'X18'X32' OYSTER

QTY.	LENGTH	RADIUS	TYPE
1	8'0"	9'0"	RETURN
2	8'0"	9'0"	PLAIN
1	6'0"	9'0"	PLAIN
1	8'0"	8'0"	RETURN
2	8'0"	8'0"	PLAIN
1	8'0"	NA	PLAIN
1	8'0"	NA	SKIMMER
2	7'0"	NA	PLAIN
11	-	NA	A-FRAME
1	-	NA	N&B PKG
			S.A. 487 sq.Ft.
			PER. 84'
16320YSC			DATE: 06-11-00

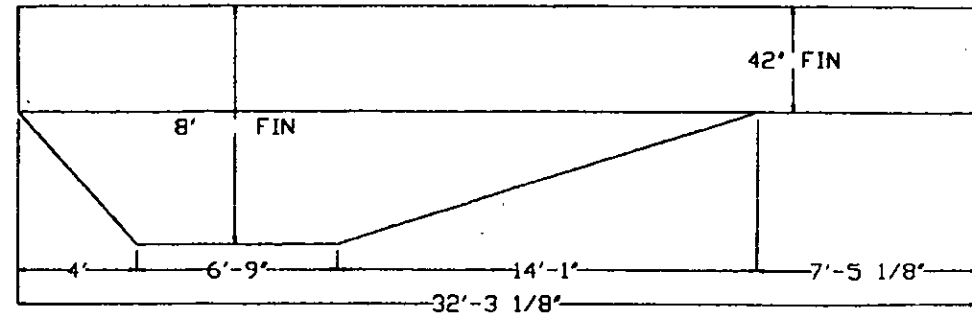

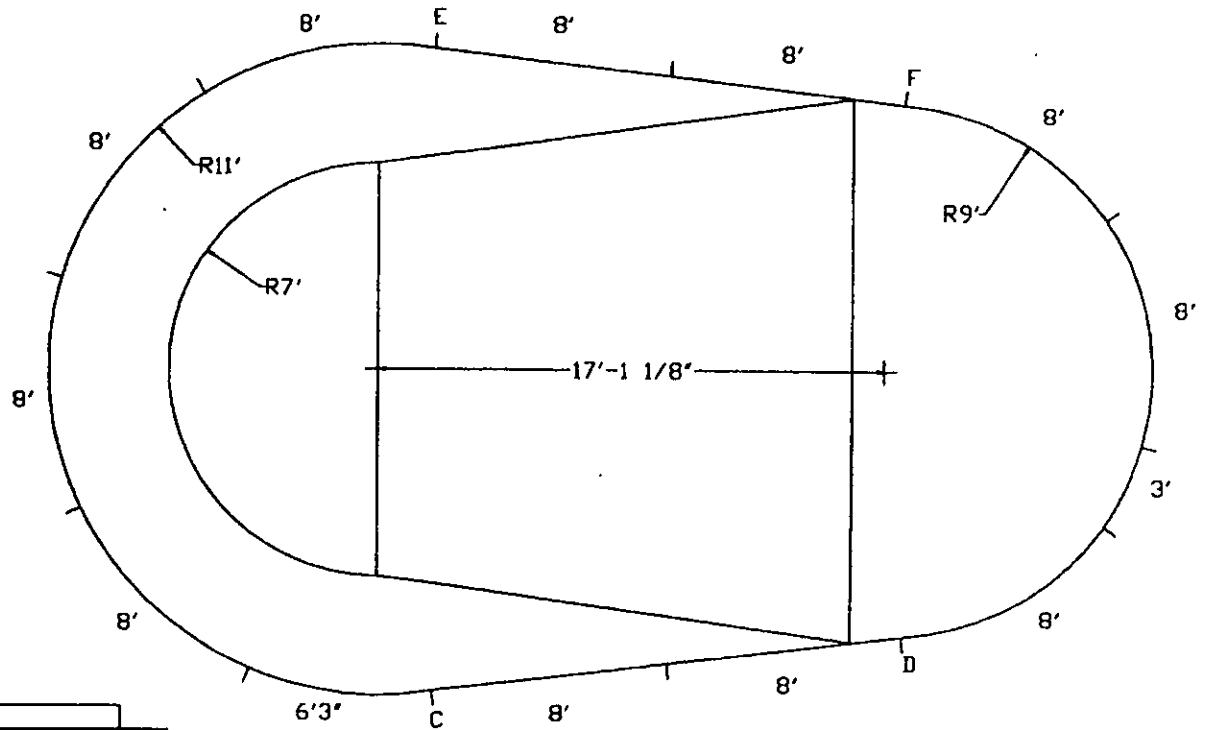
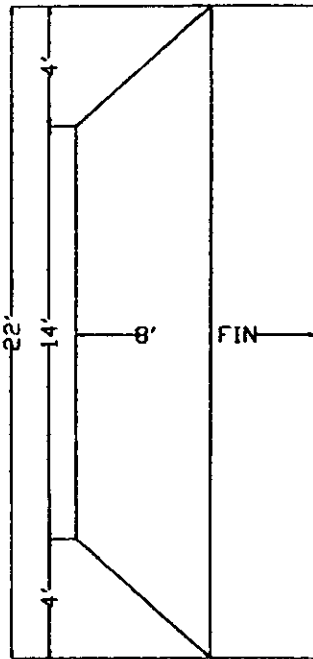

STAKE OUT			
A-C	6'	B-C	11'8"
A-D	17'8-3/4"	B-D	9'10"
A-E	27'8-1/4"	B-E	29'5-1/4"
A-F	30'3-7/8"	B-F	26'5-3/4"
A-G		B-G	
A-H		B-H	

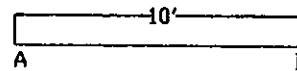

24 BAKER ST., P.O. BOX 100, HASTINGS DN, KOL-1Y0
 705-696-2385, 1-800-465-3433, FAX: 705-696-1922

18'x22'x37' OYSTER

QTY.	LENGTH	RADIUS	TYPE
1	8'0"	11'0"	RETURN
3	8'0"	11'0"	PLAIN
1	6'3"	11'0"	PLAIN
1	8'0"	9'0"	RETURN
2	8'0"	9'0"	PLAIN
1	3'0"	9'0"	PLAIN
1	8'0"	NA	SKIMMER
3	8'0"	NA	PLAIN

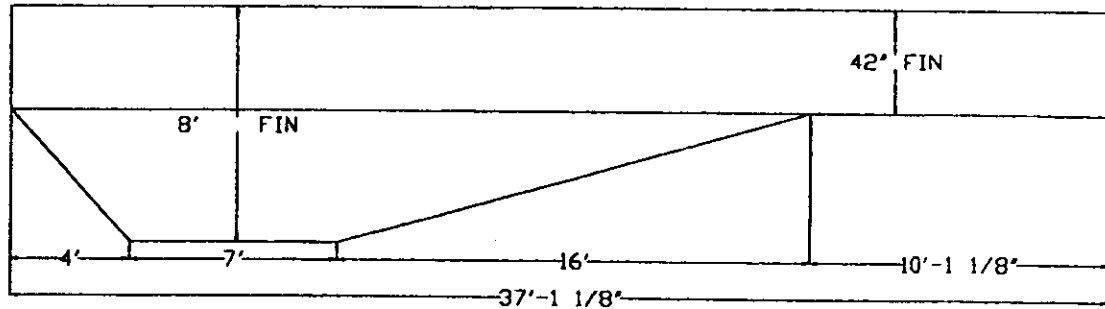

13	-	NA	A-FRAME
1	-	NA	N&B PKG
			S.A. 661 sq.ft.
			PER: 97'3"
1837DYSC			DATE: 06-11-00