

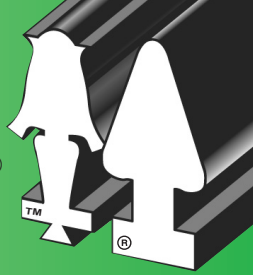

The Company With Connections®



## INCOMPARABLE PIPE-TO-MANHOLE CONNECTORS FOR SANITARY SYSTEMS

# X-CEL

### ● A•LOK X-CEL

Designed to produce a guaranteed watertight seal between pipe and concrete, the **A•LOK X-CEL** flexible pipe-to-manhole connector provides maximum performance on the job site. Its unique design not only saves valuable project time, but also ensures longevity and offers unsurpassed environmental benefits.

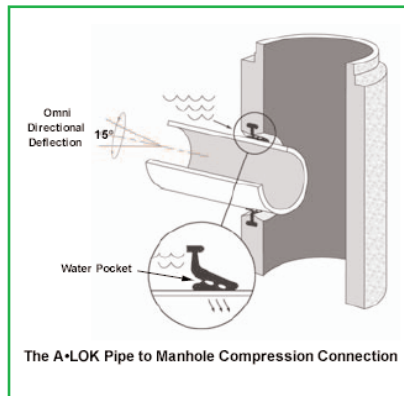

**A•LOK X-CEL** connectors prevent infiltration and ex-filtration into wastewater or stormwater systems, and are installed in the precast structure in a way that does not require coring or placement after the base component is cast. This eliminates residual waste from coring, disposal of the slugs or wasted raw material utilization or energy. Once cast-in, the connector becomes an integral component of the structure wall.

Based on the traditional **A•LOK** connector, the **X-CEL's** enhanced features improve performance. Take the patented "water pocket" for example, which utilizes the untapped pressure of ground water to exert a clamping force around the connector and pipe, allowing the connector to perform in deeper installations.

Demonstrated in tests higher than 15 psi of hydrostatic water pressure, the **X-CEL's** unique design provides 45 percent more rubber contact with the pipe, allowing for greater pipe deflection.

### ● MATERIAL

Molded or extruded from compounds formulated for wastewater applications and engineered to conform to the requirements of section 4.1.1 of ASTM C-923, the standard rubber connector is available in alternative compounds upon request. Contact an **A•LOK** representative regarding special applications, such as the presence of hydrocarbons.

### ● KEY ADVANTAGES

The **A•LOK X-CEL** offers distinct advantages for engineers, specifiers, precasters and municipalities. An enhanced profile gives the connector 45% greater rubber contact with the pipe, thus allowing the pipe to be deflected in excess of 10 degrees of omnidirectional deflection, all the while maintaining a watertight seal. These enhancements allow for more flexibility to compensate for pipe shear due to settlement or ground movement.

### ● KEY ADVANTAGES (continued)

On larger-diameter pipe, where size prohibits a gasket from being installed in a flat plane, the **X-CEL** can be configured for casting in a curve with the connector staying perpendicular to the center line of the pipe. Discovered through years of extensive research and development, the configurations cause no loss of compression or deflection.

Functioning on pure compression, the **X-CEL** allows for fast and easy field installation. After the connector and pipe are cleaned and lubricated, the pipe is simply centered in the connector and inserted. Backfilling can be done immediately, thus enhancing project safety and overcoming the typical problems of water, running sand and other unstable trench conditions.

For Specifiers, the **X-CEL** connector offers a guaranteed solution to the age-old containment system problem of the best way to connect pipes and concrete structures. Precasters using **X-CEL** connectors experience increased satisfaction due to their ability to offer a complete watertight, guaranteed product, while municipalities that install **X-CEL** will ultimately spend less on road repair by avoiding the possibility of pot/sink holes that are often the result of leaking, non-connected, systems.

### ● PRODUCT REFERENCES

#### A.) ASTM C-923

Resilient Connector Between Reinforced Concrete Manholes Structures, Pipe and Laterals.

#### B.) ASTM C-1244

Standard Test Method For Concrete Sewer Manholes by the Negative Air Pressure (Vacuum) Test

#### C.) ASTM C-478

Standard Specification for Precast Reinforced Concrete Manhole Sections

### ● PERFORMANCE STANDARD

The **A•LOK X-CEL** guaranteed Connector meets or exceeds all material and test requirements outlined in ASTM C-923: "Resilient Connectors Between Reinforced Concrete Manhole Structures, Pipes and Laterals."

Molded or extruded from compounds formulated for wastewater applications, the standard rubber connector is engineered to conform with the requirements of section 4.1.1 of ASTM C-923. Alternative compounds are available upon special request.

## ● PERFORMANCE STANDARD (continued)

### RESILIENT TEST REQUIREMENTS OF A.S.T.M. C-923

TEST	RESULTS	ASTM METHOD
Chemical resistance 1 N Sulfuric acid 1 N Hydrochloric Acid	no weight loss no weight loss	at 22°C for 48h
Tensile strength	1200 psi or 8.5 MPa, min	D 412
Elongation at break	350% min.	
Hardness	±5 from mfg's. specified hardness	D 2240 (Shore A durometer)
Accelerated oven-aging	decr. of 15%, max. of original tensile strength, decr. of 20% max. of elongation	D 573, 70±1°C for 7 days
Compression set	decr. of 25%, max. of original deflection	D 395, Method B, at 70°C for 22h
Water absorption	increase of 10%, max. of original by weight	D 471, immerse 0.75 by 2-in. or 19 by 25-mm Specimen in distilled water at 70°C for 48h
Ozone resistance	rating 0	D 1171
Low-temp brittle point	no fracture at -40°C	D 746
Tear resistance	200 lbf/in. or 34 kn/m	D 624, Method B

Copyright ASTM INTERNATIONAL. Reprinted with permission

## ● DIMENSIONAL DATA

### A•LOK X-CEL Cross Sections / Pipe Size OD's

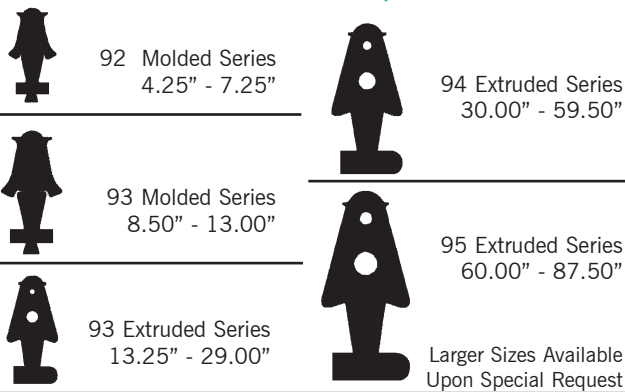

Min. distance  
between pipes is  
approx. 1/2 the  
smallest pipe OD

### MAX. PIPE SIZE OD's

Manhole Diameter	135° - 225° Pipe Angle	90° Pipe Angle
42"	26.5"	22.0"
48"	31.5"	25.0"
60"	42.0"	32.0"
72"	52.5"	38.0"
84"	59.5"	44.0"
96"	73.5"	50.0"
108"	76.0"	56.0"
120"	85.0"	62.0"

### MAX. PIPE SIZE OD's

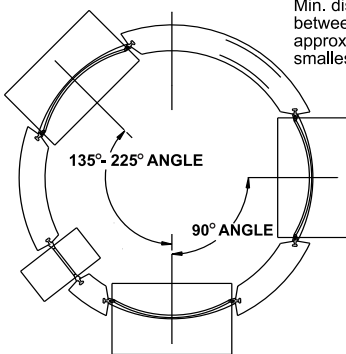

## ● PRODUCT SPECIFICATIONS

A flexible pipe to manhole connector shall be used whenever a pipe penetrates into a precast concrete manhole or structure. The connector shall be the **A•LOK X-CEL CONNECTOR** as manufactured by **A•LOK PRODUCTS, INC.**, Tullytown, PA, or approved equal.

The design of the connector shall provide a flexible, watertight seal between the pipe and concrete structure. The connector shall assure that a seal is made between:

(1) The connector and the structure wall by casting the connector integrally with the structure wall during the manufacturing process in a manner that it will not pull out during pipe coupling. The connector shall also be capable of being cast into a round structure by curving the connector in a manner that allows it to remain centrally located within the structure wall and perpendicular to the pipe. This configuration will result in no loss of seal or deflection of pipe entering a concrete structure.

(2) The seal between the connector and the pipe shall be made by the compression of the connector between the outside circumference of the pipe and the interior hole opening of the structure. The connector shall be the only component to affect the seal between the pipe and structure.

The connector shall be made from materials that conform to the physical and chemical requirements outlined in Section 4, "Materials and Manufacture" of ASTM C-923 Standard Specification for Resilient Connectors between Reinforced Concrete Manhole Structures, Pipes, and Laterals, and the overall design will meet or exceed Section 7, "Test Methods and Requirements" of ASTM C-923.

The connector shall be sized specifically for the type of pipe being used and shall be installed in accordance with the recommendations of the manufacturer.

## INSTALLATION INSTRUCTIONS

### STEP 1:

Confirm that the pipe surface is smooth, clean and free of foreign materials, chips, gouges and form seams due to manufacturing or handling. Slightly bevel any sharp or blunt edges caused by the cutting of the pipe.

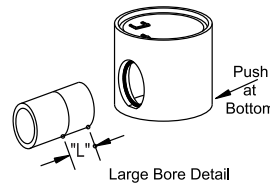

### STEP 2:

Lubricate the connector and the entire section of the pipe that will be inserted into the connector. The chart below lists A-LOK's minimum lubrication length "L".

PIPE SIZE	MIN. LUBRICATION LENGTH "L"
4" - 15"	12"
16" - 18"	18"
21" & Larger	24"

### STEP 3:

Center the pipe and connector square to each other and insert the pipe into the connector using a bar or back hoe depending on the size. Once the pipe is coupled with the connector, deflect the structure or pipe to achieve the proper angle.

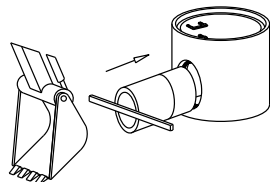

### WARNING

To ensure the A-LOK X-CEL Connector remains a flexible watertight connector, it is A-LOK Products, Inc. strong recommendation that no mortar be placed between the pipe and wall of the concrete structure. The use of mortar in this area would decrease the effectiveness of the connector to compensate for shear caused by settlement or ground movement.

### NOTE:

To find approximate subgrade, measure from the outside base of the structure to the junction of the connector and flat spot. Then add the wall thickness of the pipe plus 1/4 inch.

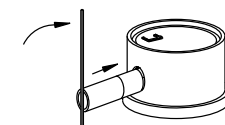
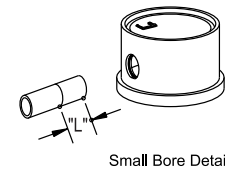

### CAUTION:

When installing pipe stubs for future pipeline installation, all stubs must be properly restrained to prevent any movement by means other than the **A•LOK X-CEL Connector**.

